

DK-LOK

Fittings & Valves

DK-Lok Tube & Pipe Fittings

No. 10-01



Tube & Pipe Fittings

90° Elbow(Long / Short)
EB / SEB  **07**

45° Long Elbow
HEB  **07**

Equal Tee(Standard / Short)
ETB / STB  **08**

Cap
CPB  **08**

Reducer(Con / Ecc)
RCB / REB  **09**

Joint Reducer(Male / Female)
JRM / JRF  **09**

Cap Reducer
RCB  **10**

Reducing Tee
RTB  **11**

Joint Tee(Male / Female)
JTM / JTF  **12**

Joint Cap(Male / Female)
JCM / JCF  **12**

Multi-Header Tee
MHT  **13**

Multi-Header Joint Tee
MJT  **13**

Flange Connection

Lap Joint
LAJ  **14**

Pipe Flange
PF  **14**

JIS RF Flange / JIS Blind Flange
RFF / BLF  **15**

Teflon Gasket
TG  **15**

Coaxial Fittings

Coaxial 90° Elbow
CLE  **16**

Coaxial 45° Elbow
CHE  **16**

Coaxial Equal Tee
CET  **16**

Coaxial Reducing Tee
CRT  **17**

Coaxial Sleeve
CSL  **17**

Coaxial Reducer
CRC  **18**

Coaxial Terminator
CTR  **18**

Ordering Information

DK-Lok Tube & Pipe Fittings are ordered by product code shown below.

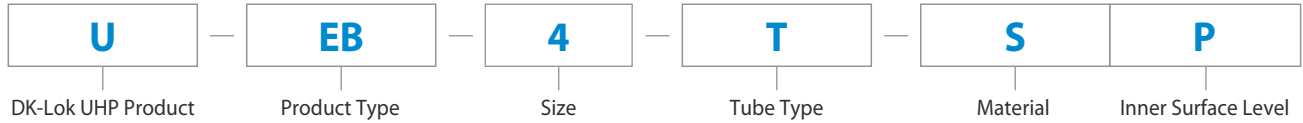

	S16T-EB-B	S50X8T-RT-AP	S50-SEB-P
Material	SUS316L	SUS316L	SUS316L
Size	1"	50A x 1/2"	50A
Tube Type	Tube	Pipe x Tube	Pipe
Product	90° Long Elbow	Reducing Tee	90° Short Elbow
Inner Surface Level	BA	AP	EP

Material		Size		Tube Type		Product Type			Inner Surface Level		
S	SUS316L	4	1/4"	T	Tube	EB	90° Long Elbow			AP	AP
4S	SUS304	6	3/8"	P	Pipe	SEB	90° Short Elbow			MP	MP
		8	1/2"			HEB	45° Long Elbow			B	BA
		10	5/8"			ETB	Equal Tee			P	EP
		12	3/4"			STB	Equal Short Tee				
		16	1"			RTB	Reducing Tee				
		20	1 1/4"			RCB	Concentric Reducer				
		24	1 1/2"			REB	Eccentric Reducer				
		32	2"			CPB	Cap				
		40	2 1/2"			RCB	Cap Reducer				
		48	3"			JTM	Joint Tee(Male)				
		64	4"			JTF	Joint Tee(Female)				
		80	5"			JRM	Joint Reducer(Male)				
		96	6"			JRF	Joint Reducer(Female)				
		xxxA	PIPE SIZE			JCM	Joint Cap(Male)				
						JCF	Joint Cap(Female)				
						TG	Teflon Gasket				
						PF	Pipe Flange				
						RFF	JIS RF Flange				
						BLF	JIS Blind Flange				
						LAJ	Lap Joint				
						MHT	Multi-Header Tee				
						MJT	Multi-Header Joint Tee				
						CLE	Coaxial 90° Elbow				
						CHE	Coaxial 45° Elbow				
						CET	Coaxial Equal Tee				
						CRT	Coaxial Reducing Tee				
						CSL	Coaxial Sleeve				
						CRC	Coaxial Reducer				
						CTR	Coaxial Terminator				

Tube & Pipe Size

Pipe Size (A Size)

(Unit = mm)

Normal Pipe	Ouside Diameter at End	Wall Thickness at End		Straight End Length	Thinning Length	
	O.D (O.D1, O.D2)	T		L	J	
		5S	10S		5S	10S
8A	13.8	1.2	1.65	29.0	4.0	7.0
10A	17.3	1.2	1.65	36.0	4.0	7.0
15A	21.7	1.65	2.1	36.0	5.0	7.0
20A	27.2	1.65	2.1	36.0	5.0	7.0
25A	34.0	1.65	2.8	36.0	5.0	7.0
32A	42.7	1.65	2.8	46.0	5.0	7.0
40A	48.6	1.65	2.8	46.0	5.0	7.0
50A	60.5	1.65	2.8	46.0	5.0	7.0
65A	76.3	2.1	3.0	51.0	6.0	11.0
80A	89.1	2.1	3.0	51.0	6.0	11.0
100A	114.3	2.1	3.0	51.0	6.0	11.0
125A	139.8	2.8	3.4	-	7.0	-
150A	165.2	2.8	3.4	-	7.0	-
200A	216.3	2.8	4.0	-	7.0	-
250A	267.4	3.4	4.0	-	-	-
300A	318.5	4.0	4.5	-	-	-
350A	355.6	4.0	4.8	-	-	-
400A	406.4	4.2	4.8	-	-	-
450A	457.2	4.2	4.8	-	-	-
500A	508.0	4.8	5.5	-	-	-
550A	558.8	4.8	5.5	-	-	-
600A	609.6	5.5	6.4	-	-	-

Tube Size (Inch Size)

(Unit = mm)

Normal Pipe	Ouside Diameter at End	Wall Thickness at End	Straight End Length	Thinning Length
	O.D (O.D1, O.D2)	T (T1, T2)	L	J
1/8"	3.18	0.7	29.0	7.0
1/4"	6.35	1.0(0.89)	29.0	7.0
3/8"	9.53	1.0(0.89)	29.0	7.0
1/2"	12.7	1.0, 1.24(1.65)	29.0	7.0
5/8"	15.88	1.0(1.24)	36.0	7.0
3/4"	19.05	1.65(1.24)	36.0	7.0
1"	25.4	1.65(1.24)	36.0	7.0
1 1/4"	31.8	1.65	36.0	7.0
1 1/2"	38.1	1.65	46.0	7.0
2"	50.8	1.65	46.0	7.0
2 1/2"	63.5	1.65	51.0	7.0
3"	76.2	1.65	51.0	11.0
4"	101.6	2.11	51.0	11.0
5"	127.0	2.77, 3.05	56.0	11.0
6"	152.4	2.77, 3.05	56.0	11.0

Weld Bevel End Manufacture Form

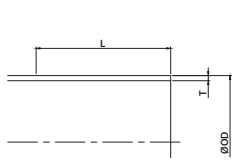
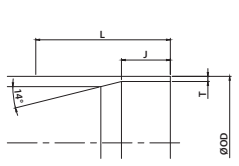
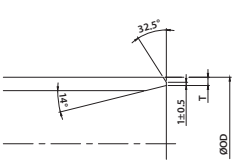
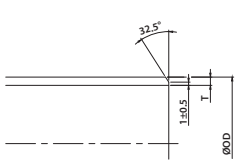
Type \ Form	Automatic Welding		Manual Welding	
				
Elbow (Long/Short)	8A~100A	-	125A~600A	-
Equal Tee (Long/Short)	8A~65A	80A~100A	125A~600A	-
Reducing Tee	8A~100A	-	-	125A~600A
Cap	-	15A~100A	125A~600A	-
Cap Reducer	15A~32A	40A~100A	125A~600A	-
Concentric Reducer	15A~100A	-	125A~600A	-
Eccentric Reducer	15A~100A	-	125A~600A	-

Dimensional Tolerance

Item	Products	Normal Pipe Size			
		1/8"~3/8"	8A~10A 1/2"~3/4"	15A~65A 1"~3"	80A~200A 4"~6"
Pipe Fittings Header Joint-Header Multi-Tee	Outside Diameter at End	± 0.1mm	± 1%		
	Wall Thickness at End	Either Bigger ± 0.2mm or ± 20%			
	Straight End Length	+ Not Specified -0.4mm			
	Thinning Length	+ Not Specified -0			
Elbow, 45° Elbow	Bend Radius	± 0.8mm	± 1.6mm	± 3.2mm	
Elbow, 45° Elbow Tee, Joint-Tee Multi-Header Tee Joint-Header, Multi-Tee	Center to End	± 0.8mm	± 1.6mm	± 3.2mm	
Lap Joint Pipe Flange	Length	± 0.8mm	± 1.6mm	± 3.2mm	
Cap	Back to End	± 0.8mm	± 3.2mm		
Reducer, Cap Reducer Joint Reducer, Joint Cap Outside-Diameter-Changeable Fitting Wall-Thickness-Changeable Fitting	Over All Length	± 0.8mm	± 1.6mm	± 3.2mm	
Lap Joint	Thickness of Lap		10A	+ 1.6mm	
				- 0	
Lap Joint	Diameter of Lap		10A	+ 0mm	+ 0mm
				- 0.8	- 1.6
Header	Length of End	± 1.6mm			
Joint-Header	Branch Pitch	± 1.6mm		± 3.2mm	
Multi-Tee	Total Length	+ 5mm			
		- 0			

Production Process

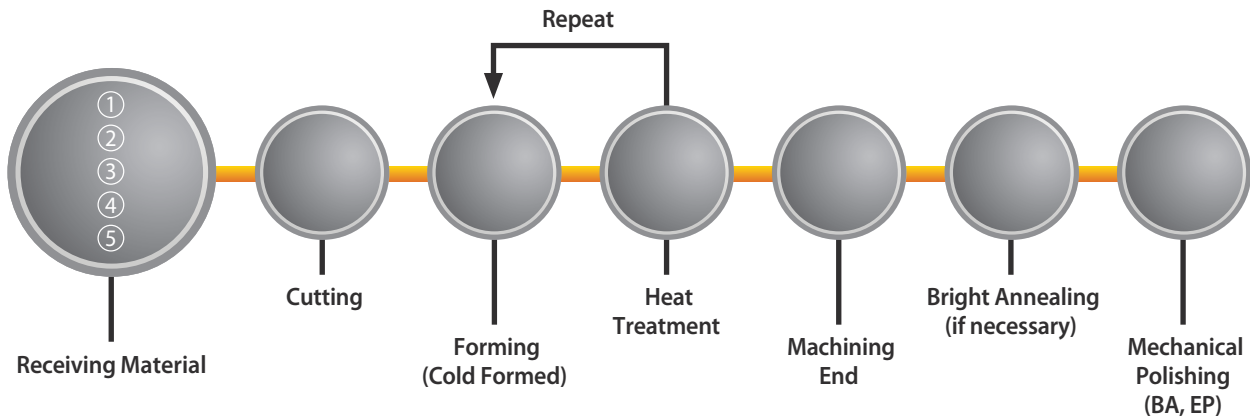

- ① ELBOW
- ② CAP
- ③ REDUCER
- ④ LAP JOINT
- ⑤ COAXIAL ELBOW

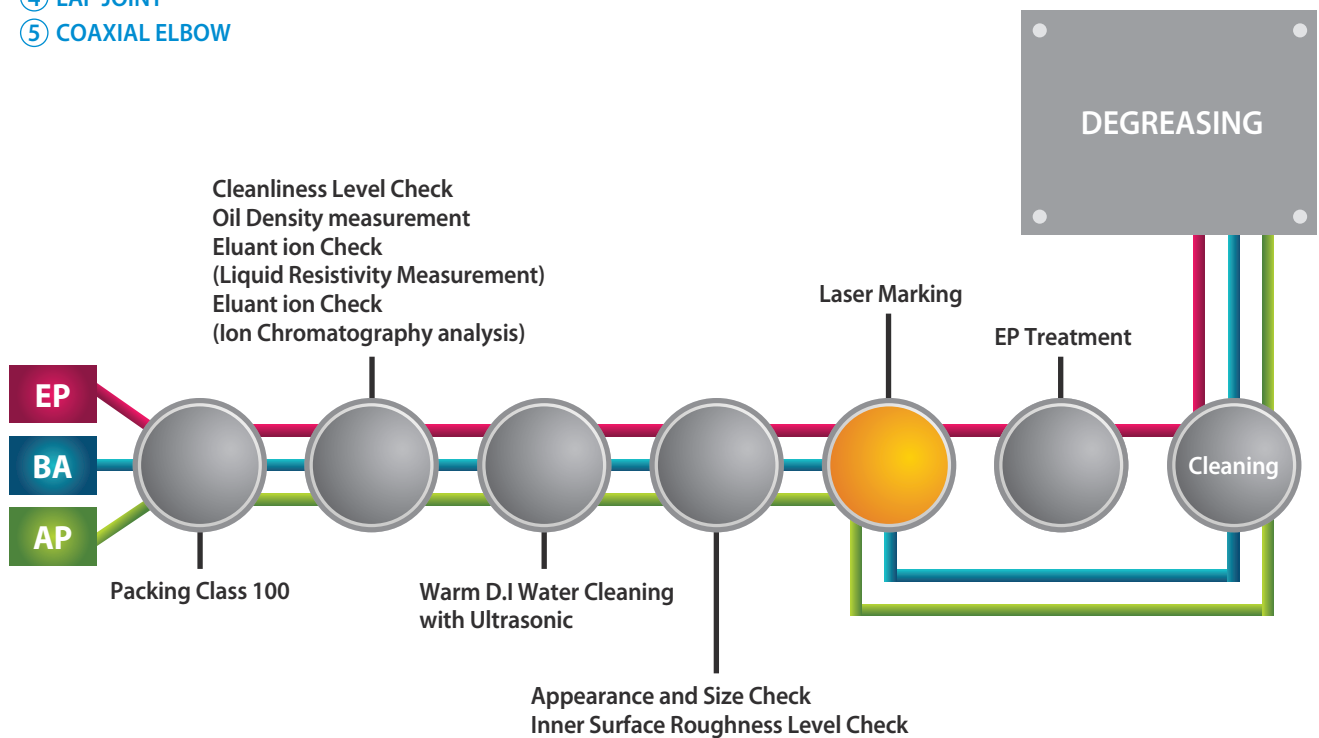

Production Process

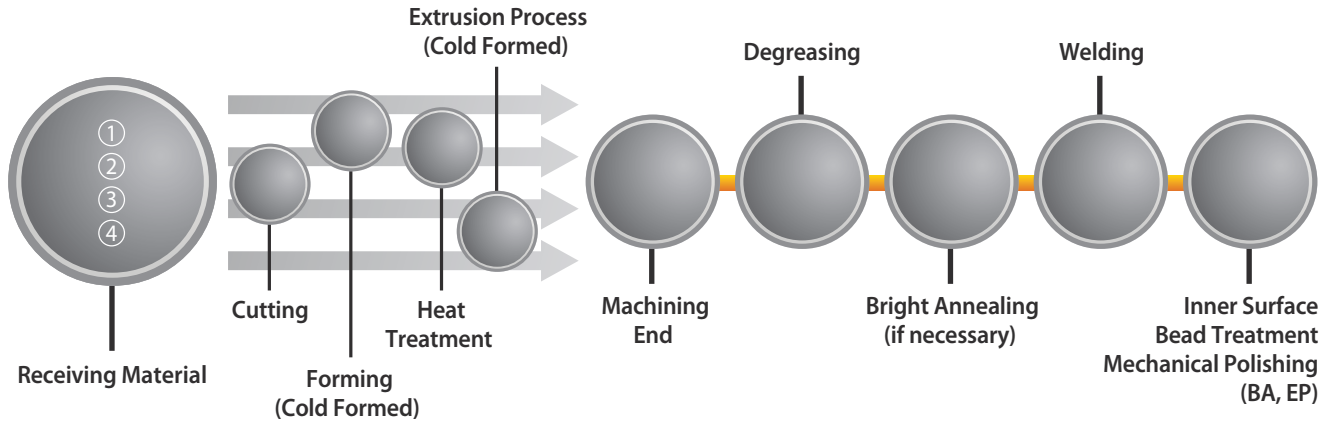

- ① PIPE FLANGE
- ② JOINT REDUCER
- ③ CAP REDUCER, JOINT CAP
- ④ TEE, JOINT TEE, MULTI HEADER TEE, COAXIAL TEE

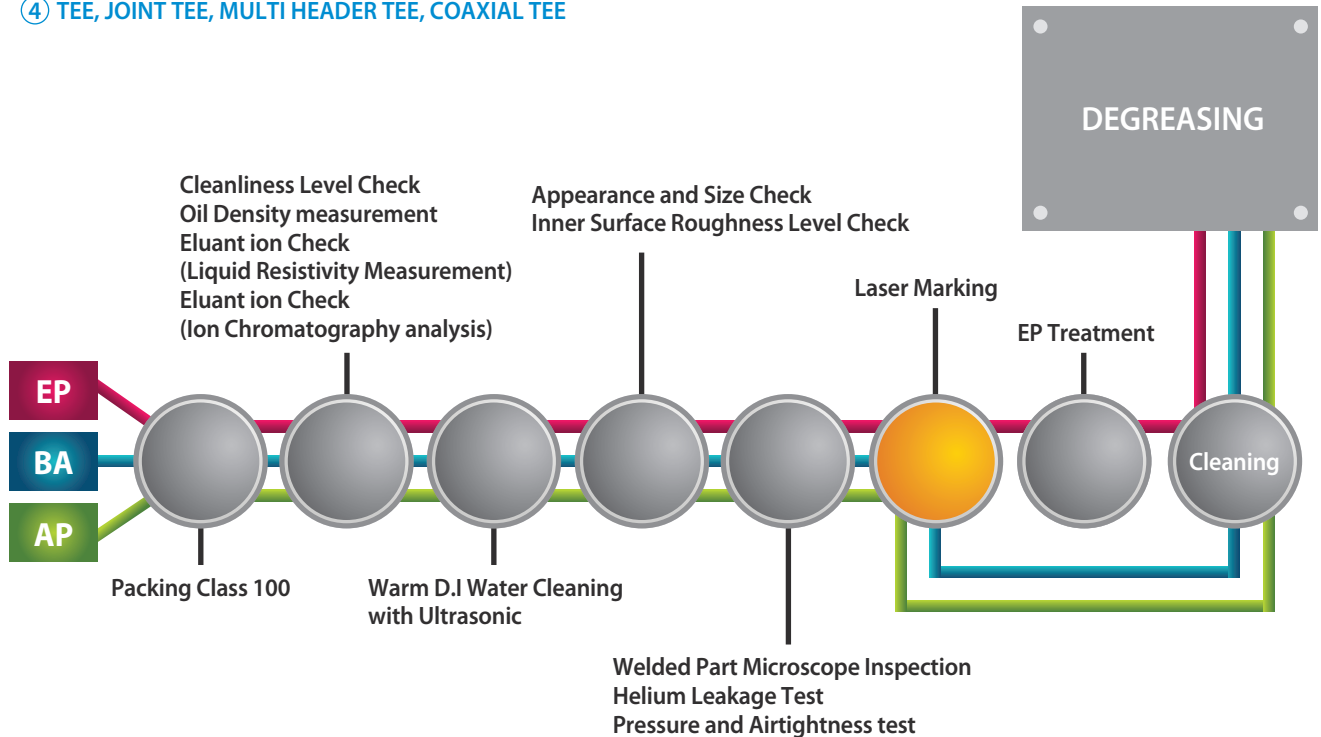

Tube & Pipe Fittings

90° Elbow(Long / Short)

EB / SEB

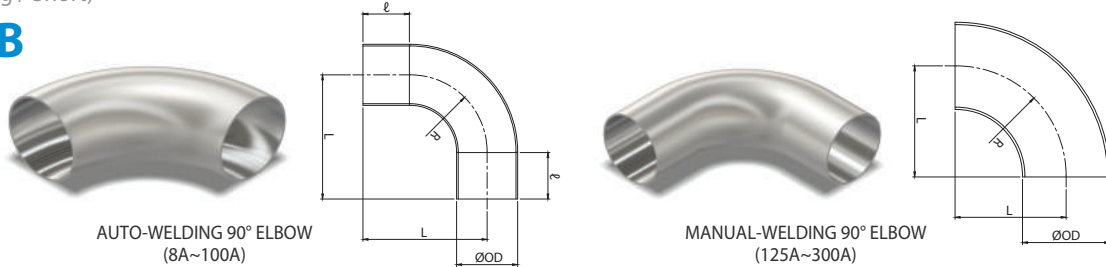

LONG RADIUS

(Unit = mm)

Pipe Size (A Size)																
O.D	8A	10A	15A	20A	25A	32A	40A	50A	65A	80A	100A	125A	150A	200A	250A	300A
R	25.4	25.4	38.1	38.1	38.1	47.6	57.2	76.2	63.5	76.2	101.6	190.5	228.6	304.8	381.0	457.2
L	55.0	62.0	75.0	75.0	75.0	94.0	104.0	123.0	147.0	166.0	204.0	-	-	-	-	-
ℓ	29.0	36.0	36.0	36.0	36.0	46.0	46.0	46.0	51.0	51.0	51.0	-	-	-	-	-

Tube Size (Inch Size)																
O.D	1/4"	3/8"	1/2"	5/8"	3/4"	1"	1 1/4"	1 1/2"	2"	2 1/2"	3"	4"	5"	6"		
R	20.0	23.0	25.0	28.0	30.0	33.0	47.6	57.2	76.2	95.3	95.3	133.4	190.5	228.6		
L	49.0	52.0	54.0	64.0	66.0	69.0	84.0	104.0	123.0	147.0	147.0	185.0	250.0	290.0		
ℓ	29.0	29.0	29.0	36.0	36.0	36.0	36.0	46.0	46.0	51.0	51.0	51.0	56.0	56.0		

SHORT RADIUS

Pipe Size (A Size)																
O.D	8A	10A	15A	20A	25A	32A	40A	50A	65A	80A	100A	125A	150A	200A	250A	300A
R	12.7	12.7	12.7	19.1	25.4	31.8	38.1	50.8	63.5	76.2	101.6	127.0	152.4	203.2	254.0	304.8
L	42.0	49.0	49.0	56.0	62.0	78.0	85.0	97.0	115.0	128.0	153.0	-	-	-	-	-
ℓ	29.0	29.0	29.0	36.0	36.0	36.0	36.0	46.0	46.0	51.0	51.0	-	-	-	-	-

45° Long Elbow

HEB

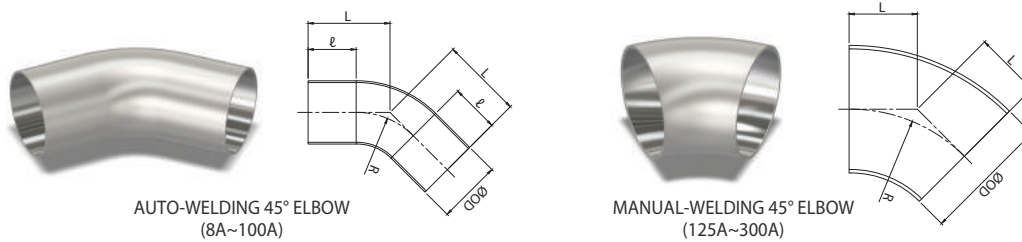

LONG RADIUS

(Unit = mm)

Pipe Size (A Size)																
O.D	8A	10A	15A	20A	25A	32A	40A	50A	65A	80A	100A	125A	150A	200A	250A	300A
R	25.4	25.4	38.1	38.1	38.1	47.6	57.2	76.2	95.3	114.3	152.4	190.5	228.6	304.8	381.0	457.2
L	40.0	47.0	52.0	52.0	52.0	66.0	70.0	78.0	91.0	99.0	115.0	78.9	94.7	126.2	157.8	189.4
ℓ	29.0	36.0	36.0	36.0	36.0	46.0	46.0	46.0	51.0	51.0	51.0	-	-	-	-	-

Tube Size (Inch Size)																
O.D	1/4"	3/8"	1/2"	5/8"	3/4"	1"	1 1/4"	1 1/2"	2"	2 1/2"	3"	4"	5"	6"		
R	20.0	23.0	25.0	28.0	30.0	33.0	47.6	57.2	76.2	95.3	95.3	133.4	190.5	228.6		
L	38.0	39.0	40.0	48.0	49.0	50.0	56.0	70.0	78.0	91.0	91.0	107.0	140.0	155.0		
ℓ	29.0	29.0	29.0	36.0	36.0	36.0	36.0	46.0	46.0	51.0	51.0	51.0	56.0	56.0		

Equal Tee(Standard / Short)

ETB / STB

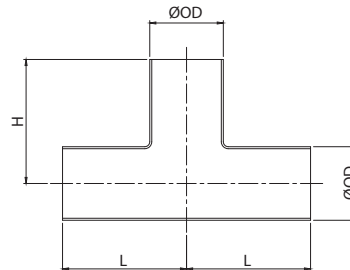
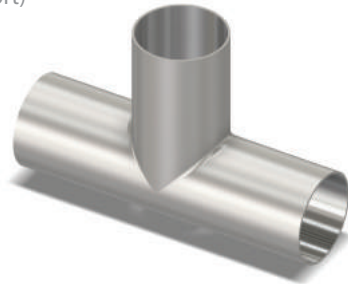

STANDARD TEE

(Unit = mm)

Pipe Size (A Size)																
O.D	8A	10A	15A	20A	25A	32A	40A	50A	65A	80A	100A	125A	150A	200A	250A	300A
L	42.0	49.0	59.0	65.0	68.0	88.0	95.0	102.0	121.0	130.0	145.0	124.0	143.0	178.0	216.0	254.0
H	42.0	49.0	59.0	65.0	68.0	88.0	95.0	102.0	121.0	130.0	145.0					

Tube Size (Inch Size)															
O.D	1/4"	3/8"	1/2"	5/8"	3/4"	1"	1 1/4"	1 1/2"	2"	2 1/2"	3"	4"	5"	6"	
L	35.0	37.0	39.0	49.0	52.0	55.0	59.0	74.0	77.0	90.0	121.0	132.0	140.0	160.0	
H	35.0	37.0	39.0	49.0	52.0	55.0	59.0	74.0	77.0	90.0	121.0	132.0	140.0	160.0	

SHORT TEE

Pipe Size (A Size)										
O.D	15A	20A	25A	32A	40A	50A	65A	80A	100A	
L	52.0	55.0	59.0	74.0	77.0	83.0	97.0	103.0	116.0	
H	52.0	55.0	59.0	74.0	77.0	83.0	97.0	103.0	116.0	

Cap

CPB

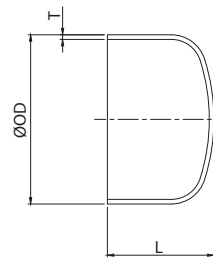

(Unit = mm)

Pipe Size (A Size)																
O.D	8A	10A	15A	20A	25A	32A	40A	50A	65A	80A	100A	125A	150A	200A	250A	300A
L	12.7	19.1	25.4	25.4	38.1	38.1	38.1	38.1	38.1	50.8	63.5	76.2	88.9	101.6	127.0	152.4
T	1.20	1.20	1.65	1.65	1.65	1.65	1.65	1.65	2.10	2.10	2.10	3.40	3.40	4.00	4.00	4.50

Tube Size (Inch Size)													
O.D	1/4"	3/8"	1/2"	5/8"	3/4"	1"	1 1/4"	1 1/2"	2"	2 1/2"	3"	4"	
L	12.7	12.7	12.7	12.7	19.1	25.4	38.1	38.1	38.1	38.1	38.1	63.5	
T	1.00	1.00	1.24	1.24	1.65	1.65	1.65	1.65	1.65	1.65	1.65	2.11	

Reducer(Con / Ecc)

RCB / REB

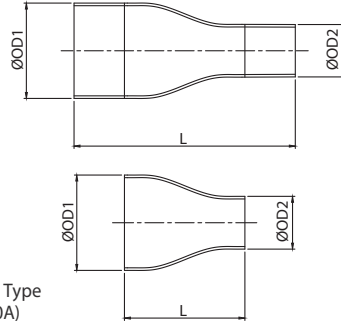

Auto Welding & Mechanical Working Type
Concentric Reducer [RCB] (8A~100A)

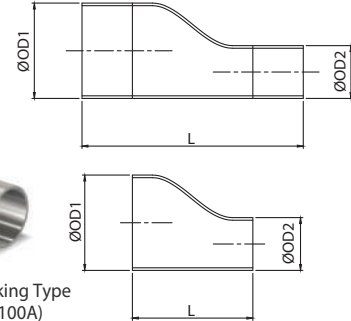

Auto Welding & Mechanical Working Type
Eccentric Reducer [RCB] (8A~100A)

AUTO WELDING TYPE CONENMTRIC REDUCER / ECCENTRIC REDUCER

(Unit = mm)

Pipe Size (A Size)					
O.D1	O.D2	L	O.D1	O.D2	L
20A	15A	105.0	50A	40A, 32A, 25A	140.0
25A	20A, 15A	120.0	65A	50A, 40A, 32A	165.0
32A	25A, 20A, 15A	125.0	80A	65A, 50A, 40A	170.0
40A	32A, 25A, 20A	130.0	100A	80A, 65A, 50A	180.0

MECHANICAL WORKING TYPE CONCENTRIC REDUCER / ECCENTRIC REDUCER

(Unit = mm)

Tube Size (Inch Size)					
O.D1	O.D2	L	O.D1	O.D2	L
15A	3/4", 1/2"	100.0	32A	1 1/2", 1 1/4", 1"	125.0
20A	1", 3/4", 1/2"	105.0	40A	1 1/2", 1 1/4", 1", 3/4", 1/2", 3/8"	130.0
25A	1", 3/4", 1/2", 3/8", 1/4"	120.0	50A	2", 1 1/2", 1 1/4", 1", 3/4"	140.0

Joint Reducer(Male / Female)

JRM / JRF

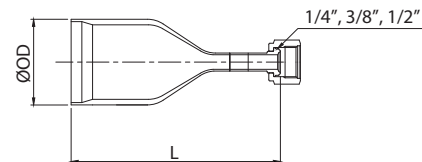
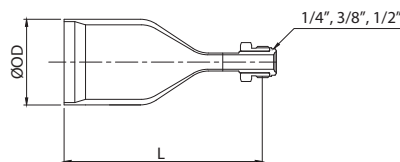

(Unit = mm)

Pipe Size (A Size)						
O.D		8A	10A	15A	20A	25A
Femal	L	90.0	100.0	110.0	115.0	130.0
Male	L	100.0	110.0	120.0	125.0	140.0
Tube Size (Inch Size)						
O.D		3/8"	1/2"	5/8"	3/4"	1"
Femal	L	80.0	85.0	100.0	110.0	115.0
Male	L	90.0	95.0	110.0	120.0	125.0

Cap Reducer

RCB

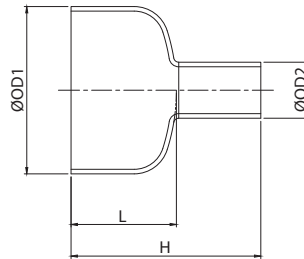

(Unit = mm)

Pipe Size (A Size)							
O.D1	O.D2	L	H	O.D1	O.D2	L	H
15A	8A, 1/2", 3/8", 1/4"	25.4	60.0	125A	8A, 1/2", 3/8", 1/4"	76.2	120.0
	10A, 3/4", 5/8"		(67.0)		130.0		
20A	8A, 1/2", 3/8", 1/4"	25.4	60.0		50A, 40A, 32A, 2", 1 1/2"		140.0
	15A, 10A, 1", 3/4", 5/8"		67.0		(150.0)		
25A	8A, 1/2", 3/8", 1/4"	38.1	73.0	150A	8A, 1/2", 3/8", 1/4"	88.9	130.0
	20A, 15A, 10A, 1 1/4", 1", 3/4", 5/8"		(80.0)		140.0		
32A	8A, 1/2", 3/8", 1/4"	38.1	73.0		50A, 40A, 32A, 2", 1 1/2"		150.0
	25A, 20A, 15A, 10A, 1 1/4", 1", 3/4", 5/8"		80.0		160.0		
40A	8A, 1/2", 3/8", 1/4"	38.1	73.0	200A	8A, 1/2", 3/8", 1/4"	101.6	140.0
	25A, 20A, 15A, 10A, 1 1/4", 1", 3/4", 5/8"		80.0		150.0		
	32A, 1 1/2"		(90.0)		160.0		
50A	8A, 1/2", 3/8", 1/4"	38.1	73.0		100A, 80A, 65A, 4", 3", 2 1/2"		170.0
	25A, 20A, 15A, 10A, 1 1/4", 1", 3/4", 5/8"		80.0	127.0	180.0		
	40A, 32A, 2", 1 1/2"		(90.0)		190.0		
65A	8A, 1/2", 3/8", 1/4"	38.1	73.0	250A	8A, 1/2", 3/8", 1/4"	152.4	200.0
	25A, 20A, 15A, 10A, 1 1/4", 1", 3/4", 5/8"		80.0		210.0		
	50A, 40A, 32A, 2", 1 1/2"		(90.0)	300A	200.0		
	2 1/2"		(100.0)		220.0		
80A	8A, 1/2", 3/8", 1/4"	50.8	85.0	25A, 20A, 15A, 10A, 1", 3/4"	230.0		
	25A, 20A, 15A, 10A, 1 1/4", 1", 3/4", 5/8"		92.0	210.0			
	50A, 40A, 32A, 2", 1 1/2"		102.0	220.0			
	65A, 3", 2 1/2"		(110.0)	230.0			
100A	8A, 1/2", 3/8", 1/4"	63.5	98.0	300A	8A, 1/2", 3/8", 1/4"	152.4	200.0
	25A, 20A, 15A, 10A, 1 1/4", 1", 3/4", 5/8"		105.0		210.0		
	50A, 40A, 32A, 2", 1 1/2"		115.0		220.0		
	80A, 65A, 4", 3", 2 1/2"		125.0		230.0		

*125A(100A, 80A, 65A, 50A) / 150A(125A, 100A, 80A, [65A]) / 200A(150A, 125A, 100A) Bevel end at large dia. Side.

Tube Size (Inch Size)							
O.D1	O.D2	L	H	O.D1	O.D2	L	H
3/4"	1/2", 3/8", 1/4", 8A	19.1	54.0	3"	1/2", 3/8", 1/4", 8A	38.1	73.0
	5/8", 10A		60.0		80.0		
1"	1/2", 3/8", 1/4", 8A	25.4	60.0		1 1/4", 1", 3/4", 5/8", 25A, 20A, 15A, 10A		(90.0)
	3/4", 5/8", 15A, 10A		67.0		(95.0)		
1 1/4"	1/2", 3/8", 1/4", 8A	38.1	73.0	4"	1/2", 3/8", 1/4", 8A	63.5	98.0
	1", 3/4", 5/8", 20A, 15A, 10A		80.0		105.0		
1 1/2"	1/2", 3/8", 1/4", 8A	38.1	73.0		1 1/4", 1", 3/4", 5/8", 25A, 20A, 15A, 10A		115.0
	1 1/4", 1", 3/4", 5/8", 25A, 20A, 15A, 10A		80.0		(125.0)		
2"	1/2", 3/8", 1/4", 8A	38.1	73.0	4"	2", 1 1/2", 50A, 40A, 32A	63.5	115.0
	1 1/4", 1", 3/4", 5/8", 25A, 20A, 15A, 10A		80.0		125.0		
	1 1/2", 40A, 32A		(90.0)				
2 1/2"	1/2", 3/8", 1/4", 8A	38.1	73.0		4"		3", 2 1/2", 80A, 65A
	1 1/4", 1", 3/4", 5/8", 25A, 20A, 15A, 10A		80.0	125.0			
	2", 1 1/2", 50A, 40A, 32A		(90.0)				

Reducing Tee

RTB

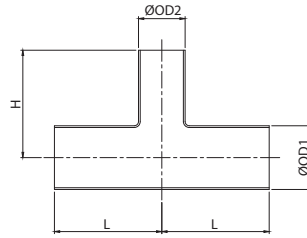
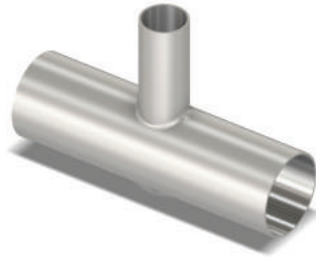

(Unit = mm)

Pipe Size (A Size)							
O.D1	O.D2	L	H	O.D1	O.D2	L	H
8A	1/2", 3/8", 1/4"	42.0	42.0	125A	8A, 1/2", 3/8", 1/4"	80.0	110.0
10A	8A, 1/2", 3/8", 1/4"	47.0	44.0		25A, 20A, 15A, 10A, 1 1/4", 1", 3/4", 5/8"	100.0	120.0
15A	8A, 1/2", 3/8", 1/4"	47.0	44.0		50A, 40A, 32A, 2", 1 1/2"	120.0	130.0
	10A, 3/4", 5/8"	52.0	52.0		100A, 80A, 65A, 4", 3", 2 1/2"	140.0	140.0
20A	8A, 1/2", 3/8", 1/4"	47.0	47.0	5"	160.0	160.0	
	15A, 10A, 1", 3/4", 5/8"	55.0	55.0	8A, 1/2", 3/8", 1/4"	90.0	130.0	
25A	8A, 1/2", 3/8", 1/4"	47.0	50.0	25A, 20A, 15A, 10A, 1 1/4", 1", 3/4", 5/8"	110.0	140.0	
	20A, 15A, 10A, 1 1/4", 1", 3/4", 5/8"	59.0	59.0	50A, 40A, 32A, 2", 1 1/2"	130.0	150.0	
32A	8A, 1/2", 3/8", 1/4"	57.0	54.0	100A, 80A, 65A, 4", 3", 2 1/2"	150.0	160.0	
	25A, 20A, 15A, 10A, 1 1/4", 1", 3/4", 5/8"	68.0	62.0	142.9, 136.5, 5"	170.0	170.0	
40A	8A, 1/2", 3/8", 1/4"	57.0	57.0	8A, 1/2", 3/8", 1/4"	100.0	150.0	
	25A, 20A, 15A, 10A, 1 1/4", 1", 3/4", 5/8"	68.0	65.0	25A, 20A, 15A, 10A, 1 1/4", 1", 3/4", 5/8"	120.0	160.0	
50A	32A, 1 1/2"	77.0	77.0	50A, 40A, 32A, 2", 1 1/2"	140.0	170.0	
	8A, 1/2", 3/8", 1/4"	57.0	63.0	100A, 80A, 65A, 4", 3", 2 1/2"	160.0	180.0	
65A	25A, 20A, 15A, 10A, 1 1/4", 1", 3/4", 5/8"	68.0	71.0	177.8, 168.3, 177.8, 161.9, 6", 5"	180.0	190.0	
	40A, 32A, 2", 1 1/2"	83.0	83.0	8A, 1/2", 3/8", 1/4"	110.0	180.0	
80A	8A, 1/2", 3/8", 1/4"	61.0	71.0	25A, 20A, 15A, 10A, 1", 3/4"	130.0	190.0	
	25A, 20A, 15A, 10A, 1 1/4", 1", 3/4", 5/8"	72.0	79.0	50A, 40A, 32A	150.0	200.0	
	50A, 40A, 32A, 2", 1 1/2"	88.0	90.0	100A, 80A, 65A	170.0	210.0	
100A	2 1/2"	97.0	97.0	215.9, 193.7, 215.9, 190.5	190.0	220.0	
	8A, 1/2", 3/8", 1/4"	61.0	77.0	215.9, 203.2	210.0	240.0	
	25A, 20A, 15A, 10A, 1 1/4", 1", 3/4", 5/8"	72.0	85.0	8A, 1/2", 3/8", 1/4"	120.0	200.0	
	50A, 40A, 32A, 2", 1 1/2"	88.0	96.0	25A, 20A, 15A, 10A, 1", 3/4"	140.0	210.0	
125A	65A, 3", 2 1/2"	103.0	103.0	50A, 40A, 32A	160.0	220.0	
	8A, 1/2", 3/8", 1/4"	61.0	90.0	100A, 80A, 65A	180.0	230.0	
	25A, 20A, 15A, 10A, 1 1/4", 1", 3/4", 5/8"	72.0	98.0	254.0, 219.1, 254.0, 215.9	200.0	240.0	
	50A, 40A, 32A, 2", 1 1/2"	88.0	109.0	254.0, 228.6	220.0	260.0	
150A	80A, 65A, 4", 3", 2 1/2"	116.0	116.0				

*125A(100A, 80A, 65A, 50A) / 150A(125A, 100A, 80A, [65A]) / 200A(150A, 125A, 100A) Bevel end at large dia. Side.

Tube Size (Inch Size)							
O.D1	O.D2	L	H	O.D1	O.D2	L	H
3/8"	1/4"	37.0	37.0	3"	1/2", 3/8", 1/4", 8A	61.0	71.0
1/2"	3/8", 1/4"	39.0	39.0		1 1/4", 1", 3/4", 5/8", 25A, 20A, 15A, 10A	72.0	79.0
5/8"	1/2", 3/8", 1/4", 8A	47.0	44.0		2", 1 1/2", 50A, 40A, 32A	90.0	90.0
3/4"	1/2", 3/8", 1/4", 8A	47.0	44.0	2 1/2", 65A	97.0	97.0	
	5/8", 10A	52.0	52.0	1/2", 3/8", 1/4", 8A	61.0	87.0	
1"	1/2", 3/8", 1/4", 8A	47.0	47.0	1 1/4", 1", 3/4", 5/8", 25A, 20A, 15A, 10A	72.0	95.0	
	3/4", 5/8", 15A, 10A	55.0	55.0	2", 1 1/2", 50A, 40A, 32A	90.0	105.0	
1 1/4"	1/2", 3/8", 1/4", 8A	47.0	50.0	3", 2 1/2", 80A, 65A	110.0	110.0	
	1", 3/4", 5/8", 20A, 15A, 10A	59.0	59.0	1/2", 3/8", 1/4", 8A	70.0	100.0	
1 1/2"	1/2", 3/8", 1/4", 8A	57.0	54.0	1 1/4", 1", 3/4", 5/8", 25A, 20A, 15A, 10A	90.0	110.0	
	1 1/4", 1", 3/4", 5/8", 25A, 20A, 15A, 10A	68.0	62.0	2", 1 1/2", 50A, 40A, 32A	110.0	120.0	
2"	1/2", 3/8", 1/4", 8A	57.0	57.0	4", 3", 2 1/2", 100A, 80A, 65A	140.0	140.0	
	1 1/4", 1", 3/4", 5/8", 25A, 20A, 15A, 10A	68.0	65.0	1/2", 3/8", 1/4", 8A	80.0	115.0	
2 1/2"	1 1/2", 40A, 32A	77.0	77.0	1 1/4", 1", 3/4", 5/8", 25A, 20A, 15A, 10A	100.0	125.0	
	1/2", 3/8", 1/4", 8A	61.0	63.0	2", 1 1/2", 50A, 40A, 32A	120.0	135.0	
	1 1/4", 1", 3/4", 5/8", 25A, 20A, 15A, 10A	72.0	71.0	4", 3", 2 1/2", 100A, 80A, 65A	140.0	145.0	
	2", 1 1/2", 50A, 40A, 32A	90.0	83.0	5", 125A	160.0	160.0	

Joint Tee(Male / Female)

JTM / JTF

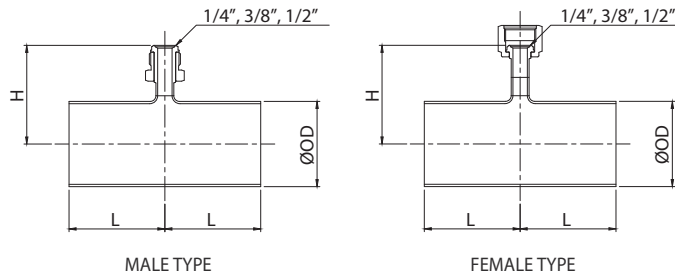

(Unit = mm)

		Pipe Size (A Size)													
O.D		8A	10A	15A	20A	25A	32A	40A	50A	65A	80A	100A	125A	150A	200A
L		45.0	52.0	52.0	55.0	59.0	68.0	68.0	68.0	72.0	72.0	72.0	100.0	110.0	120.0
Female	H	35.0	37.0	39.5	42.5	46.5	51.0	54.0	60.0	68.0	74.5	87.0	100.0	113.0	138.5
Male	H	45.0	47.0	49.5	52.5	56.5	61.0	64.0	70.0	78.0	84.5	97.0	110.0	123.0	148.5

		Tube Size (Inch Size)													
O.D		1/4"	3/8"	1/2"	5/8"	3/4"	1"	1 1/4"	1 1/2"	2"	2 1/2"	3"	4"	5"	6"
L		43.0	45.0	45.0	52.0	52.0	55.0	59.0	68.0	68.0	72.0	72.0	72.0	90.0	100.0
Female	H	31.5	33.5	35.0	36.5	38.0	42.0	45.5	48.0	55.0	61.5	68.0	81.0	94.0	107.0
Male	H	41.5	43.5	45.0	46.5	48.0	52.0	55.5	58.0	65.0	72.5	78.0	91.0	104.0	117.0

Joint Cap(Male / Female)

JCM / JCF

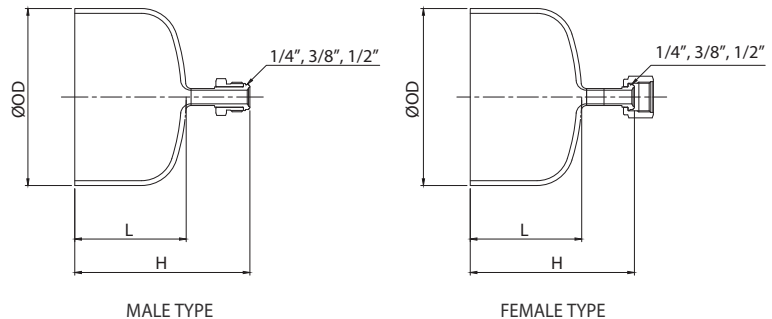

(Unit = mm)

		Pipe Size (A Size)												
O.D		10A	15A	20A	25A	32A	40A	50A	65A	80A	100A	125A	150A	200A
Cap Length	L	19.1	25.4	25.4	38.1	38.1	38.1	38.1	38.1	50.8	63.5	76.2	88.9	101.6
Female	H	48.0	55.0	55.0	68.0	68.0	68.0	68.0	68.0	81.0	94.0	107.0	120.0	133.0
Male	H	58.0	65.0	65.0	78.0	78.0	78.0	78.0	78.0	91.0	104.0	117.0	130.0	143.0

		Tube Size (Inch Size)							
O.D		3/4"	1"	1 1/4"	1 1/2"	2"	2 1/2"	3"	4"
Cap Length	L	19.1	25.4	38.1	38.1	38.1	38.1	38.1	63.5
Female	H	48.0	55.0	68.0	68.0	68.0	68.0	68.0	94.0
Male	H	58.0	65.0	78.0	78.0	78.0	78.0	78.0	104.0

Multi-Header Tee

MHT

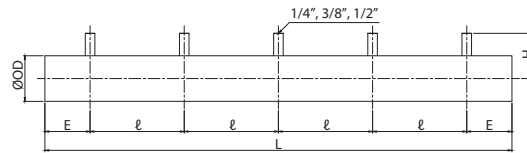

(Unit = mm)

Pipe Size (A Size)													
O.D		8A	10A	15A	20A	25A	32A	40A	50A	65A	80A	100A	
Length at End	E	60.0										70.0	
	ℓ	125.0										145.0	
Total Length (L)	Number of Branches	2	245.0										285.0
		3	370.0										430.0
		4	495.0										575.0
		5	620.0										720.0
Branch Tube Height	Tube-End(H)	42.0	44.0	44.0	47.0	50.0	54.0	57.0	63.0	71.0	77.0	90.0	
	Female(H)	35.0	37.0	39.5	42.5	46.5	51.0	54.0	60.0	68.0	74.5	87.0	

Tube Size (Inch Size)														
O.D		1/4"	3/8"	1/2"	5/8"	3/4"	1"	1 1/4"	1 1/2"	2"	2 1/2"	3"	4"	
Length at End	E	76.2												
	ℓ	152.4												
Total Length (L)	Number of Branches	2	304.8											
		3	457.2											
		4	609.6											
		5	762.0											
Branch Tube Height	Tube-End(H)	35.0	37.0	39.0	44.0	44.0	47.0	50.0	54.0	57.0	63.0	71.0	87.0	
	Female(H)	31.5	33.5	35.0	36.5	38.0	42.0	45.5	48.0	55.0	61.5	68.0	81.0	

Multi-Header Joint Tee

MJT

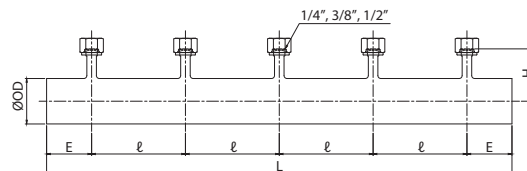

(Unit = mm)

Pipe Size (A Size)													
O.D		8A	10A	15A	20A	25A	32A	40A	50A	65A	80A	100A	
Length at End	E	23.0	29.0	31.0	34.0	42.0	46.0	49.0	60.0	68.0	74.5	87.0	
	ℓ	125.0										145.0	
Total Length (L)	Number of Branches	2	245.0										285.0
		3	370.0										430.0
		4	495.0										575.0
		5	620.0										720.0
Branch Tube Height	Tube-End(H)	42.0	44.0	44.0	47.0	50.0	54.0	57.0	63.0	71.0	77.0	90.0	
	Female(H)	35.0	37.0	39.5	42.5	46.5	51.0	54.0	60.0	68.0	74.5	87.0	

Tube Size (Inch Size)														
O.D		1/4"	3/8"	1/2"	5/8"	3/4"	1"	1 1/4"	1 1/2"	2"	2 1/2"	3"	4"	
Length at End	E	21.0	21.0	21.0	27.0	30.0	33.0	40.0	45.0	50.0	65.0	68.0	86.0	
	ℓ	154.4												
Total Length (L)	Number of Branches	2	304.8											
		3	457.2											
		4	609.6											
		5	762.0											
Branch Tube Height	Tube-End(H)	35.0	37.0	39.0	44.0	44.0	47.0	50.0	54.0	57.0	63.0	71.0	87.0	
	Female(H)	31.5	33.5	35.0	36.5	38.0	42.0	45.5	48.0	55.0	61.5	68.0	81.0	

Flange Connection

Lap Joint

LAJ

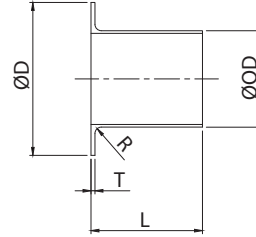

(Unit = mm)

Pipe Size (A Size)																
O.D	10A	15A	20A	25A	32A	40A	50A	65A	80A	100A	125A	150A	200A	250A	300A	
L	55.0	55.0	55.0	55.0	70.0	70.0	70.0	75.0	75.0	75.0	50.0	50.0	65.0	65.0	65.0	
D	JIS 10K	46.0	51.0	56.0	67.0	76.0	81.0	96.0	116.0	126.0	151.0	182.0	212.0	262.0	324.0	368.0
	JIS 5K	39.0	44.0	49.0	59.0	70.0	75.0	85.0	110.0	121.0	141.0	182.0	212.0	262.0	324.0	368.0
R	3.0	3.0	3.0	3.0	3.0	3.0	3.0	4.0	4.0	5.0	5.0	5.0	5.0	5.0	5.0	5.0
T	2.50	2.50	2.50	2.50	2.50	2.50	2.50	2.50	2.50	2.50	2.50	5.0	5.0	7.0	7.0	9.0
Tube Size (Inch Size)																
O.D	3/4"	1"	1 1/4"	1 1/2"	2"	2 1/2"	3"	4"	5"	6"						
L	55.0	55.0	55.0	70.0	70.0	70.0	75.0	75.0	85.0	90.0						
D	51.0	56.0	67.0	76.0	81.0	96.0	116.0	136.0	182.0	212.0						
R	3.0	3.0	3.0	3.0	3.0	4.0	4.0	5.0	5.0	5.0						
T	2.5	2.5	2.5	2.5	2.5	2.5	2.5	2.5	3.0	3.0						

Pipe Flange

PF

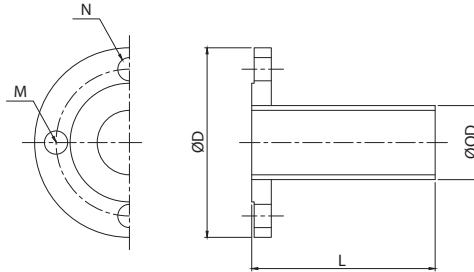
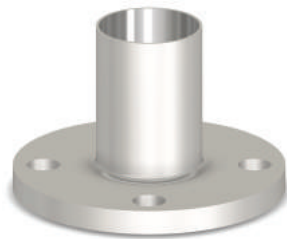

(Unit = mm)

Pipe Size (A Size)															
O.D	10A	15A	20A	25A	32A	40A	50A	65A	80A	100A	125A	150A	200A	250A	300A
L	100.0	100.0	100.0	100.0	100.0	100.0	100.0	100.0	100.0	100.0	200.0	200.0	200.0	200.0	200.0
D	90.0	95.0	100.0	125.0	135.0	140.0	155.0	175.0	185.0	210.0	250.0	280.0	330.0	400.0	445.0
N	4.0	4.0	4.0	4.0	4.0	4.0	4.0	4.0	8.0	8.0	8.0	8.0	12.0	12.0	16.0
M	M12	M12	M12	M16	M16	M16	M16	M16	M16	M16	M20	M20	M20	M22	M22
Tube Size (Inch Size)															
O.D	3/4"	1"	1 1/4"	1 1/2"	2"	2 1/2"	3"	4"	5"	6"					
L	100.0	100.0	100.0	100.0	100.0	100.0	100.0	100.0	200.0	200.0					
D	95.0	100.0	125.0	135.0	140.0	155.0	175.0	195.0	250.0	280.0					
N	4.0	4.0	4.0	4.0	4.0	4.0	4.0	8.0	8.0	8.0					
M	M12	M12	M16	M16	M16	M16	M16	M16	M20	M20					

JIS RF Flange / JIS Blind Flange

RFF / BLF

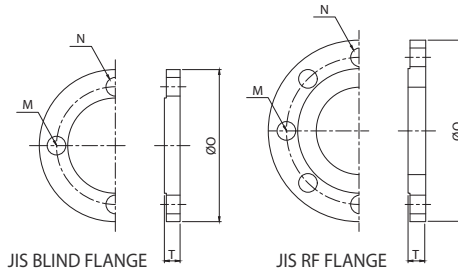

(Unit = mm)

Pipe Size (A Size)															
JIS 10K															
O.D	10A	15A	20A	25A	32A	40A	50A	65A	80A	100A	125A	150A	200A	250A	300A
D	90.0	95.0	100.0	125.0	135.0	140.0	155.0	175.0	185.0	210.0	250.0	280.0	330.0	400.0	445.0
T	12.0	12.0	14.0	14.0	16.0	16.0	16.0	18.0	18.0	18.0	20.0	22.0	22.0	24.0	24.0
N	4.0	4.0	4.0	4.0	4.0	4.0	4.0	4.0	8.0	8.0	8.0	8.0	12.0	12.0	16.0
M	M12	M12	M12	M16	M16	M16	M16	M16	M16	M16	M20	M20	M20	M22	M22
JIS 5K															
O.D	10A	15A	20A	25A	32A	40A	50A	65A	80A	100A	125A	150A	200A	250A	300A
D	75.0	80.0	85.0	95.0	115.0	120.0	130.0	155.0	180.0	200.0	235.0	265.0	320.0	385.0	430.0
T	9.0	9.0	10.0	10.0	12.0	12.0	14.0	14.0	14.0	16.0	16.0	18.0	20.0	22.0	22.0
N	4.0	4.0	4.0	4.0	4.0	4.0	4.0	4.0	4.0	8.0	8.0	8.0	8.0	12.0	12.0
M	M10	M10	M10	M10	M12	M12	M12	M12	M16	M16	M16	M16	M20	M20	M20
Tube Size (Inch Size)															
O.D	3/4"	1"	1 1/4"	1 1/2"	2"	2 1/2"	3"	4"	5"	6"					
FP / T	95.0	100.0	125.0	135.0	140.0	155.0	175.0	195.0	250.0	280.0					
D	12.0	14.0	14.0	16.0	16.0	16.0	18.0	18.0	20.0	22.0					
N	4.0	4.0	4.0	4.0	4.0	4.0	4.0	8.0	8.0	8.0					
M	M12	M12	M16	M16	M16	M16	M16	M16	M20	M20					

Teflon Gasket

TG

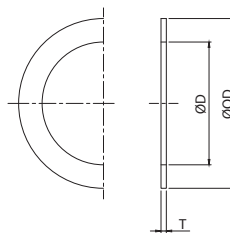

(Thickness T=2mm, Unit = mm)

Pipe Size (A Size)															
JIS 10K															
D	10A	15A	20A	25A	32A	40A	50A	65A	80A	100A	125A	150A	200A	250A	300A
O.D	53.0	58.0	63.0	74.0	84.0	89.0	104.0	124.0	134.0	159.0	190.0	220.0	270.0	333.0	378.0
I.D	18.0	22.0	28.0	35.0	43.0	49.0	61.0	77.0	90.0	115.0	141.0	167.0	218.0	270.0	321.0
JIS 5K															
D	10A	15A	20A	25A	32A	40A	50A	65A	80A	100A	125A	150A	200A	250A	300A
O.D	45.0	50.0	55.0	65.0	78.0	83.0	93.0	118.0	129.0	149.0	184.0	214.0	260.0	325.0	370.0
I.D	18.0	22.0	28.0	35.0	43.0	49.0	61.0	77.0	90.0	115.0	141.0	167.0	218.0	270.0	321.0
Tube Size (Inch Size)															
D	3/4"	1"	1 1/4"	1 1/2"	2"	2 1/2"	3"	4"	5"	6"					
O.D	58.0	63.0	74.0	84.0	89.0	104.0	124.0	144.0	190.0	220.0					
I.D	19.5	26.0	32.5	38.5	51.5	64.0	77.0	102.5	128.0	153.5					

Coaxial Fittings

Coaxial 90° Elbow

CLE

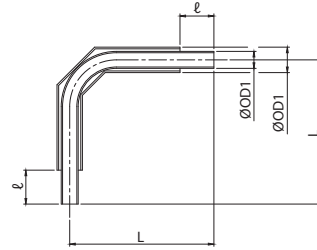

(Unit = mm)

Tube Size	Inner Tube $\Phi O.D1$	$\Phi O.D1$ Wall Thickness	Outer Tube $\Phi O.D2$	$\Phi O.D2$ Wall Thickness	ℓ	L
1/4"	1/4"	0.89t/1t	1/2"	1.24t	25.4	111.0
3/8"	3/8"	0.89t/1t	5/8"	1.24t	25.4	104.6
1/2"	1/2"	1.24t	3/4"	1.65t	25.4	108.0
3/4"	3/4"	1.65t	1"	1.65t	44.5	171.5
1"	1"	1.65t	1 1/4"	1.65t	44.5	180.8
1 1/2"	1 1/2"	1.65t	2"	1.65t	50.8	212.6

Coaxial 45° Elbow

CHE

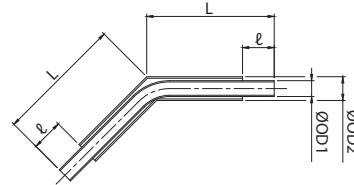

(Unit = mm)

Tube Size	Inner Tube $\Phi O.D1$	$\Phi O.D1$ Wall Thickness	Outer Tube $\Phi O.D2$	$\Phi O.D2$ Wall Thickness	ℓ	L
1/4"	1/4"	0.89t/1t	1/2"	1.24t	25.4	101.6
3/8"	3/8"	0.89t/1t	5/8"	1.24t	25.4	98.3
1/2"	1/2"	1.24t	3/4"	1.65t	25.4	98.3
3/4"	3/4"	1.65t	1"	1.65t	44.5	155.4
1"	1"	1.65t	1 1/4"	1.65t	44.5	158.8
1 1/2"	1 1/2"	1.65t	2"	1.65t	50.8	180.8

Coaxial Equal Tee

CET

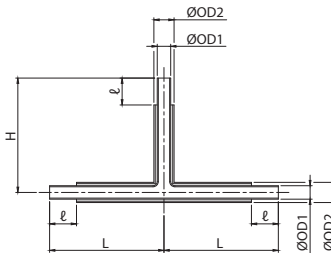
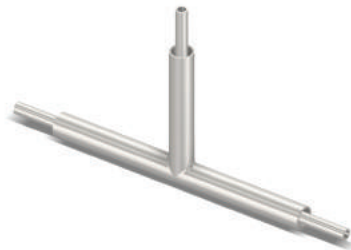

(Unit = mm)

Tube Size	Inner Tube $\Phi O.D1$	$\Phi O.D1$ Wall Thickness	Outer Tube $\Phi O.D2$	$\Phi O.D2$ Wall Thickness	ℓ	L	H
1/4"	1/4"	0.89t/1t	1/2"	1.24t	25.4	98.4	98.4
3/8"	3/8"	0.89t/1t	5/8"	1.24t	25.4	101.6	101.6
1/2"	1/2"	1.24t	3/4"	1.65t	25.4	101.6	101.6
3/4"	3/4"	1.65t	1"	1.65t	44.5	161.9	161.9
1"	1"	1.65t	1 1/4"	1.65t	44.5	165.1	165.1
1 1/2"	1 1/2"	1.65t	2"	1.65t	50.8	193.7	193.7

Coaxial Reducing Tee

CRT

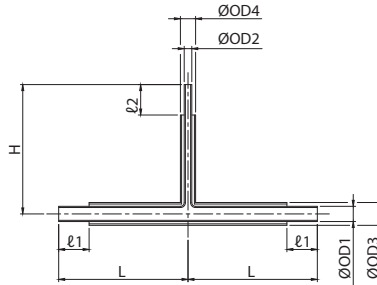

(Unit = mm)

Tube Size	Inner Tube ØO.D1	ØO.D1 Wall Thickness	Inner Tube ØO.D2	ØO.D2 Wall Thickness	Outer Tube ØO.D3	ØO.D3 Wall Thickness	Outer Tube ØO.D4	ØO.D4 Wall Thickness	ℓ1	L	ℓ2	H
3/8"x1/4"	3/8"	0.89/1t	1/4"	0.89/1t	5/8"	1.24t	1/2"	1.24t	25.4	98.4	25.4	104.6
1/2"x1/4"	1/2"	1.24t	1/4"	0.89/1t	3/4"	1.65t	1/2"	1.24t	25.4	98.4	25.4	104.6
1/2"x3/8"	1/2"	1.65t	3/8"	0.89/1t	3/4"	1.65t	5/8"	1.24t	25.4	101.6	25.4	104.6
3/4"x1/4"	3/4"	1.65t	1/4"	0.89/1t	1"	1.65t	1/2"	1.24t	44.5	155.6	25.4	108.0
3/4"x3/8"	3/4"	1.65t	3/8"	0.89/1t	1"	1.65t	5/8"	1.24t	44.5	158.8	25.4	108.0
3/4"x1/2"	3/4"	1.65t	1/2"	1.24t	1"	1.65t	3/4"	1.65t	44.5	158.8	25.4	108.0
1"x1/4"	1"	1.65t	1/4"	0.89/1t	1 1/4"	1.65t	1/2"	1.24t	44.5	155.6	25.4	111.0
1"x3/8"	1"	1.65t	3/8"	0.89/1t	1 1/4"	1.65t	5/8"	1.24t	44.5	158.8	25.4	111.0
1"x1/2"	1"	1.65t	1/2"	1.24t	1 1/4"	1.65t	3/4"	1.65t	44.5	158.8	25.4	111.0
1"x3/4"	1"	1.65t	3/4"	1.65t	1 1/4"	1.65t	1"	1.65t	44.5	161.9	44.5	168.2
1 1/2"x3/4"	1 1/2"	1.65t	3/4"	1.65t	2"	1.65t	1"	1.65t	50.8	181.0	44.5	177.8
1 1/2"x1"	1 1/2"	1.65t	1"	1.65t	2"	1.65t	1 1/4"	1.65t	50.8	184.2	44.5	177.8

Coaxial Sleeve

CSL

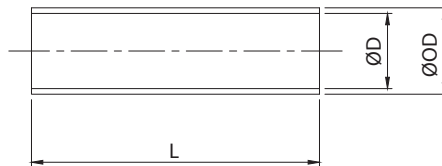

(Unit = mm)

Tube Size	O.D	I.D	L	L(E4*)	L(E5*)	L(E6*)
1/4"	5/8"	Ø12.8 / Ø12.9	63.5	101.6	127.0	152.4
3/8"	3/4"	Ø16.0 / Ø16.1	63.5	101.6	127.0	152.4
1/2"	7/8"	Ø19.2 / Ø19.3	63.5	101.6	127.0	152.4
3/4"	1 1/8"	Ø25.5 / Ø25.6	101.6	-	127.0	152.4
1"	1 3/8"	Ø31.9 / Ø32.0	101.6	-	-	-
1 1/2"	2 1/8"	Ø51.3 / Ø51.4	114.3	-	-	-

Coaxial Reducer

CRC

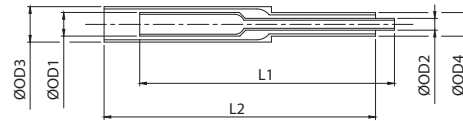

(Unit = mm)

Tube Size	Inner Tube ØO.D1	ØO.D1 Wall Thickness	Inner Tube ØO.D2	ØO.D2 Wall Thickness	Outer Tube ØO.D3	ØO.D3 Wall Thickness	Outer Tube ØO.D4	ØO.D4 Wall Thickness	L1	L2
3/8"x1/4"	3/8"	0.89/1t	1/4"	0.89/1t	5/8"	1.24t	1/2"	1.24t	101.6	101.6
1/2"x1/4"	1/2"	1.24t	1/4"	0.89/1t	3/4"	1.65t	1/2"	1.24t	101.6	101.6
1/2"x3/8"	1/2"	1.24t	3/8"	0.89/1t	3/4"	1.65t	5/8"	1.24t	101.6	101.6
3/4"x1/4"	3/4"	1.65t	1/4"	0.89/1t	1"	1.65t	1/2"	1.24t	127.0	146.0
3/4"x3/8"	3/4"	1.65t	3/8"	0.89/1t	1"	1.65t	5/8"	1.24t	127.0	146.0
3/4"x1/2"	3/4"	1.65t	1/2"	1.24t	1"	1.65t	3/4"	1.65t	127.0	146.0
1"x1/4"	1"	1.65t	1/4"	0.89/1t	1 1/4"	1.65t	1/2"	1.24t	127.0	146.0
1"x3/8"	1"	1.65t	3/8"	0.89/1t	1 1/4"	1.65t	5/8"	1.24t	127.0	146.0
1"x1/2"	1"	1.65t	1/2"	1.24t	1 1/4"	1.65t	3/4"	1.65t	127.0	146.0
1"x3/4"	1"	1.65t	3/4"	1.65t	1 1/4"	1.65t	1"	1.65t	165.1	165.1
1 1/2"x1/4"	1 1/2"	1.65t	1/4"	0.89/1t	2"	1.65t	1/2"	1.24t	146.0	171.5
1 1/2"x3/8"	1 1/2"	1.65t	3/8"	0.89/1t	2"	1.65t	5/8"	1.24t	146.0	171.5
1 1/2"x1/2"	1 1/2"	1.65t	1/2"	1.24t	2"	1.65t	3/4"	1.65t	146.0	171.5
1 1/2"x3/4"	1 1/2"	1.65t	3/4"	1.65t	2"	1.65t	1"	1.65t	184.2	190.5
1 1/2"x1"	1 1/2"	1.65t	1"	1.65t	2"	1.65t	1 1/4"	1.65t	184.2	190.5

Coaxial Terminator

CTR

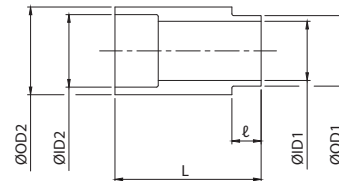

(Unit = mm)

Tube Size	ØO.D1	ØI.D1	ØO.D2	ØI.D2	ℓ	L
1/4"	Ø8.3	1/4"	1/2"	Ø10.2	6.35	31.8
3/8"	Ø11.4	3/8"	5/8"	Ø13.4	6.35	31.8
1/2"	Ø15.3	1/2"	3/4"	Ø15.7	6.35	31.8
3/4"	Ø22.5	3/4"	1"	Ø22.1	6.35	50.8
1"	Ø28.8	1"	1 1/4"	Ø28.4	6.35	50.8
1 1/2"	Ø41.5	1 1/2"	2"	Ø47.4	6.35	57.2



Safe Component Selection

The selection of component for any applications or system design must be considered to ensure safe performance. Component function, material compatibility, component ratings, proper installation, operation and maintenance remain the sole responsibility of the system designer and the user. DK-Lok accepts no liability for any improper selection, installation, operation or maintenance.