

## Female Nut Blind Nut

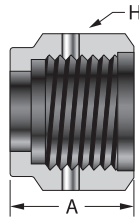

## Blind Nut

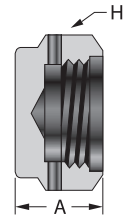

Part No.	DO Size	Dimensions, in. (mm)	
		A	H
DON-4	1/8 and 1/4	0.66 (16.8)	11/16
DON-8	3/8 and 1/2	0.69 (17.5)	1
DON-12	3/4	0.81 (20.6)	1 1/2
DON-16	1	0.81 (20.6)	1 3/4

Part No.	DO Size	Dimensions, in. (mm)	
		A	H
DONB-4	1/8 and 1/4	0.44 (11.2)	11/16
DONB-8	3/8 and 1/2	0.56 (14.2)	1
DONB-12	3/4	0.75 (19.1)	1 1/2
DONB-16	1	0.81 (20.6)	1 3/4

## Glands Swivel Union

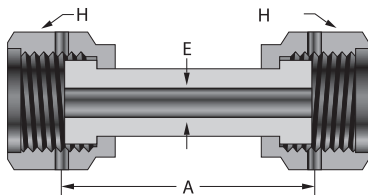

Part No.	DO Size	Dimensions, in. (mm)			Pressure Rating Psig (bar)
		A	E	H	
DOGU-4	1/4	1.42 (36.1)	0.18 (4.6)	11/16	10 200 (702)
DOGU-8	1/2	1.61 (40.9)	0.40 (10.2)	1	5 800 (399)

## Dk-Lok Tube Fitting Connector

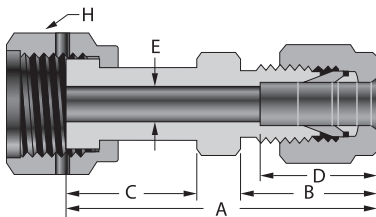

Part No.	DO Size	Tube OD	Dimensions, in. (mm)					Pressure Rating Psig (bar)	
			A	B	C	D	E		
DOGDC 4-4T	1/4	1/4	1.74 (44.2)	0.70 (17.8)	0.77 (19.6)	0.60 (15.2)	0.18 (4.6)	11/16	10 200 (702)
DOGDC 8-6T	1/2	3/8	1.87 (47.5)	0.76 (19.3)	0.81 (20.6)	0.66 (16.8)	0.28 (7.1)	1	5 800 (399)
DOGDC 8-8T	1/2	1/2	2.01 (51.1)	0.87 (22.1)		0.40 (10.2)	0.40 (10.2)		
DOGDC 12-12T	3/4	3/4	2.14 (54.4)	0.87 (22.1)	0.94 (23.9)	0.96 (24.4)	0.62 (15.7)	1 1/2	4 000 (275)
DOGDC 16-16T	1	1	2.45 (62.2)	1.04 (26.4)	0.98 (24.9)	1.23 (31.2)	0.87 (22.1)	1 3/4	3 000 (206)

## Tube Adapter Gland

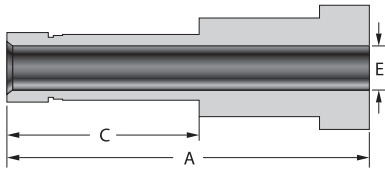

Part No	DO Size	Tube OD	Dimensions, in. (mm)			Pressure Rating Psig (bar)
			A	C	E	
DOGTA 4-4T	1/4	1/4	1.31 (33.3)	0.64 (16.3)	0.18 (4.6)	10 200 (702)
DOGTA 8-6T	1/2	3/8	1.38 (35.1)	0.70 (17.8)	0.27 (6.8)	6 500 (447)
DOGTA 8-8T	1/2	1/2	1.62 (41.1)	0.96 (24.4)	0.37 (9.3)	6 700 (461)
DOGTA 12-12T	3/4	3/4	1.80 (45.7)	1.02 (25.9)	0.58 (14.7)	5 800 (399)
DOGTA 16-16T	1	1	2.05 (52.1)	1.30 (33.0)	0.80 (20.3)	4 700 (323)

## Weld Tube Socket Weld Gland

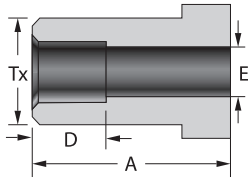

Part No	DO Size	Tube OD	Dimensions, in. (mm)				Pressure Rating Psig (bar)
			A	D	E	Tx	
DOGTSW 2-2T	1/8	1/8	0.77 (19.6)	0.10 (2.5)	0.09 (2.3)	0.38 (9.7)	15 400 (1061)
DOGTSW 4-4T	1/4	1/4	0.77 (19.6)	0.28 (7.1)	0.18 (4.6)	0.38 (9.7)	6 800 (468)
DOGTSW 6-6T	3/8	3/8	0.81 (20.6)	0.31 (7.9)	0.28 (7.1)	0.60 (15.2)	8 100 (558)
DOGTSW 8-8T	1/2	1/2	0.81 (20.6)	0.38 (9.7)	0.40 (10.2)	0.60 (15.2)	3 000 (206)
DOGTSW 12-12T	3/4	3/4	0.94 (23.9)	0.44 (11.2)	0.62 (15.7)	0.92 (23.4)	3 700 (255)
DOGTSW 16-16T	1	1	0.98 (24.9)	0.62 (15.7)	0.87 (22.1)	1.19 (30.2)	3 000 (206)

## Tube Socket Weld Reducing Gland

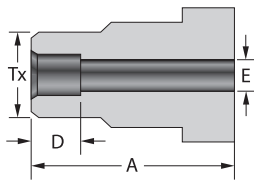

Part No	DO Size	Tube OD	Dimensions, in. (mm)				Pressure Rating Psig (bar)
			A	D	E	Tx	
DOGRTSW 4-2T	1/4	1/8	0.77 (19.6)	0.10 (2.5)	0.09 (2.3)	0.29 (7.4)	12 600 (868)
DOGRTSW 8-4T	1/2	1/4	0.81 (20.6)	0.28 (7.1)	0.18 (4.6)	0.48 (12.2)	10 700 (737)

## Male Tube Weld Gland

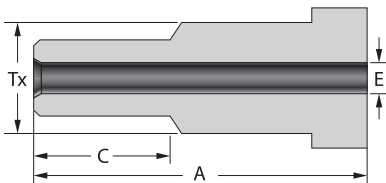

Part No	DO Size	Tube OD	Dimensions, in. (mm)				Pressure Rating Psig (bar)
			A	D	E	Tx	
DOGMTW 4-2T	1/4	1/8	0.77 (19.6)	0.10 (2.5)	0.09 (2.3)	0.38 (9.7)	15 400 (1061)
DOGMTW 4-4T		1/4	0.77 (19.6)	0.28 (7.1)	0.18 (4.6)	0.38 (9.7)	6 800 (468)
DOGMTW 8-4T	1/2	1/4	0.81 (20.6)	0.31 (7.9)	0.28 (7.1)	0.60 (15.2)	8 100 (558)
DOGMTW 8-6T		3/8	0.81 (20.6)	0.38 (9.7)	0.40 (10.2)	0.60 (15.2)	3 000 (206)
DOGMTW 8-8T		1/2	0.98 (24.9)	0.62 (15.7)	0.87 (22.1)	1.19 (30.2)	3 000 (206)

## Automatic Tube Weld Gland

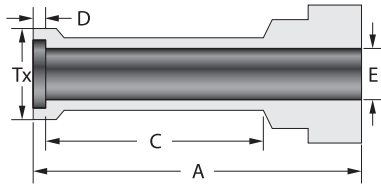

Part No	DO Size	Tube OD	Dimensions, in. (mm)						Pressure Rating Psig (bar)
			A	C	D	E	Tx	Wall Thickness	
DOGATW 4-4T	1/4	1/4	1.12 (28.4)	0.78 (19.8)	0.02 (0.51)	0.18 (4.6)	0.29 (7.4)	0.035	5 100 (351)
DOGATW 8-6T	1/2	3/8	1.13 (28.7)	0.79 (20.0)	0.03 (0.76)	0.31 (7.9)	0.41 (10.4)	0.035	3 300 (227)
DOGATW 8-8T	1/2	1/2	1.14 (29.0)	0.80 (20.3)	0.04 (1.0)	0.40 (10.2)	0.55 (14.0)	0.049	3 500 (241)
DOGATW 12-12T	3/4	3/4	1.20 (30.5)	0.80 (20.3)	0.04 (1.0)	0.65 (16.5)	0.80 (20.3)	0.049	2 200 (151)
DOGATW 16-16T	1	1	1.41 (35.8)	1.00 (25.4)	0.04 (1.0)	0.87 (22.1)	1.06 (26.9)	0.065	2 200 (151)

## Glands Male Connector

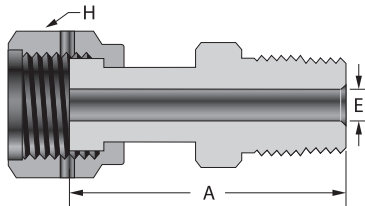

Part No	DO Size	Tube OD	Dimensions, in. (mm)			Pressure Rating Psig (bar)
			A	E	H	
DOGWMC 4-4N	1/4	1/4	1.59 (40.4)	0.18 (4.6)	11/16	9 800 (675)
DOGWMC 8-6N	1/2	3/8	1.67 (42.4)	0.40 (10.2)	1	5 600 (385)
DOGWMC 8-8N	1/2	1/2	1.87 (47.5)	0.40 (10.2)	1	5 600 (385)
DOGWMC 12-12N	3/4	3/4	2.03 (51.6)	0.62 (15.7)	1 1/2	3 900 (268)
DOGWMC 16-16N	1	1	2.36 (59.9)	0.87 (22.1)	1 3/4	2 900 (199)

## Female Connector

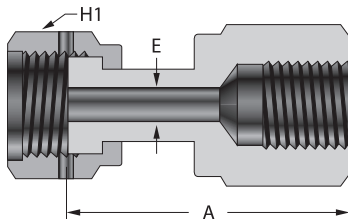

Part No	DO Size	NPT Size	Dimensions, in. (mm)				Pressure Rating Psig (bar)
			A	E	H	H1	
DOGF 4-4N	1/4	1/4	1.57 (39.9)	0.18 (4.6)	3/4	11/16	6 600 (454)
DOGF 8-6N	1/2	3/8	1.73 (43.9)	0.40 (10.2)	7/8	1	5 300 (365)
DOGF 8-8N	1/2	1/2	1.96 (49.8)	0.40 (10.2)	1 1/16	1	4 900 (337)
DOGF 12-12N	3/4	3/4	2.12 (53.8)	0.62 (15.7)	1 5/16	1 1/2	4 000 (275)
DOGF 16-16N	1	1	2.29 (58.2)	0.87 (22.1)	1 5/8	1 3/4	3 000 (206)

# IDK-LOK® DO Series O-Ring Face Seal Fittings

## Male SAE/MS Connector

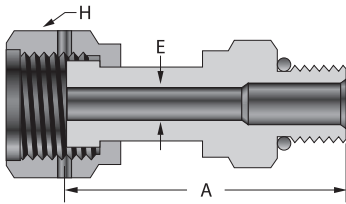

Part No	DO Size	Thread Size	Dimensions, in. (mm)			Pressure Rating Psig (bar)
			A	E	H	
DOGMCS 4-4U	1/4	7/16-20	1.54 (39.1)	0.18 (4.6)	11/16	4 500 (310)
DOGMCS 8-6U	1/2	9/16-18	1.64 (41.7)	0.40 (10.2)	1	4 500 (310)
DOGMCS 8-8U	1/2	3/4-16	1.71 (43.4)	0.40 (10.2)	1	4 500 (310)
DOGMCS 12-12U	3/4	1 1/16-12	2.07 (52.6)	0.62 (15.7)	1 1/2	3 600 (248)
DOGMCS 16-16U	1	1 5/16-12	2.17 (55.1)	0.87 (22.1)	1 3/4	2 900 (199)

## Bodies Union

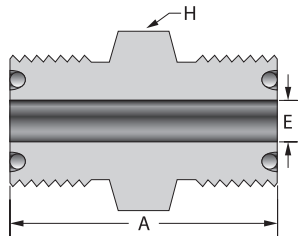

Part No	DO Size	Dimensions, in. (mm)			Pressure Rating Psig (bar)
		A	E	H	
DOBU-4	1/4	1.25 (31.8)	0.18 (4.6)	5/8	14 300 (985)
DOBU-8	1/2	1.50 (38.1)	0.40 (10.2)	15/16	11 100 (764)

## Bulkhead Union

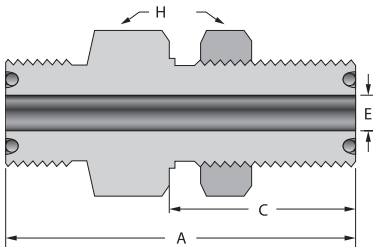

Part No	DO Size	Dimensions, in. (mm)						Pressure Rating Psig (bar)
		A	C	E	H	Panel Hole Drill Size	Wall Thickness	
DOBUB-4	1/4	1.88 (47.8)	1.06 (26.9)	0.18 (4.6)	3/4	37/64	0.36 (9.1)	14 300 (985)
DOBUB-8	1/2	2.09 (53.1)	1.19 (30.2)	0.40 (10.2)	1 1/16	57/64	0.40 (10.2)	11 100 (764)

## Reducing Union

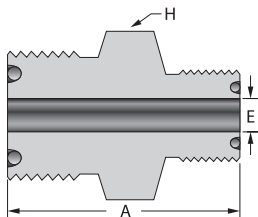

Part No	DO Size	DO Size	Dimensions, in. (mm)			Pressure Rating Psig (bar)
			A	E	H	
DOBUR 8-4	1/2	1/4	1.43 (36.3)	0.18 (4.6)	15/16	11 100 (764)

# IDK-LOK® DO Series O-Ring Face Seal Fittings

## Elbow

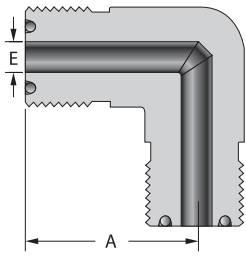

Part No	DO Size	Dimensions, in. (mm)		Pressure Rating Psig (bar)
		A	E	
DOBL-4	1/4	0.96 (24.4)	0.18 (4.6)	14 300 (985)
DOBL-8	1/2	1.26 (32.0)	0.40 (10.2)	11 100
DOBL-12	3/4	1.48 (37.6)	0.62 (15.7)	10 900 (751)
DOBL-16	1	1.56 (39.6)	0.87 (22.1)	8 800 (606)

## Tee

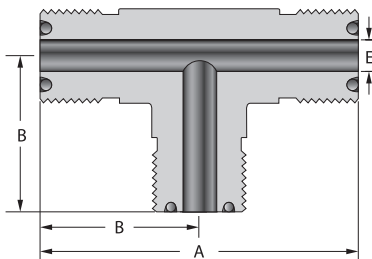

Part No	DO Size	Dimensions, in. (mm)			Pressure Rating Psig (bar)
		A	B	E	
DOBT-4	1/4	1.92 (48.8)	0.96 (24.4)	0.18 (4.6)	14 300 (985)
DOBT-8	1/2	2.52 (64.0)	1.26 (32.0)	0.40 (10.2)	11 100 (764)
DOBT-12	3/4	2.96 (75.2)	1.48 (37.6)	0.62 (15.7)	10 900 (751)
DOBT-16	1	3.12 (79.2)	1.56 (39.6)	0.87 (22.1)	8 800 (606)

## Bodies Plugs

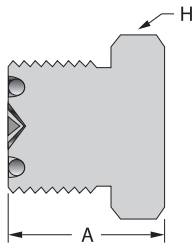

Part No	DO Size	Dimensions, in. (mm)	
		A	H
DOBB-4	1/4	0.77 (19.6)	5/8
DOBB-8	1/2	0.89 (22.6)	15/16
DOBB-12	3/4	0.99 (25.1)	1 5/16
DOBB-16	1	1.02 (25.9)	1 5/8

## Dk-Lok Tube Fitting Connector

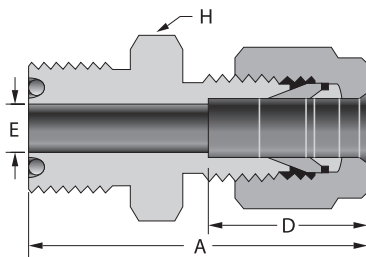

Part No	DO Size	Tube OD	Dimensions, in. (mm)				Pressure Rating Psig (bar)
			A	D	E	H	
DOBDMC 4-2T	1/4	1/8	1.38 (35.1)	0.51 (13.0)	0.09 (2.3)	5/8	10 900 (751)
DOBDMC 4-4T	1/4	1/4	1.47 (37.3)	0.60 (15.2)	0.18 (4.6)	5/8	10 200 (702)
DOBDMC 8-6T	1/2	3/8	1.65 (41.9)	0.66 (16.8)	0.28 (7.1)	15/16	6 500 (447)
DOBDMC 8-8T	1/2	1/2	1.78 (45.2)	0.90 (22.9)	0.40 (10.2)	15/16	6 700 (461)
DOBDMC 12-12T	3/4	3/4	1.86 (47.2)	0.96 (24.4)	0.62 (15.7)	1 5/16	5 800 (399)
DOBDMC 16-16T	1	1	2.06 (52.3)	1.23 (31.2)	0.87 (22.1)	1 5/8	4 700 (323)

# IDK-LOK® DO Series O-Ring Face Seal Fittings

## Dk-Lok Tube Fitting Bulkhead Connector

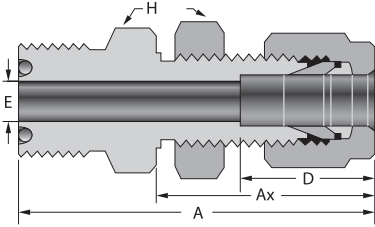

Part No	DO Size	Tube OD	Dimensions, in. (mm)					Pane Hole Drill Size	Max Panel Thickness	Pressure Rating Psig (bar)
			A	Ax	D	E	H			
DOBDFC 4-4T	1/4	1/4	2.10 (53.3)	1.32 (33.5)	0.60 (15.2)	0.18 (4.6)	5/8	29/64	0.40 (10.2)	10 200 (702)
DOBDFC 8-6T	1/2	3/8	2.34 (59.4)	1.45 (36.8)	0.66 (16.8)	0.28 (7.1)	15/16	37/64	0.44 (11.2)	6 500 (447)
DOBDFC 8-8T	1/2	1/2	2.55 (64.8)	1.65 (41.9)	0.90 (22.9)	0.40 (10.2)	15/16	49/64	0.50 (12.7)	6 700 (461)
DOBDFC 12-12T	3/4	3/4	2.86 (72.6)	1.87 (47.5)	0.96 (24.4)	0.62 (15.7)	1 5/16	1 1/64	0.66 (16.8)	5 800 (399)
DOBDFC 16-16T	1	1	3.29 (83.6)	2.26 (57.4)	1.23 (31.2)	0.87 (22.1)	1 5/8	1 21/64	0.75 (19.1)	4 700 (323)

## Dk-Lok Tube Fitting Elbow

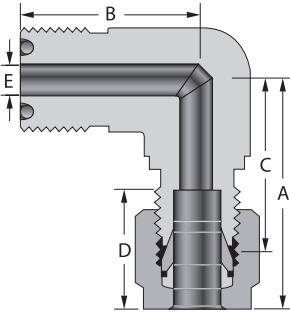

Part No	DO Size	Tube OD	Dimensions, in. (mm)					Pressure Rating Psig (bar)
			A	B	C	D	E	
DOBLD 4-4T	1/4	1/4	1.19 (30.2)	0.96 (24.4)	0.90 (22.9)	0.60 (15.2)	0.18 (4.6)	10 200 (702)
DOBLD 8-6T	1/2	3/8	1.39 (35.3)	1.26 (32.0)	1.10 (27.9)	0.66 (16.8)	0.28 (7.1)	6 500 (447)
DOBLD 8-8T	1/2	1/2	1.50 (38.1)	1.26 (32.0)	1.10 (27.9)	0.90 (22.9)	0.40 (10.2)	6 700 (461)
DOBLD 12-12T	3/4	3/4	1.80 (45.7)	1.48 (37.6)	1.40 (35.6)	0.96 (24.4)	0.62 (15.7)	5 800 (399)
DOBLD 16-16T	1	1	2.04 (51.8)	1.56 (39.6)	1.56 (31.2)	1.23 (31.2)	0.87 (22.1)	4 700 (323)

## Bodies Tube Socket Weld Connector

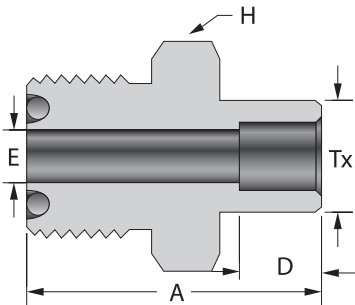

Part No	DO Size	Tube OD	Dimensions, in. (mm)					Pressure Rating Psig (bar)
			A	D	E	H	Tx	
DOBCSW 2-2T	1/8	1/8	0.88 (22.4)	0.10 (2.5)	0.09 (2.3)	5/8	0.29 (7.4)	12 600 (868)
DOBCSW 4-4T	1/4	1/4	1.09 (27.7)	0.28 (7.1)	0.18 (4.6)	5/8	0.38 (9.7)	6 800 (468)
DOBCSW 6-6T	3/8	3/8	1.28 (32.5)	0.31 (7.9)	0.28 (7.1)	15/16	0.60 (15.2)	8 100 (558)
DOBCSW 8-8T	1/2	1/2	1.34 (34.0)	0.38 (9.7)	0.40 (10.2)	15/16	0.60 (15.2)	3 000 (206)
DOBCSW 12-12T	3/4	3/4	1.50 (38.1)	0.44 (11.2)	0.62 (15.7)	1 5/16	0.92 (23.4)	3 700 (255)
DOBCSW 16-16T	1	1	1.72 (43.7)	0.62 (15.7)	0.87 (22.1)	1 5/8	1.19 (30.2)	3 000 (206)

## Automatic Tube Weld Connector

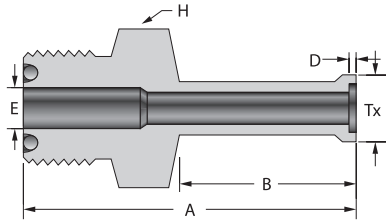

Part No	DO Size	Tube OD	Dimensions, in. (mm)							Pressure Rating Psig (bar)
			A	B	D	E	H	Tx	Wall	
DOBCAW 4-4T	1/4	1/4	1.59 (40.4)	0.78 (19.8)	0.02 (0.5)	0.18 (4.6)	5/8	0.29 (7.4)	0.035	5 100 (351)
DOBCAW 6-6T	3/8	3/8	1.74 (44.2)	0.79 (20.0)	0.03 (0.8)	0.31 (7.9)	15/16	0.41 (10.4)	0.035	3 300 (227)
DOBCAW 8-8T	1/2	1/2	1.75 (44.4)	0.80 (20.3)	0.04 (1.0)	0.40 (10.2)	15/16	0.55 (14.0)	0.049	3 500 (241)
DOBCAW 12-12T	3/4	3/4	1.78 (45.2)	0.80 (20.3)	0.04 (1.0)	0.65 (16.5)	1 5/16	0.80 (20.3)	0.049	2 200 (151)
DOBCAW 16-16T	1	1	2.03 (51.6)	1.00 (25.4)	0.04 (1.0)	0.87 (22.1)	1 5/8	1.06 (26.9)	0.065	2 200 (151)

## Male Connector

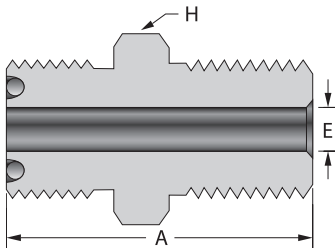

Part No	DO Size	Male NPT	Dimensions, in. (mm)			Pressure Rating Psig (bar)
			A	E	H	
DOBMC 4-2N	1/4	1/8	1.16 (29.5)	0.18 (4.6)	5/8	10 000 (689)
DOBMC 4-4N	1/4	1/4	1.34 (34.0)	0.18 (4.6)	5/8	13 400 (923)
DOBMC 8-6N	1/2	3/8	1.46 (37.1)	0.38 (9.7)	15/16	7 800 (537)
DOBMC 8-8N	1/2	1/2	1.65 (41.9)	0.40 (10.2)	15/16	10 000 (689)
DOBMC 12-12N	3/4	3/4	1.75 (44.4)	0.62 (15.7)	1 5/16	7 300 (502)
DOBMC 16-16N	1	1	1.97 (50.0)	0.87 (22.1)	1 5/8	5 300 (365)

## Bodies Female Connector

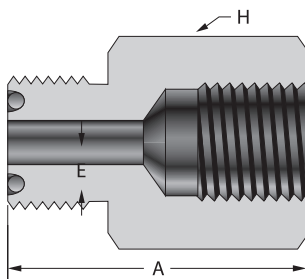

Part No	DO Size	Male NPT	Dimensions, in. (mm)			Pressure Rating Psig (bar)
			A	E	H	
DOBFC 4-2N	1/4	1/8	1.25 (31.8)	0.18 (4.6)	5/8	8 400 (578)
DOBFC 4-4N	1/4	1/4	1.39 (35.3)	0.18 (4.6)	3/4	6 600 (454)
DOBFC 8-6N	1/2	3/8	1.57 (39.9)	0.40 (10.2)	15/16	6 600 (454)
DOBFC 8-8N	1/2	1/2	1.77 (45.0)	0.40 (10.2)	1 1/16	4 900 (337)
DOBFC 12-12N	3/4	3/4	1.93 (49.0)	0.62 (15.7)	1 5/16	4 600 (316)
DOBFC 16-16N	1	1	2.02 (51.3)	0.87 (22.1)	1 5/8	4 400 (303)

## Male Elbow

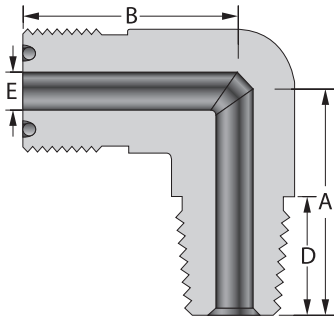

Part No	DO Size	Male NPT	Dimensions, in. (mm)				Pressure Rating Psig (bar)
			A	B	D	E	
DOBLM 4-2N	1/4	1/8	0.87 (22.1)	0.96 (24.4)	0.38 (9.7)	0.18 (4.6)	10 000 (689)
DOBLM 4-4N	1/4	1/4	1.05 (26.7)	0.96 (24.4)	0.56 (14.2)	0.18 (4.6)	8 000 (551)
DOBLM 8-6N	1/2	3/8	1.26 (32.0)	1.26 (32.0)	0.56 (14.2)	0.38 (9.7)	7 800 (537)
DOBLM 8-8N	1/2	1/2	1.45 (36.8)	1.26 (32.0)	0.75 (19.1)	0.40 (10.2)	7 700 (530)
DOBLM 12-12N	3/4	3/4	1.67 (42.4)	1.48 (37.6)	0.75 (19.1)	0.62 (15.7)	7 300 (502)
DOBLM 16-16N	1	1	1.94 (49.3)	1.56 (39.6)	0.94 (23.9)	0.87 (22.1)	5 300 (365)

## Male SAE / MS Connector

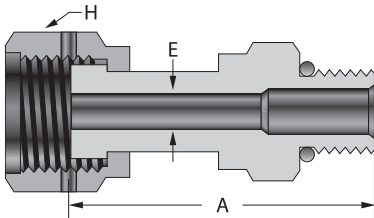

Part No	DO Size	Straight Thread	Dimensions, in. (mm)				Pressure Rating Psig (bar)
			A	C	E	H	
DOBMCS 4-4U	1/4	7/16-20	1.24 (31.5)	0.36 (9.1)	0.18 (4.6)	11/16	4 500 (310)
DOBMCS 4-6U	1/4	9/16-18	1.17 (29.7)	0.39 (9.9)	0.18 (4.6)	11/16	
DOBMCS 8-4U	1/2	7/16-20	1.36 (34.5)	0.36 (9.1)	0.18 (4.6)	1 1/2	4 500 (310)
DOBMCS 8-6U	1/2	9/16-18	1.39 (35.3)	0.39 (9.9)	0.30 (7.7)	1 1/2	
DOBMCS 8-8U	1/2	3/4-16	1.47 (37.3)	0.40 (11.2)	0.40 (10.2)	1	
DOBMCS 12-12U	3/4	1 1/16-12	1.73 (43.9)	0.59 (15.0)	0.62 (15.7)	1 3/8	3 600 (248)
DOBMCS 16-16U	1	1 5/16-12	1.79 (45.5)	0.59 (15.0)	0.85 (21.6)	1 5/8	2 900 (199)

## Male SAE / MS Positionable Elbow

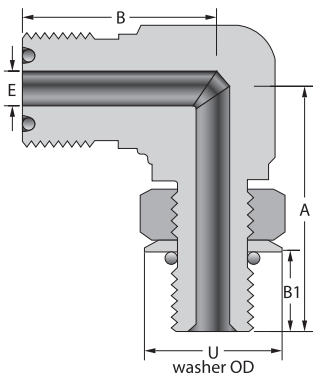

Part No	DO Size	Straight Thread	Dimensions, in. (mm)					Pressure Rating Psig (bar)
			A	B	B1	E	U	
DOBLS 4-4U	1/4	7/16-20	1.19 (30.2)	0.96 (24.4)	0.39 (9.9)	0.19 (4.6)	0.65 (16.5)	4 500 (310)
DOBLS 8-6U	1/2	9/16-18	1.54 (39.1)	1.33 (33.8)	0.44 (11.2)	0.30 (7.6)	0.79 (20.1)	3 600 (248)
DOBLS 8-8U	1/2	3/4-16	1.65 (41.9)	1.33 (33.8)	0.50 (12.7)	0.40 (10.2)	1.01 (25.7)	
DOBLS 12-12U	3/4	1 1/16-12	2.13 (54.1)	1.53 (38.9)	0.66 (16.8)	0.62 (15.7)	1.44 (36.6)	2 900 (199)
DOBLS 16-16U	1	1 5/16-12	2.31 (58.7)	1.72 (43.7)	0.66 (16.8)	0.87 (22.1)	1.73 (43.9)	2 300 (158)