

DP C240.CAN



CONTENT

Content.....	1	Button definition.....	7
Introduction.....	2	Normal operation.....	7
Overview drawing.....	3	Functions setting.....	10
Specifications.....	4	BESST connection.....	14
Functions overview.....	5	Error code definition.....	15
Normal indication area.....	6	Installation.....	16

INTRODUCTION

- Name: Intelligent display
- Model: DP C240.CAN
- Scope: EN15194 electrical power assistance cycle
- Appearance: Black ABS housing body, acrylic top cover, silicon rubber button.



- Number rule on the back of the display
Number on the middle of display back, number is divided into two lines:
A. Up line (as below)
DP C240.C 1.0
① DP C240.C: BAFANG display mode
② 1.0: Hardware version number
B. Down line (as below)
607K1Q7280001
① 607: Wire length and connector model
is 750mm M5.2
② K1: Internal identity number

③ Q7280001: Production date is
28st July, 2016; SN is 0001

- Display P type wire label number rule:
Number on the middle of P type label, number is divided into up row and down row and QR code is at right side (as shown in the below figure)



Content of QR code:

DPC240I10101.0
PD2526051205
DP C240.C 1.0
607K1Q7280001

The first line:

DPC240I10101.0 - Software version

The second line:

PD2526051205 - Parameter code

The last two lines:

DP C240.C 1.0 / 607K1Q7280001 - SN

OVERVIEW DRAWING



SPECIFICATIONS

- Rated voltage: 36V/43V/48V DC
- Rated current: 10mA
- Maximum operating current: 30mA
- Power-off leakage current: <1uA
- Operating current supplied to controller: 50mA
- Operation temperature: -20 °C~45 °C
- Storage temperature: -30 °C~70 °C
- IP level: IP65
- Storage ambient humidity: 30%-70%

FUNCTIONS OVERVIEW

- CAN bus communication platform, Three-button console which is with BOOST mode is more user-friendly.
- Speed indication: Includes maximum speed, average speed.
- Unit switch between imperial and metric.
- Intelligent battery capacity indication.
- Control and indication for the headlight.
- 5 levels of backlight brightness setting.
- Indication for power assistance level with 6 levels:0/1/2/3/4/5.
- Indication for trip: To indicate single-trip distance, total distance and remaining distance.
- Multiple data indication: Indication for the remaining distance, Indication for the consumption of energy CALORIES. (Note: If the display has this function.)
- Record and indication for the error information.
- Button with feedback of haptic vibration.
- Control and indication for push assistance.
- Parameters resettable with BESST BOX.
- USB charging port: $\leq 5V$, $\leq 1A$.
- Dual Bluetooth integrated.

NORMAL INDICATION AREA

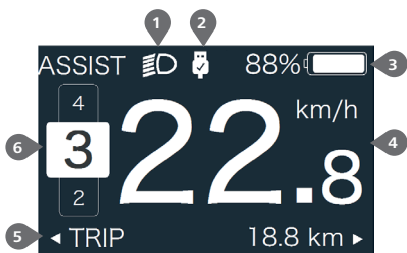

1 Headlight indication:

Indicate the working status of headlight.

2 USB connection indication:

Indicate the status of USB connection to peripheral device.

3 Battery capacity indication:

Indicate the current remaining capacity.

4 Real-time speed indication:

To indicate the real-time speed.

5 Multiple data indication:

To indicate single (TRIP), Total range (ODO), max speed (MAX), average speed (AVG), remaining distance(RANGE), output power (POWER), energy consumption(Cal), riding time(TIME); (Notice: Calory data will only come out when the display recognize the sensor as torque sensor or the signal of torque in 10s after switch on;Remaining distance will only come out when the display get the data of range.)

6 Assistance level indication:

To indicate the current support level, this display has 0/1/2/3/4/5 mode, the chosen level will be indicated in amplifying and reverse color Arabic number; No chosen level indication means level 0, no power assistance.  means push assistance mode.

BUTTON DEFINITION

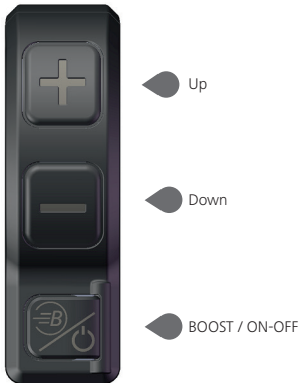

NORMAL OPERATION

“Press and hold” means press and hold for more than two seconds, briefly press means press for less than 0.5 second.

- **ON/OFF:**

Press and hold “ON/OFF” button, then display is working and offering power to controller; On the contrary, press and hold this button, then display is off and the current consumption is less than 1uA .

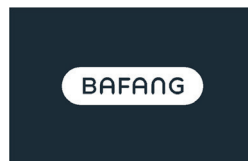

Welcome interface

- **Power assistance level switch:**

After switching on the display, briefly press “+” or “-” to switch the level to change the assistance output power. The weakest level is 0, the most powerful level is 5. When the display is on, the default mode is level 1, here “0” means no power assistance. (as shown in the figure below)



- **Multiple function interfaces switch:**

Briefly press “BOOST” button to switch to different data interfaces, then circularly to show single trip distance (Trip,km) → total distance (ODO,km) → maximum speed (MAX,km/h) → average speed (AVG,km/h) → remaining distance (RANGE,km) → energy consumption (CALORIES/CAL,KCal) → riding time (TIME,min) → real-time output power (POWER,w).



- **Headlight/Display backlight switch:**

Press and hold “+” to turn on the display backlight as well as headlight, this moment you will see the symbol of headlight in the screen; On the contrary, press and hold “+” again to turn off the display backlight and the headlight (If the display is turned on in a dark environment, the display backlight/headlight are turned off manually, they also need to be turned on manually afterwards).



Interface of headlight and backlight

Push assistance mode:

Press and hold “-” button to enter into push assistance mode, the symbol  is displayed, when release “-” button, will exit the push assistance mode and go back to the current assistance level.

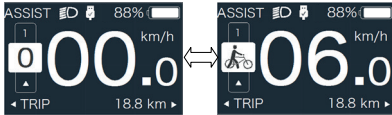

Push assistance function

BOOST mode:

While riding and speed reaching to 25km/h, press and hold “BOOST” button with 2 seconds to activate, then motor will give 100% output power and flowing without pedaling, it feels more like a constant strong push in the back; On the contrary, release the button and exit from BOOST mode.



BOOST mode

Battery capacity indication:

The battery remaining capacity will be indicated as the exact percentage, in addition, the frame of the symbol will flash at 1Hz when capacity is less than 5%, means the battery needs to be charged.

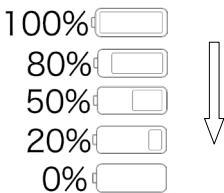

USB charging:

Plug the USB cable to display and smart peripheral devices to charge, but the display must be switched on. (≤5V, ≤1A)



USB charging indication

Bluetooth connection:

① This display has Bluetooth module integrated and connectable to BAFANG’s own smart phone application “BAFANG GO”. In addition, the SDK is open for customer to develop APP individually.

② This display is also connectable to the chest belt and catch real-time heart beat data from the chest belt and display it and send the data to smart phone.

③The list of data transmit from display to smartphone as below:

Item	Data
1	Speed
2	Capacity
3	Support level
4	Data of battery
5	Output of sensors
6	Remaining range
7	Calory
8	Component info.
9	Current
10	Heart beat
11	Trip
12	ODO
13	Headlight status
14	Error code

FUNCTIONS SETTING

- Preference setting

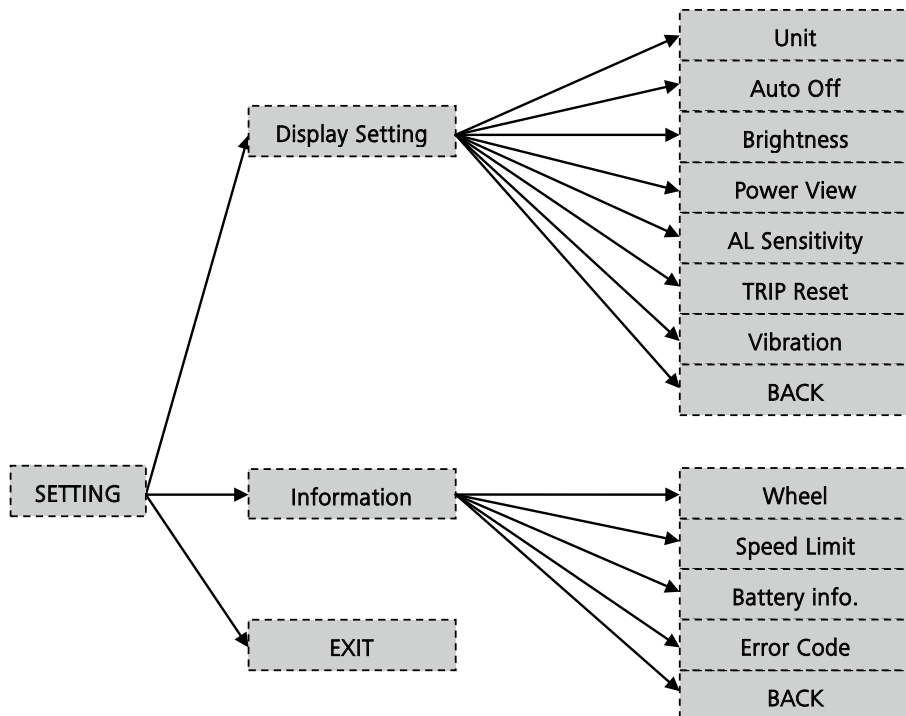

Press and hold “+” & “-” button synchronously to enter into Display Setting interface, and briefly press “+” or “-” to switch to from “Setting” to “EXIT” and then briefly press “ON/OFF” button to confirm the operation.

- Display Setting
- Information
- Exit

Switch interface

- Unit
- Auto Off
- Brightness
- Power View
- AL Sensitivity

Settable menus

- Power View
- AL Sensitivity
- Trip Reset
- Vibration
- Back

- Wheel
- Speed Limit
- Battery Info
- Error Code
- Back

Viewable data

- **“Unit”-unit switch between imperial and metric**

Briefly press “+” or “-” to go to “UNIT”, and then briefly press “ON/OFF” to switch between “Metric”/ “Imperial”, then briefly press “ON/OFF” to confirm selection and save the setting and exit back to the “UNIT”. Press and hold “+” and “-” synchronously to save and exit back to the main interface, or you can also select “BACK” → “EXIT” to exit back to the main interface.



“Metric”/“Imperial” switch

- **Auto Off**

Briefly press “+” or “-” to go to “Auto Off”, and then briefly press “ON/OFF” to select among “OFF”/“9”/“8”/“7”/“6”/“5”/“4”/“3”/“2”/“1” ten levels, then briefly press “ON/OFF” to confirm selection and save the setting and exit back to the “Auto Off”. Press and hold “+” and “-” synchronously to save and exit back to the main interface, or you can also select “BACK” → “EXIT” to exit back to the main interface.

Notice: “OFF” means this function is off, the unit is minute.

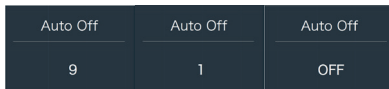

- **Brightness setting**

Briefly press “+” or “-” to go to “Brightness”, and then briefly press “ON/OFF” to select among “100%”/“75%”/“50%”/“30%”/“10%” five levels, then briefly press “ON/OFF” to

confirm selection and save the setting and exit back to the “Brightness”. Press and hold “+” and “-” synchronously to save and exit back to the main interface, or you can also select “BACK” → “EXIT” to exit back to the main interface.

Notice: “10%” is the weakest brightness and “100%” is the strongest brightness.

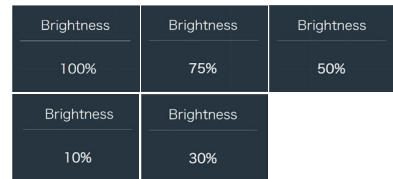

- **Indication switch of output with current or power**

Briefly press “+” or “-” to go to “Power View”, and then briefly press “ON/OFF”, then briefly press “+” or “-” to switch between Power and Current, then briefly press “ON/OFF” to confirm selection and save the setting and exit back to the “Power View”. Press and hold “+” and “-” synchronously to save and exit back to the main interface, or you can also select “BACK” → “EXIT” to exit back to the main interface.

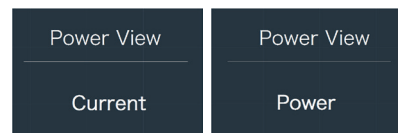

Switch between Current and power

- **Light sensitivity setting**

Briefly press “+” or “-” to go to “Sensitivity”, and then briefly press “ON/OFF” to select among “0”/“1”/“2”/“3”/“4”/“5” five levels, then briefly press “ON/OFF” to confirm selection and save the setting and exit back

to the "Sensitivity". Press and hold "+" and "-" synchronously to save and exit back to the main interface, or you can also select "BACK" → "EXIT" to exit back to the main interface.

Notice: "0" means light sensor is off. Level 1 is the weakest sensitivity and level 5 is the strongest sensitivity.

AL Sensitivity	AL Sensitivity
5	1
AL Sensitivity	AL Sensitivity
0	OFF

- **Trip reset - to clear the single trip distance**

Briefly press "+" or "-" to go to "TRIP Reset", and then briefly press "ON/OFF" to switch between NO/"YES" ("YES"- to clear, "NO"-no operation), then briefly press "ON/OFF" to confirm selection; After confirmation, briefly press "ON/OFF" again to save the setting and exit back to the "TRIP Reset". Press and hold "+" and "-" synchronously to save and exit back to the main interface, or you can also select "BACK" → "EXIT" to exit back to the main interface.

Notice: The riding time(TIME), average speed (AVG) and maximum speed (MAXS) will be reset simultaneously when you reset TRIP.

Trip Reset	Trip Reset
Yes	No

- **Vibration setting**

Briefly press "+" or "-" to go to "Vibration", and then briefly press "ON/OFF" to select between ON and OFF (ON means vibration button is on; OFF means vibration button is off), then briefly press "ON/OFF" to confirm selection and save the setting and exit back to the "Vibration". Press and hold "+" and "-" synchronously to save and exit back to the main interface, or you can also select "BACK" → "EXIT" to exit back to the main interface.

Vibration	Vibration
No	Yes

- **Wheel size review**

After entering into "Information" menu, then briefly press "+" or "-" to go to "Wheel Size", and then briefly press "ON/OFF" to review the wheel size default, then briefly press "ON/OFF" to exit back to the "Wheel Size". Press and hold "+" and "-" synchronously to exit back to the main interface, or you can also select "BACK" → "EXIT" to exit back to the main interface.

Wheel
26 INCH

- **Speed limit review**

After entering into "Information" menu, then briefly press "+" or "-" to go to "Speed Limit", and then briefly press "ON/OFF" to review the speed limit default, then briefly press "ON/OFF" to exit back to the "Speed

Limit". Press and hold "+" and "-" synchronously to exit back to the main interface, or you can also select "BACK" → "EXIT" to exit back to the main interface.

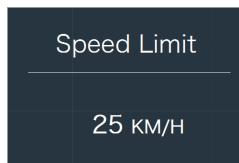

- **Check record of error code**

After entering into "Information" menu, then briefly press "+" or "-" to go to "Error Code", and then briefly press "ON/OFF" to review the last ten error codes record from "E-Code0" to "E-Code9", then briefly press "ON/OFF" to exit back to the "Information". Press and hold "+" and "-" synchronously to save and exit back to the main interface.

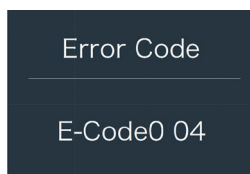

- **Battery data review**

After entering into "Information" menu, then briefly press "+" or "-" to go to "Battery Info.", and then briefly press "ON/OFF" to enter, then briefly press "+" to review the battery data from b01 → b04 → b06 → b07 → b08 → b09 → b10 → b11 → b12 → b13 → d00 → d01 → d02 → ... → dn, then briefly press "ON/OFF" to exit back to the "Battery Info.". Press and hold "+" and "-" synchronously to save and exit back to the main interface, or you can also select "BACK" → "EXIT" to exit back to the main interface.

Notice: If the the battery is not a smart battery, you won't see any data from battery.

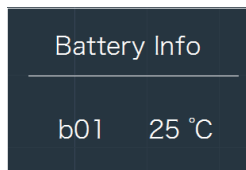

Code	Code definition	unit
b01	Current temperature	°C
b04	Total voltage	V
b06	Average current	A
b07	Remaining capacity	Ah
b08	Full charge capacity	Ah
b09	Relative SOC	%
b10	Absolute SOC	%
b11	Cycle	times
b12	Maximum not charging time	Hour
b13	Recently not charging time	Hour
d00	Cell quantity	
d01	Voltage of cell 1	V
d02	Voltage of cell 2	V
...	...	V
dn	Voltage of cell n	V

BESST CONNECTION

- If it is successful for display to connect to BESST, the display will show: “Connected OK!”.

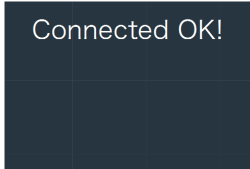

- If the display show “Read OK!” ,it means it is successful for BESST BOX to read information from the display. The information includes customer’s number, display type, wheel size, speed limit, software number and hardware number.

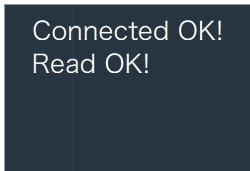

- If the display show “Write OK” , it means it is successful for BESST BOX to write basic information into the display. The information includes customer’s number, wheel size, speed limit.

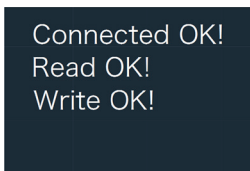

- When writing SN, if the display show “Write OK!”, it means it is successful for BESST BOX to write SN into the display.

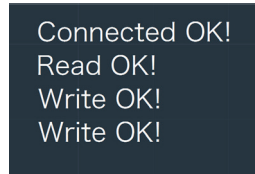

- When reading SN, if the display show “Read OK” , it means it is successful for BESST BOX to read SN from the display.

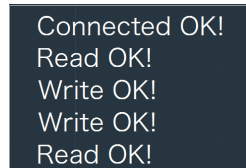

- If the display enters into test mode, it will switch to normal operation interface.
- Firmware update.

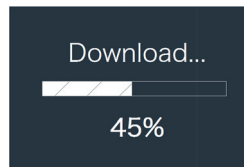

ERROR CODE DEFINITION



DP C240.CAN display can show e-bike faults. When a fault is detected, the icon  will be displayed. One of the following error codes will be displayed.

Error	Explanation	Troubleshooting
03	Brakes enabled	Check whether a brake cable is stuck.
07	High voltage protection	Bring your Pedelec to your dealer or to a specialist to have the error fixed.
08	Fault with motor hall sensor inside	Bring your Pedelec to your dealer or to a specialist to have the error fixed.
10	The motor temperature reaches to the max protection value	Stop the e-bike for a rest.
12	Fault with current sensor inside controller	Bring your Pedelec to your dealer or to a specialist to have the error fixed.
13	Fault with temperature sensor inside battery	Bring your Pedelec to your dealer or to a specialist to have the error fixed.
21	Fault with wheel speed detecting sensor	Bring your Pedelec to your dealer or to a specialist to have the error fixed.
22	BMS communication fault	Bring your Pedelec to your dealer or to a specialist to have the error fixed.
25	Torque sensor torque signal fault	Bring your Pedelec to your dealer or to a specialist to have the error fixed.
26	Torque sensor speed signal fault	Bring your Pedelec to your dealer or to a specialist to have the error fixed.
30	Communication fault	Bring your Pedelec to your dealer or to a specialist to have the error fixed.

Note: Error Code 10 will probably appear on the display when the e-bike is climbing for a long time. This indicates that the motor temperature has reached the protection value, in which case the user needs to stop the e-bike for a rest. If the user continues to run the e-bike, the motor will automatically cut off the power.

INSTALLATION

- Fix the display unit onto the support bracket with M3 screw.

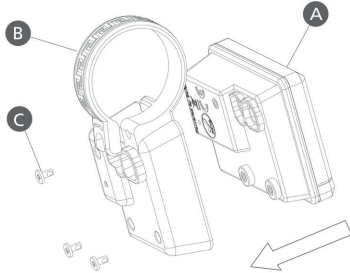

- A. Display unit
- B. Support bracket
- C. M3 screw

- Plug 5-pin and 6-pin connectors into the display unit.

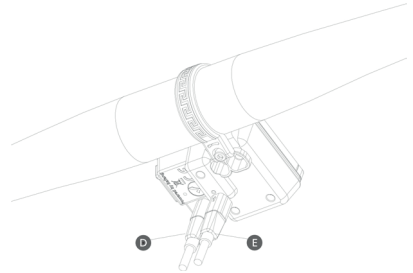

- F. 5-pin IP connector
- G. 6-pin IP connector

- Pull out the clamp of the support bracket and put it around the handlebar and then fix it with M3 screw.($\leq 1\text{N}\cdot\text{m}$)

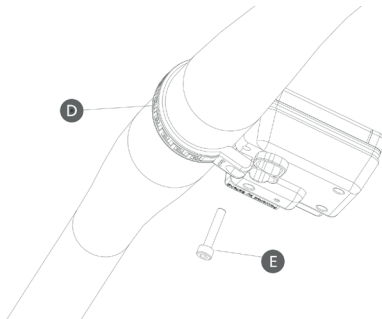

- D. Clamp
- E. Hex socket screw M3*30