

# Smart Toilet Manual

## Model

Thanks for choosing our product

And please read the instructions carefully before using.

The pictures are for reference only, please refer to the actual product

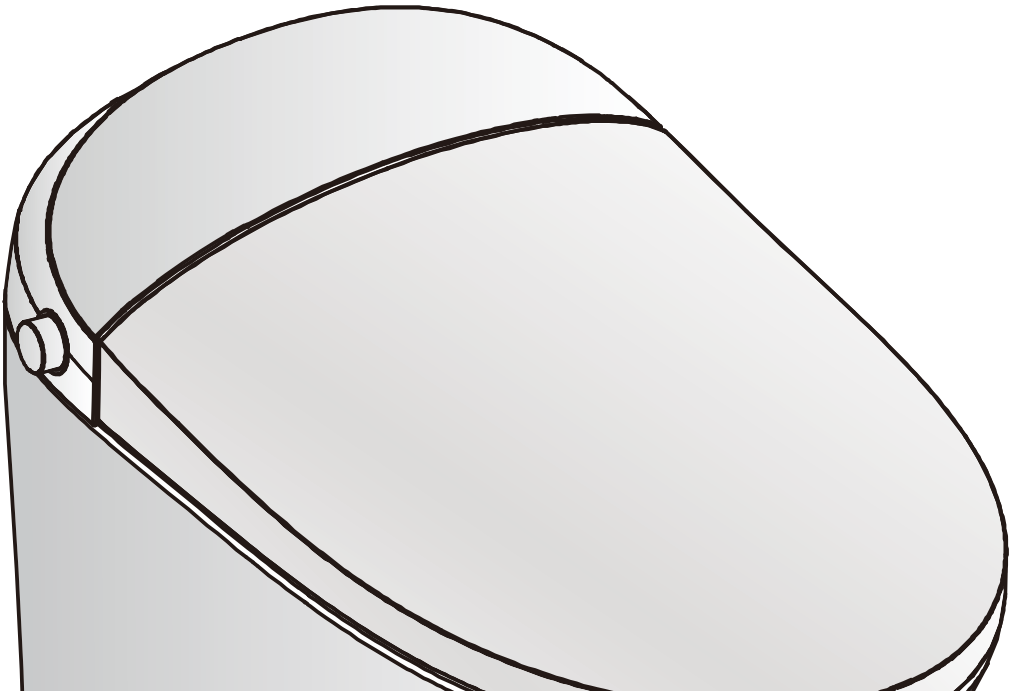

# Contents

---

## Before use

---

|                             |   |
|-----------------------------|---|
| Safety precautions .....    | 1 |
| Overall sketch .....        | 6 |
| Function introduction ..... | 7 |

## Installation guide

---

|                           |   |
|---------------------------|---|
| Toilet installation ..... | 8 |
|---------------------------|---|

## Operation

---

|                                |    |
|--------------------------------|----|
| Operation introduction .....   | 11 |
| Preparation .....              | 11 |
| Product use .....              | 12 |
| Troubleshooting .....          | 13 |
| Cleaning and Maintenance ..... | 14 |

## Appendix



---

|                             |    |
|-----------------------------|----|
| Product specification ..... | 17 |
| Packing list .....          | 18 |



# Safety precautions



Please read the “safety precautions” carefully before use, all the precautions listed here are connected to safety. It's important and must be followed.

## Sign and meaning

|   |                |   |
|---|----------------|---|
|  | <b>Warning</b> | Represents improper operations by ignoring the instructions may result in death or injury               |
|  | <b>Notice</b>  | Represents improper operations by ignoring the instructions may result in body injury and property loss |

The following signs are used for important safety precautions.

| Sign  | meaning                             |
|---|-------------------------------------|
|  | It represents not allowed, “forbid” |
|  | It represents enforced to do        |

|  <b>WARNING</b> |  |
|--|--|
|               | <p>Please do not touch the electrical outlet with wet hand</p> <ul style="list-style-type: none"> <li>• Or it may cause electric shock</li> </ul> <p>Please do not pour water, hot water or detergent on the top of the toilet and electrical outlet</p> <ul style="list-style-type: none"> <li>• Or it may cause fire, electric shock, heat or short circuit</li> <li>• Or it may cause injury and indoor water seepage because of the damage of product</li> </ul> <p>Never attempt to disassemble, repair, or alter the product yourself.</p> <ul style="list-style-type: none"> <li>• Or it may cause fire, electric shock, heat or short circuit</li> </ul> <p>Please do not install the toilet in car, ship or any other moving object.</p> <ul style="list-style-type: none"> <li>• Or it may cause fire, electric shock, short circuit or fault.</li> <li>• Or the ceramic, seat and main part will be damaged because of falling down.</li> </ul> <p>Stop using while it breakdown</p> <p>Under the following condition, please disconnect the power supply and turn off the water angle valve</p> <ul style="list-style-type: none"> <li>— Water leakage from pipe or inside of the product</li> <li>— crack or damage on the product</li> <li>— unusual sound or smell</li> <li>— Smoke</li> <li>— Unusual heating</li> <li>— Block</li> <li>— Fall out of the cushion</li> </ul> <ul style="list-style-type: none"> <li>• Continue using the toilet by ignoring the faults may result in fire, electric shock, heat, short circuit, injury and indoor water seepage</li> </ul> |



## WARNING



Please don't use seawater and other water except tap water or drinkable well water(underground water)

- Or it may cause skin inflammation or fault

Please do not touch the electrical plug while thunder

- Or it may cause electric shock

Please do not let the water inlet soft pipe connect to the electrical plug and outlet

- Or it may cause fire, electric shock, heat, short circuit because of moisture condensation

Please do not destroy power cable or plug

Does not strike, yank, twist, excessively bend, damage, or alter the electrical cords. Also, do not place anything heavy on, bind or pinch the cords.

- Or it may cause fire, electric shock, heat and short circuit if it's broken

Please do not use a loose or faulty electrical outlet.

- Or it may cause fire or short circuit.

Please use the electrical outlet and wire appliance in specified area.

- Or it may cause fire because of wire appliance is not in the rule of outlet.

Please do not use any power supply other than 120V,60Hz

- Or it may cause fire or heat.

Please do not put finger or anything else into the warm air outlet.

Please do not put objects or clothes on the air outlet or cover it.

- Or it may cause scald, electric shock or accessories burn down.

Please keep cigarettes and other open flames away from the product

- Or it may cause fire.



This is an electrical product, please do not install it in a place where is easily get wet or with high humidity. If installed in bathroom, please also install ventilator to maintain the bathroom ventilation.

- Or it may cause fire or electric shock.

The product must be connected to cold water supply.

- Or it may cause body burn or machine fault.

The product must be connected to the ground correctly.

- If not connected to the ground, it may cause electric shock.

The ground processing here requires the ground resistance under 100Ω, the earth wire of switchboard is over Ø1.5mm, with copper material.  
(please entrust installation company to do the job)



## WARNING

Please confirm if the electrical outlet is connected to the ground

- Or it may cause electric shock because of fault or short circuit.

The outlet for power wire should obey the following rules.

- Or it may cause fire or electric shock.
  - a. Please use high sensibility and fast response leakage switch (rated induced currents below 15mA) or insulating transformer (1.5kVA~3kVA) to protect outlet loop.
  - b. Please reserved the installation place for outlet and keep it away from bathtub.
- \* Please confirm above a , b wiring projects are finished. Or please entrust the engineering contractor to do this job.

The electrical plug should be inserted to the outlet firmly.

- Or it may cause fire, heat or short circuit.

Please hold the plug not the wire when pulling out the plug.

Please do not grasp the wire to pull out the plug.

- Or it may cause fire or heat because of broken wire.

If the power soft wire is broken, to avoid danger, please ask the maintenance department of company or similar departments to replace it.

Please be sure to turn off the power while doing the maintenance or spot check.

- Or it may cause electric shock or accessories burn down.
- \* Not include “ nozzle clean”

Disabled people or who is lack of experience or common sense ( including children) should be accompanied with personnel guardian while using this product.

- Or it may cause scald, electric shock, fire and body injury.

Please do not let children play this product.

- Or it may cause scald, electric shock, fire and body injury.

Do not throw lighted cigarettes and other flaming material into the toilet.

- Or it may cause fire.





## NOTICE

Please do not use the product when it's loose.

- Or the toilet and seat may separate and fall off to cause body injury

Please do not touch broken area.

- Or it may cause injury, please replace it as soon as possible.

Please do not impact forcefully, put heavy subject or stand on the product

- Or it may cause product damage, fall down or body injury
- Or it may cause body injury or indoor water seepage

Please do not pull the product by holding the seat or cover.

Please do not open the seat and cover when something on the product.

- Or the main body may fall off to cause body injury.

Please use kitchen detergent(neutral) to maintain the plastic part(seat cover, etc) and water inlet soft hose, please do not use the following materials [ bathroom detergent, house detergent, gasoline, banana oil, cleaning powder and nylon brush and so on]

- Or it may damage the plastic parts, cause cracks to body injury for fault
- Or it may cause water leakage because of damaged soft hose

To avoid sudden water leakage, please do not remove the water inlet filter when angle valve is open

[please refer to cleaning instruction of water inlet filter]

- Or the water may spray out

Please do not crush or bend water inlet hose

- Or it may cause water leakage

Please use the new hose that put inside the accessory box, the old one isn't recycled.

- Or it may cause water leakage

Please do not pour hot water into toilet

- Or it may cause body injury or indoor water seepage because of toilet damage

Please do not flush with big amount of toilet paper or other subjects except sewage and small amount toilet paper.

- Or it may cause body injury or indoor water seepage because of toilet damage

Please do not lean on the toilet cover while using

- Or it may destroy the seat cover.





## NOTICE

Please close the angle valve when water leaking

When room temp is under 0°C, to avoid piping or soft hose damaging because of frozen, anti freezing measures should be adopted.

- It may destroy main body or piping, leading to water leakage if water inlet soft hose is frozen.
- To avoid damage, please pay attention to room temp adjustment.

When not use for a long time, please must drain the inlet soft hose, and cut the power.

- When using next time, please open the angle valve and let water connected first. or it may cause skin inflammation because of bad water quality.
- It may cause fire or heat if the power supply is always connected.

Please must confirm if the filter has screwed to right position when install it.

- It may cause water leakage if not screwed tight.

When the toilet drain outlet is blocked, cut off the power then clean the obstruction

- Or the sewage may overflow, cause indoor water seepage because of auto flush function.
- Use the professional tools sold in the market to clean the obstruction.

Flush the toilet after pee

- Or it may cause difficulty in clean the toilet, block the drain outlet or sewage overflow, result in indoor water seepage.

Use the dried towel to clean the pee, dee, detergent, water and etc on the floor.

- Or it may leave dirt on the floor or corrode the floor.



# Overall Sketch

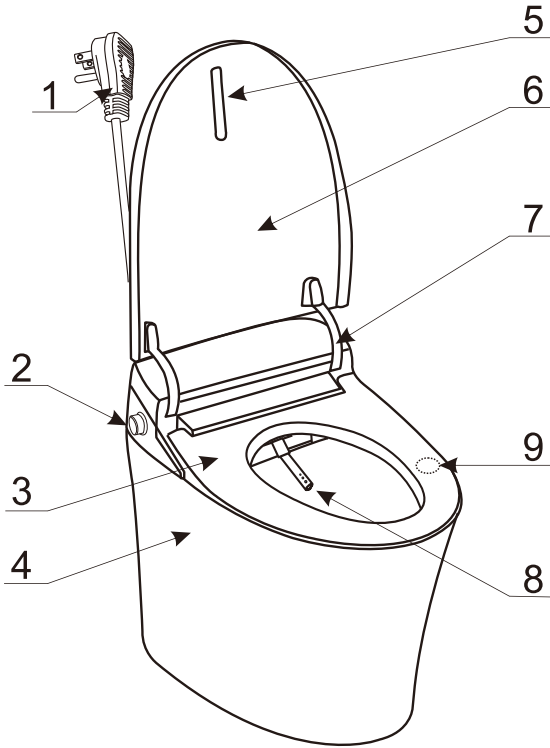

- 1 Power plug
- 2 Knob
- 3 Seat
- 4 Toilet bowl
- 5 Cushion pad
- 6 Toilet lid
- 7 Damper
- 8 Nozzle
- 9 Sensing area

## NOTICE

The contents described in this manual include but are not limited to product material, process, functional characteristics, etc., which may be different from the actual product due to process improvement or product upgrade. Please refer to the actual product.



# Functions introductions

| Function                | Introduction   |
|-------------------------|--|
| Rear wash               | Provide rear cleansing   |
| Front wash              | Provide cleansing by front cleansing nozzle with a gentle spray                                |
| Seat sensor             | Functions activated by sitting on the seat   |
| Soft close              | Damper in the seat and cover, to make it close softly  |
| Auto flush              | Auto bowl unit cleaning after users walk away  |
| Flush even if power off | Push side button to flush when power off   |
| Ceramic bowl pre-wet    | Water come out of the nozzle to make the ceramic bowl wet                                      |
| Nozzle self-clean       | Provide nozzle self-cleaning before washing  |
| Foot sensor flush       | When the foot has crossed the sensor switch at the bottom, the flushing function is activated. |
| Power switch control    | Knob-operated switch that controls the machine   |

# Installation guide

## ◆ Toilet installation ◆

### ※ Supply stop installation

1. Turn on the old supply stop and flush for 1 minute, to flush out any sundries that may damage the toilet structure.
2. Turn off the supply stop and remove it.
3. Wrap sealing tape on the end(1/2" NPT male) thread of the water supply pipe(not provided) to ensure good sealing performance. Screw the adapter onto the water supply pipe,ensuring that the direction of the adapter arrow is as shown in the figure.
4. Use Teflon tape to ensure good sealing performance.Make sure start wrapping at the end of the fitting,covering the end to prevent the thread from seizing.For the joint assembly,you should tighten the threaded joint 1-2 turns beyond finger tight,be careful do not over tighten.

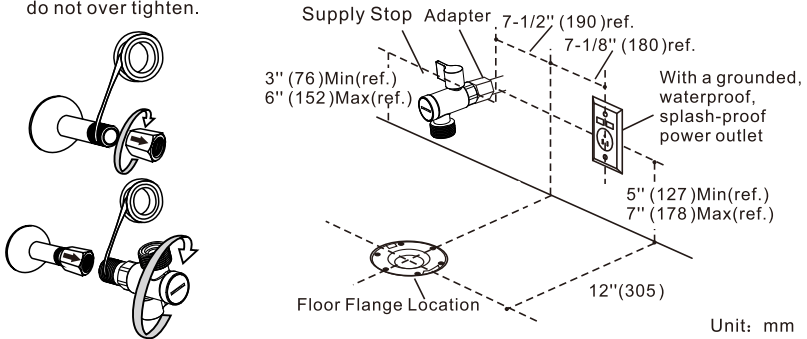

### ※ Confirm water flow

1. Install a matching hose, which is guided to a bucket of 3 gallons(11.4L) or more.  
If you cannot find a matching hose, you can use a cloth to cover the outlet of the supply stop and place the bucket under the valve.
2. Turn on the supply stop. Ensure that the water can outflow at least 1 gallon within 10 seconds.
3. If the water pressure is too low, it is recommended to remove the flow regulator of the supply stop or use a booster pump to increase the water pressure.
4. Close the supply stop .
5. Remove the installed hose.

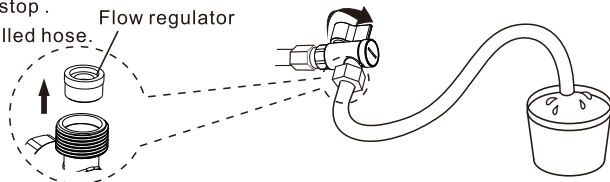

## ✳ Install the toilet

1

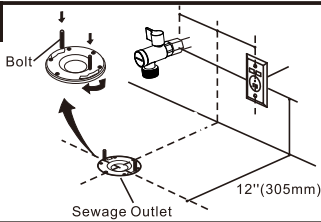

For new installations, toilet flanges need to be installed.  
Install flange bolts.

2

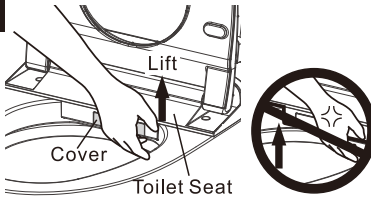

Lift the toilet seat-lid assembly from the toilet. Lift from the interior, back right.  
Note: Do not excessively pull the cover when lifting the toilet seat-lid assembly.

3

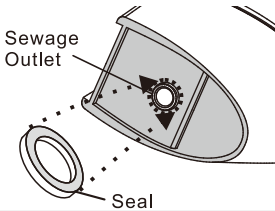

Install a sealing ring under the toilet.

4

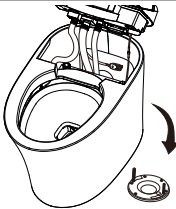

Install the toilet to the flange and ensure that the bolts are aligned with the holes in the toilet.  
(from the top)

5

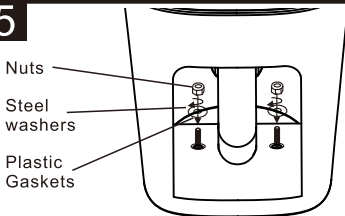

Use a wrench to lock nuts and other accessories to the fixing bolts.  
(from the top)

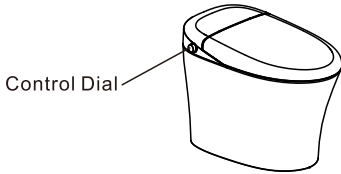
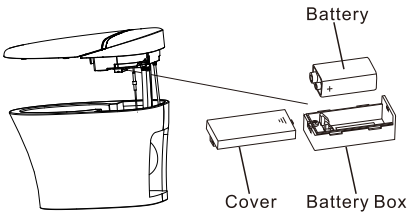
**6**

1. Carefully remove the cover of the battery case.
2. Connect and install the battery and slide the cover back to the battery box.
3. Press the control dial on the side to confirm that flushing can be normal.

**Note:**

- Use alkaline battery.
- This battery is used to maintain the flushing function in the event of power failure.
- Don't throw used batteries into the garbage can, please throw them into your local battery collection center.

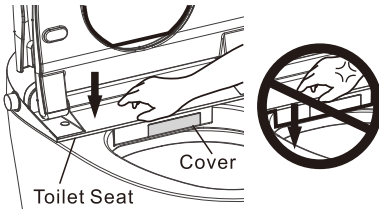
**7**

- Reinstall the toilet seat-lid assembly to complete the toilet installation.  
 Note: Do not push too hard when putting back the toilet seat-lid assembly.

### ※ Connect the water inlet pipe

Connect the water inlet hose to the supply stop.

**Note:**

1. After tightening by hand, turn the nut 1/4 turn with a wrench.
2. Open the supply stop.
3. Check for leaks.
4. Apply silica gel to the bottom of the toilet. Wait for 24 hours to dry.

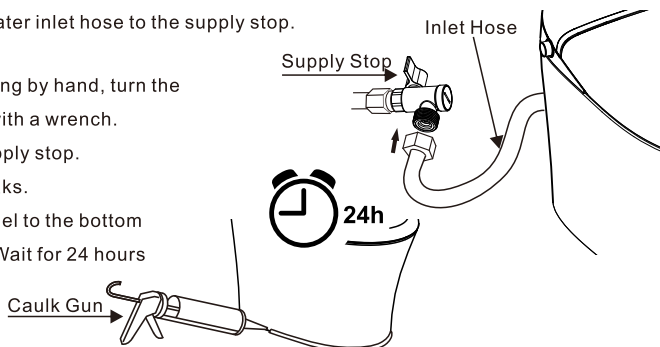

# Operation

## ◆ Operation introduction

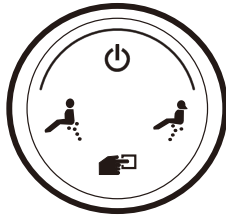

knob

## ◆ Preparation

1. Open the angle valve



Switch to this position

2. Confirm power plug is well plugged into the electric outlet.

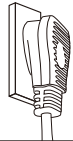

## ◆ How to use

### Sit on the seat

Seat Sensor react automatically when sitting on the seat.  
Water comes out to pre-wet the inner ceramic bowl.

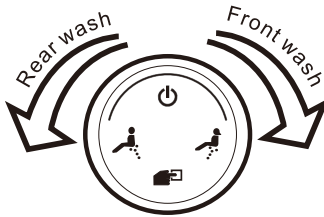

#### When seated

- Rotate the knob forward, the nozzle extends to start front wash.
- Rotate the knob back, the nozzle extends to start rear wash.
- When in the rear wash/front wash, press the knob to stop the wash.

#### When leaving your seat

- Turn the knob forward/back and hold for 3 seconds to start the nozzle cleaning, the nozzle is extended, and the nozzle is cleaned with running water. At this time, a brush can be used for cleaning.
- Press and hold for 3 seconds to turn off the machine.

#### When shut down

- Turning the knob forward/ backward /pressing and other operations will turn the machine on.

#### When in standby

- Press the knob once to start a large amount of water flushing.
- Double-click the knob 2 times to start small water flushing.

## Buzzer

Buzz once: Sit on seat condition, all the functions are available.

Buzz twice: Off the seat condition, parts of the functions are available.

Buzz three times or more: There are faults of the product.

Reminder

Buzzer only works when operate on remote controller or side button or initialization.

## Foot sensor flush

Operating instruction:

When the foot has crossed the sensor switch at the bottom, the flushing function is activated.

Reminder: This function doesn't work when seated.



## ◆ Trouble shooting ◆

| SITUATION                         | REASON   | PROCESS  |
|-----------------------------------|--|--|
| No power                          | The electrical outlet is not connect to power supply or the plug is not insert to the bottom | Check if the electrical outlet is connected to the power supply; press the reset key on the plug |
| No water comes out while cleaning | Low pressure of water supply   | Raise the water pressure   |
|                                   | Water inlet filter blocked   | Remount and clean the filter according to the instruction  |
| Seat and cover are loose          | Fixed bolts are loose  | Tighten the bolts  |
| No response when pressing the key | Key fault  | Reboot or contact ascendant  |
| Water leakage                     | Shutoff valve, water supply hose and water separator are not well connected                  | Reconnect  |

# Cleaning and Maintenance

## • Toilet bowl cleaning

- ◆ Please make sure the electrical plug is taken out
- ◆ Please use wet soft cloth to wipe the toilet shelf and seat.  
The dirt should be cleaned as soon as possible, if it's difficult to clean, you can use neutral detergent.

## • Nozzle Cleaning

- ◆ Nozzle cleaning  
Turn the knob forward/back and hold for 3 seconds to start the nozzle cleaning, the nozzle is extended, and the nozzle is cleaned with running water. At this time, a brush can be used for cleaning.

Attention:  
Do not use steel brush to clean

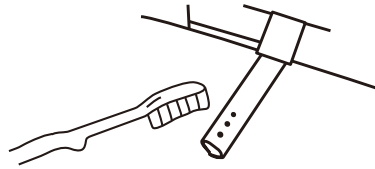

## • Cleaning the filter

When the water pressure is too low or insufficient, please clean the filter.

### 1 Close the angle valve and stop water supply

Notice: Do not remove the filter without closing the angle valve.  
---Otherwise water will spray out.

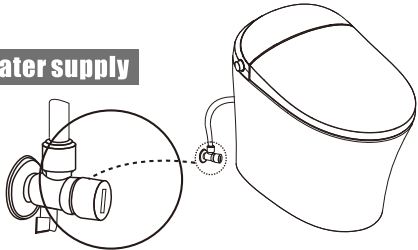



# 2

## Remove the filter

Unscrew the cover of the filter by straight screwdriver and then pull out the cover as below:

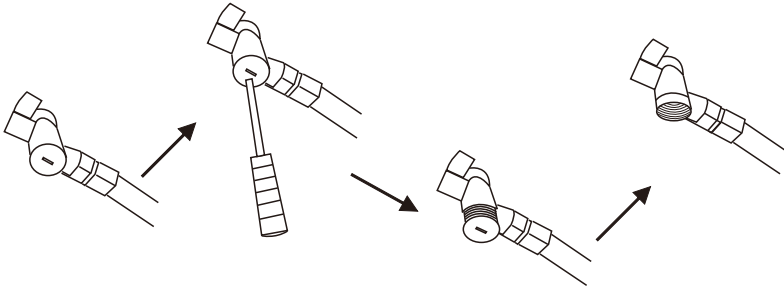

# 3

## Clean the filter

Get the filter out and clean it thoroughly.  
-----Flush off dirt or clean the filter by toothbrush

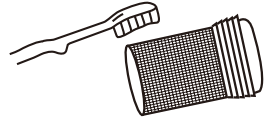

Note: Do not use any cleaning agents. Clean it with water only.  
Do not crush the filter when cleaning in case of distortion.

# 4

## Reattach the filter

Reinstall filter based on the removal sequence.

Notice: Open the shutoff valve after installation and confirm there's no water leakage.

## • Replace back up battery

### Steps

1. Pull out power plug.
2. Lift toilet seat lid.
3. Take out battery cover.
4. Put battery in right position.
5. Press flush button, be sure it can flush normally.
6. Put cover back and fix toilet seat lid.

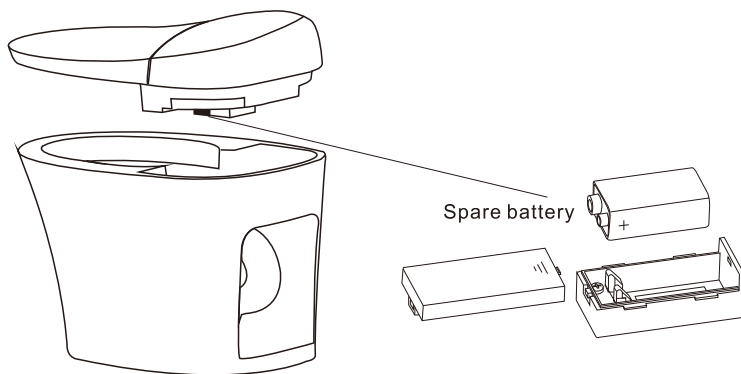

### ※ Notice

1. The spare battery must use 9V alkaline battery, Do not use carbon or other battery.
2. If the battery is low or not installed, it will cause the flushing to stop normally, and flushing even if power off function will be abnormal.
3. We recommended to check and replace the spare battery every 2 years.
4. Please replace the used batteries and recycle them properly.

# Appendix







## ◆ Product specification ◆

|                        |                      |  |   |
|------------------------|----------------------|--|---|
| Ambient temp range     |                      | 4°C-40°C   |   |
| Inlet water temp range |                      | 5°C-35°C   |   |
| Rated voltage          |                      | 120V~ 60Hz   | (Under the condition of 5°C inlet water temp, maximum level of outlet water temp and strength)<br><br>(Inlet water temp: 15°C ±0.5°C) |
| Max power              |                      | 8W   |   |
| Rated power            |                      | 8W   |   |
| Power cord length      |                      | 150mm  |   |
| Cleansing device       | Water pressure range | 0. 14MPa-0. 75MPa(Flow volume is no less than 18L/min) |   |
|                        | Rear wash            | 0.4-0.6 L/min(water pressure ≥0. 15MPa)                |   |
|                        | Front wash           | 0.4-0.65 L/min(water pressure ≥0. 15MPa)               |   |

## ◆ Packing list ◆

Dear user

Please check whether the products are complete after you open the box of toilet. Product packaging box containing the items are:

- 1 Smart toilet 
- 1 Manual 
- 1 Spanner 
- 1 Angle valve (15/16" adapter, 1/2" adapter) 
- 1 9V alkaline battery (6LR61) 
- 1 Wax ring 
- 1 Floor flange (with 1 bag installation bolt) 

## Warning

1. This appliance is not intended for use by persons (including children) with reduced physical, sensory or mental capabilities, or lack of experience and knowledge, unless they have been given supervision or instruction concerning use of the appliance by a person responsible for their safety.
2. Children should be supervised to ensure that they do not play with the appliance.
3. If the supply cord is damaged, it must be replaced by the manufacturer, its service agent or similarly qualified persons in order to avoid a hazard.







