



Quick start guide

CL2940

Big button/big display telephone
with speakerphone/caller ID/
call waiting



Introduction

This quick start guide provides you with basic installation and use instructions. A limited set of features are described in abbreviated form.

Please refer to the complete online user's manual for a full set of installation and operation instructions at www.telephones.att.com/manuals.

Before using this AT&T product, please read **Important safety information** on page 25 of this quick start guide.

Table of content

Parts checklist	1	Dial a directory entry	13
Quick reference guide	2	Edit a directory entry	14
Battery installation	4	Delete a directory entry	14
Telephone installation	6	Speed dial memory	15
Menu setup	7	Store a speed dial number	15
Menu operation	7	Dial a speed dial number	16
Feature summary	7	Caller ID	17
Telephone settings	8	About caller ID	17
Set date and time	8	Call log	17
Ringer volume	8	Missed call indicator	17
Telephone operation	9	Review the call log	17
Make a call	9	Dial a call log entry	18
Answer a call	9	Store a call log entry to the	
End a call	9	directory	18
Switching between handset and		Delete call log	19
speakerphone	9	Troubleshooting	20
Handset volume	9	General product care	24
Speakerphone volume	9	Important safety information	25
Chain dialing	10	Safety information	25
Last number redial	11	FCC and ACTA information	26
Directory	12	Part 15 of FCC rules	27
Directory memory capacity	12	Technical specifications	27
Store a directory entry	12	Limited warranty	28
Review directory entries	13		

Parts checklist

Your telephone package contains the following items. Save your sales receipt and original packaging in the event warranty service is necessary.



Handset



Telephone base

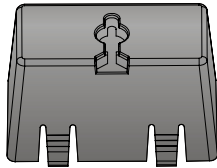

Mounting bracket



Coiled handset cord



Telephone line cord

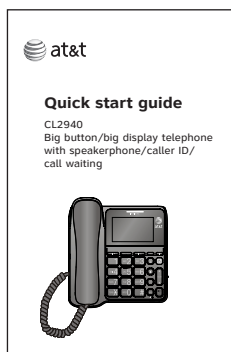

Quick start guide

Quick reference guide

MENU/SELECT

Press to enter the main menu.

While using the menu, press to accept the current setting, and move to the next menu option.

While reviewing the call history, press to store the displayed name and number in the directory.

While reviewing the directory, press to edit the displayed entry.

CID▼

Press to review the call log.

While using the menu, press to scroll through the settings.

While reviewing the directory, speed dial or call log, press to scroll down.

While entering names and numbers, press to move the cursor to the left.

DELETE X

When the telephone is idle, press and hold to clear the call history.

While reviewing an entry stored in the speed dial memory, directory, redial or call log, press to delete.

#

Press repeatedly to show other dialing options while reviewing a call log entry.

MUTE

During a call, press to mute the handset or speakerphone. Press again to resume your conversation.

DIR▲

Press to enter the directory.

While using the menu, press to scroll through the settings.

While reviewing directory, speed dial or call log, press to scroll up.

While entering names and numbers, press to move the cursor to the right.

Tilt display

Adjust the viewing angle to reach maximum visibility.

CANCEL

Press to cancel an operation.

Press to return to the previous menu.

Press and hold to return to idle mode.

When the telephone is idle, press and hold to clear the missed call indicator.

SPEED DIAL

Press to access the speed dial memory.

Press to store a call log entry in a speed dial memory location.

FLASH

During a call, press to answer an incoming call if you subscribe to a call waiting service provided by your telephone service provider.



Quick reference guide

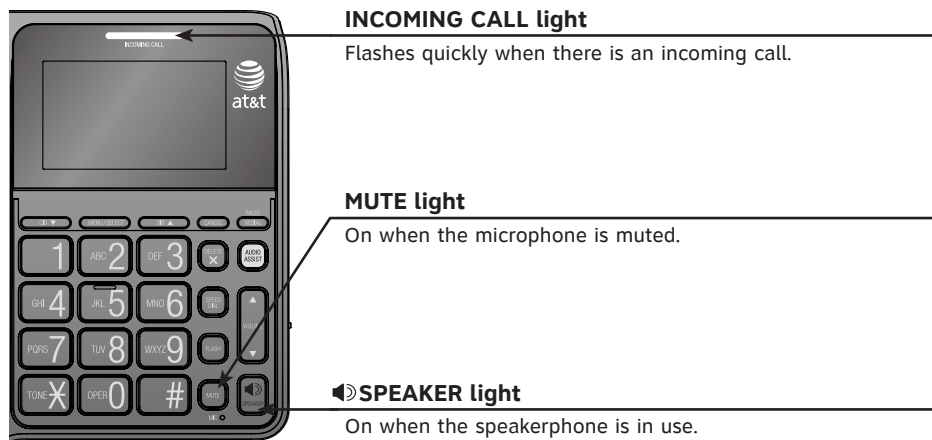
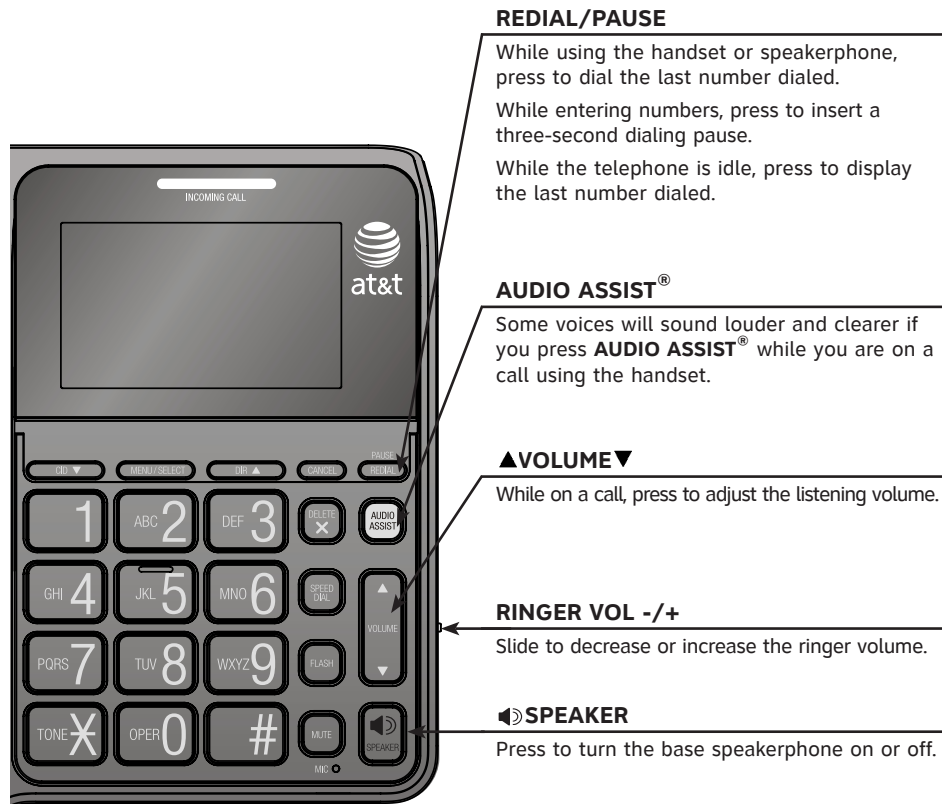

Audio Assist® is a registered trademark of Advanced American Telephones.

Battery installation

Before using the telephone, you should install four good AA alkaline batteries (not included) to provide memory backup and enable the use of some features. The four AA batteries are required for the following features to work: speakerphone, mute, flash, caller ID, display, menu, directory, redial, clock, Audio Assist® and the **INCOMING CALL** light.

If you unplug the telephone from the telephone wall jack, and good batteries are not installed, the following information will be lost: call log history, directory entries, speed dial entries, and all settings in the feature menu. We recommend that you initially install new batteries and change the batteries soon after the low battery icon  appears.

 **CAUTION:** Always unplug the telephone line cord before installing new batteries.

1. Press the large tabs on the battery compartment cover as the arrows indicated below to open the battery compartment cover.

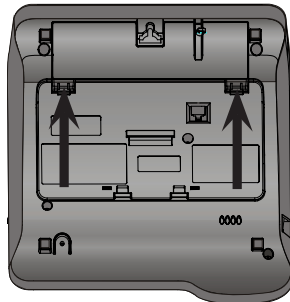

2. Detach the battery compartment cover from the telephone base.

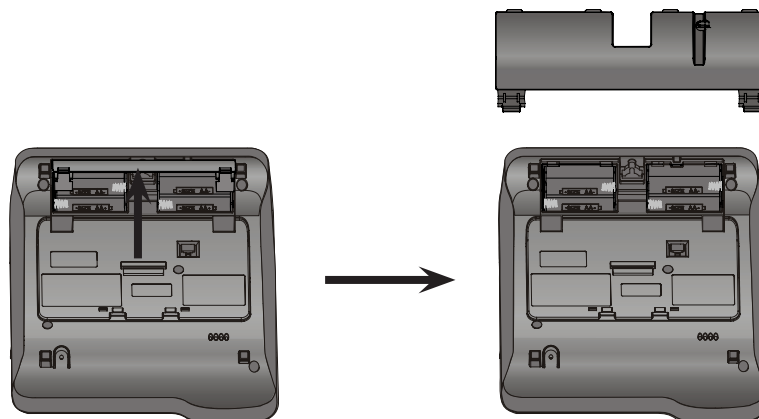

Battery installation

3. Insert four new AA alkaline batteries (not provided) into the battery compartment, following the polarity markings.

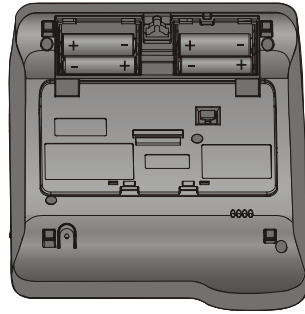

4. Insert the small tabs on the battery compartment cover into the slots on the battery compartment at the telephone base. Then press down on the battery compartment cover as the arrows indicated until it clicks into place.

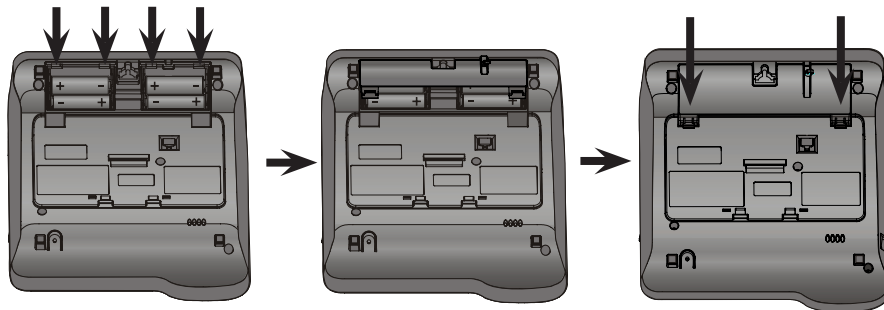

If no batteries are installed or the batteries fail, you can make or answer calls using only the handset.

iNOTES:

- Use disposable AA alkaline batteries only. Do not use rechargeable batteries.
- If you do not use the telephone for a long time, disconnect and remove the batteries from the telephone to prevent possible leakage.
- After replacing the batteries, you need to reset the date and time. For instructions, see **Set date and time** on page 8.
- If no batteries are installed, you can only make or answer calls using the handset. After then, you can press **SPEAKER** to switch to the speakerphone.

Telephone installation

Install the telephone base as shown below. If you subscribe to high-speed Internet service (DSL - digital subscriber line) through your telephone line, you must install a DSL filter between the telephone line cord and the telephone wall jack. The filter prevents noise and caller ID problems caused by DSL interference. Please contact your DSL service provider for more information about DSL filters.

If you want to mount your telephone on a wall, refer to **Installation options** in the online user's manual for details.

1. Plug one end of the coiled handset cord into the handset jack on the left side of the telephone base. Plug the other end into the handset and hang up.

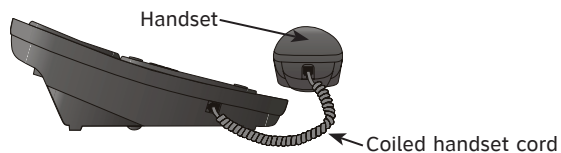

2. Plug one end of the telephone line cord into the **TEL LINE** jack on the back of the telephone base. Plug the other end of the telephone line cord into a telephone wall jack.

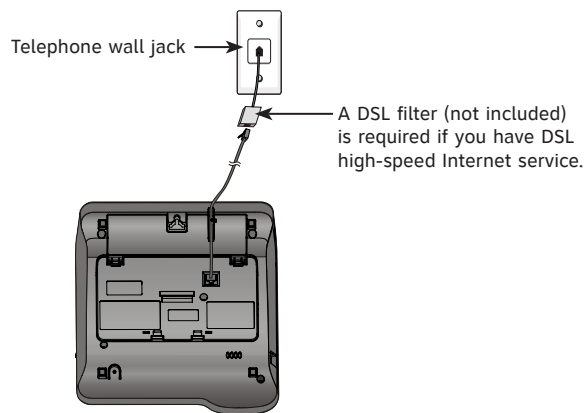

3. Lift the handset or press **SPEAKER** to check for a dial tone.
4. Adjust the angle of the tilt display to reach maximum visibility.

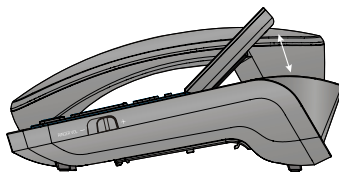

Menu setup

Menu operation

Use the menu to change the telephone settings.

1. Press **MENU/SELECT** repeatedly until the screen displays the desired feature.
2. Press **CID**▼ or **DIR**▲ until the screen displays the desired setting.
3. Press **MENU/SELECT** to save your selection and move to the next feature. The telephone returns to idle mode after 15 seconds, or you can press **CANCEL** to exit programming immediately.



Feature summary

Default settings are indicated by * in the following list.

Feature/options	Function
DATE/TIME 1/01 12:00 AM	Set the date and time. Use the dialing keys to edit. Use # (pound key) to select AM or PM .
CONTRAST 1, 2*, 3, 4	Adjust screen brightness to a comfortable level, from 1 (the lightest) to 4 (the darkest).
DIAL MODE TOUCH TONE* PULSE	Set the telephone to be tone (touch-tone) or pulse (dial pulse) dialing.
LANGUAGE ENGLISH* ESPANOL FRANCAIS	Set the screen display language.
HOME AREA CODE HAC- _ _ _	Set your home area code if you dial only seven digits for local calls.
LOCAL AREA CODE LAC 1- _ _ _ LAC 2- _ _ _ LAC 3- _ _ _ LAC 4- _ _ _	Program up to four local area codes that do not require dialing a 1 before them.

Telephone settings

The following are some common features you may want to set before this telephone. Refer to the online user's manual complete feature instructions.

Set date and time

When the telephone is idle, the screen shows the date and time. If you subscribe to caller ID service, the day, month and time are set automatically with each incoming call. You may also set the date and time manually.

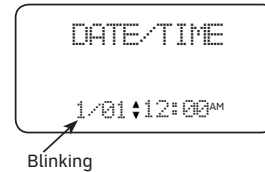

1. Press **MENU/SELECT**. The screen displays **DATE/TIME** and **USE # FOR AM/PM** alternatively.
2. Use the dialing keys (**0-9**) to set the blinking digits. Use **#** (pound key) to select between **AM** and **PM**.
3. Press **MENU/SELECT** to save and move on to the next feature.

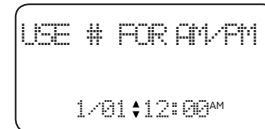

Ringer volume

Adjust the **RINGER VOL -/+** switch at the right side of the telephone base to set the ringer volume to off, low, middle or high. When the ringer is off,  appears on the screen.

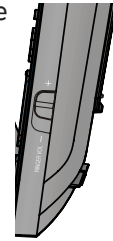

Telephone operation

Make a call

1. Lift the handset then wait for a dial tone.
2. Use the dialing keys to dial a number.

-OR-

1. Press **SPEAKER** then wait for a dial tone.
2. Use the dialing keys to dial a number.

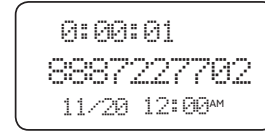

Answer a call

- Lift the handset or press **SPEAKER**.

End a call

Place the handset back in the telephone base, or press **SPEAKER** while using the speakerphone.

Switching between handset and speakerphone

To switch from the handset to speakerphone during a call:

- Press **SPEAKER** then place the handset in the telephone base.

To switch from the speakerphone to handset during a call:

- Lift the handset.



Handset volume

During a call, press **VOLUME** to adjust the listening volume of the handset.



Speakerphone volume

During a call, press **VOLUME** to adjust the listening volume of the speakerphone.



Telephone operation

Chain dialing

Use this feature to initiate a dialing sequence from the numbers in the directory, speed dial memory locations or call log while you are on a call.

Chain dialing is useful if you need to access numbers other than telephone numbers (such as bank account numbers or access codes) from the directory, speed dial memory locations or call log.

To access the directory while on a call:

1. Press **DIR▲** to enter the directory.
2. Press **CID▼** or **DIR▲** until **REVIEW** is blinking. Press **MENU/SELECT** to show the first entry in the directory.
3. Press **CID▼** or **DIR▲** to scroll, or press the dialing keys to find the desired entry.
4. Press **MENU/SELECT** to dial the displayed number.

To access the speed dial memory while on a call:

1. Press **SPEED DIAL**. The screen shows **ENTER SPDIAL#**.
2. Use the dialing keys to choose the desired entry (**0-9**). The telephone dials the displayed number.

To access the call log while on a call:

1. Press **CID▼** to enter the call log.
2. Press **CID▼** or **DIR▲** to scroll to the desired entry.
3. Press **MENU/SELECT**. The telephone dials the displayed number.

Telephone operation

Last number redial

The telephone stores the last number dialed (up to 24 digits).

To dial the last dialed number:

1. Lift the handset or press **SPEAKER**.
2. Press **REDIAL/PAUSE**. Then the telephone dials the number.

-OR-

1. When the telephone is idle, press **REDIAL/PAUSE** to display the last dialed number.
2. Lift the handset or press **SPEAKER**. Then the telephone dials the displayed number.

To delete the last dialed number:

1. When the telephone is idle, press **REDIAL/PAUSE** to show the last dialed number.
2. Press **DELETE X**. The screen shows **DELETED** and then returns to idle mode.

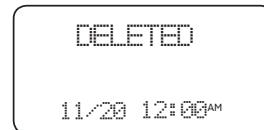
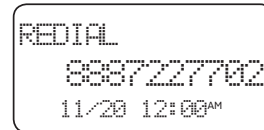
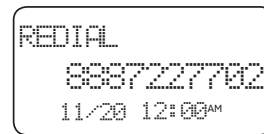

Directory

Directory memory capacity

This telephone has a directory where you can store up to 25 telephone numbers with names. Numbers can be up to 24 digits and names can be up to 15 characters.

Store a directory entry

1. When the telephone is idle, press **DIR▲** to enter the directory menu.
2. Press **CID▼** or **DIR▲** until **STORE** is blinking.
3. Press **MENU/SELECT**.
4. When the screen displays **ENTER NUMBER**, use the dialing keys to enter the telephone number (up to 24 digits).
 - Press **DELETE X** to backspace and erase a digit.
 - Press **CID▼** or **DIR▲** to move the cursor to the left or right.
 - Press **REDIAL/PAUSE** to insert a three-second dialing pause (a **P** appears).
 - Press and hold **REDIAL/PAUSE** to copy the last number dialed.
5. Press **MENU/SELECT**.
6. When the screen displays **ENTER NAME**, use the dialing keys to enter the name (up to 15 characters). Additional key presses produce other characters on that key.
 - Press **DELETE X** to backspace and erase a character.
 - Press **CID▼** or **DIR▲** to move the cursor to the left or right.
7. Press **MENU/SELECT** to save. Then the screen displays **STORED** then returns to the directory menu.



Directory

Review directory entries

1. When the telephone is idle, press **DIR▲** to enter the directory menu.
2. Press **CID▼** or **DIR▲** until **REVIEW** is blinking.
3. Press **MENU/SELECT** to display the first directory entry.
4. Press a dialing key to start a name search. The directory shows the first name beginning with the first letter associated with the dialing key. If there is no entry beginning with the associated letter, the screen will display **NO NAME FOUND**.



REVIEW STORE
↕

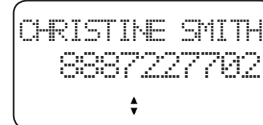

CHRISTINE SMITH
8887227702
↕

-OR-

Press **CID▼** or **DIR▲** to scroll to the desired directory entry.

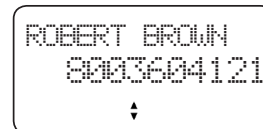

ROBERT BROWN
8003604121
↕

Dial a directory entry

1. Search for the desired directory entry (see **Review directory entries** above).
2. When the desired entry displays, lift the handset or press **◀SPEAKER** to dial.

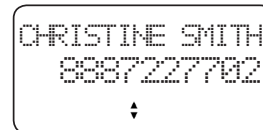

CHRISTINE SMITH
8887227702
↕

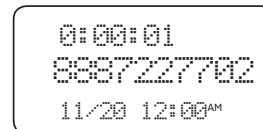

0:00:01
8887227702
11/20 12:00AM

Directory

Edit a directory entry

1. Search for the entry you want to edit (see **Review directory entries** on the previous page).
2. Press **MENU/SELECT**. If you do not want to modify the name, skip to Step 4.
3. When the screen displays the name of the entry, use the dialing keys to edit. Additional key presses produce other characters on that key.
 - Press **DELETE X** to backspace and erase a character.
 - Press **CID▼** or **DIR▲** to move the cursor to the left or right.
4. Press **MENU/SELECT**.
5. When the screen displays **ENTER NUMBER**, use the dialing keys to edit.
 - Press **DELETE X** to backspace and erase a digit.
 - Press **CID▼** or **DIR▲** to move the cursor to the left or right.
 - Press **REDIAL/PAUSE** to insert a three-second dialing pause (a **P** appears).
 - Press and hold **REDIAL/PAUSE** to copy the last number dialed.
6. Press **MENU/SELECT** to save the entry. The screen shows **STORED** and then the modified directory entry.

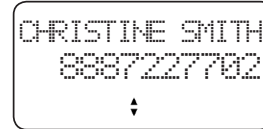

CHRISTINE SMITH
8887227702
↓

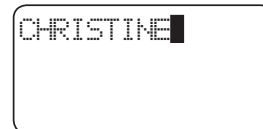

CHRISTINE

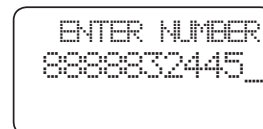

ENTER NUMBER
8888832445_

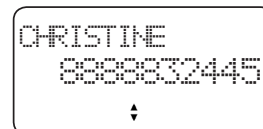

CHRISTINE
8888832445
↓

Delete a directory entry

1. Search for the entry you want to delete (see **Review directory entries** on the previous page).
2. Press **DELETE X** to delete the displayed entry. Then the screen displays **DELETE ENTRY ?**
3. Press **MENU/SELECT**. The screen displays **DELETED** and then the next directory entry, if any.

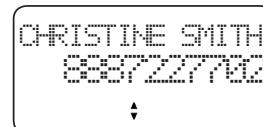

CHRISTINE SMITH
8887227702
↓

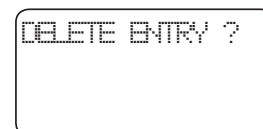

DELETE ENTRY ?
↓

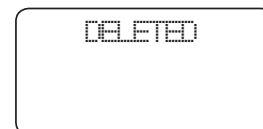

DELETED

Speed dial memory

This telephone has 10 speed dial memory locations where you can store telephone numbers you wish to dial using fewer keys than usual.

Each speed dial memory location can store a telephone number with up to 24 digits.

Store a speed dial number

1. When the telephone is idle, press **SPEED DIAL**. The screen displays **SPEED DIAL #1**.

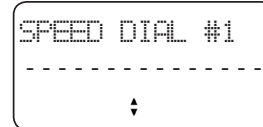

2. Press **CID**▼ or **DIR**▲ to choose an empty speed dial location (**0-9**).

-OR-

Use the dialing keys (**0-9**) to enter the desired speed dial location.

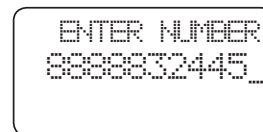

3. Press **MENU/SELECT**.

4. When the screen displays **ENTER NUMBER**, use the dialing keys to enter a telephone number (up to 24 digits).



- Press **DELETE X** to backspace and erase a digit.
- Press **CID**▼ or **DIR**▲ to move the cursor to the left or right.
- Press **REDIAL/PAUSE** to insert a three-second dialing pause (a **P** appears).
- Press and hold **REDIAL/PAUSE** to copy the last number dialed.

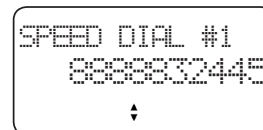

5. Press **MENU/SELECT**. The screen displays **STORED** and then the speed dial number stored.

Speed dial memory

Dial a speed dial number

1. Lift the handset or press **SPEAKER**.
2. Press **SPEED DIAL**. The screen displays **ENTER SPDIAL #**.
3. Use the dialing keys (**0-9**) to enter the desired speed dial location. Then the telephone dials the corresponding speed dial number.

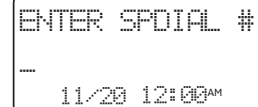

ENTER SPDIAL #

11/20 12:00AM

-OR-

1. When the telephone is idle, press **SPEED DIAL**.
2. Press **CID** or **DIR** to choose the desired speed dial memory location (**0-9**).

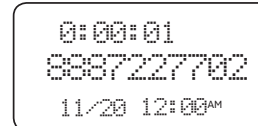

0:00:01
8887227702
11/20 12:00AM

-OR-

Use the dialing keys (**0-9**) to enter the desired speed dial location.

3. When the screen displays the desired entry, lift the handset or press **SPEAKER**. The telephone dials the displayed number.

Caller ID

About caller ID

This product supports caller ID services offered by most telephone service providers. Caller ID allows you to see the name, number, date and time of calls.

The available caller ID information will appear after the first or second ring.

Call log

The call log stores 65 entries.

If you answer a call before the caller ID information displays, it will not be saved in the call log.

Missed call indicator

When the telephone is idle, the screen shows the number of missed calls that have not been reviewed.

Each time you review a call log entry marked **NEW**, the number of missed calls decreases by one.

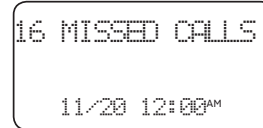

Review the call log

1. When the telephone is idle, press **CID**▼ to enter the call log.
2. Press **CID**▼ or **DIR**▲ to scroll through the entries.

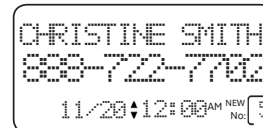

Caller ID

Dial a call log entry

1. When the telephone is idle, press **CID**▼ to enter the call log.
2. Press **CID**▼ or **DIR**▲ to scroll to the desired call log entry.
 - Press **#** (pound key) repeatedly to show different dialing options.
3. When the call log entry is in the correct dialing format, lift the handset or press **▶SPEAKER** to dial the displayed number.

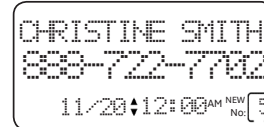

CHRISTINE SMITH
888-722-7702
11/28 12:00 AM ^{NEW}
No. 5

Press #

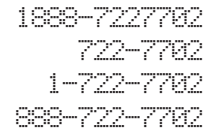

1888-7227702
722-7702
1-722-7702
888-722-7702

Store a call log entry to the directory

1. When the telephone is idle, press **CID**▼ to enter the call log.
2. Press **CID**▼ or **DIR**▲ to scroll to the desired call log entry.
3. Press **MENU/SELECT**. Use the dialing keys to edit the name, if necessary.
4. Press **MENU/SELECT**. Then the screen displays **SAVED TO DIR**.

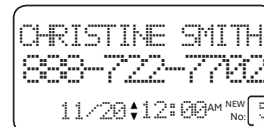

CHRISTINE SMITH
888-722-7702
11/28 12:00 AM ^{NEW}
No. 5



SAVED TO DIR

Caller ID

Delete call log

You cannot retrieve any entries after you have deleted them.

To delete a call log entry:

1. When the telephone is idle, press **CID▼** to enter the call log.
2. Press **CID▼** or **DIR▲** to scroll to the desired call log entry.
3. Press **DELETE X**. The screen shows **DELETE ENTRY ?**
4. Press **MENU/SELECT** to delete the displayed entry. The screen shows **DELETED** and then the next call log entry (if any).

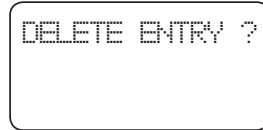
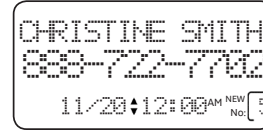

To delete all call log entries:

Use the following steps to delete all call history entries.

1. When the telephone is idle, press and hold **DELETE X**. The screen shows **CLEAR CALL LOG?**
2. Press **MENU/SELECT** within three seconds to confirm and delete all records from the call history. The screen shows **DELETED** and then returns to idle mode.

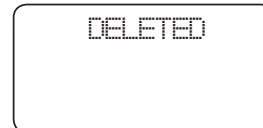
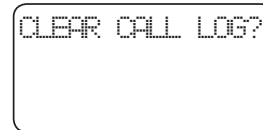
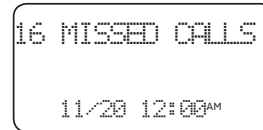

Troubleshooting

If you have difficulty with your telephone, please try the suggestions below. For customer service, or purchase of accessories or replacement parts, visit our website at **www.telephones.att.com**, or call **1 (800) 222-3111**. In Canada, dial **1 (866) 288-4268**.

My telephone does not work at all.

- Unplug the batteries and telephone line cord. Wait for approximately 15 seconds, then plug them in again. Allow up to one minute for the telephone to synchronize.

There is no dial tone.

- Try the suggestion above.
- The telephone line cord may be defective. Try installing a new telephone line cord.
- Make sure the coiled handset cord is securely installed between the handset and the telephone base.
- Disconnect the telephone base from the telephone jack and connect a different telephone. If there is no dial tone on that telephone either, the problem is in your wiring or telephone service. Contact your telephone service provider (charges may apply).

I cannot dial out.

- Try all suggestions above.
- Make sure there is a dial tone before dialing. It is normal if the telephone takes a second or two before producing a dial tone. Wait an extra second before dialing.
- Check that all the telephones connected to the same telephone line are hung up.
- Make sure to set the **DIAL MODE** to the correct setting (pulse dialing or tone dialing) for the service in your area (see **Feature summary** on page 7).
- If any of your other telephones are having the same problem, the problem is in the wiring or telephone service. Contact your telephone service provider (charges may apply).
- If you are using the speakerphone, eliminate any background noise. Noise from a television, radio, or other appliances might cause the telephone to not dial out properly. If you cannot eliminate the background noise, first try muting the telephone before dialing, or dialing from another room in your home with less background noise.

Troubleshooting

The telephone does not ring when there is an incoming call.

- Make sure the ringer is on (see **Ringer volume** on page 8).
- Make sure the telephone line cord is plugged in properly (see **Telephone installation** on page 6).
- There may be too many extension telephones on the telephone line to allow all of them to ring simultaneously. Try unplugging one telephone at a time until the telephones start ringing.
- Test a working telephone at the same telephone jack. If another telephone has the same problem, the problem is in the telephone jack. Contact your telephone service provider (charges may apply).
- The telephone line cord may be defective. Try installing a new telephone line cord.

My calls fade out or cut in and out when I am using the telephone.

- If you are using the handset when this problem occurs, try unplugging the coiled handset cord and firmly plugging it in the handset and telephone base again.
- If you are using the speakerphone when this problem occurs, eliminate any background noise. Noise from the television, radio, or other appliances may cause the speakerphone to cut in and out. Try pressing **MUTE** when you are not speaking to eliminate the background noise.
- Disconnect the telephone base from the telephone wall jack and plug in another corded telephone. If calls are still not clear, the problem is probably in the wiring or telephone service. Contact your telephone service provider (charges may apply).
- If you subscribe to high-speed Internet service (DSL - digital subscriber line) through your telephone line, you must install a DSL filter between the telephone line cord and the telephone wall jack (see **Telephone installation** on page 6). The filter prevents noise and caller ID problems caused by DSL interference. Please contact your DSL service provider for more information about DSL filters.

I hear other calls when using the telephone.

- Disconnect the telephone base from the telephone wall jack. Plug in a different telephone. If you still hear other calls, the problem is probably in the wiring or telephone service. Contact your telephone service provider (charges may apply).

Troubleshooting

appears on the screen.

- The batteries need to be replaced. Replace four new alkaline AA batteries.

Display screen is blank.

- Make sure alkaline batteries with enough charge are installed.

Operation during a power failure.

- This telephone operates during a power failure if a telephone line cord is installed between the telephone wall jack and the telephone base. You are able to answer calls with the handset, and make calls using the dialing keys. No other features work unless batteries are installed. All settings in menu options are retained during a power failure if a telephone line cord is installed between the telephone wall jack and the telephone base.
- If you neither install batteries nor a telephone line, after a few minutes, the telephone clears the directory, call log history, speed dial memory, and the last number dialed memory. At the same time, all settings in menu options change back to the default settings.

My caller ID features are not working properly.

- Caller ID is a subscription service. You must subscribe to this service from your telephone service provider for this feature to work on your telephone.
- The caller may not be calling from an area that supports caller ID.
- Both your and the caller's telephone service providers must use equipment compatible with caller ID service.
- If you subscribe to high-speed Internet service (DSL - digital subscriber line) through your telephone line, you must install a DSL filter between the telephone line cord and the telephone wall jack (see **Telephone installation** on page 6). The filter prevents noise and caller ID problems caused by DSL interference. Please contact your DSL service provider for more information about DSL filters.
- Make sure the area codes are set correctly.
- Reset the telephone (see **Common cure for electronic equipment** on page 23).

Troubleshooting

The telephone does not receive caller ID or the telephone does not display caller ID during call waiting.

- Make sure you subscribe to caller ID with call waiting features provided by the telephone service provider.
- The caller may not be calling from an area that supports caller ID.
- Both your and the caller's telephone service providers must use equipment compatible with caller ID service.

I subscribe to a nontraditional telephone service that uses my computer to establish connections, and my telephone doesn't work.

- Make sure your computer is powered on.
- Make sure your Internet connection is working properly.
- Make sure that the software is installed and running for your nontraditional telephone service.
- Make sure to plug your USB telephone adapter into a dedicated USB port on your computer. Do not plug into a multiple port USB hub (USB splitter) that is not powered.
- In a few rare instances, the USB port on your computer may not have enough power. In these instances, try using a USB hub with its own external power supply.
- If you are using a firewall, it may prevent access to your nontraditional telephone service provider. Contact your service provider for more information.

Common cure for electronic equipment:

If the telephone is not responding normally, try resetting the telephone. Do the following in the order listed:

1. Disconnect the telephone line cord from the telephone base.
2. Remove the batteries.
3. Wait a few minutes before connecting the telephone line cord to the telephone base.
4. Replace the batteries.
5. Wait for the telephone to synchronize its connection. This may take up to one minute.

General product care

To keep your telephone working well and looking good, follow these guidelines:

- Avoid putting it near heating appliances and devices that generate electrical noise (for example, motors or fluorescent lamps).
- DO NOT expose it to direct sunlight or moisture.
- Avoid dropping the telephone or treating it roughly.
- Clean with a soft cloth.
- Never use a strong cleaning agent or abrasive powder because this can damage the finish.
- Retain the original packaging in case you need to ship it at a later date.

Important safety information



This symbol is to alert you to important operating or servicing instructions that may appear in this quick start guide. Always follow basic safety precautions when using this product to reduce the risk of injury, fire, or electric shock.

Safety information

- **Read and understand all instructions in this quick start guide. Observe all markings on the product.**
- **Avoid using a telephone during a thunderstorm.** There might be a slight chance of electric shock from lightning.
- **Do not use a telephone in the vicinity of a gas leak.** Under certain circumstances, a spark may be created when the adapter is plugged into the power outlet, or when the handset is replaced in its cradle. This is a common event associated with the closing of any electrical circuit. The user should not plug the phone into a power outlet, and should not put a charged handset into the cradle, if the phone is located in an environment containing concentrations of flammable or flame-supporting gases, unless there is adequate ventilation. A spark in such an environment could create a fire or explosion. Such environments might include: medical use of oxygen without adequate ventilation; industrial gases (cleaning solvents; gasoline vapors; etc.); a leak of natural gas; etc.
- **Do not use this product near water, or when you are wet.** For example, do not use it in a wet basement or shower, or next to a swimming pool, bathtub, kitchen sink, or laundry tub. Do not use liquids or aerosol sprays for cleaning. If the product comes in contact with any liquids, unplug any line or power cord immediately. Do not plug the product back in until it has dried thoroughly.
- **Install this product in a protected location** where no one can trip over any line or power cords. Protect cords from damage or abrasion.
- **If this product does not operate normally, read Troubleshooting in this quick start guide on pages 20-23.** If you cannot solve the problem, or if the product is damaged, refer to **Limited warranty** on pages 28-29. Do not open this product except as may be directed in your user's manual. Opening the product or reassembling it incorrectly may expose you to hazardous voltages or other risks.
- **If this product has replaceable batteries, replace batteries only as described on pages 4-5.** Do not burn or puncture batteries—they contain caustic chemicals.
- **If this product has a three-prong (grounding) plug or a polarized plug with one wide prong, it might not fit in outlets that are not polarized.** Do not defeat the purpose of these plugs. If they do not fit in your outlet, the outlet should be replaced by an electrician.

SAVE THESE INSTRUCTIONS

FCC and ACTA information

If this equipment was approved for connection to the telephone network prior to July 23, 2001, it complies with Part 68 of the Federal Communications Commission (FCC) rules. If the equipment was approved after that date, it complies with the Part 68 rules and with the Technical Requirements for Connection of Equipment to the Telephone Network adopted by the Administrative Council for Terminal Attachments (ACTA). We are required to provide you with the following information.

1. Product identifier and REN information

The label on the back or bottom of this equipment contains, among other things, an identifier indicating product approval and the Ringer Equivalence Number (REN). This information must be provided to your telephone service provider upon request. For equipment approved prior to July 23, 2001, the product identifier is preceded by the phrase "FCC Reg No." and the REN is listed separately. For equipment approved after that date, the product identifier is preceded by "US" and a colon (:), and the REN is encoded in the product identifier without a decimal point as the sixth and seventh characters following the colon. For example, the product identifier US:AAAEQ03T123XYZ indicates the REN would be 0.3.

The REN is used to determine how many devices you can connect to your telephone line and still have them ring when you are called. In most, but not all areas, the sum of all RENS should be five (5.0) or less. You might want to contact your telephone service provider for more information.

2. Connection and use with the nationwide telephone network

The plug and jack used to connect this equipment to the premises wiring and the telephone network must comply with the applicable Part 68 rules and technical requirements adopted by ACTA. A compliant telephone cord and modular plug is provided with this product. It is designed to be connected to a compatible modular wall jack that is also compliant. An RJ11 jack should normally be used for connecting to a single line and an RJ14 jack for two lines, see the installation instructions in the user's manual. This equipment may not be used with coin telephone lines or with party lines. If you have specially wired alarm dialing equipment connected to your telephone line, ensure the connection of this equipment does not disable your alarm equipment. If you have questions about what will disable the alarm equipment, consult your telephone service provider or qualified installer.

3. Repair instructions

If this equipment is malfunctioning, it must be unplugged from the modular wall jack until the problem has been corrected. Repairs to this telephone equipment can only be made by the manufacturer or its authorized agents. For repair procedures, follow the instructions outlined under the limited warranty.

4. Rights of the telephone service provider

If this equipment is causing harm to the telephone network, the telephone service provider may temporarily discontinue your telephone service. The telephone service provider is required to notify you before interrupting service. If advance notice is not practical, you will be notified as soon as possible. You will be given the opportunity to correct the problem and the telephone service provider is required to inform you of your right to file a complaint with the FCC. Your telephone service provider may make changes in its facilities, equipment, operation, or procedures that could affect the proper functioning of this product. The telephone service provider is required to notify you if such changes are planned.

5. Hearing aid compatibility

If this product is equipped with a corded or cordless handset, it is hearing aid compatible.

FCC and ACTA information

6. Programming/testing of emergency numbers

If this product has memory dialing locations, you may choose to store police, fire department and emergency medical service telephone numbers in these locations. If you do, please keep three things in mind:

- a. We recommend that you also write the telephone number on the directory card (if applicable), so that you can still dial the emergency number manually if the memory dialing feature doesn't work.
- b. This feature is provided only as a convenience, and the manufacturer assumes no responsibility for customer reliance upon the memory feature.
- c. Testing the emergency telephone numbers you have stored is not recommended. However, if you do make a call to an emergency number:
 - You must remain on the line and briefly explain the reason for the call before hanging up.
 - Programming/testing of emergency numbers should be performed during off-peak hours, such as in the early morning or late evening, when the emergency services tend to be less busy.

Part 15 of FCC rules

Some telephone equipment generates, uses, and can radiate radio-frequency energy and, if not installed and used properly, may cause interference to radio and television reception. This product has been tested and found to meet the standards for a Class B digital device, as specified in Part 15 of the FCC rules.

These specifications are designed to provide reasonable protection against such interference in a residential installation. However, there is no guarantee that interference will not occur in a particular installation.

If this product causes interference to radio, VCR or television reception when it is in use, you might correct the interference with any one or all of these measures:

- Where it can be done safely, reorient the receiving radio, VCR or television antenna.
- To the extent possible, relocate the radio, VCR, television or other receiver with respect to the telephone equipment.
- If this telephone product runs on AC power, plug your product into an AC outlet that's not on the same circuit as one used by your radio, VCR or television.
- Consult a dealer or an experienced radio/TV technician for help.

Modifications to this product, not expressly approved by the manufacturer, could void the user's authority to operate the equipment.

Technical specifications

Operating temperature	32°F — 122°F 0°C — 50°C
-----------------------	----------------------------

REN	1.0B
-----	------

Limited warranty

The AT&T brand is used under license - any repair, replacement or warranty service, and all questions about this product should be directed to: In the United States of America, call **1 (800) 222-3111** or visit **www.telephones.att.com**. In Canada, call **1 (866) 288-4268**.

1. What does this limited warranty cover?

The manufacturer of this AT&T branded product warrants to the holder of a valid proof of purchase ("CONSUMER" or "you") that the product and all accessories provided in the sales package ("PRODUCT") are free from defects in material and workmanship, pursuant to the following terms and conditions, when installed and used normally and in accordance with the PRODUCT operating instructions. This limited warranty extends only to the CONSUMER for products purchased and used in the United States of America and Canada.

2. What will be done if the PRODUCT is not free from defects in materials and workmanship during the limited warranty period ("materially defective PRODUCT")?

During the limited warranty period, the manufacturer's authorized service representative repairs or replaces at the manufacturer's option, without charge, a materially defective PRODUCT. If the manufacturer repairs the PRODUCT, they may use new or refurbished replacement parts. If the manufacturer chooses to replace the PRODUCT, they may replace it with a new or refurbished PRODUCT of the same or similar design. The manufacturer retains the defective parts, modules, or equipment. Repair or replacement of the PRODUCT, at the manufacturer's option, is your exclusive remedy. The manufacturer returns the repaired or replacement products to you in working condition. You should expect the repair or replacement to take approximately 30 days.

3. How long is the limited warranty period?

The limited warranty period for the PRODUCT extends for ONE (1) YEAR from the date of purchase. If the manufacturer repairs or replaces a materially defective PRODUCT under the terms of this limited warranty, this limited warranty also applies to repaired or replacement PRODUCT for a period of either (a) 90 days from the date the repaired or replacement PRODUCT is shipped to you or (b) the time remaining on the original one-year limited warranty; whichever is longer.

4. What is not covered by this limited warranty?

This limited warranty does not cover:

- PRODUCT that has been subjected to misuse, accident, shipping or other physical damage, improper installation, abnormal operation or handling, neglect, inundation, fire, water, or other liquid intrusion; or
- PRODUCT that has been damaged due to repair, alteration, or modification by anyone other than an authorized service representative of the manufacturer; or
- PRODUCT to the extent that the problem experienced is caused by signal conditions, network reliability or cable or antenna systems; or
- PRODUCT to the extent that the problem is caused by use with non-AT&T accessories; or
- PRODUCT whose warranty/quality stickers, PRODUCT serial number plates or electronic serial numbers have been removed, altered or rendered illegible; or
- PRODUCT purchased, used, serviced, or shipped for repair from outside the United States of America or Canada, or used for commercial or institutional purposes (including but not limited to products used for rental purposes); or
- PRODUCT returned without a valid proof of purchase (see item 6 below); or
- Charges for installation or setup, adjustment of customer controls, and installation or repair of systems outside the unit.

Limited warranty

5. How do you get warranty service?

To obtain warranty service in the United States of America, visit

www.telephones.att.com or call **1 (800) 222-3111**. In Canada, please dial **1 (866) 288-4268**.

NOTE: Before calling for service, please review the user's manual. A check of the PRODUCT's controls and features may save you a service call.

Except as provided by applicable law, you assume the risk of loss or damage during transit and transportation and are responsible for delivery or handling charges incurred in the transport of the PRODUCT(s) to the service location. The manufacturer will return repaired or replaced PRODUCT under this limited warranty. Transportation, delivery or handling charges are prepaid. The manufacturer assumes no risk for damage or loss of the PRODUCT in transit. If the PRODUCT failure is not covered by this limited warranty, or proof of purchase does not meet the terms of this limited warranty, the manufacturer notifies you and requests that you authorize the cost of repair prior to any further repair activity. You must pay for the cost of repair and return shipping costs for the repair of products that are not covered by this limited warranty.

6. What must you return with the PRODUCT to get warranty service?

You must:

- a. Return the entire original package and contents including the PRODUCT to the service location along with a description of the malfunction or difficulty; and
- b. Include a "valid proof of purchase" (sales receipt) identifying the PRODUCT purchased (PRODUCT model) and the date of purchase or receipt; and
- c. Provide your name, complete and correct mailing address, and telephone number.

7. Other limitations

This warranty is the complete and exclusive agreement between you and the manufacturer of this AT&T branded PRODUCT. It supersedes all other written or oral communications related to this PRODUCT. The manufacturer provides no other warranties for this PRODUCT. The warranty exclusively describes all of the manufacturer's responsibilities regarding the PRODUCT. There are no other express warranties. No one is authorized to make modifications to this limited warranty and you should not rely on any such modification.

State/Provincial Law Rights: This warranty gives you specific legal rights, and you might also have other rights that vary from state to state or province to province.

Limitations: Implied warranties, including those of fitness for a particular purpose and merchantability (an unwritten warranty that the PRODUCT is fit for ordinary use) are limited to one year from date of purchase. Some states/provinces do not allow limitations on how long an implied warranty lasts, so the above limitation might not apply to you. In no event shall the manufacturer be liable for any indirect, special, incidental, consequential, or similar damages (including, but not limited to lost profits or revenue, inability to use the PRODUCT or other associated equipment, the cost of substitute equipment, and claims by third parties) resulting from the use of this PRODUCT. Some states/provinces do not allow the exclusion or limitation of incidental or consequential damages, so the above limitation or exclusion might not apply to you.

Please retain your original sales receipt as proof of purchase.



www.telephones.att.com

Audio Assist[®] is a registered trademark of Advanced American Telephones.

© 2011 Advanced American Telephones. All Rights Reserved.
AT&T and the AT&T logo are trademarks of AT&T Intellectual Property licensed to
Advanced American Telephones, San Antonio, TX 78219.
Printed in China. Issue 2 AT&T 12/11.