



Quick start guide

ML17939

Two-line corded telephone/
answering system with
caller ID/call waiting



Installation preparation

You must install the power adapter before using the telephone.



See pages 4-5 for easy instructions.

If you subscribe to high speed Internet service (DSL - digital subscriber line) through your telephone line, you must install a DSL filter between each telephone line cord and telephone wall jack (pages 4 and 5). The filter prevents noise and caller ID problems caused by DSL interference. Please contact your DSL service provider for more information about DSL filters.

Your product may be shipped with a protective sticker covering the telephone base display - remove it before use.

For customer service or product information, visit our website at **www.telephones.att.com** or call **1 (800) 222-3111**. In Canada, dial **1 (866) 288-4268**.

Avoid placing the telephone base too close to:

- Communication devices such as television sets, VCRs, or cordless telephones.
- Excessive heat sources.
- Noise sources such as a window with traffic outside, motors, microwave ovens, refrigerators, or fluorescent lighting.
- Excessive dust sources such as a workshop or garage.
- Excessive moisture.
- Extremely low temperature.
- Mechanical vibration or shock such as on top of a washing machine or work bench.

This quick start guide provides basic instructions. For additional installation options and complete instructions that enable you to use all features of this telephone, refer to your AT&T ML17939 Two-line corded telephone/answering system with caller ID/call waiting user's manual.

Optional backup battery installation

Install three AA alkaline batteries (purchased separately) to use this telephone in the event of a power failure. If power fails with working batteries installed, all functions work properly except for the display illumination.

If power fails and no batteries are installed, you can make or answer calls on line 1 using only the handset. Last number redial and speed dialing are also supported, but the screen display will be dimmer than usual.

Install the batteries, as shown below:

1. Press the tab and pull to remove the battery compartment cover. Insert three AA alkaline batteries (purchased separately) following the polarity markings in the battery compartment.

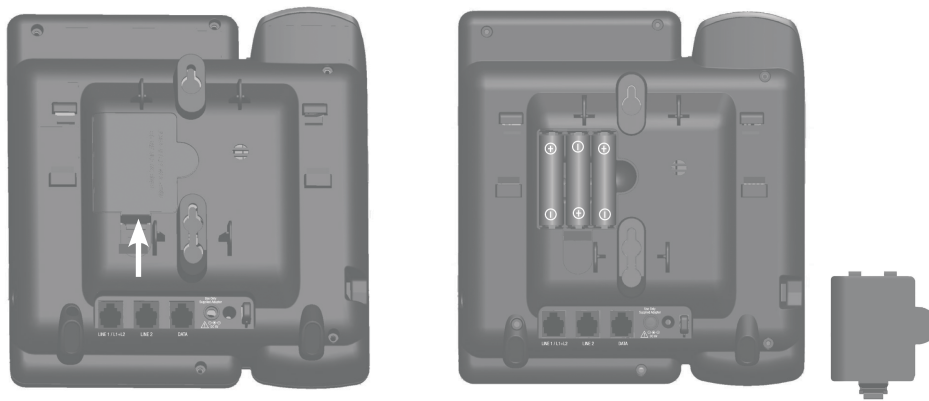

2. Replace the battery compartment cover.

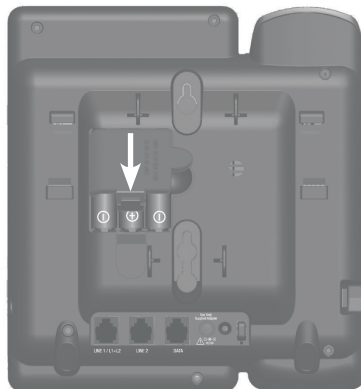

NOTE: If no backup batteries are installed and the power adapter is connected,  appears steady on the screen.

Telephone installation

Telephone base installation

1. Install the mounting bracket for tabletop use.

Option 1: To install your telephone in a low tabletop position, insert the fixed tabs of the mounting bracket into slots (a) and (b). Press the flexible tabs (A) and (B) into slots (c) and (d) until they click into place.

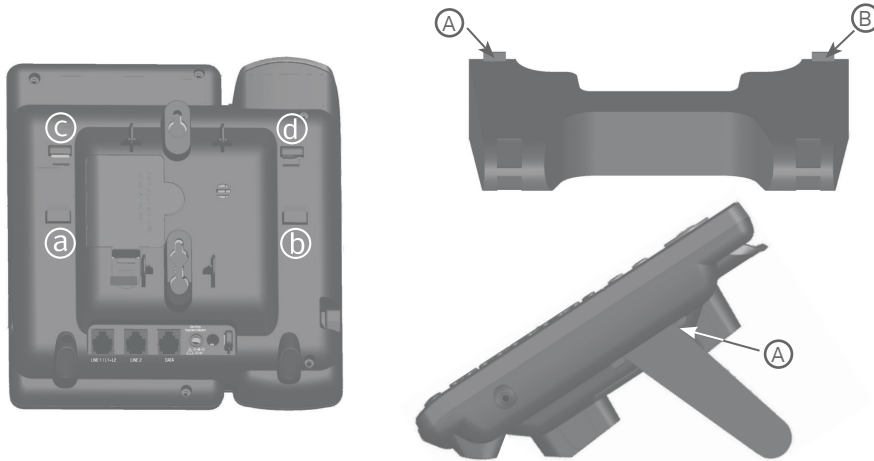

Option 1: Low tabletop position

Option 2: To install your telephone in a high tabletop position, insert the fixed tabs of the mounting bracket into slots (c) and (d). Press the flexible tabs (A) and (B) into slots (a) and (b) until they click into place.

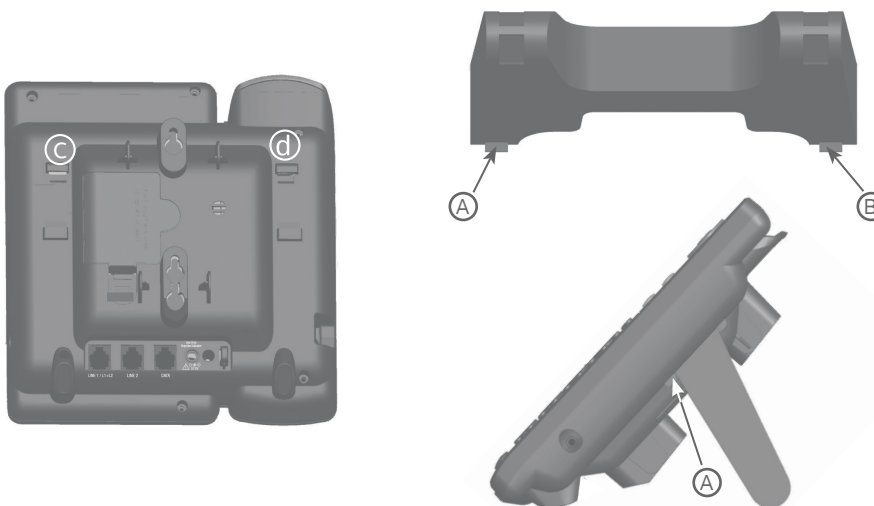

Option 2: High tabletop position

Telephone installation

2. Connect the telephone line cord(s) and the power cord to the telephone base.

If you subscribe to high speed Internet service (DSL - digital subscriber line) through your telephone line, you must install a DSL filter between each telephone line cord and telephone wall jack. The filter prevents noise and caller ID problems caused by DSL interference. Please contact your DSL service provider for more information about DSL filters.

Option 1: If you have a two-line wall jack, install your telephone base, as shown below.

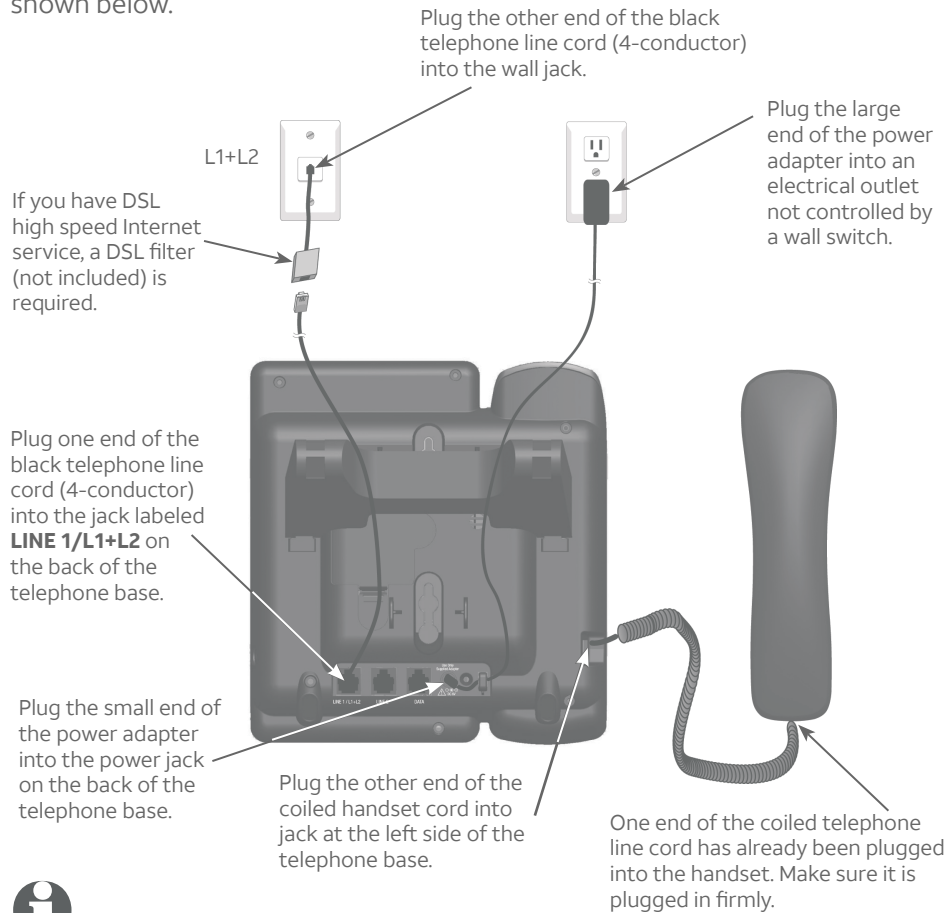

NOTES:

- Use only the power adapter supplied with this product. To order a replacement power adapter, visit our website at www.telephones.att.com, or call **1 (800) 222-3111**. In Canada, dial **1 (866) 288-4268**.
- The power adapter is intended to be correctly oriented in a vertical or floor mount position. The prongs are not designed to hold the plug in place if it is plugged into a ceiling, under-the-table or cabinet outlet.

Telephone installation

Option 2: If you have two one-line wall jacks, install your telephone base, as shown below.

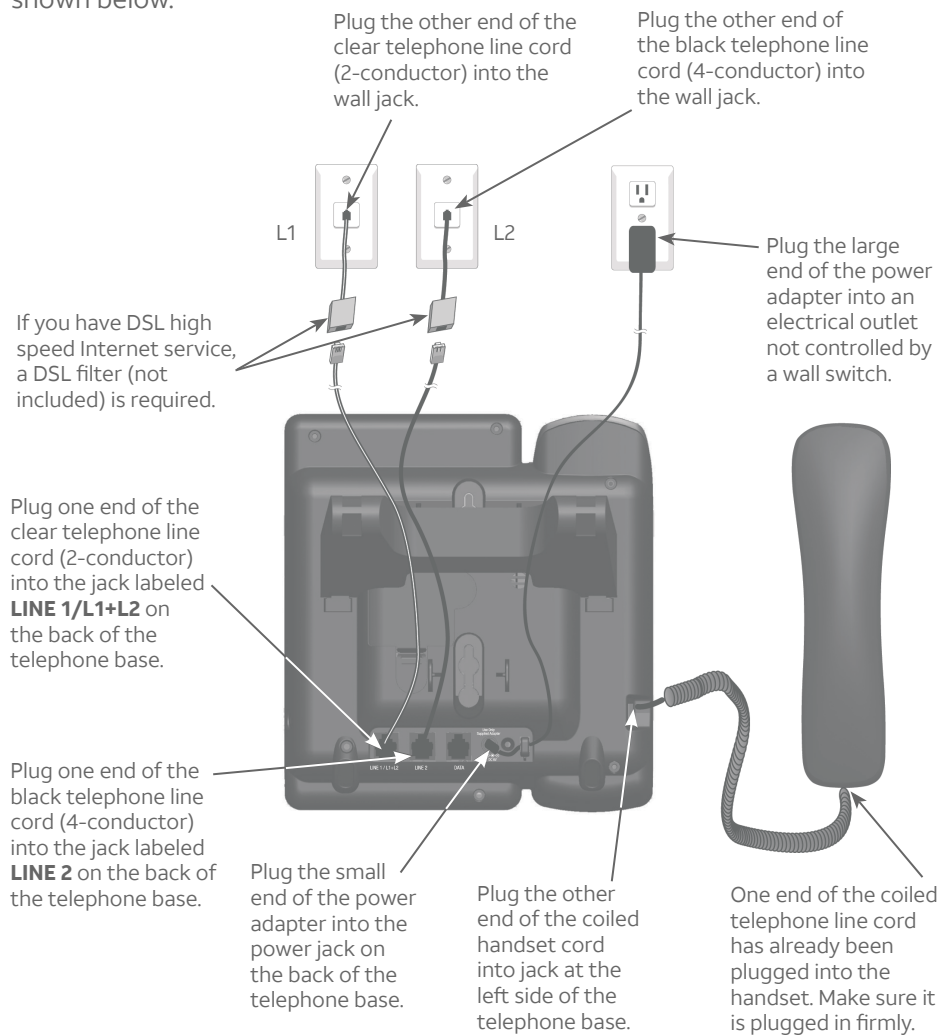

NOTES:

- Use only the power adapter supplied with this product. To order a replacement power adapter, visit our website at www.telephones.att.com, or call **1 (800) 222-3111**. In Canada, dial **1 (866) 288-4268**.
- The power adapter is intended to be correctly oriented in a vertical or floor mount position. The prongs are not designed to hold the plug in place if it is plugged into a ceiling, under-the-table or cabinet outlet.

Quick reference guide

DELETE

Press to delete the displayed directory or call history entry.
 Press to backspace and erase a digit or character.
 During message playback, press to delete the message currently playing.
 When the telephone is idle, press to delete all old messages.

DIR

Press to enter the directory.

MENU

Press to enter the main menu.

CID

Press to display call history information.

CANCEL

Press to cancel an operation and go back to the previous menu.

Press and hold to return to idle mode.

CONF

Press to initiate a three-way conference call.

LINE 1, LINE 2

Press to make or answer a call on the selected line.

ENTER

Press to select a menu item or to save a setting.

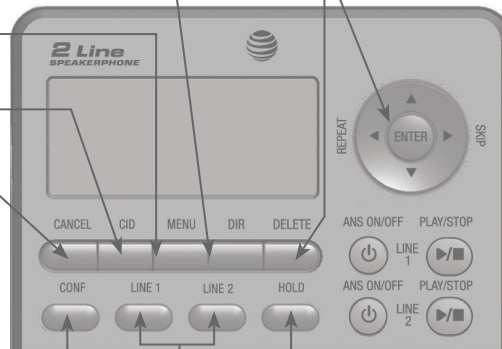

HOLD

Press to place a call on hold.

◀/REPEAT

While playing messages, press to repeat the message, or press twice to hear the previous message.

While entering names or numbers, press to move the cursor to the left.

Press to go back to the previous menu.

⏻/ANS ON/OFF LINE1/LINE2

Press to turn the built-in answering system on or off.

▶/SKIP

Press to skip to the next message.

While entering names or numbers, press to move the cursor to the right.

▲/▼

While in the menu, press to scroll up or down.

While reviewing the directory or call history, press to scroll through entries or press and hold to scroll continuously.

▶/■/PLAY/STOP LINE1/LINE2

Press to start or stop message playback.

Press to stop recording a memo.

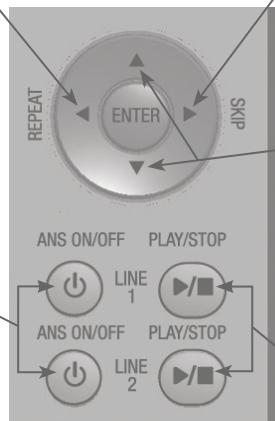

Quick reference guide

FLASH

During a call, press to answer an incoming call when you receive a call waiting alert.

(AUTO) REDIAL

Press to dial the last number dialed when the telephone is off hook.

When the telephone is idle, press to display the last five numbers dialed. You can choose to dial a displayed number or use the auto redial feature.

VOL+

While the telephone is not in use, press to increase the ringer volume for both lines.

During a call, press to increase the listening volume.

During message playback, press to increase the playback volume.

VOL-

While the telephone is not in use, press to decrease the ringer volume for both lines.

During a call, press to decrease the listening volume.

During message playback, press to decrease the playback volume.

HEADSET

Press to activate the headset when a corded headset is connected.

MUTE

During a call, press to mute the microphone.

When a call is ringing, press to mute the ringer.

PAUSE

Press to insert a two-second dialing pause in a number stored in the directory or speed dial memory.

DISP DIAL

Press to dial the number currently displayed.



SPEAKER

Press to turn the base speakerphone on or off.

LOWER

Press to enter the lower locations of the speed dial keys.

Speed dial keys

Press to dial or review a stored speed dial number when the telephone is idle.

Basic operation

The telephone is set to use line 1 by default for making calls. To change the primary line, see **Set the primary line** in the user's manual. When you answer a call, the telephone automatically selects the ringing line.

Making, answering or ending a call

To make a call with the speakerphone:

1. Press **SPEAKER**  to use the primary line.

-OR-

To override automatic line selection, press **SPEAKER** , then press **LINE 1** or **LINE 2**.

-OR-

If you choose **Speakerphone** in **Choose the preferred mode** (see user's manual), press **LINE 1** or **LINE 2** directly to activate the speakerphone.

2. Wait for a dial tone, then dial the telephone number. The screen displays the elapsed time as you talk (in hours, minutes and seconds).
3. Press **SPEAKER**  to hang up.

To make a call with the handset:

1. Lift the handset to use the primary line.

-OR-

To override automatic line selection, lift the handset, then press **LINE 1** or **LINE 2**.

2. Wait for a dial tone, then dial the number.
3. Place the handset on the telephone base to hang up.

To make a call with the corded headset:

Make sure the corded headset is connected to the telephone base (see **Optional headset** in the user's manual).

1. Press **HEADSET** on the telephone base to use the primary line.

-OR-

To override automatic line selection, press **HEADSET**, then press **LINE 1** or **LINE 2**.

-OR-

If you choose **Headset** in **Choose the preferred mode** (see user's manual), press **LINE 1** or **LINE 2** directly to activate the headset.

2. Wait for a dial tone, then dial the number.
3. Press **HEADSET** to hang up.

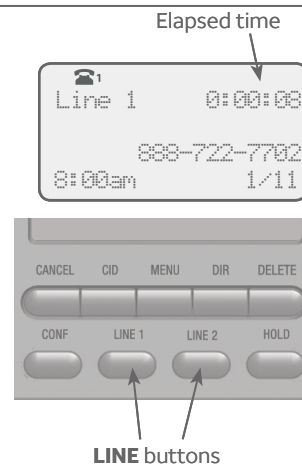

Basic operation

To answer a call:

- Lift the handset, press **SPEAKER**  or **HEADSET**.

-OR-

Press the **LINE** button of the ringing line to answer the call with the preferred mode (see **Choose the preferred mode** in the user's manual).

On hook dialing (predialing)

1. Press the dialing keys to enter a telephone number. Press **DELETE** to make corrections when entering the telephone number.
2. Lift the handset or press **SPEAKER**  or **HEADSET**.

-OR-

To dial the number using your preferred mode (see **Choose the preferred mode** in the user's manual):

- Press **DISP DIAL**.
- Press **LINE 1** or **LINE 2** to override automatic line selection.

Clearspeak® dial-in-base speakerphone

During a call, press **SPEAKER** , then hang up the handset. This allows you to use the telephone hands free and lets more people participate in the conversation.

Turn the answering system on or off

By default, the answering system is on and ready to record messages on each telephone line. When the answering system of the corresponding line is on, the corresponding **📞/ANS ON/OFF** indicator light is on. If you turn the answering system off, the answering system does not answer calls and record incoming messages.

- Press **📞/ANS ON/OFF LINE 1** or **📞/ANS ON/OFF LINE 2** to turn the corresponding answering system on or off. When the answering system is turned on, it announces *"Calls will be answered."* The **📞/ANS ON/OFF LINE 1** or **📞/ANS ON/OFF LINE 2** indicator light turns on. When the answering system is turned off, it announces *"Calls will not be answered."* The **📞/ANS ON/OFF LINE 1** or **📞/ANS ON/OFF LINE 2** indicator light turns off.



NOTE: To turn the answering system on or off in the menu, see the user's manual for instructions.

Basic operation

Message playback

Press ►/■/**PLAY/STOP LINE 1/LINE 2** to listen to messages on the corresponding line.

Options during message playback:

- Press **VOL-** or **VOL+** to adjust the speaker volume.
- Press ►/**SKIP** to skip to the next message.
- Press ◀/**REPEAT** to repeat the message currently playing.
Press ◀/**REPEAT** twice to listen to the previous message.
- Press **DELETE** to delete the current message. The system announces “*Message deleted*” and advances to the next message.
- Press ►/■/**PLAY/STOP** to end the message playback.

Answering system settings

Record outgoing announcements

You can record two announcements for each mailbox (Annc A and Annc B). The default greeting for announcements A and B is *“Hello, please leave a message after the tone.”* You can use this default announcement or replace it with your own. The telephone is preset to answer with the default announcement A. See **Announcement selection** in the user’s manual to change which announcement is played.

To record a new announcement A or B:

1. When the telephone is idle, press **MENU**.
2. Press **▲** or **▼** to scroll to **Answering sys.**
Press **ENTER**.
3. Press **▲** or **▼** to scroll to **Mailbox 1** or **Mailbox 2**.
Press **ENTER**.
4. Press **▲** or **▼** to scroll to **Announcement**.
Press **ENTER**.
5. Press **▲** or **▼** to scroll to **Annc A** or **Annc B**.
Press **ENTER**.
6. Press **▲** or **▼** to scroll to **Record**.
7. Press **ENTER**. The telephone announces, *“Record after the tone. Press **STOP** when you are done.”* After the tone, speak towards the microphone of the telephone base to record an announcement of up to 90 seconds. Announcements shorter than two seconds cannot be recorded. If the memory is full, the system announces, *“Memory is full.”* You must delete some messages before recording.
8. Press **▶/■/PLAY/STOP** of the corresponding line when finished. The answering system automatically plays back the newly recorded announcement.

```
Phone settings
Call settings
▶ Answering sys
Voicemail
```

```
ANSWERING SYS
▶ Mailbox 1
Mailbox 2
```

```
MAILBOX 1
Play messages
▶ Announcement
Delete all old
```

```
ANNOUNCEMENT M1
Config annc
▶ Annc A
Annc B
```

```
Annc A 10.0
Play
▶ Record
Delete
```

```
10.0
Recording
announcement...
```

```
10.0
Announcement
Playback
```

Answering system settings

Call screening

Use this feature to set whether incoming messages are played through the speaker while they are being recorded. **Call screening** is **On** by default.

1. When the telephone is idle, press **MENU**.
2. Press **▲** or **▼** to scroll to **Answering sys.** Press **ENTER**.
3. Press **▲** or **▼** to scroll to **Mailbox 1** or **Mailbox 2** to select the desired line. Press **ENTER**.
4. Press **▲** or **▼** to scroll to **Ans sys setup**. Press **ENTER**.
5. Press **▲** or **▼** to scroll to **Call screening**. Press **ENTER**.
6. Press **▲** or **▼** to select **On** or **Off**.
7. Press **ENTER** to save your selection. The telephone plays a confirmation tone and returns to the previous menu.

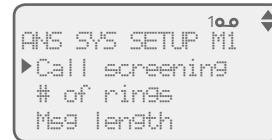



www.telephones.att.com

Clearspeak® is a registered trademark of Advanced American Telephones.

© 2010-2016 Advanced American Telephones. All Rights Reserved.

AT&T and the AT&T logo are trademarks of AT&T Intellectual Property licensed to
Advanced American Telephones, San Antonio, TX 78219.

Printed in China. Issue 7.0 AT&T 12/16.