

Installation Manual for the



⚠ WARNING! ⚠

This equipment is similar to other gate or door equipment and meets or exceeds Underwriters Laboratory Standard 325 (UL 325). However, gate equipment has hazards associated with its use and therefore by installing this product the installer and user accept full responsibility for following and noting the installation and safety instructions. Failure to follow installation and safety instructions can result in hazards developing due to improper assembly. You agree to properly install this product and that if you fail to do so GTO, Inc. shall in no event be liable for direct, indirect, incidental, special or consequential damages or loss of profits whether based in contract tort or any other legal theory during the course of the warranty or at any time thereafter. The installer and/or user agree to assume responsibility for all liability and use of this product releasing GTO, Inc. from any and all liability. If you are not in agreement with this disclaimer or do not feel capable of properly following all installation and safety instructions you may return this product for full replacement value.

READ ALL INSTRUCTIONS CAREFULLY AND COMPLETELY before attempting to install and use this automatic gate opener. This gate opener produces a high level of force. Stay clear of the unit while it is operating and exercise caution at all times.

All automatic gate openers are intended for use on vehicular gates only.

This product meets and exceeds the requirements of UL 325, the standard which regulates gate opener safety, as established and made effective March 1, 2000, by Underwriters Laboratories Inc.



For more information on Mighty Mule's full line of Automatic Gate Openers and Access Controls visit our website at www.mightymule.com

GTO Sales: (800) 543-GATE (4283) or (850) 575-0176 • Fax (850) 575-8912 or
GTO Technical Service (800) 543-1236 or (850) 575-4144

For 24 hr/day, 7 day/week Technical Service visit <http://support.gtoinc.com/support/troubleshooter.aspx>

R352INST
rev - 07/13/09

The Mighty Mule® Gate Opener is intended for use with vehicular swing gates. The opener can be used in Class I, Class II and Class III applications.

VEHICULAR GATE OPENER CLASS CATEGORIES

Residential Vehicular Gate Opener-Class I: A vehicular gate opener (or system) intended for use in a home of one-to-four single family dwelling, or a garage or parking area associated therewith.

Commercial/General Access Vehicular Gate Opener-Class II: A vehicular gate opener (or system) intended for use in a commercial location or building such as a multifamily housing unit (five or more single family units), hotel, garages, retail store, or other building servicing the general public.

Industrial/Limited Access Vehicular Gate Opener-Class III: A vehicular gate opener (or system) intended for use in an industrial location or building such as a factory or loading dock area or other locations not intended to service the general public.

Conversion Chart

<i>Converting Metric Units to English Equivalents</i>			
When You Know	Multiply By	To Find	Symbol
centimeters	0.3937	inches	in. (or ")
meters	3.2808	feet	ft. (or')
kilograms	2.2046	pounds	lb. (or #)
<i>Converting English Units to Metric Equivalents</i>			
When You Know	Multiply By	To Find	Symbol
inches	2.5400	centimeters	cm
feet	0.3048	meters	m
pounds	0.4535	kilograms	kg
<i>Converting Temperature</i>			
deg. Celsius	$(^{\circ}\text{C} \times 1.8) + 32$	deg. Fahrenheit	$^{\circ}\text{F}$
deg. Fahrenheit	$(^{\circ}\text{F} - 32) \div 1.8$	deg. Celsius	$^{\circ}\text{C}$

FOR YOUR RECORDS

Please record the product serial number (located on the rear of opener arm), and the date and place of purchase in the spaces provided below. Refer to this information when calling GTO for service or assistance with your automatic gate opener.

Serial Number _____ **Date of Purchase** _____

Place of Purchase _____

Remember to keep all receipts for proof of purchase.

Table of Contents

Gate Opener Class Categories-----	inside cover
Units and Standards Conversion Chart-----	inside cover
PLEASE READ THIS FIRST! -----	page iii
Important Safety Instructions -----	page 1
Disconnecting the Opener-----	page 1
Important Safety Instructions for the Consumer-----	page 2
Secondary Means of Protection Against Entrapment-----	page 5
Required Safety Precautions for Gates-----	page 6
Warning Signs and Labels-----	page 7
Installation -----	page 8
Parts List-----	page 8
Tools and Items Needed for Installation-----	page 9
Technical Specifications-----	page 10
Installation Overview-----	page 11
Installation of the Mounting Hardware-----	page 12
Mounting the Master Opener-----	page 16
Mounting the Second Opener-----	page 16
Installation of the Closed Position Stops-----	page 16
Trench and Lay Conduit for Wiring-----	page 19
Preparing To Connect The Wires -----	page 19
Attaching Master Battery and Communication Cables-----	page 20
Attaching Second Battery and Communication Cables-----	page 21
Powering Options: Transformer or Solar-----	page 22
Connecting the Battery-----	page 23
Connecting the Transformer-----	page 24
Connecting Solar Panel(s)-----	page 26
Master Control Board Settings -----	page 26
DIP Switches-----	page 26
Dual Mode DIP Switches-----	page 26
Stall Force and Auto-Close-----	page 27
Installing the Receiver-----	page 28
Setting the Closed Position Limit-----	page 29
Setting Your Personal Transmitter Code -----	page 30
Connecting Additional Safety Devices -----	page 31
Control Board Connections -----	page 32
Connecting Accessories -----	page 33
Routing Wires Through the Access Panel -----	page 34
Final Step -----	page 35
Push to Open Installation -----	page 36
Setting the Open Position Limit -----	page 37
Visual and Audible Diagnostic Indicators -----	page 39
Repair Service -----	page 41
Column Installation Information -----	page 42
Accessory Catalog -----	page 43

KEEP THESE INSTRUCTIONS FOR FUTURE REFERENCE



PLEASE READ THIS FIRST!

Thank you for purchasing a **Mighty Mule® 352 E-Z Gate Opener**—GTO's "do-it-yourself" automatic gate opener! When correctly installed and properly used, your **Mighty Mule® 352 E-Z Gate Opener** will give you many years of reliable service. Please read the following information and watch the enclosed video to ensure you have the correct system for your particular needs. Furthermore, this manual and the video will enable you to properly install your **Mighty Mule® 352 E-Z Gate Opener**.

The **Mighty Mule® 352 E-Z Gate Opener** is designed for installation on a **pull-to-open dual gate leafs** (gates that open *into* the property). By purchasing an *accessory bracket (FM148)*, the **Mighty Mule® 352 E-Z Gate Opener** can accommodate a **push-to-open dual gate leafs** (gates that open *out* from the property). The gates must not exceed 8 feet and 550 pounds or exceed 16 feet and 150 pounds (*please see Technical Specifications on page 10*). The **Mighty Mule® 352 EZ Gate Opener** can be used on vinyl, aluminum, chain link, farm tube, and wrought iron gates.

Use on solid (surface) gates is not recommended. Solid surface gates have a high resistance to the wind. If the wind is strong enough, the opener will obstruct and stop, blow fuses, or may damage the equipment.

The **Mighty Mule® 352 E-Z Gate Opener** accommodates extra transmitters, digital keypads, solar panels, push buttons, automatic gate locks, and other access control products. These optional accessories (see *the enclosed Mighty Mule® Accessory Catalog*) are available at most stores. Your store should be able to special order any accessory not in stock. If your store cannot special order accessories, please call the GTO Sales Department (800-543-GATE).

The **Mighty Mule® 352 E-Z Gate Opener** features **adjustable obstruction sensing**. This safety feature makes the gate stop and reverse direction within 2 seconds when it comes in contact with an obstruction. **MIN** is the factory setting; meaning the gate will exert the minimum force on an obstruction before it stops and reverses direction.

The **Mighty Mule® 352 E-Z Gate Opener** also has an **adjustable auto-close feature**. After the gate reaches the fully open position, it can be set to remain open up to 120 seconds before automatically closing. Pressing the transmitter button at any time after the gate opens fully will cause it to close immediately. **OFF** is the factory setting; meaning the gate will stay open until you press the transmitter (or keypad, etc.) again.

PLEASE NOTE—If your application requires any of the following:

- Slide gates;
- Heavy duty or commercial uses;
- Professional installation;

please call GTO at **(800) 543-GATE [4283]** or **(850) 575-0176** for information about our **GTO/PRO** professional line of gate openers and accessories. Our Sales Department will be glad to give you the name and phone number of a **GTO/PRO** dealer near you.

BEFORE YOU BEGIN TO INSTALL YOUR AUTOMATIC GATE OPENER: watch the enclosed video and read these instructions carefully and completely to become familiar with all parts and installation steps. The video is only designed as an overview of the installation procedure. You must read the installation manual for detailed instructions on gate opener safety and proper use of the gate opener.



IMPORTANT SAFETY INSTRUCTIONS



Because automatic gate openers produce high levels of force, consumers need to know the potential hazards associated with improperly designed, installed, and maintained automated gate opener systems. *Keep in mind that the gate opener is just one component of the total gate operating system.* Each component must work in unison to provide the consumer with convenience, security, and safety.

This manual contains various safety precautions and warnings for the consumer. Because there are many possible applications of the gate opener, the safety precautions and warnings contained in this manual cannot be completely exhaustive in nature. They do, however, provide an overview of the safe design, installation, and use of this product. **CAREFULLY READ AND FOLLOW ALL SAFETY PRECAUTIONS, WARNINGS, AND INSTALLATION INSTRUCTIONS TO ENSURE THE SAFE SYSTEM DESIGN, INSTALLATION, AND USE OF THIS PRODUCT.**

Precautions and warnings in this manual are identified with  this warning symbol. The symbol identifies conditions that can result in damage to the opener or its components, serious injury, or death.

Because GTO automatic gate openers are only part of the total gate operating system, it is the responsibility of the consumer to ensure that the total system is safe for its intended use.

To Manually Open and Close the Gate, Follow the Procedure Below:

 **CAUTION:** The gate will move freely and uncontrolled when the gate opener is removed from the gate. **ONLY** disconnect the opener when the opener power switch is **OFF** and the gate is **NOT** moving.

Disconnecting the Opener

1. Turn opener power switch **OFF**.
 2. Remove hairpin clip, clevis pin, and bushing from the front mounting point.
 3. Remove the opener from the mount.
- The gate can be opened and closed manually when the opener is disconnected.*

IMPORTANT: **NEVER** allow opener arm to hang by the front mount - it will break from the arm weight.

CAUTION: Because the Mighty Mule gate opener is battery powered, disconnect the opener **ONLY** when the power switch on the opener is turned **OFF**. Unplugging the transformer does not turn power to the opener **OFF**.

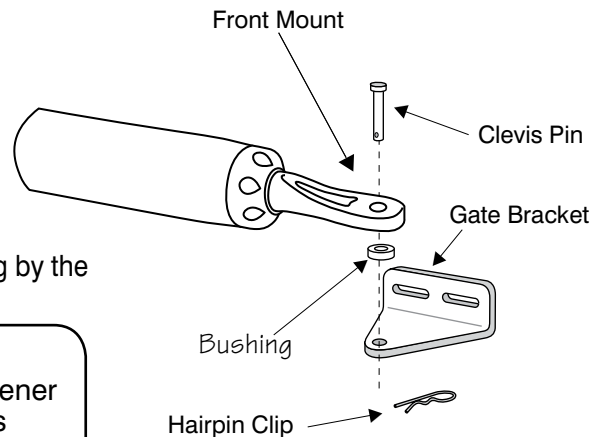

NOTE: Substitute a **Pin Lock (FM133)** for the clevis pin on the front mount only of the gate opener to prevent unauthorized removal of the opener from the gate (see *Accessory Catalog*).

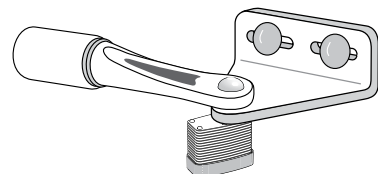



IMPORTANT SAFETY INSTRUCTIONS



For The Consumer

WARNING: To reduce the risk of injury or death:

1. **READ AND FOLLOW ALL INSTRUCTIONS.** Failure to meet the requirements set forth in the instruction manual could cause severe injury and/or death, for which the manufacturer cannot be held responsible.
2. When designing a system that will be entered from a highway or main thoroughfare, make sure the system is placed far enough from the road to prevent traffic congestion.
3. The gate must be installed in a location that provides adequate clearance between it and adjacent structures when opening and closing to reduce the risk of entrapment. Swinging gates **must not** open into public access areas.
4. The gate and gate opener installation **must comply with any applicable local codes.**

I. Before Installation

1. Verify this opener is proper for the type and size of gate, its frequency of use and the proper class rating.
2. Make sure the gate has been properly installed and swings freely in both directions. Repair or replace all worn or damaged gate hardware prior to installation. A freely moving gate will require less force to operate and will enhance the performance of the opener and safety devices used with the system.
3. Review the operation of the system to become familiar with its safety features. Understand how to disconnect the opener for manual gate operation (see page 1).
4. This gate opener is intended for **vehicular gates ONLY**. A separate entrance or gate must be installed for pedestrian use (see page 6).
5. Always keep people and objects away from the gate and its area of travel. **NO ONE SHOULD CROSS THE PATH OF A MOVING GATE.**
6. Pay close attention to the diagram below and be aware of these areas at all times.

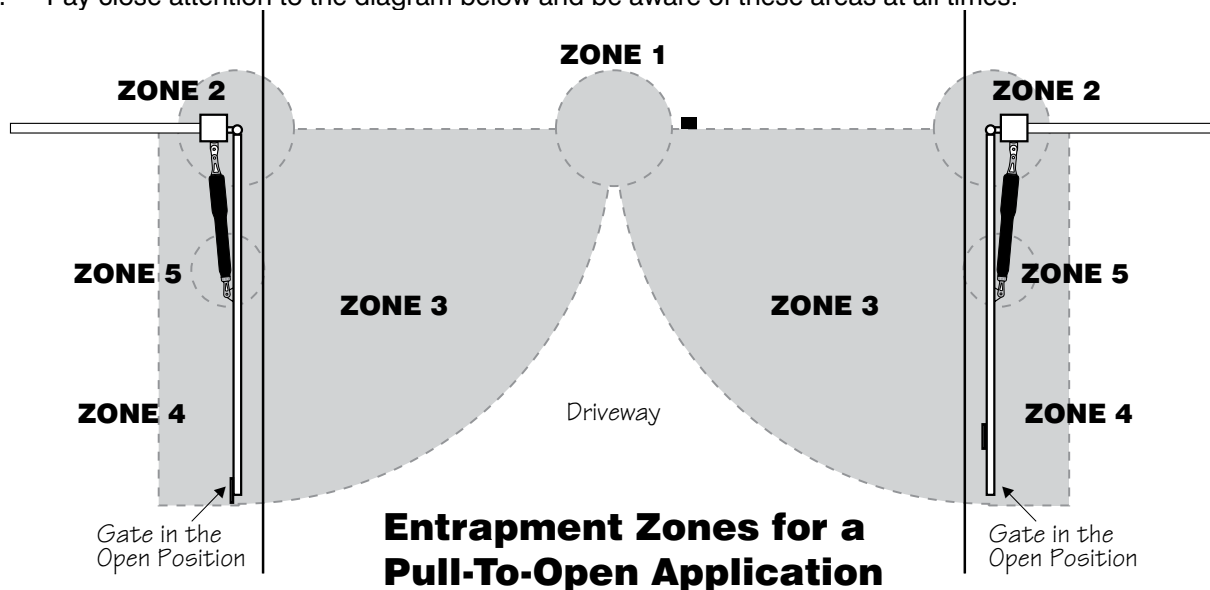



IMPORTANT SAFETY INSTRUCTIONS



Entrapment Zones for a proper Pull-To-Open installation:

Zone 1 – leading edge of the master and second gate.

Zone 2 – between the gate and the gate post.

Zone 3 – the path of the gate.

Zone 4 – the space between the gate in the open position and any object such as a wall, fence, tree, etc.

Zone 5 – pinch points between the opener and gate.

II. During Installation

1. Install the gate opener on the inside of the property and fence line. **DO NOT** install an opener on the outside of the gate where the public has access to it.
2. Be careful with moving parts and avoid close proximity to areas where fingers or hands could be pinched.
3. Devices such as contact sensors (safety edges) and non contact sensors (photo beams) provide additional protection against entrapment.
4. If push buttons or key switches are installed, they should be within sight of the gate, yet located at least 10 feet from any moving part of the gate (see diagram below). **Never install any control device where a user will be tempted to reach through the gate to activate the gate opener.**
5. Do not activate your gate opener unless you can see it and can determine that its area of travel is clear of people, pets, or other obstructions. Watch the gate through its entire movement.
6. Secure outdoor or easily accessed gate opener controls in order to prohibit unauthorized use of the gate.

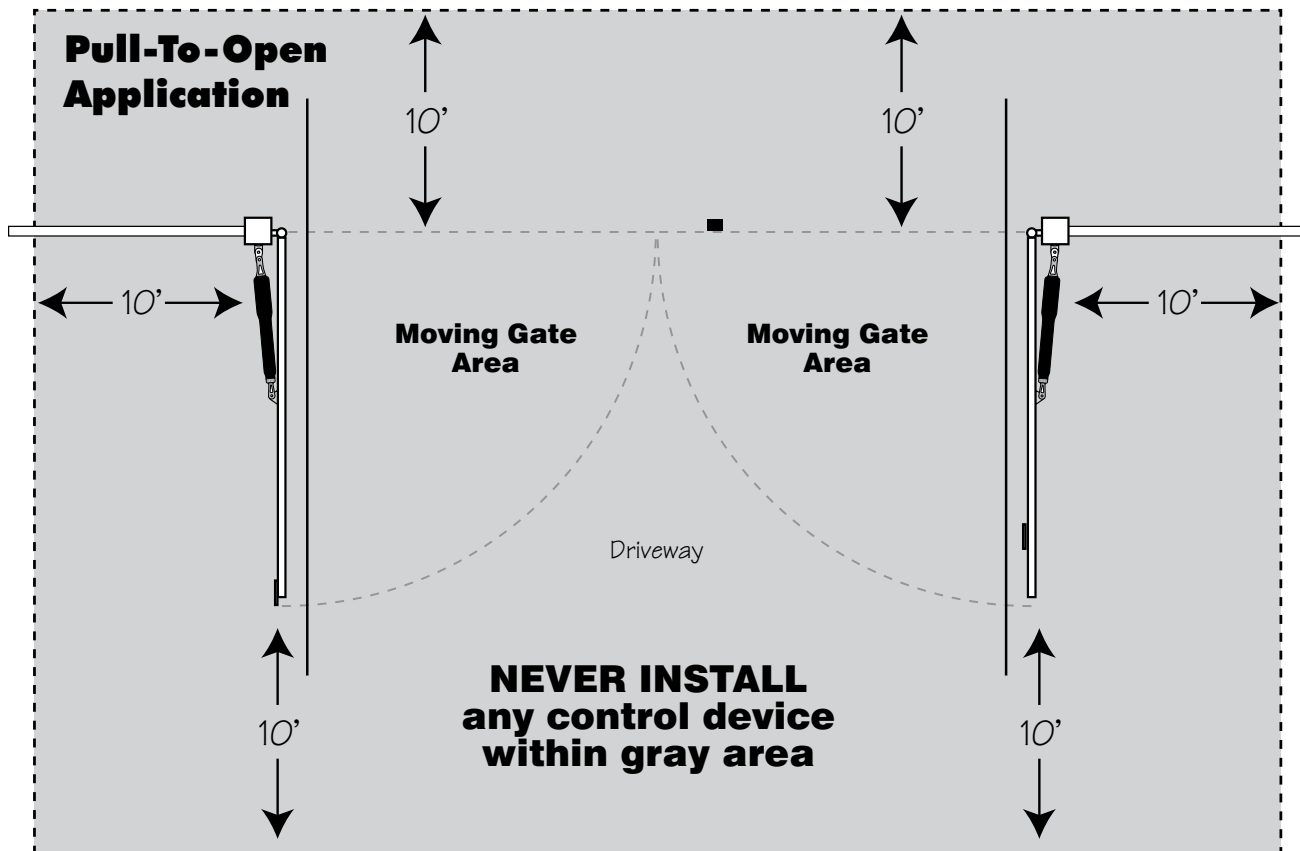



IMPORTANT SAFETY INSTRUCTIONS



III. After Installation

1. Attach the **warning signs** (*included*) to each side of the gate to alert the public of automatic gate operation. It is *your responsibility* to post warning signs on both sides of your gate. If any of these signs or warning decals become damaged, illegible or missing, replace them immediately. Contact GTO for free replacements.
2. The gate is automatic and could move at any time, posing a serious risk of entrapment. No one should be in contact with an activated gate when it is moving or stationary.
3. Do not attempt to drive into the gate area while the gate is moving; wait until the gate comes to a complete stop.
4. Do not attempt to "beat the gate" while the gate is closing. This is extremely dangerous.
5. Do not allow children or pets near your gate. **Never let children operate or play with gate controls.** Keep the remote controls away from children and unauthorized users; store controls where children and unauthorized users do not have access to them.
6. **KEEP GATES PROPERLY MAINTAINED.** Always turn power to opener OFF before performing any maintenance. Clean the push-pull tube with a soft, dry cloth and apply silicone spray to it at least once per month. Grease hinges, spray push pull tube with high quality silicone spray.
7. To operate this equipment safely, YOU must know how to disconnect the opener for manual gate operation (*see page 1*). If you have read the instructions and still do not understand how to disconnect the opener, contact the GTO Service Department.
8. Disconnect the opener **ONLY** when the power is **TURNED OFF** and the gate is **NOT** moving.
9. Make arrangements with local fire and law enforcement for emergency access.
10. Distribute and discuss copies of the **IMPORTANT SAFETY INSTRUCTIONS** section of this manual with all persons authorized to use your gate.
11. **IMPORTANT: Save these safety instructions. Make sure everyone who is using or will be around the gate and gate opener are aware of the dangers associated with automated gates. In the event you sell the property with the gate opener or sell the gate opener, provide a copy of these safety instructions to the new owner.**

Additional copies of this manual can be obtained by downloading one from the Mighty Mule® web site (www.mightymule.com), by contacting GTO, Inc., at 3121 Hartsfield Road, Tallahassee, Florida 32303 or by calling 1-800-543-4283 and requesting a duplicate copy. One will be provided to you free of charge.



IMPORTANT SAFETY INSTRUCTIONS



Secondary Means of Protection Against Entrapment

As specified by Gate Opener Safety Standard, UL 325 (30A.1.1), automatic gate openers shall have an inherent entrapment sensing system, and shall have *provisions for, or be supplied with*, at least one independent secondary means to protect against entrapment. The Mighty Mule® 352 utilizes **Type A**, an inherent (i.e., built-in) entrapment sensing system as the **primary** type of entrapment protection. Also, the Mighty Mule® has **provisions for** the connection of **Type B2** protection to be used as the **secondary** type of entrapment protection.

1. For gate openers utilizing a contact sensor (e.g., safety edge sensor– Type B2) in accordance with UL 325 (51.8.4 [i]):
 - A. One or more contact sensors shall be located at the leading edge, bottom edge, and post edge, both inside and outside of a vehicular swing gate system.
 - B. A hard wired contact sensor shall be located and its wiring arranged so that the communication between the sensor and the gate opener is not subjected to mechanical damage.
 - C. A wireless contact sensor such as one that transmits radio frequency (RF) signals to the gate opener for entrapment protection functions shall be located where the transmission of the signals are not obstructed or impeded by building structures, natural landscaping or similar obstruction. A wireless contact sensor shall function under the intended end-use conditions.

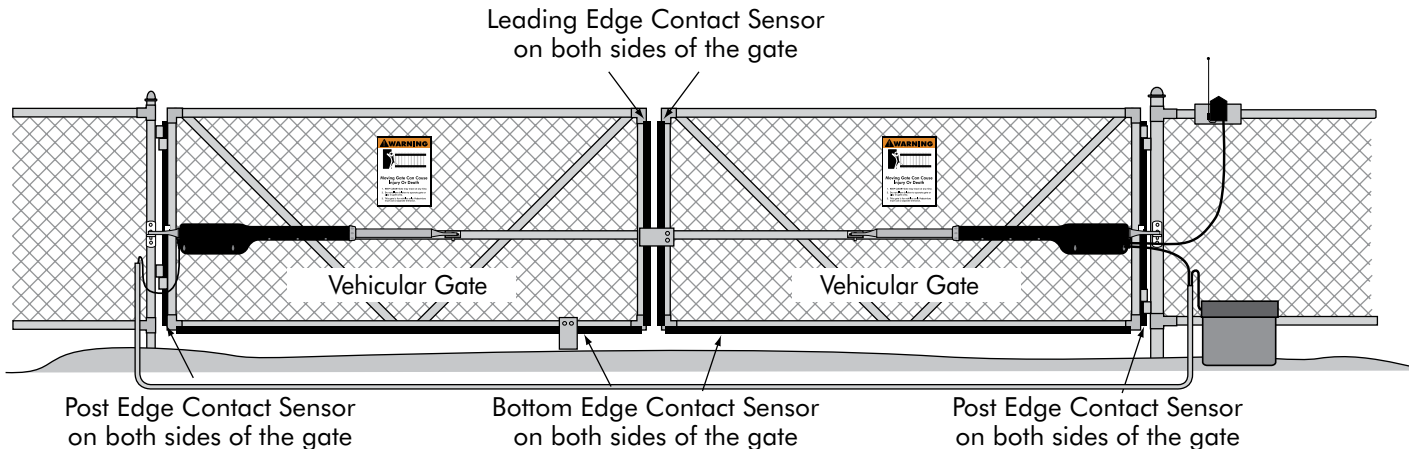

ENTRAPMENT ALARM (UL 325; 30A.1.1A)

The Mighty Mule® 352 Gate Opener is designed to stop and reverse within 2 seconds when the gate comes in contact with an obstruction. Additionally, these openers are equipped with an **audio entrapment alarm** which will activate if the unit obstructs **twice** while opening or closing. This alarm will sound for a period of 5 minutes, or until the opener receives an intended signal from a hardwired entry/exit source (e.g. push button control or keypad) and the gate returns to a fully open or fully closed position. Turning the power switch on the control box OFF and back ON will also deactivate the alarm. Wireless controls such as transmitters and wireless keypads will not deactivate the alarm.

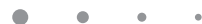



IMPORTANT SAFETY INSTRUCTIONS



Required Safety Precautions for Gates Install Warning Signs

Warning signs alert people of automatic gate operation and are **required** when installing the Mighty Mule® 352 E-Z Gate Opener. Furthermore, a walk-through gate must be installed if pedestrian traffic is expected near the vehicular gate. We recommend using the **GTO Bulldog Pedestrian Gate Lock** (Call the GTO Sales Department) for controlled access.

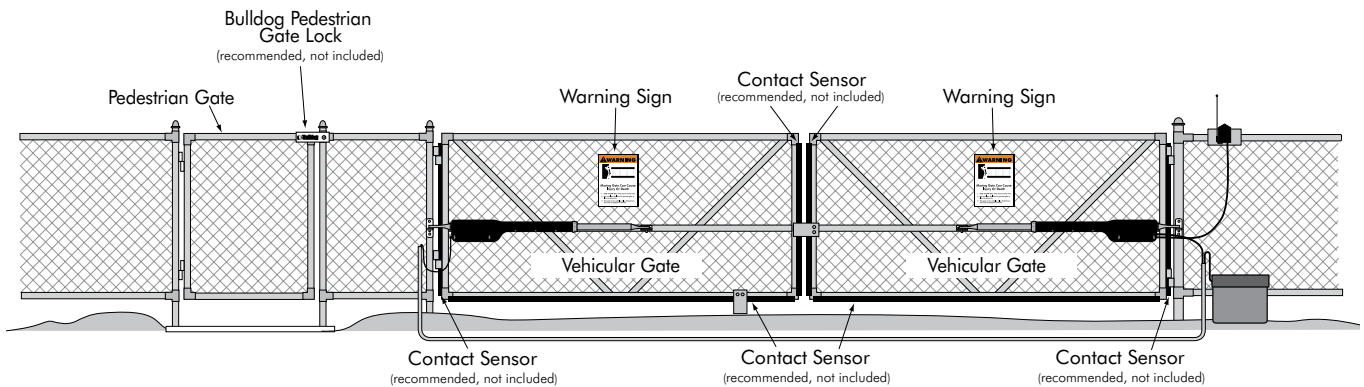

Entrapment Protection

GTO's inherent obstruction settings, even when properly adjusted, **may not be sensitive enough to prevent bodily injury in some circumstances**. For this reason, safety devices such as safety edge sensors (or photoelectric sensors), which stop and reverse gate direction upon sensing an obstruction, are suggested for enhanced protection against entrapment.

Warning Signs

The warning signs (at right) must be installed on both sides of the gate (see page 7 for details).





IMPORTANT SAFETY INSTRUCTIONS



! WARNING



Moving Gate Can Cause Injury Or Death

- 1. KEEP CLEAR! Gate may move at any time.**
- 2. Do not allow children to operate gate or play in gate area.**
- 3. This gate is for vehicles only. Pedestrians must use a separate entrance.**

These warning labels should be found at the locations specified below. If any of them are missing, immediately contact GTO for replacements.

Product identification label



This label is located under rear mount on the opener.

Warning signs (4 enclosed) to be installed on each side of the gate (3-5 feet above the bottom of the gate).



E-Z GATE® OPENER UL325 SERIES

1-800-543-GATE (4283) • www.mightymule.com

TO MANUALLY OPEN AND CLOSE THE GATE

1. Turn opener power switch OFF.
2. Disconnect front or rear mount from mounting bracket.
3. Pull opener away from mounting bracket and move gate.

Disconnect opener **ONLY** when the power switch is OFF and the gate is not moving.

! WARNING !

MOVING GATE!



Can Cause Injury or Death

1. KEEP CLEAR! Gate may move at any time.
2. Do not allow children to operate gate or play in gate area.
3. This gate is for vehicles only. Pedestrians must use separate entrance.

Maximum Gate: 550 lbs. (249.4 kg); 16 ft. (4.9 m) • Voltage: 12 Vdc; Frequency: 0Hz; Power: 25W • Class I, II, and III Vehicular Swing Gate Operator

Logo and warning labels (2) installed on each side of opener housing.



Parts List - Opener and Mounting Hardware

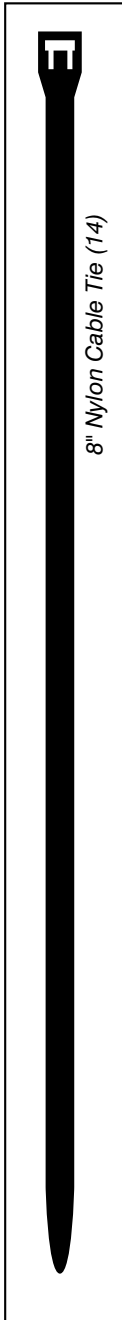
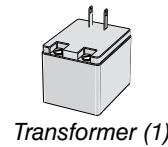
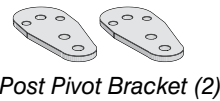
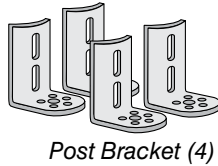
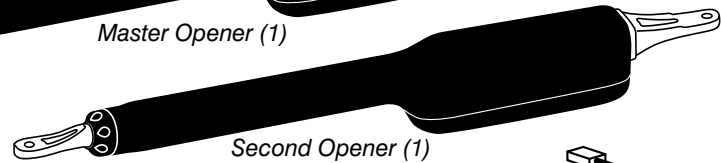
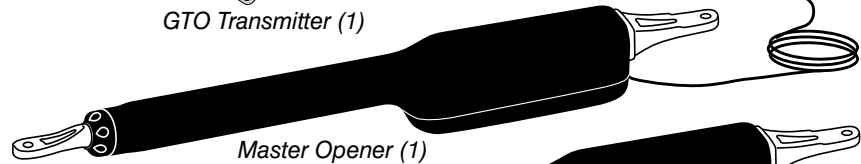
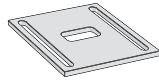
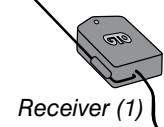
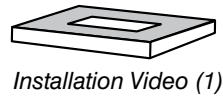
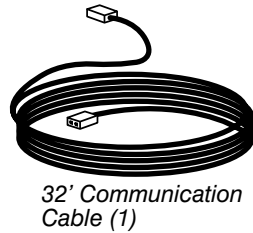
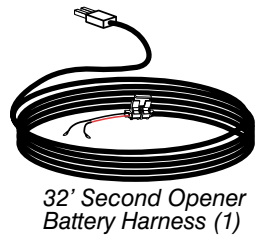

Hardware Bag Contents

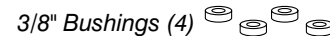
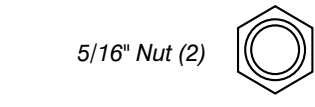
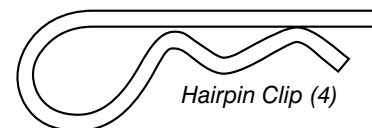
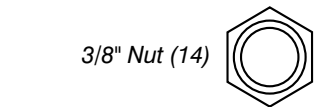
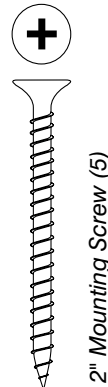
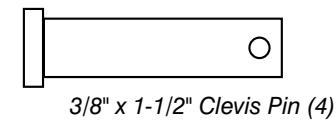
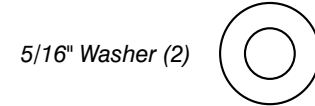
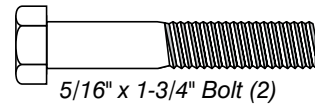
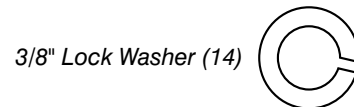
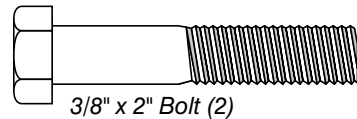
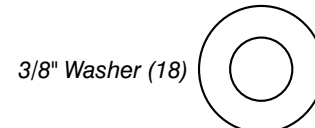
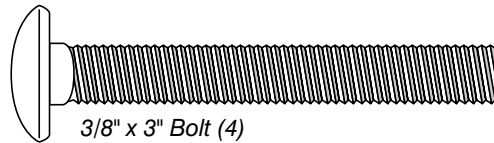

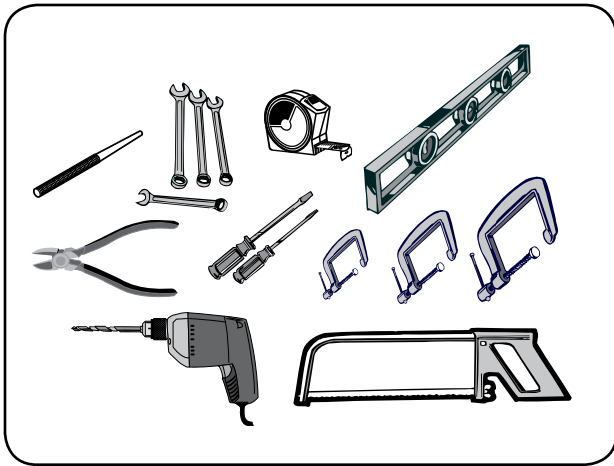

Tools Needed

- Center Punch
- Open End Wrenches — 3/8", 7/16", 1/2", and 9/16"
- Small (Flat Bladed) Screwdriver
- Tape Measure
- Level
- Wire Strippers
- Phillips Screwdriver/ Large
- C-Clamps — small, medium, and large
- Power Drill
- 3/8" Drill Bit
- Hacksaw or Heavy Duty Bolt Cutters
- Extra person will be helpful

YOU MAY ALSO NEED THESE ITEMS BEFORE YOU BEGIN THE INSTALLATION (Some of these items can be found in the *Accessory Catalog* page 42):

- **Low voltage wire (RB509)** will be needed to run from the transformer to the opener control board; length depends upon the distance between the transformer power supply and the opener arm. See **Powering Options: Transformer or Solar** on page 22, and the *Accessory Catalog*.
- If your gate is more than 1000' away from AC power source you will need to use at least one **Mighty Mule® 10 watt Solar Panel (FM123)** to charge the 12 Volt automotive or marine type battery (not included). See the *Accessory Catalog*.
- If your fence post is made of wood and is less than 6" in diameter or 6" square, see page 12.
- Metal plate or washer between nuts and fence posts to prevent pulling bolts out of wood.
- If your fence post is larger than 6" in diameter you will need **threaded rods or carriage bolts longer than 8"**. See page 15.
- Low profile ground stop page 17.
- PVC conduit.
- If you have thin walled tube or panel gates, see **Recommended Reinforcement Examples** on page 12.
- Depending on the type of gate, **a horizontal cross member or mounting plate may be needed** to mount the front of the opener and gate bracket to the gate. See page 11, step 2; page 15, step 10.
- Surge protection for transformer.
- Some types of installations require U-Bolts.
- Spade terminal for transformer page 25, step 4.

Technical Specifications

MIGHTY MULE® 352 E-Z GATE OPENER

DRIVE

- Low friction screw drive (linear actuator) rated for -5 °F to +160 °F (-21 °C to +71 °C).
- Powered by a 12 V motor with integral case hardened steel gear reducer. Motor speed reduced to 260 rpm. Generates 520 inch lb. of torque at 12 V.
- Maximum opening arc of 110°. Approximate opening time (90°): 18 seconds, depending on weight of gate.

POWER

- The system is powered by a 12 Vdc automotive or marine battery.
- Battery charge is maintained by a 120 Vac, 18 Vac output transformer [rectified to 14.5 Vdc (40 VA) through the GTO control board] or by optional GTO Solar Panels [the panel should generate minimum of 10 W at 600 mA]. A diode on the control board prevents battery discharge.

IMPORTANT: Never use both transformer and solar panel - this will damage the battery and control board.

- One (1) blade-style control board fuse is rated for 15 A.

NOTE: The transformer should not be directly connected to any battery. Do not replace fuses with higher ampere rated fuses; doing so will void your warranty and may damage your control board.

CONTROL

- **GTO** microprocessor-based control board is set for dual leaf, pull-to-open gate installations. DIP switches can be adjusted to accommodate an optional kit for push-to-open gates (see *Accessory Catalog*).
- Control board has temperature compensated circuits.
- A circuit on the control board regulates charging. "Sleep draw" is 25 mA; "active draw" is 2 to 5 A.
- Auto-memorization of digital transmitter code.
- GTO remote-mounted RF receiver tuned to 318 MHz.
- Opener length with push-pull tube fully retracted is 37¹/₄", mounting point to mounting point. Max stroke 19".
- Adjustable auto-close timer (OFF to 120 s), and obstruction sensitivity.
- Power terminal block accommodates a transformer or solar panels.
- DIP switches simplify setup of gate opener.
- Accessory terminal block fully compatible with all Mighty Mule access controls.
- Control board allows connection of safety edge sensors and photoelectric sensors.
- Audio entrapment alarm sounds if unit encounters an obstruction twice while opening or closing.

OPERATIONAL CAPACITY

- The Gate Capacity Chart shows approximate cycles, per day, you can expect from the Mighty Mule 352 Automatic Gate Opener when powered with a transformer. Actual cycles may vary slightly depending upon the type and condition of gate and installation.

Mighty Mule 352 Gate Capacity /Cycle Chart

Estimated number of daily cycles, based on use with a transformer and one(1) 12 Volt battery.

		Number of Cycles Per Day					
Gate Weight	550 lbs.	62	57	NR	NR	NR	NR
	450 lbs.	67	62	57	NR	NR	NR
	350 lbs.	72	67	62	57	NR	NR
	250 lbs.	77	72	67	62	57	NR
	150 lbs.	82	77	72	67	62	57
	100 lbs.	87	82	77	72	67	62
	50 lbs.	92	87	82	77	72	67
	5' - 6'	8'	10'	12'	14'	16'	
		Gate Length					

NOTE: "NR" indicates this size and weight combination is not recommended for the Mighty Mule 352.

* These specifications are subject to change without notice.

NOTE: BALL BEARING HINGES SHOULD BE USED ON ALL GATES WEIGHING OVER 250 LB.

To determine the number of cycles the gate opener will perform using solar panels, please see the specifications listed on page 22 or call (800) 543-1236 or (850) 575-4144 for more information.

* An operation cycle is one full opening and closing of the gate.

Installation Overview

Pull-to-Open Gates (Gate Opens into the Property)

The diagram shown below is an example of a pull-to-open installation on a chain link fence and dual gate. Mounting the openers on masonry columns requires special procedures; see **Column Installation Information** on page 42 if you intend to mount the openers on columns. Furthermore, if you have push-to-open gates, you will need to purchase 2 **push-to-open brackets (FM148)** (see *Accessory Catalog*) to properly configure your system. See **push-to-open installation** on page 36 before proceeding.

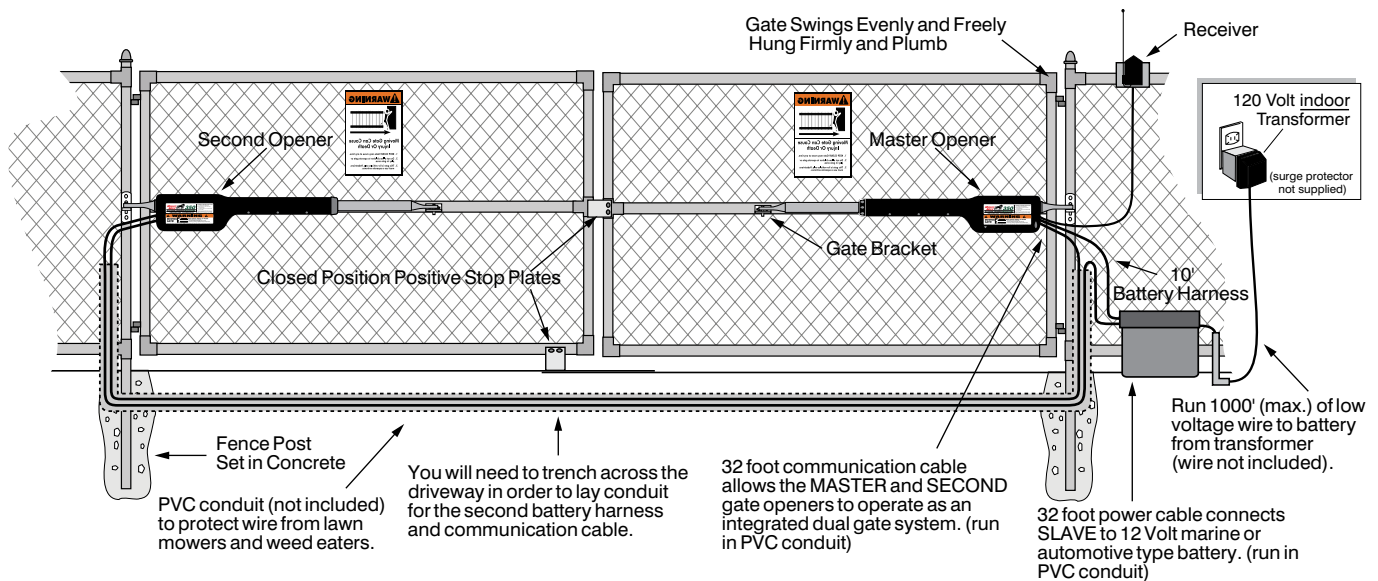

Preparation of the Gate

Step 1

The gate **must** be plumb, level, and swing freely on its hinges. Wheels must not be attached to the gate. The gate must move throughout its arc **without binding or dragging on the ground**. Note that gates over 250 lb. should have ball bearing hinges with grease fittings.

Step 2

The fence post must be secured in the ground with concrete so it will minimize twist or flex when the opener is activated. We recommend you position the opener near the **centerline** of the gate to keep the gate from twisting and flexing and to avoid backsplash from rainwater. The addition of a **horizontal or vertical cross member** (if one is not already in place) to provide a stable area for mounting the gate bracket is also important.

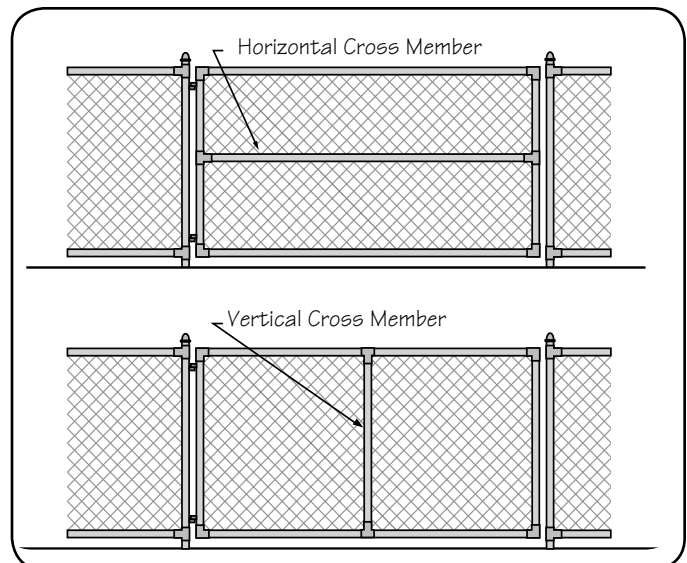

Installation of Mounting Hardware

The position of the post bracket determines the leverage and efficiency of the opener. The post bracket position also sets the clearance between the opener and gate in the open and closed positions (minimum 2 inches for safety reasons).

The curved design of the post bracket works well for installations on round and square fence posts. Because the post bracket carries the entire thrust of the active opener, **bolts that completely penetrate the fence post must be used.**

On wooden posts, place a metal plate or washer (*not supplied*) between the nuts and the fence post to prevent the thrust of the opener from pulling the bolts and washers out of the wood.

NOTE: A fence post smaller than 6" in diameter or 6" square should be made of metal instead of wood so that it will remain stable while the opener is moving the gate.

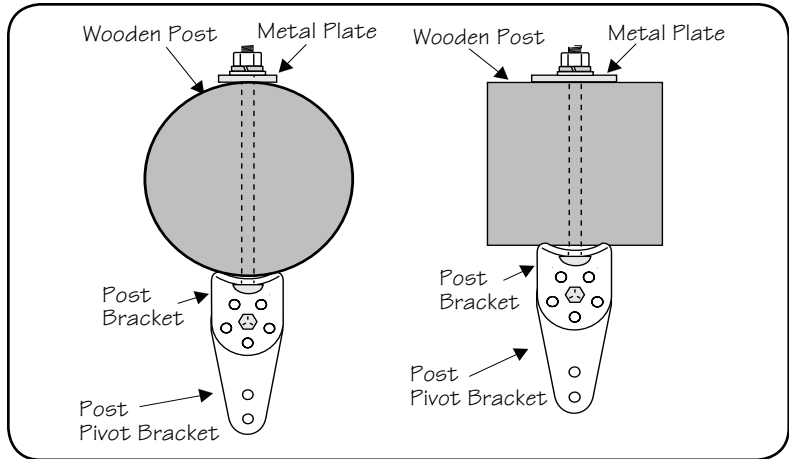

On round posts of 6" diameter or larger, the post pivot bracket may not be necessary for the installation. In this instance, the two post brackets are mounted by themselves.

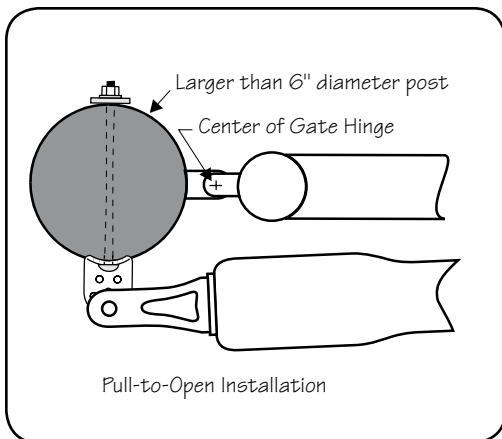

IMPORTANT:

We **strongly recommend** using steel pipe, wood or metal to reinforce thin walled tube gates or wood to reinforce panel gates as shown. These reinforcement methods will prevent damage to the opener and gate when the opener is installed.

Recommended Reinforcement Examples

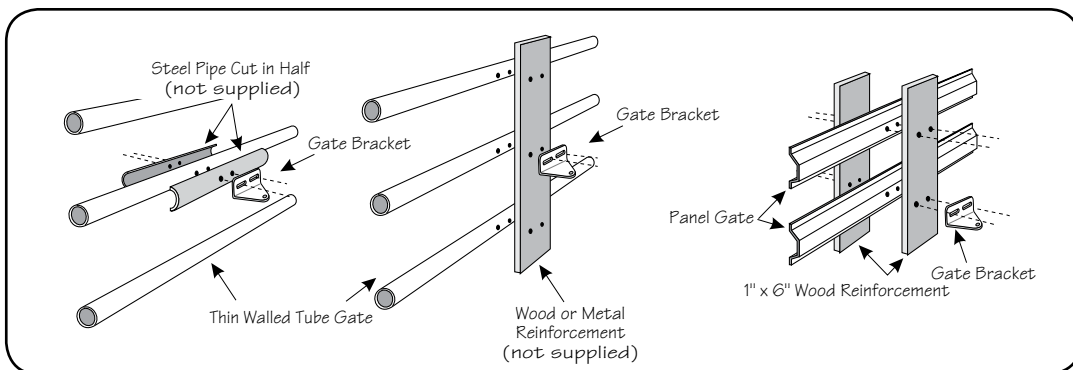

Determining the Mounting Position of the Post Bracket Assembly and the Gate Bracket

Step 3

Insert the 3/8" x 2" bolt through the center hole of the post brackets and post pivot bracket as shown. Fasten a 3/8" washer, 3/8" lock washer and 3/8" nut on the end of the bolt. **DO NOT overtighten** the nut because the post pivot bracket will have to be adjusted later.

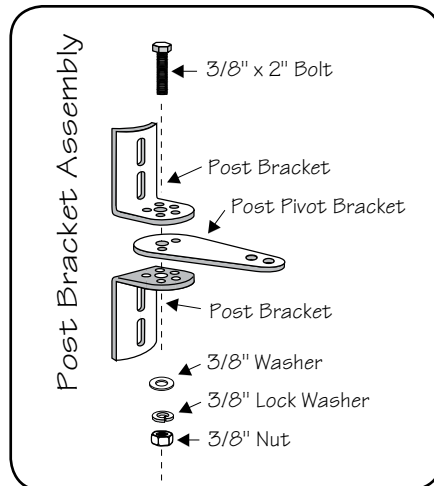

NOTE: The following steps are intended for **pull-to-open** gate installations. If you are mounting your opener on a push-to-open gate (e.g., a gate on a sloped driveway) you will need to purchase a **Push To Open bracket** (FM148) (see *Accessory catalog*). Also, see **Push-to-Open Installation** beginning on page 36.

Step 4

Attach post bracket assembly and gate bracket to the opener with the clevis pins and bushings. Secure the clevis pins with hairpin clips.

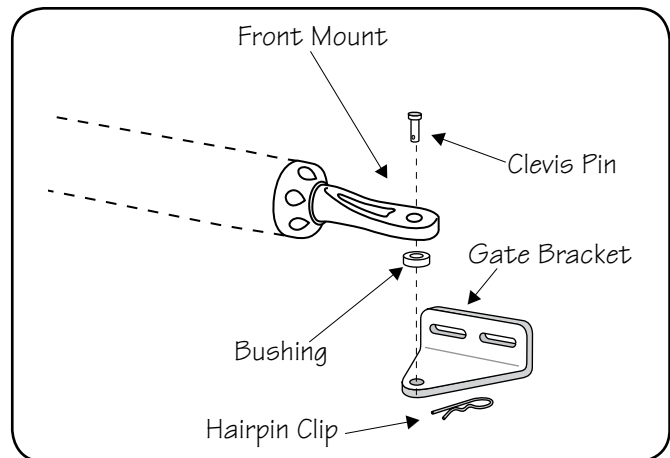
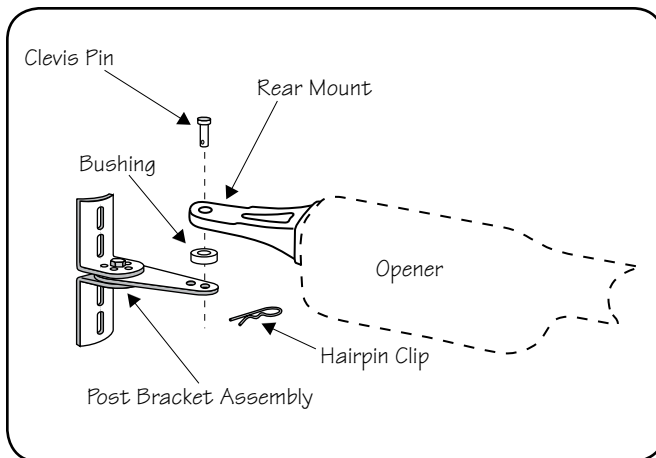

Step 5

With the gate in the open position (up to 110° from its closed position), and the opener fully retracted, adjust the post bracket assembly and gate bracket until the opener is level. While holding the opener level, use C-clamps to **temporarily** keep the post bracket assembly and gate bracket in their respective positions on the fence post and gate.

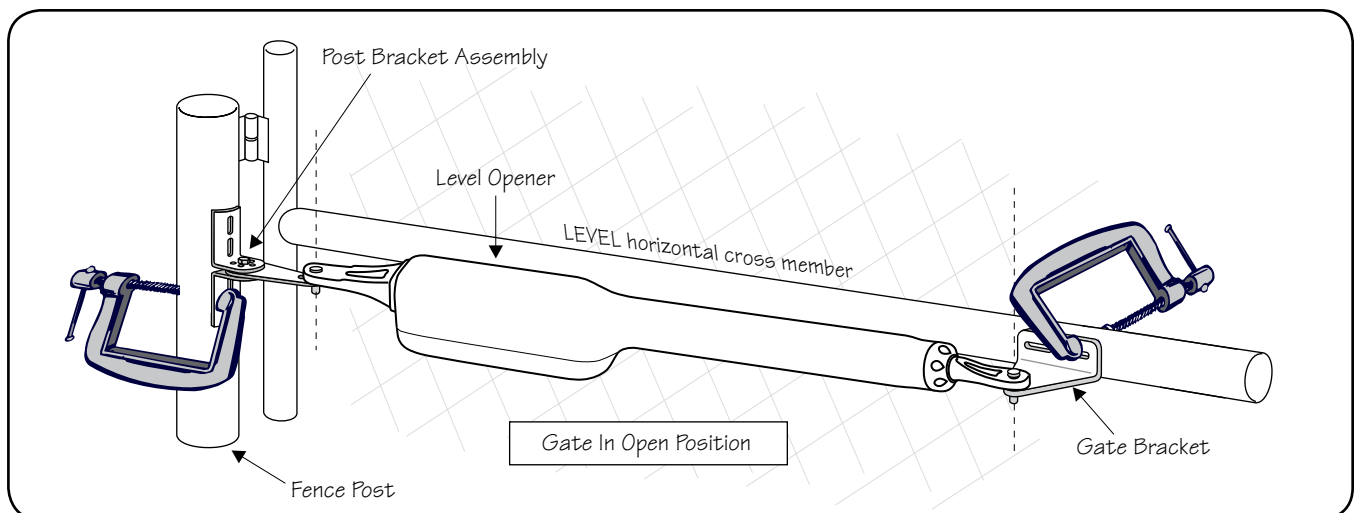

IMPORTANT: While determining the mounting point for the post pivot bracket assembly, be sure that the position allows for minimum 2 inches of clearance between the gate and the opener in both the open and closed positions, as shown in the diagrams below. This clearance will give the opener the most efficient leverage point for opening and closing the gate and more importantly provides the least possible pinch area.

Step 6

After verifying that you have the best position for the post pivot bracket in the open position, insert the 5/16" x 1-3/4" bolt through the aligned holes of the post bracket and post pivot bracket to hold it in place. Remove the clevis pin from the front mount and while supporting the gate opener, swing the gate and gate opener to the closed position. With the gate and gate opener in the closed position check the clearance and be sure that the gate opener is not binding at the post pivot bracket.

If you don't have 2 inches of clearance or the gate opener is binding on the post pivot bracket, remove the 5/16" x 1-3/4" bolt and readjust the pivot bracket until you can achieve these important clearances.

With the post pivot bracket in the optimum position for clearance and freedom of movement, reattach the opener to the gate bracket in the open position and recheck the gate opener level and make sure the brackets are clamped securely.

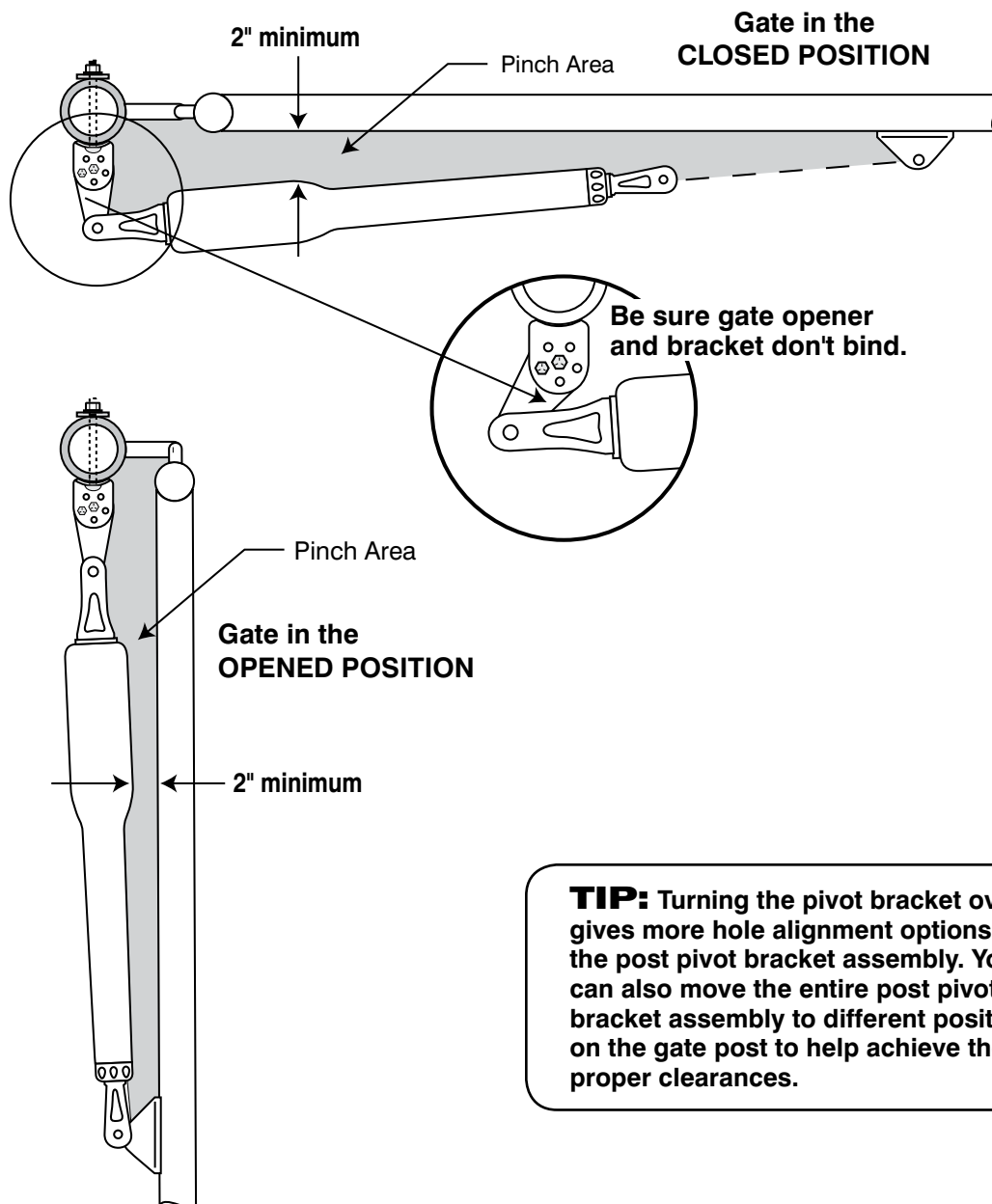

TIP: Turning the pivot bracket over gives more hole alignment options for the post pivot bracket assembly. You can also move the entire post pivot bracket assembly to different positions on the gate post to help achieve the proper clearances.

Installing the Post Bracket Assembly and Gate Bracket

Step 7

Mark reference points for bolt holes on the fence post through middle of bracket slots. Marking reference points in this manner allows room for adjustment when mounting the post bracket assembly and gate bracket. After marking your reference points, remove the opener and brackets from the fence and gate.

Step 8

Drill $\frac{3}{8}$ " holes into fence post as marked.

Step 9

Fasten post bracket assembly to the fence post using (4) $\frac{3}{8}$ " x 8" bolts, washers, lock washers, and nuts (*provided*). Remove excess bolt length extending beyond the tightened nuts with a hacksaw or bolt cutters.

NOTE: In cases where the fence post has a diameter larger than 6", **threaded rods or carriage bolts longer than 8"** (*not supplied*) must be used.

Step 10

Mark reference points for bolt holes on the gate cross member through middle of gate bracket slots. Drill $\frac{3}{8}$ " holes into the gate cross member as marked.

Mount gate bracket using (2) $\frac{3}{8}$ " x 3" bolts, washers, lock washers, and nuts (*provided*). Cut off excess bolt length extending beyond the tightened nuts.

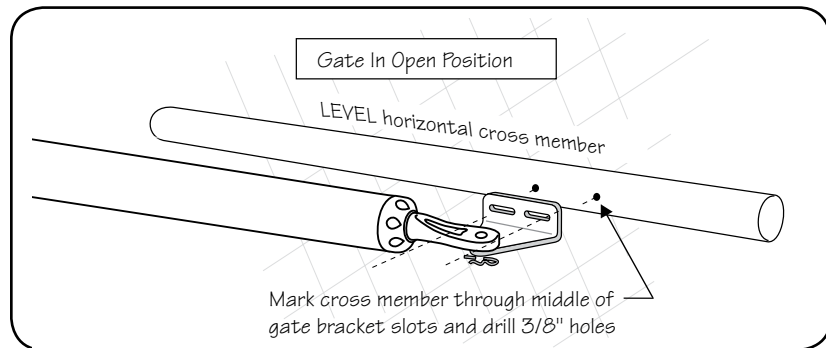
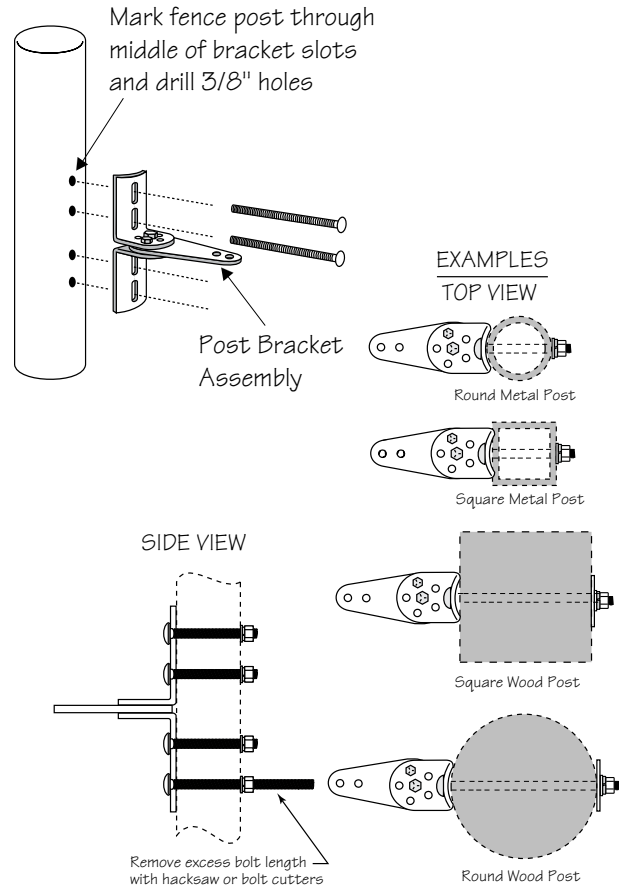

Gate Bracket Mounting Examples

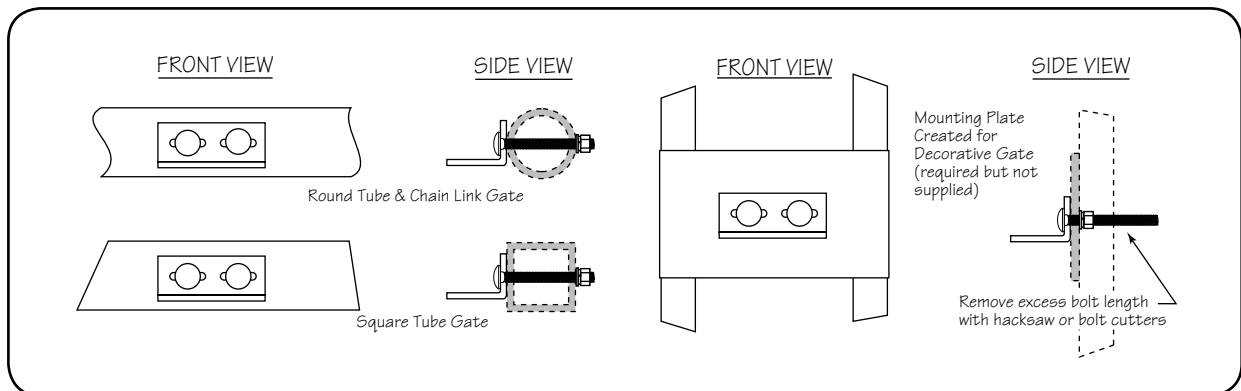

Mounting the Master Opener

Step 11

Attach the opener to the securely bolted post bracket assembly and gate bracket using clevis pins, bushings, and hairpin clips, or optional Pin Locks (see *Accessory Catalog*). Verify that the opener is level and adjust the post bracket assembly if necessary.

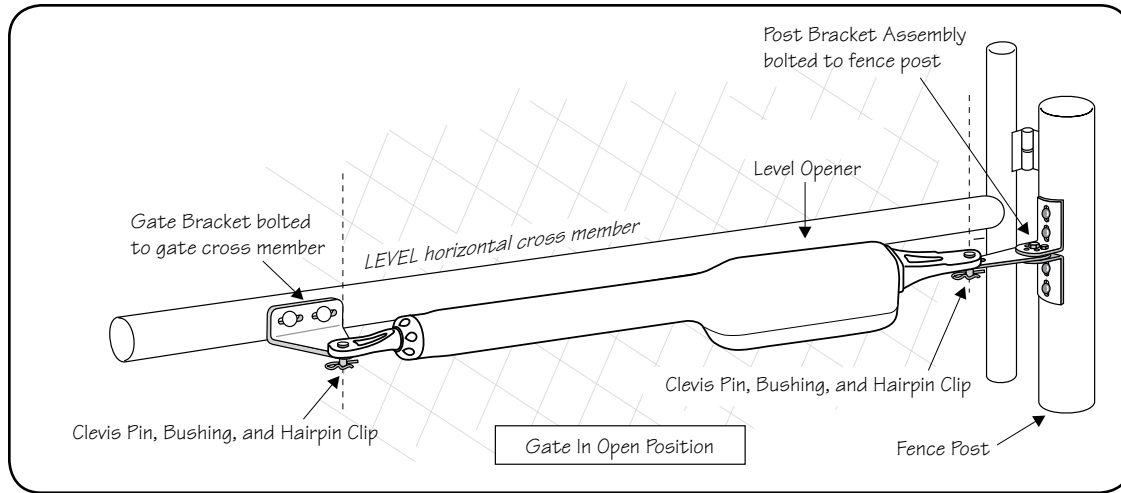

Mounting the Second Opener

Step 12

Install the second opener on the remaining gate leaf by repeating **Step 3** through **Step 11**, starting on page 13. After you have mounted the second opener, proceed to **Installing the Positive Stops**.

Installation of the Closed Position Stops

The Mighty Mule® 352 Gate Openers firmly hold the gates in the closed position using positive stops. The positive stops help stabilize the gate leaves in the closed position. To further enhance stability and security, we strongly recommended using an optional **Mighty Mule® Automatic Gate Lock** (see *Accessory Catalog*) with your dual gate.

Illustration A

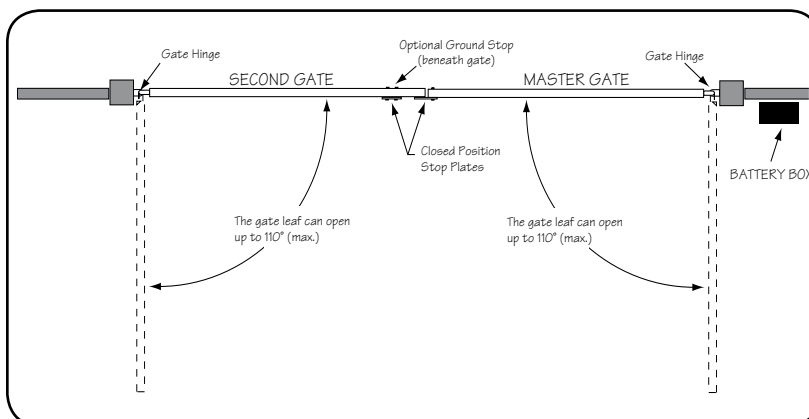

IMPORTANT: You need to determine which side of the driveway you will place the battery. The **MASTER** gate and gate opener should be mounted on the same side as the battery. The gate and gate opener on the opposite side of the driveway from the **MASTER** and battery will be referred to as the **SECOND** gate and gate opener.

Step 1

Attach the horizontal closed position stop plate to the MASTER gate leaf.

Detach the gate operators from the gates and move the gates to their closed position (*Illustration A*). Using appropriate hardware for your type of gate (U-bolts for tube or chain link; screw or bolts for wood or metal - **not supplied**) attach the *closed position stop plate (horizontally)* about mid height on the MASTER gate frame. **Do not** tighten it completely at this time. Slide the stop plate toward the frame of the SECOND gate leaf until they touch (*Illustration B*). Once you have moved the stop plate to the correct position, tighten its hardware completely.

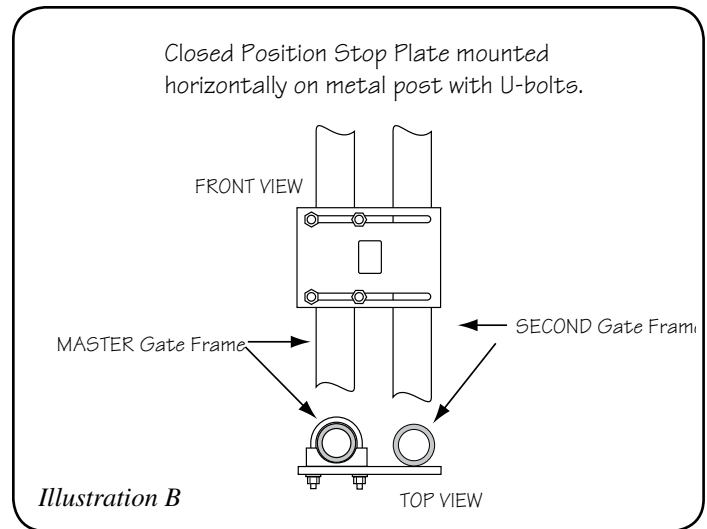

NOTE: The optional ground stop post is used to provide a secure point for the SECOND gate to close against. If you will be using the GTO Horizontal Gate Lock accessory with your gate opener system, the closed position ground stop is **REQUIRED**, as shown in Steps 2 and 3.

Step 2

Install a low profile ground stop (*not provided*) beneath the SECOND gate stop plate.

The ground stop needs to be positioned near the end of the gate as shown in *Illustration A* and may be made of metal or concrete and should be firmly secured in the ground (we recommend setting it in concrete).

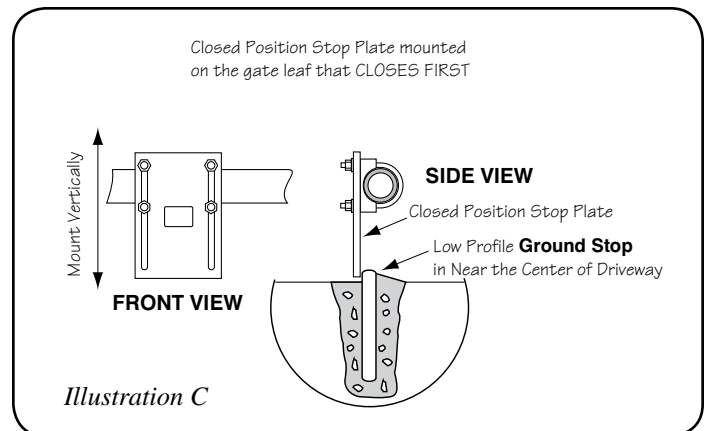

Step 3

Attach a vertical closed position stop plate to the **SECOND** gate.

Using appropriate hardware for your type of gate attach the vertical *closed position stop plate* to the SECOND gate frame at the point where it will come in contact with the ground stop post. **Do not** tighten it completely at this time. You must slide the closed position stop plate toward the *ground stop* until they touch (*Illustration C*). Once you have moved the stop plate to the correct position, tighten its hardware completely.

NOTE: For a push-to-open installation (gates open *out* from the property) attach the closed position stop plate to the **outside** of the gate.

At this stage of the installation, the openers should be installed on the gate leaves and the open and closed position stops should be in place.

Check List

- The gate is plumb, level, and swings smoothly on its hinges.
- A plate or support was added for the gate bracket (if necessary).
- The openers are level and mounted on the centerline of the gate.

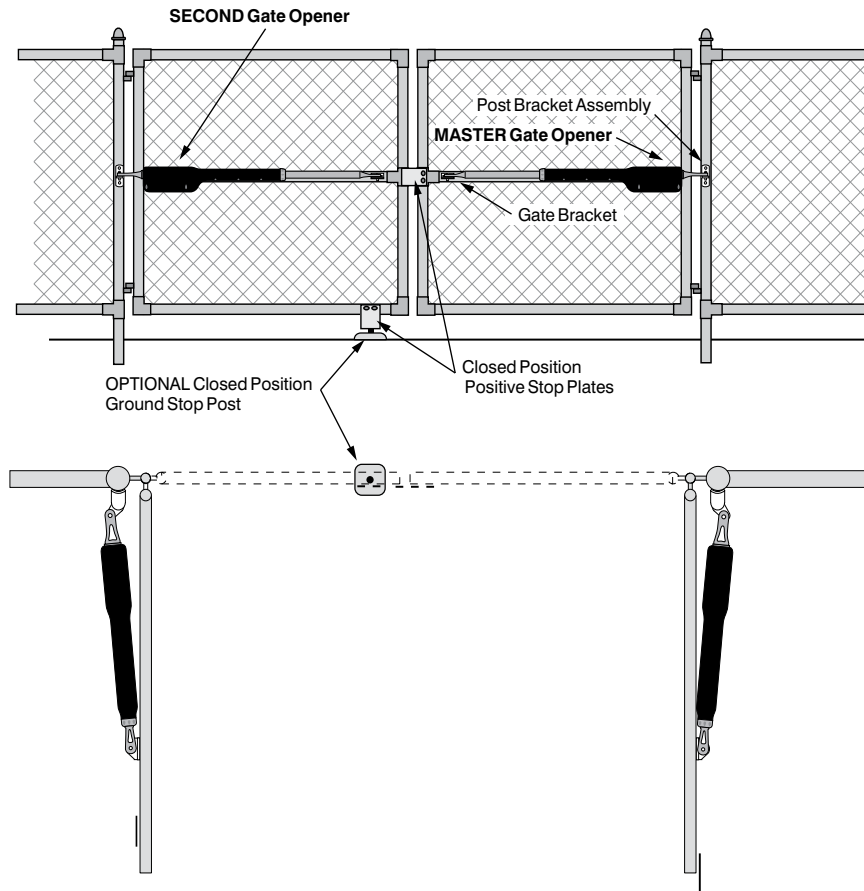

Trench and Lay Conduit for Wiring

Step 1

Trench and place 3/4 inch or larger PVC conduit from Master Opener Arm to Second Opener Arm. At this time you may also choose to trench and lay conduit from an AC power source to the gate for connecting the 18V transformer.

NOTE: If using solar power, trenching for the transformer is not necessary

Step 2

Route the 32 foot second battery harness cable and 32 foot Communication Cable through the PVC conduit running from the Second Opener Arm to the Master Opener Arm.

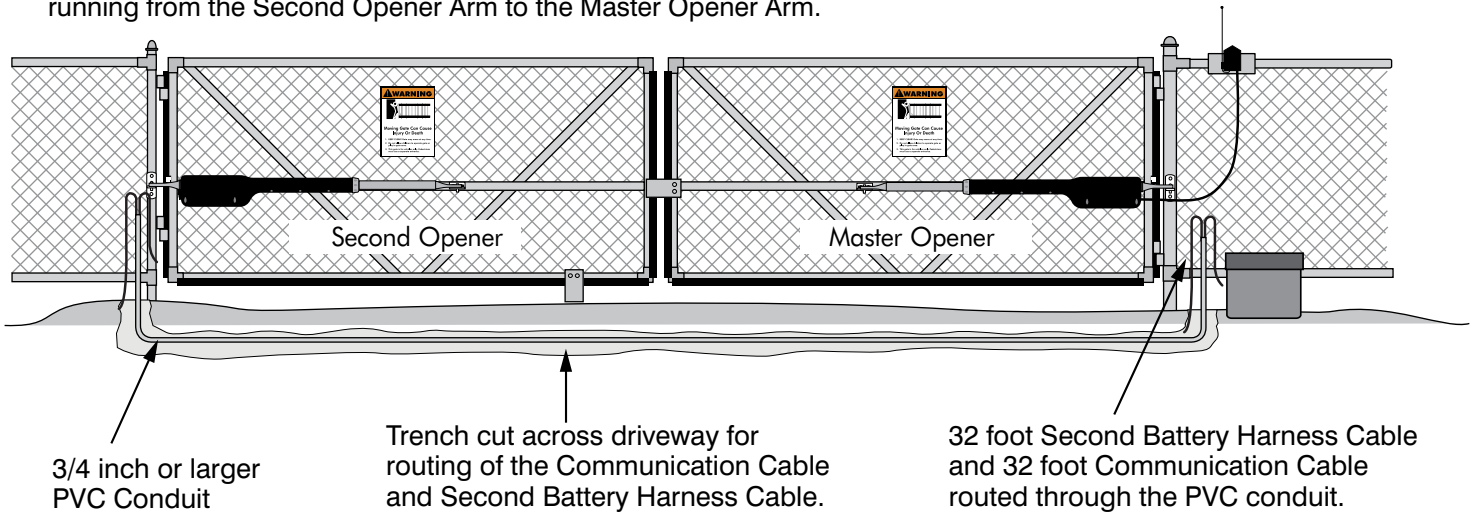

IMPORTANT: After trenching driveway follow these guidelines for PVC installation and running wire.

- **DON'T** use too many curves in PVC. Use sweeping 90° angles. Wire should be easily removeable if needed.
- **DON'T** splice wire. This can cause a voltage drop and can interfere with sequencing and the rev counter.
- **DON'T** run wire in same conduit as AC wiring. This causes communication interference and electrical noise.
- **DO** use minimum of 3/4" ID (interior diameter) PVC conduit available at your local home improvement store.

Preparing to Connect the Wires

In order to have easy access to the control boards during the rest of the installation, remove the master and second openers and remount them upside down.

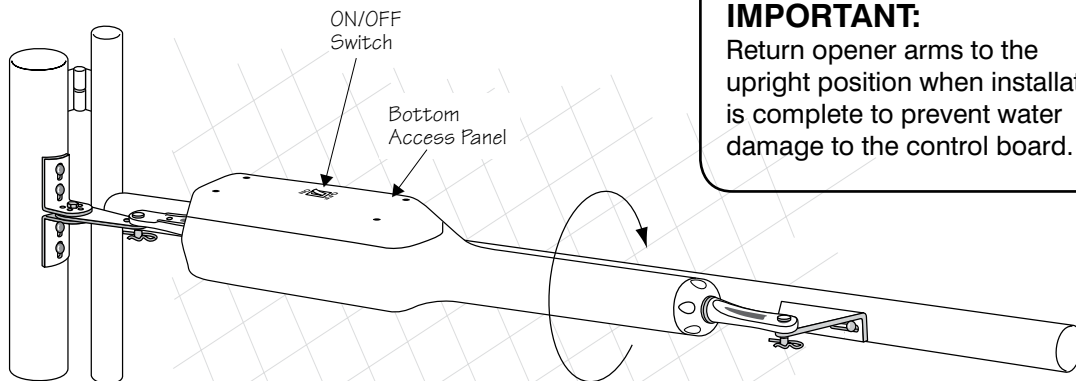

IMPORTANT:

Return opener arms to the upright position when installation is complete to prevent water damage to the control board.

Attaching Master Opener Battery and Communication Cables

NOTE: At this point your 32 foot Power Cable and 32 foot Communication Cable should be run through conduit to connect your master and second.

Step 1

With the MASTER opener mounted in the upside down position remove the Control Board Access Panel on the bottom of the opener arm.

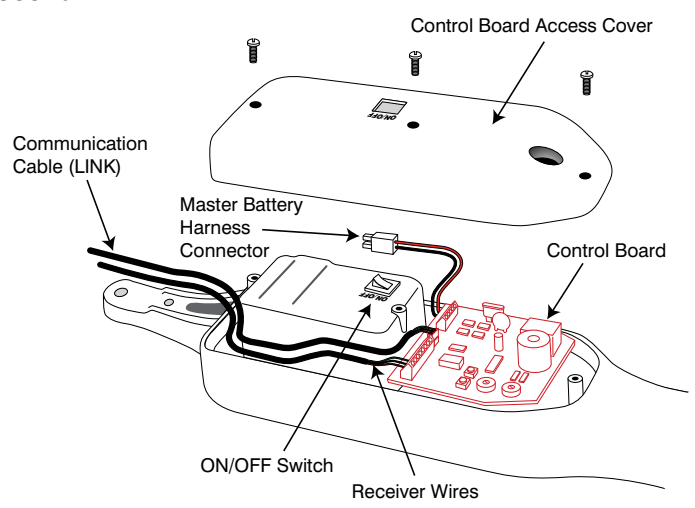

Step 2

Place the 12 Volt automotive or marine type battery and its weatherproof case within 6 feet of the fence post where the master opener arm is mounted.

Step 3

Connect the Communication Cable coming out of the conduit from the Second Opener to the LINK terminal on the master opener arm control board. Be sure to leave enough slack in the cable to accomodate routing of cable through access panel.

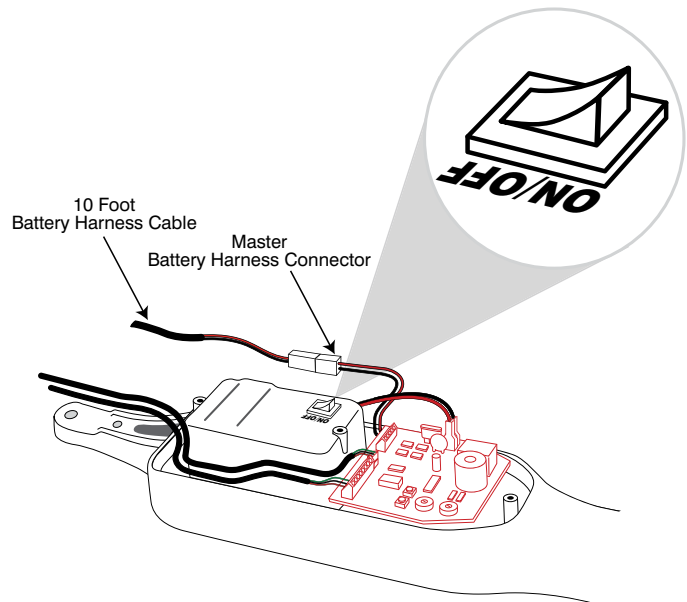

Step 4

Run the end of the 10 foot Master Battery Harness cable up to the Master Opener and plug it into the Battery Harness Connector located in the opener access panel. **DO NOT** connect the other end of the Battery Harness cable at this point.

Step 5

IMPORTANT: Make sure the power switch on the opener arm is in the OFF position.

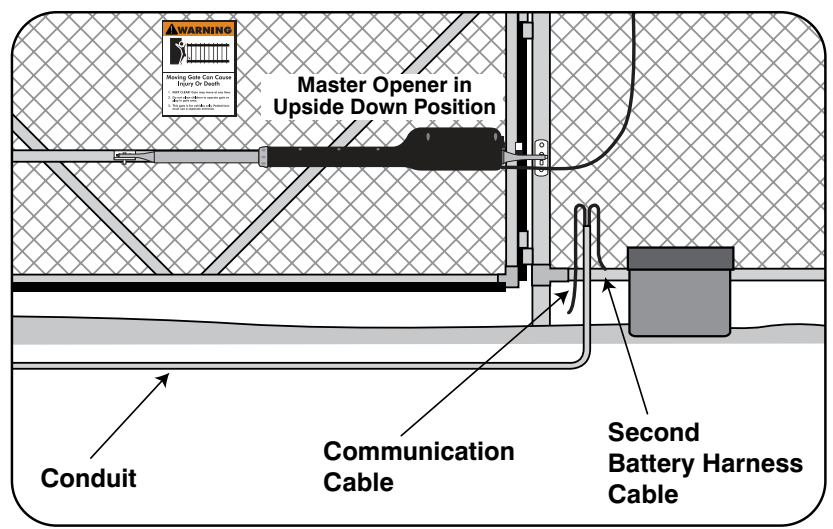

Attaching Second Opener Battery and Communication Cables

Step 1

With the SECOND opener mounted in the upside down position remove the Control Board Access Panel on the bottom of the opener arm.

Step 2

Connect the Communication Cable coming out of the conduit from the Master Opener to the LINK terminal on the second opener arm control board. Be sure to leave enough slack in the cable to accommodate routing of cable through access panel.

Step 3

Run the end of the Second Battery Harness Cable up to the Second Opener and plug it into the battery harness terminal on the control board. **DO NOT** connect the other end of the Battery Harness cable at this point.

Step 4

IMPORTANT: Make sure the power switch on the opener arm is in the OFF position.

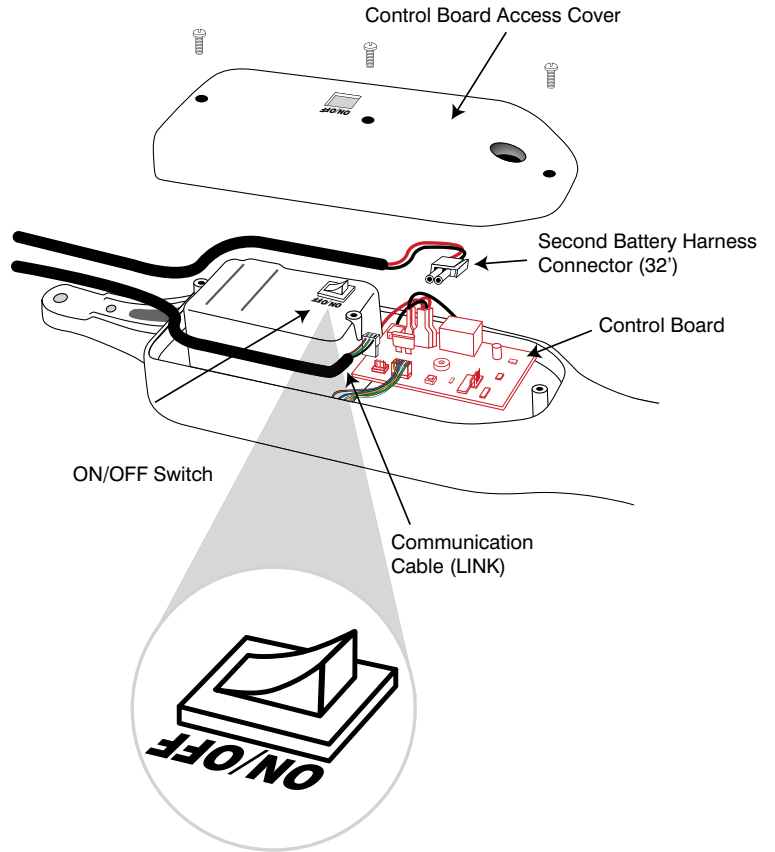

At this point your gate openers should be connected like the picture below.

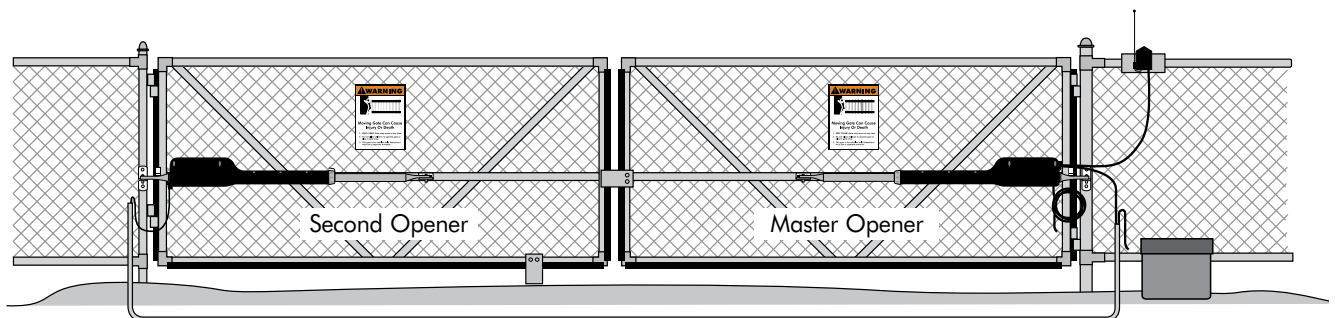

Powering Options: Transformer or Solar

IMPORTANT:

- The Mighty Mule 352 is designed and intended for use with a 12 Volt automotive or marine type battery. The battery must be placed inside a weatherproof case and located within 6 feet of the opener arm. The 10 foot harness supplied connects the battery to the master arm.
- The battery charge is maintained by the 18 Volt transformer included **or** by using optional solar panel(s). The transformer **or** solar panel is connected to the opener arm control board using low voltage, 16 gauge, dual conductor, multi-stranded, direct burial wire (RB509) (see page 24 and the Accessory Catalog).
- All low voltage wire used with the Mighty Mule® 352 Gate Opener must be 16 gauge dual conductor, multi-stranded, direct burial wire (see page 24 and the Accessory Catalog). **Do not run more than 1000 feet of wire.**
- The transformer is designed and intended for indoor use. If the transformer can be plugged only into an outside electrical outlet, a weatherproof cover or housing (available at local electrical supply stores) **must** be used.
- If your gate is more than 1000 ft. from an ac power source, you will need to use at least one 10 watt Solar Panel to charge the battery (see Accessory Catalog). Refer to the **Solar Panels and Gate Activity** chart below.

NEVER USE TRANSFORMER AND SOLAR PANEL(S) AT THE SAME TIME
– it will damage the control board –

Solar Panel and Gate Activity Chart

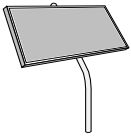

The table and map illustrate the maximum number of gate cycles to expect per day in a particular area when using from 10 to 30 watts of solar

charging power. (see Accessory Catalog). The figures shown are for winter (minimum sunlight) and do not account for the use of any accessory items.

Accessories connected to your system will draw additional power from the battery and will require additional solar panels.

*** Use up to 250 feet of 16 AWG wire to place solar panel in a good location.**

Winter Ratings	Zone 1	Zone 2	Zone 3
12 v dual gate (10 watts) solar charger	4	8	13
12 v dual gate (15 watts) solar charger	7	13	20
12 v dual gate (20 watts) solar charger	10	18	27
12 v dual gate (25 watts) solar charger	13	23	34
12 v dual gate (30 watts) solar charger	16	28	41

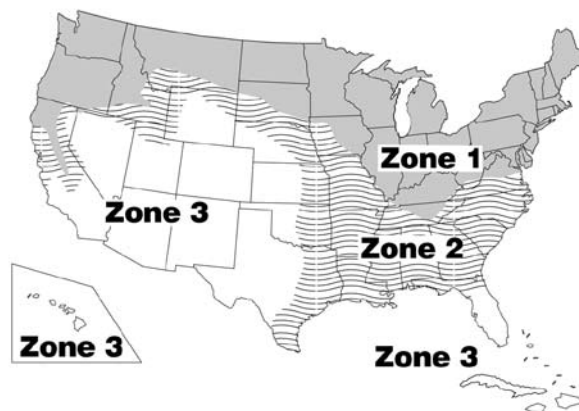

Connecting The Battery

Attach the 10 foot battery harness wires provided, to the terminals of the battery. Take care to attach the BLACK wire to the NEGATIVE terminal and the RED wire to the POSITIVE terminal. Reverse connection will cause damage to the control board.

IMPORTANT: Make sure the power switch on the both opener arms is in the OFF position

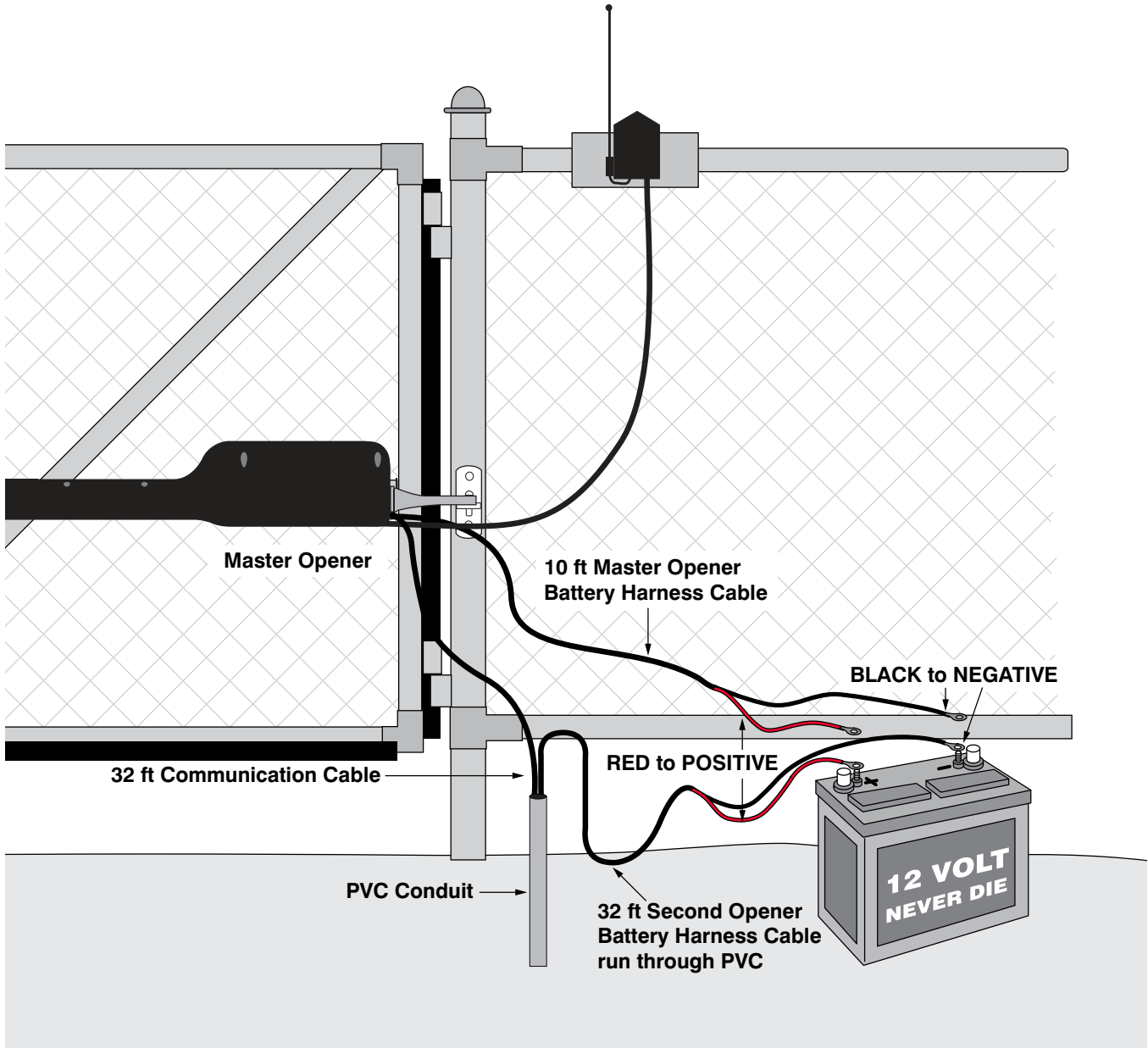

Connecting the Transformer

IMPORTANT: Never connect the transformer and a solar panel to the opener control board at the same time. It will damage the control board.

If you are using SOLAR PANEL(S) to charge the opener battery, skip this section and go to "Connecting Solar Panel(s)" section on page 26.

IMPORTANT INFORMATION ABOUT LOW VOLTAGE WIRE

The only wire acceptable for use with GTO products is 16 gauge multi-stranded, low voltage, PVC sheathed wire. This particular gauge enables the transformer to provide an adequate charge through the control board to the battery at distances up to 1000 ft.

DO NOT use telephone wire or solid core wire. Unlike multi-stranded wire, these types of wire are inadequate for use with your gate opener system. Telephone wire and solid core wire do not deliver enough voltage for your gate opener to function and will cause the system to go into a condition known as "low voltage lockout."

NEVER splice wires together. Splicing permits corrosion and seriously degrades the wire's ability to carry an adequate current.

Step 1

Select the 120 Volt electrical outlet into which you will plug the transformer. Lay the low voltage wire in a trench following a path from the selected electrical outlet to the control box. Wires coming up from the ground should be run through PVC conduit to protect them from lawn mowers, weed eaters, and grazing animals. Be sure to bury the wire laid in the trench.

Step 2

Bring enough wire up through the PVC conduit to allow for gate movement from open to closed position. See example right.

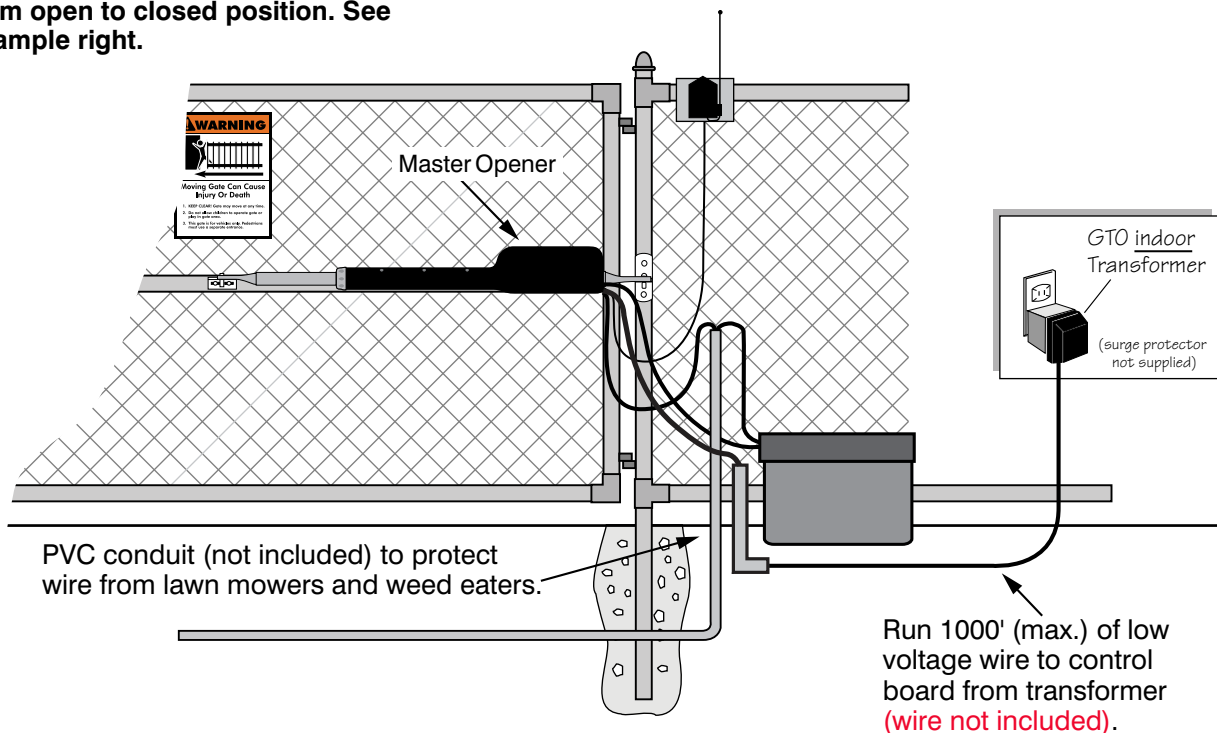

Step 3

Strip $\frac{3}{16}$ " off the ends of the low voltage wire and twist tightly. Insert these ends to the **18 VAC** terminal block located on the control board (see illustration at right). The wires can be inserted into either terminal regardless of color. **Be certain not to let the exposed wires touch each other!**

Tighten set screws against exposed end of wires. A dab of household petroleum jelly on each terminal will help prevent corrosion.

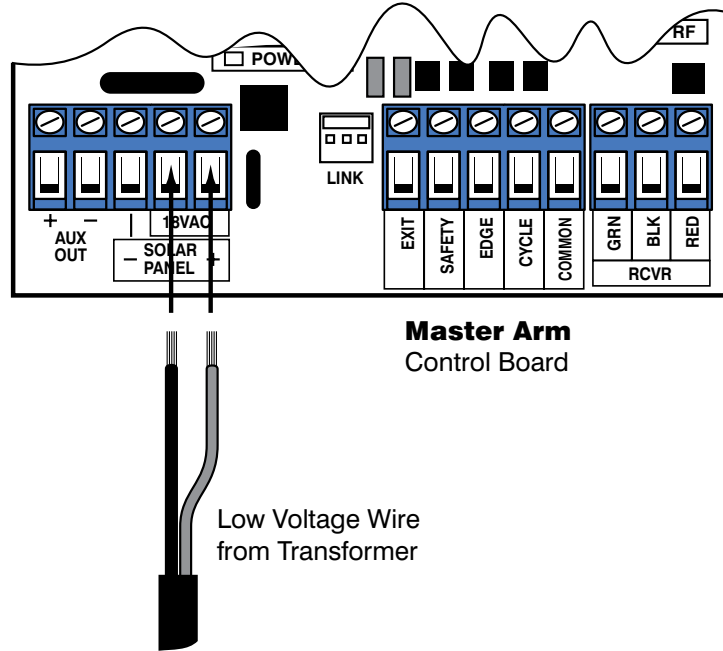

Step 4

At the AC outlet strip $\frac{1}{2}$ " of insulation from the ends of the low voltage wire. Attach these stripped ends to the transformer terminals.

A dab of household petroleum jelly on each terminal will help prevent corrosion.

We suggest crimping a spade tongue terminal (not provided) to the end of each wire before attaching it to the transformer.

Make sure the exposed wires do not touch each other!

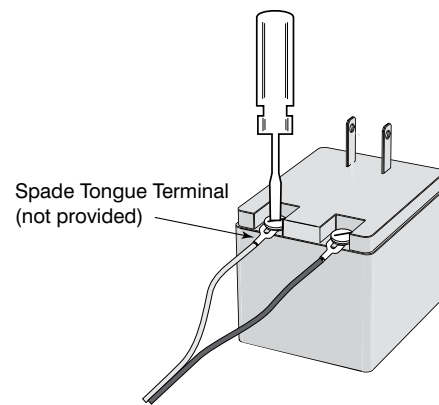

Step 5

Plug the transformer into the electrical outlet. (Use of a surge protector with the transformer is **strongly** recommended - not included) If electrical outlet is located outdoors, outlet and transformer should be protected by a weatherproof cover.

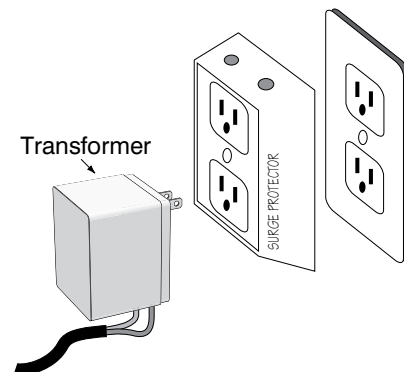

Connecting Solar Panel(s)

IMPORTANT: Never connect the transformer and a solar panel to the opener control board at the same time. It will damage the control board.

If you are using the transformer included with the Mighty Mule 352 to charge the opener battery, skip this section and go to "MASTER CONTROL BOARD SETTINGS" below.

Strip $\frac{3}{16}$ " off the ends of the low voltage wire from the solar panel and twist tightly. Attach the **RED solar panel wire** to the **SOLAR terminal marked (+)** and the **BLACK solar panel wire** to the **SOLAR terminal marked (-)** on the **MASTER** control board.

Tighten set screws against exposed end of wires. A dab of household petroleum jelly on each terminal will help prevent corrosion.

NOTE: For multiple panels wire the panels in parallel as shown in this diagram.

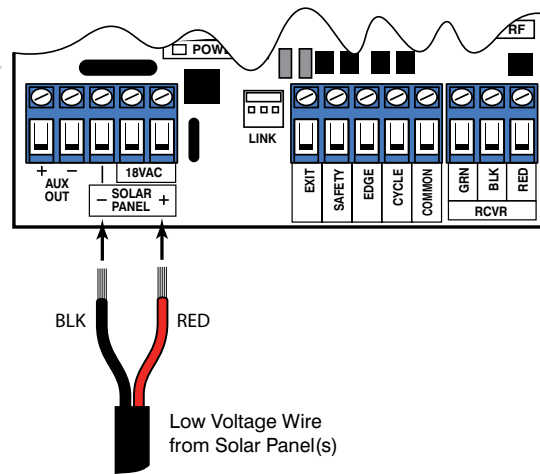

Solar Panels connect in **PARALLEL**

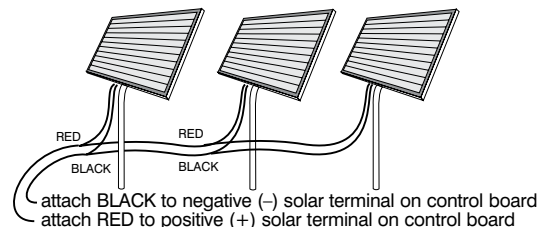

Master Control Board Settings

DIP Switches

Main DIP Switch Settings (MODES)

DIP Switch #1 - Push/Pull-to-Open

If your gates open into the property the DIP Switch is set to OFF (factory default). If your gates open out from the property the DIP Switch must be set to the ON position. NOTE: if you have a Push-to-Open gate application you will need Push-to-Open brackets (see Push-to-Open Instructions on page 36).

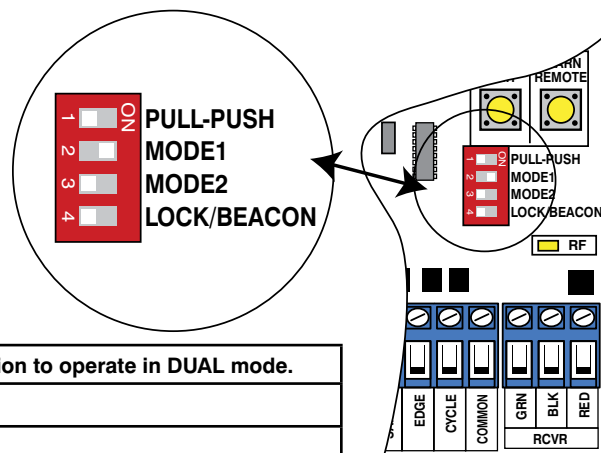

MODE 1	MODE 2	* MODE1 or MODE 2 must be in the ON position to operate in DUAL mode.
DIP #2	DIP #3	Dual Mode Sequence
OFF	OFF	Single Gate Mode
ON	OFF	MASTER opens 1st, SECOND opens 2 seconds later. SECOND closes 1st, MASTER closes 4 seconds later. (factory)
OFF	ON	MASTER opens 1st, SECOND opens 2 seconds later. SECOND closes 1st, MASTER closes 8 seconds later.
ON	ON	MASTER and SECOND simultaneously open and close.

DIP Switch #4 - Lock/Beacon

This DIP selects the mode of operation of the "AUX OUT" terminal. The OFF (factory) setting is selected when the Mighty Mule Automatic Gate Lock is used with the Mighty Mule 352. The RED wire from the lock is connected to the "AUX OUT +" terminal and the BLACK wire from the lock is connected to the "AUX OUT -" terminal. Factory default-(OFF position provides a timed pulse of voltage to the accessory while the gate opener is activated). Lock and circuit board will be damaged if #4 is on.

The ON setting is selected when a beacon or light is used with the Mighty Mule 352. One wire from the low voltage beacon or light is connected to the "AUX OUT +" terminal and the other to the "AUX OUT -" terminal. (ON position provides a continuous voltage to the accessory while the gate opener is activated).

Important: Make sure your light or beacon is a 12Vdc system that draws less than 2 amps or less than 25 watts.

Stall Force Potentiometer Setting

IMPORTANT: For safety reasons the obstruction setting or **Stall Force** on the Mighty Mule® 352 control board comes from the factory set at **MIN** (minimum). In many gate installations this setting will need to be adjusted to overcome the weight and size of the gates.

The **Stall Force** potentiometer on the control board operates like a volume control on a radio. It controls the obstruction sensitivity (or the amount of force the opener will apply to an obstruction) before it automatically stops and reverses direction for approximately two (2) seconds.

Use a small slotted screwdriver to turn the arrow in the center of the potentiometer. Adjust the sensitivity from the MINIMUM position where the gate operates without obstructing from its own weight or the wind conditions in your area.

NOTE: You may need to increase the stall force in cold weather due to increased resistance from gate hinges.

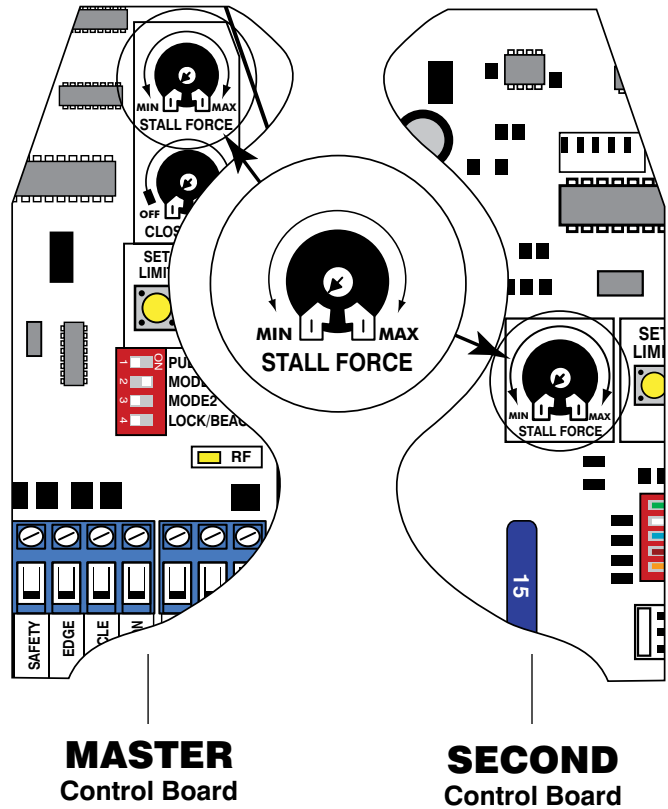

ALWAYS KEEP SAFETY AT THE TOP OF YOUR LIST WHEN ADJUSTING OR SERVICING YOUR AUTOMATIC GATE OPENER!

Setting Auto-Close Time

MASTER ARM CONTROL BOARD ONLY

CLOSE TIME (auto close timer): Determines how long the gate will remain open before it automatically closes. The limits are **OFF** to **120 seconds**. The factory setting is the **OFF** position.

Note: Gate will **NOT** automatically close unless both gates are at the fully open position regardless of the auto-close timer setting.

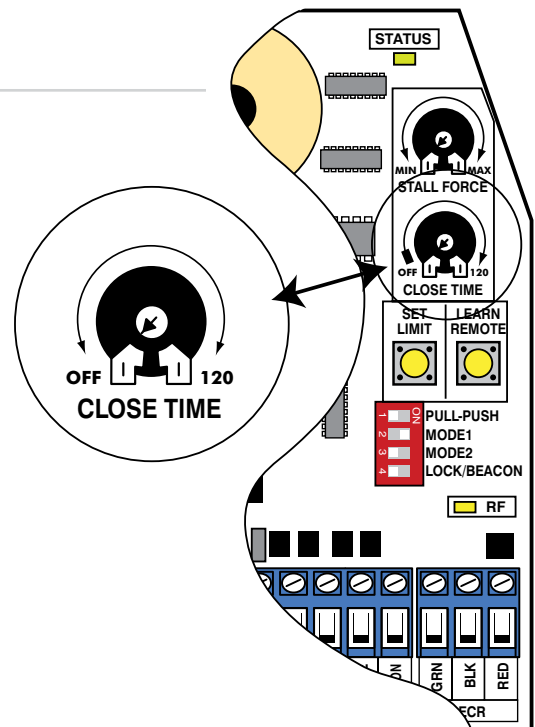

Installing the Receiver

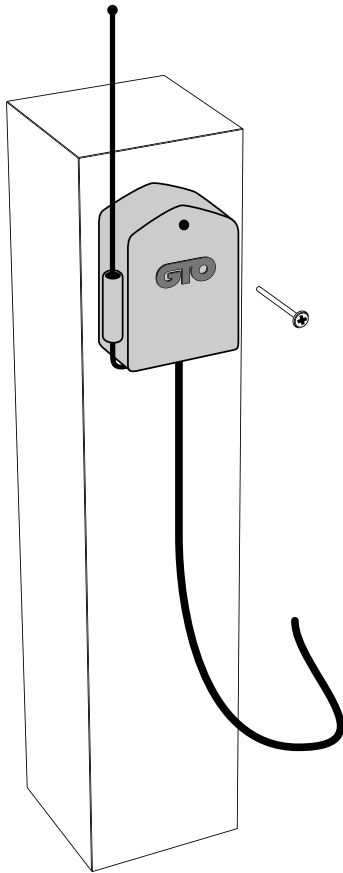

Use the transmitter to check the range of the receiver before permanently mounting it.

Consider the following when mounting the receiver:

- Standard receiver cable length is 10 feet (receivers with a longer cable are available as special order items; *call the GTO Sales Department*). NEVER splice receiver cable!
- **Run the cable through PVC conduit to protect it from damage.**
- DO NOT run cable through metal conduit because the receiver signal range will be decreased.
- DO NOT coil excess cable or store it in the control box.
- DO NOT run cable in conduit containing ac wiring.
- The receiver range can vary from 50 to 100 feet depending upon weather, topography, and external interference.

NOTE: Do not mount upside down.

FCC Regulation

This device complies with FCC rules Part 15. Operation is subject to the following conditions:

1. This device may not cause harmful interference.
2. This device must accept an interference that may cause undesired operation.

Transmitter distance may vary due to circumstances beyond our control.

NOTE: The manufacturer is not responsible for any radio or TV interference caused by unauthorized modifications to this equipment. Such modifications could void the user's authority to operate the equipment.

Setting the Closed Position Limit

*** NOTE:** You may need to set the stall force slightly off of minimum depending on the size and weight of the gate.

For PULL-TO-OPEN Installation
Turn the power switches on the opener arms to the ON position

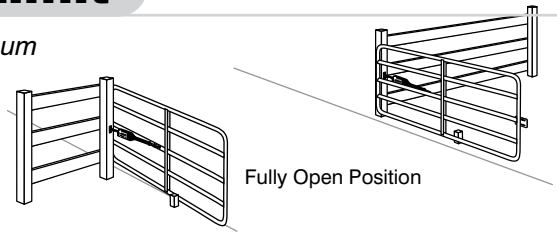

Fully Open Position

Your Mighty Mule 352 has two Limit Settings

1) **OPEN Limit setting:** (gates in the OPEN POSITION / FACTORY SET & NOT ADJUSTABLE) The open limit setting is the fully open position. At this point the arms are fully retracted.

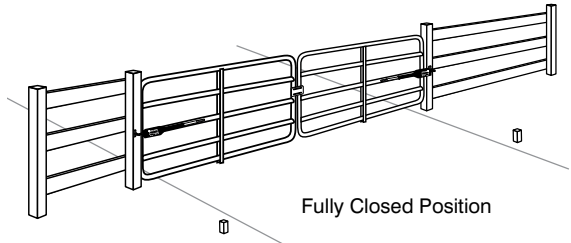

Fully Closed Position

2) **CLOSED Limit setting:**
The CLOSED Limit setting (gates in the CLOSED POSITION) To achieve optimum closed position, you are required to complete the following FOUR STEPS:

Step 1

While programming, be sure the gate is in the OPEN POSITION and the operator is mounted upside-down with "SET LIMIT" PROGRAM BUTTON visible on the control board.

Step 2

Activate your opener by pressing the entry transmitter. Your gates should now be moving from the fully open position toward the closing position. Press the transmitter again to stop the gate at the desired closed position. Note: whichever gate reached its desired closed position first that will be the first one to be programmed.

- If the second arm is stopped at the desired closed position, press the 'SET LIMIT' on the **SECOND ARM** for 5 seconds.
- If the master arm is stopped at the desired closed position, press the 'SET LIMIT' on the **MASTER ARM** for 5 seconds.

Step 3

Save the setting by pressing the transmitter and allowing the gate to return to the fully open position. YOUR CLOSED POSITION LIMIT IS NOW PROGRAMMED.

Step 4

Repeat step 2-3 for the other arm that has not been programmed in step 2.

TESTING YOUR CLOSED LIMIT SETTING:

Press your entry transmitter and allow your gate to close. If CLOSED position is not correct or needs to be changed you will need to CLEAR your CLOSED LIMIT (see below) setting and follow steps 1 through 3 again.

CLEARING PROGRAMMED CLOSED LIMIT SETTING:

If you make a mistake and set the limit at the wrong position – press your transmitter to return the gate to its fully opened position, then press and hold the "SET LIMIT" button on the corresponding arm for 5 seconds. This will clear the memory for the closed limit position. Follow Steps 1-3 again.

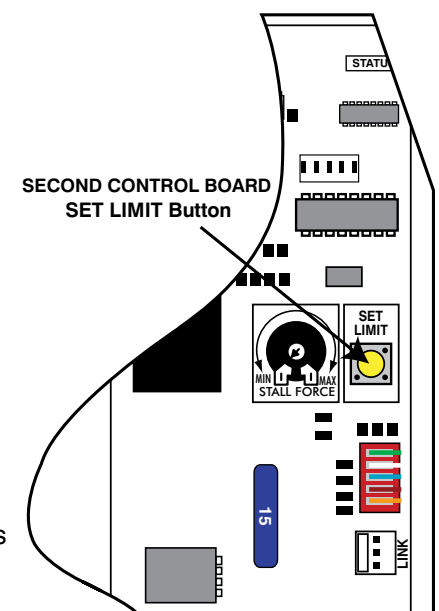
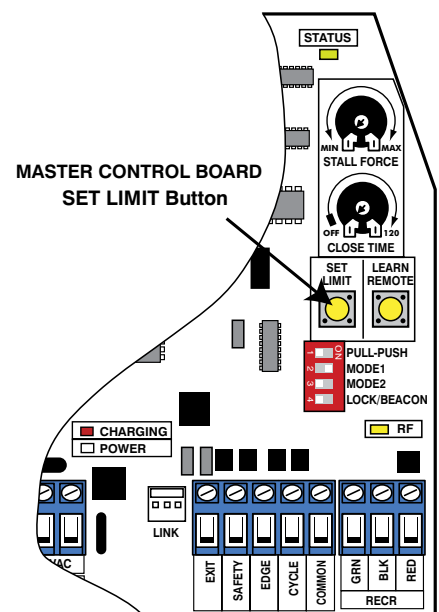

Setting Your Personal Transmitter Code

All GTO transmitters are set to a standard code at the factory and are ready to operate your Mighty Mule® 352 Gate Opener®. For your safety and security, however, we strongly recommend that you replace the factory setting with your own personal code. Follow the directions below:

1. Remove the Transmitter Cover

On the back of the transmitter use a small phillips head screw driver to remove the two screws on the sides of the visor clip and separate the front cover from the transmitter. With the front cover removed, the battery and the DIP switches will be exposed. To set a new code, use a small screwdriver to move the switches.



2. Set the transmitter DIP Switches

There are nine (9) transmitter DIP switches; each can be placed in three different positions (+, 0, -). **DO NOT** set all the switches in the same position, such as all +, all 0, or all -. Once the DIP switches have been set to a personal code, replace and close the access cover.

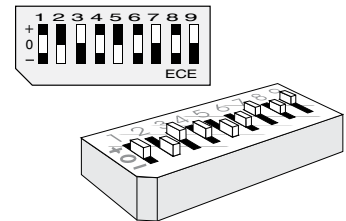

WARNING: No other adjustments should be made inside the transmitter.

3. “Teach” the New Code to Control Board Memory

- Press and hold transmitter button.
- Press and hold the **LEARN REMOTE** button on the control board until it beeps.
- Release transmitter button.
- Release **LEARN REMOTE** button. The new code is stored in control board memory.

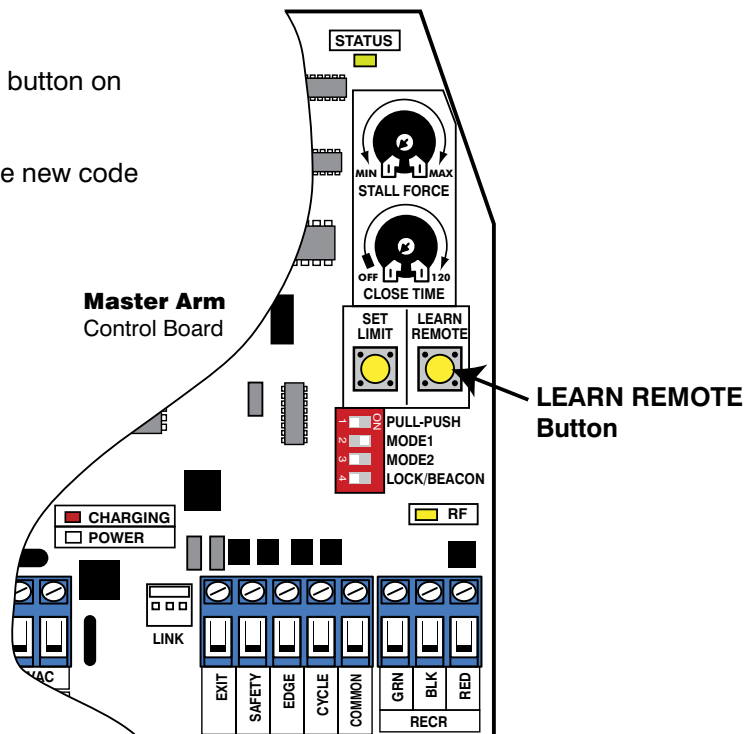

Connecting Additional Safety Devices

Although GTO strongly recommends the use of additional safety devices, we do not endorse any specific brand names. Only use products that are certified and listed to be in compliance with any applicable UL standards (Underwriters Laboratories) and national and regional safety codes.

Call GTO Sales at 1-800-543-4283 for information on compatible products for your specific application.

Control Board Connections

- LOCK OUTPUTS**
- 1 **AUX OUT (+):** (Typically for use with automatic gate lock or light)
 - Provides 12Vdc power @ a maximum of 2 Amps or less than 25 watts when the gate is in motion.
 - 2 **AUX OUT (-):** (Typically for use with automatic gate lock or light)
 - Provides 12Vdc power @ a maximum of 2 Amps or less than 25 watts when the gate is in motion.

NOTE:

- All control inputs are dry-contact, normally open, inputs. **DO NOT** apply external voltage sources to these inputs.
- All inputs are connected with respect to **COMMON** terminal.
- The status light will blink once when its corresponding input is activated.

- CHARGE POWER INPUTS**
- 3 **SOLAR PANEL (-)**
 - Input for 18-22Vdc charge power from solar panel
 - 4 **18 VAC**
 - Input for 18-22Vac charge power from transformer
 - 5 **SOLAR PANEL (+):**
 - Input for 18-22Vdc charge power from solar panel
 - Input for 18-22Vac charge power from transformer.

- ACCESSORY INPUTS**
- 6 **EXIT:** (Typically for use with exit loop or wand)
 - Activation of this input will open the gate if it's not already at the open position
 - Activation of this input while at open limit will restart the auto close time (if enabled).

- 7 **SAFETY:** (Typically for use with photo beam device, loop detector or other non-contact sensors)
 - Activation of this input while the gate is closing will cause the gate to stop and return to the opened position.
 - Activation of this input while the gate is opening has no effect (gate will continue to open).
 - Activation of this input while gate is idle will prevent gate from closing.

- 8 **EDGE:** (Typically for use with safety edge device or other contact sensor)
 - Activation of this input while the gate is operating will cause the gate to stop and reverse direction for approximately 2 seconds.
 - Activation of this input while gate is idle will prevent gate from opening or closing.

- 9 **CYCLE:** (Typically for use with doorbell button or hardwired keypad)
 - Each activation at this input will cycle the operation as follows:
.... OPEN STOP CLOSE STOP OPEN ...

- 10 **COM:** Circuit common (reference for all logic input)
 - Two (2) terminals to provide extra common connection point.

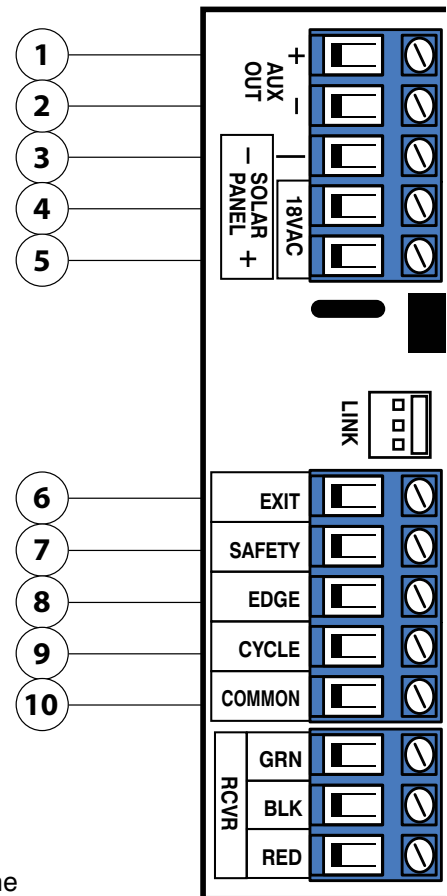

Connecting Accessories

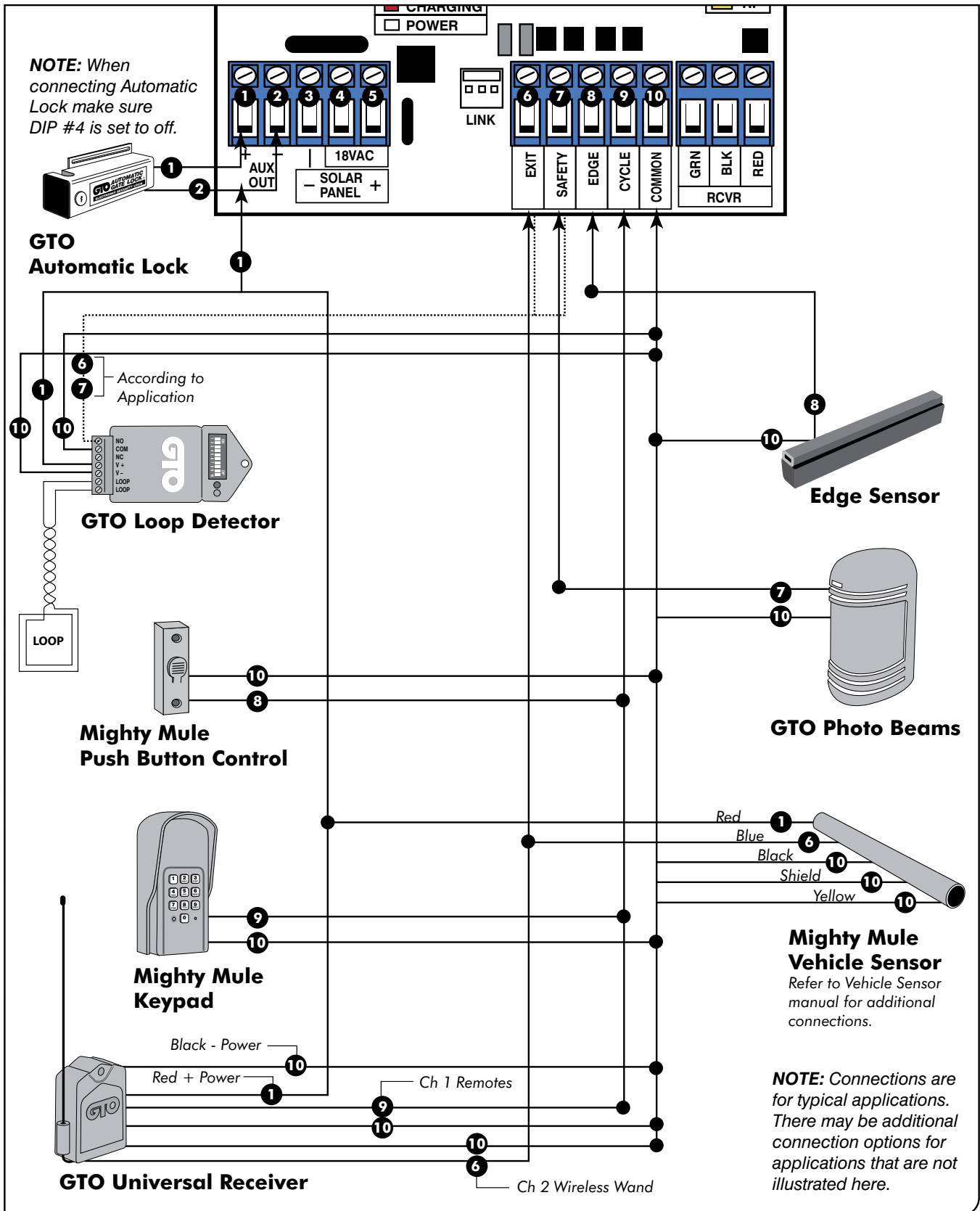

Routing Wires Through The Access Panel

Master Opener

The master opener's battery harness wire has an in-line 20 Amp fuse that must be placed inside the opener prior to closing the access panel. The illustration to the right shows the best placement for the battery harness wire, connector and in-line fuse, communication cable, receiver wire, transformer or solar panel and any accessories that have been installed. All wires must be routed down the sides of the opener and flatly out the slot in the back of the opener.

It is IMPORTANT that the wires lay flat and run inside the routing pins at the back of the opener and out the slot without being pinched when the control board access cover is replaced. See the illustrations to the right and below.

Mighty Mule 352 Master Opener Wire Routing

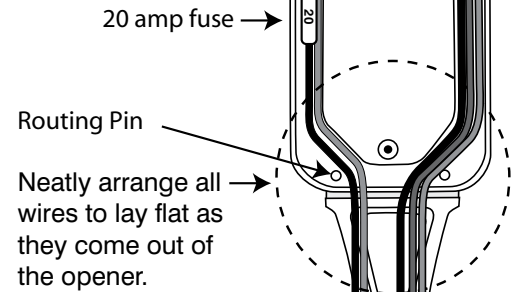

Second Opener

The battery harness and communication cable must be routed down the sides of the opener and flatly out of the slot in the back of the opener.

It is IMPORTANT that the wires lay flat and run inside the routing pins at the back of the opener and out the slot without being pinched when the control board access cover is replaced. See the illustrations to the right and below.

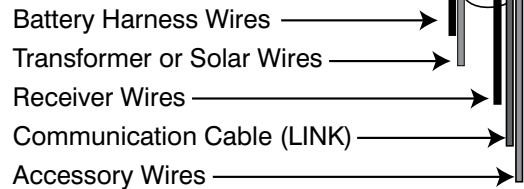

Mighty Mule 352 Second Opener Wire Routing

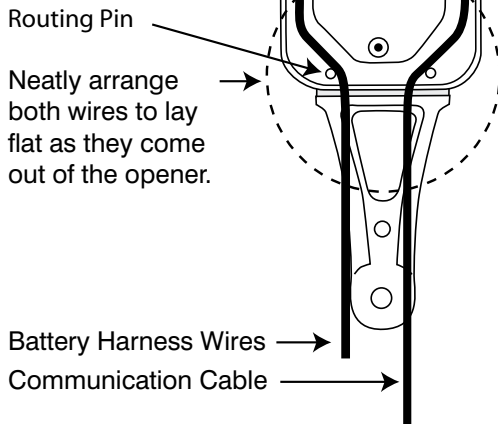

To avoid stripping screw holes - tightening screws by hand with a hand held screwdriver is recommended.

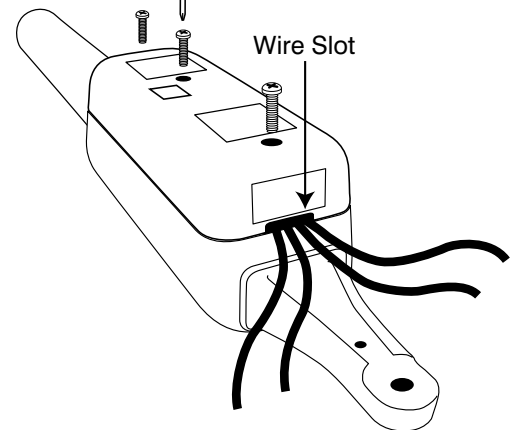

If you have any questions please call GTO Technical Service at 1-800-543-1236.

Final Step

When everything has been connected to the opener...

Replace the control board access cover. If you were working with the opener with the control board access facing up, remove the opener arm from both mounts and remount it in the upright position (control board cover facing down). Failure to remount opener in the upright position will allow water to enter the opener and cause damage to the opener control board.

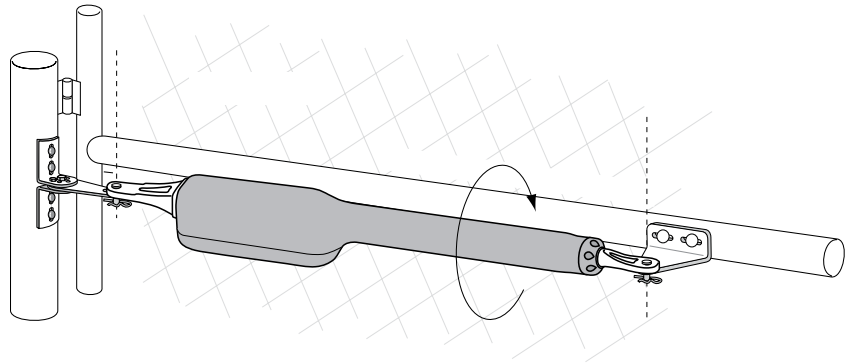

Push to Open Installation

Determining The Mounting Position of The Post Bracket Assembly

⚠ Swinging gates shall not open into public access areas!

"Push-to-Open" gates open *out* from the property. **Push-to-Open Brackets are required for this type of installation** (see *Accessory Catalog*). If you have pull-to-open gates (gate opens *into* the property), return to page 13; step 3.

In a PUSH-TO-OPEN installation the opener is installed while the gate is in the **closed** position.

Step 1

With the gate in the closed position (up to 110° from its open position), and the opener fully retracted, adjust the post bracket assembly and gate bracket until the opener is level. While holding the opener level, use C-clamps to **temporarily** keep the post bracket assembly and gate bracket in their respective positions on the fence post and gate.

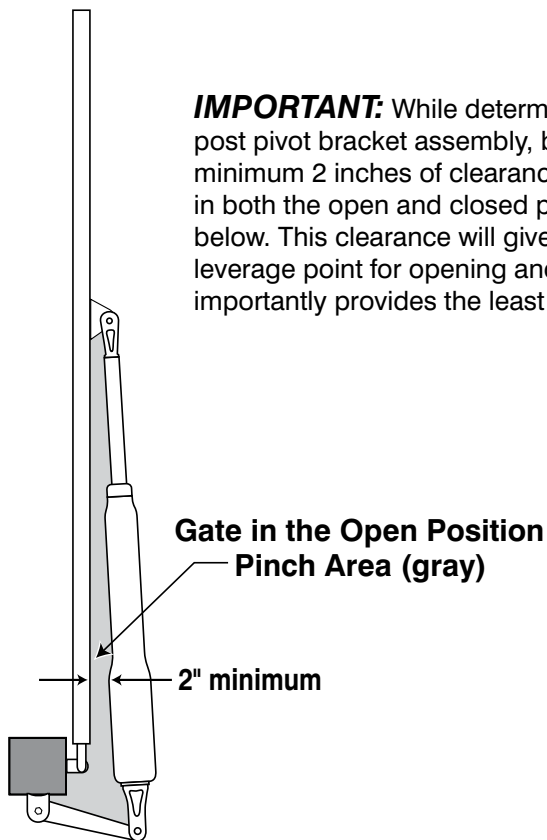
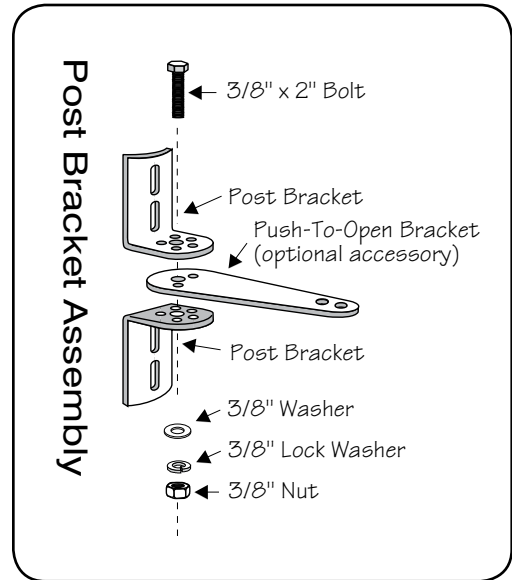

IMPORTANT: While determining the mounting point for the post pivot bracket assembly, be sure that the position allows for minimum 2 inches of clearance between the gate and the opener in both the open and closed positions, as shown in the diagrams below. This clearance will give the opener the most efficient leverage point for opening and closing the gate and more importantly provides the least possible pinch area.

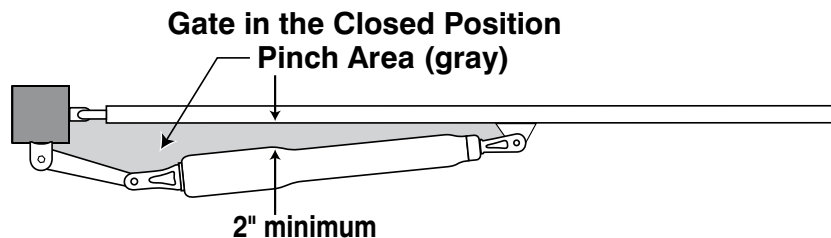

Step 2

After verifying that you have the best position for the post pivot bracket, insert the 5/16" x 1 3/4" bolt through the aligned holes of the post bracket and post pivot bracket and fasten it with the 5/16" washer and nut.

IMPORTANT: If you loosened the clamp on the post bracket to achieve the optimum position, tighten it in its new position and recheck the gate bracket with the gate in the open position (move the gate bracket and re-clamp it if necessary).

Step 3

With the gate in the **fully closed position** and the opener retracted, swing the opener to the gate. Mark reference points for bolt holes on gate cross member through middle of gate bracket slots. The opener must be level. (Some vertical adjustment is possible by sliding the post bracket assembly up and down.) Drill $\frac{3}{8}$ " holes into the gate cross member as marked. Fasten gate bracket to cross member using (2) $\frac{3}{8}$ " x 3" bolts, washers, lock washers, and nuts. Attach the opener to the post bracket assembly and gate bracket using clevis pins, bushings, and hairpins clips.

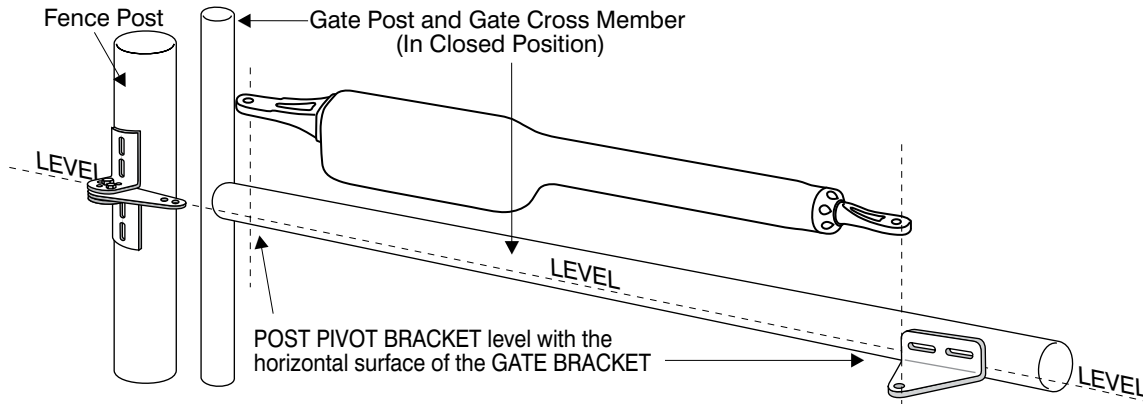

Step 4

Make sure the control box power switch is **OFF**. Use a small screwdriver to move the **Number 1** DIP switch from the factory setting (OFF / Pull-To-Open) to **ON for Push-To-Open**. Turn power switch **ON**. The control board is now configured to *push* the gate open.

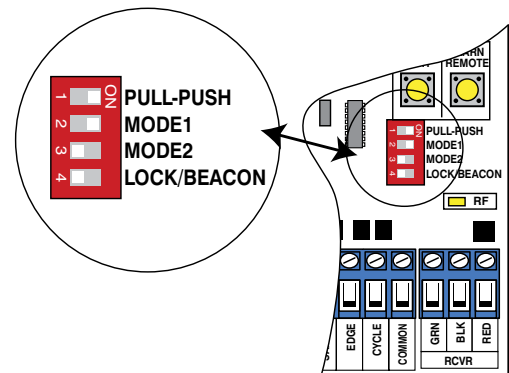

Setting the Open Position Limit

Step 1

Confirm that the power switch is in the ON position, and the gate is in the CLOSED POSITION.

Step 2

Activate your opener by pressing the entry transmitter. Your gates should now be moving from the fully CLOSED POSITION toward the opening position. Press the transmitter again to stop the gate at the desired OPEN position. Note: whichever gate reached its desired open position first that will be the first one to be programmed.

- If the second arm is stopped at the desired open position, press the **'SET LIMIT'** on the **SECOND ARM FOR 5 SECONDS**.
- If the master arm is stopped at the desired open position, press the **'SET LIMIT'** on the **MASTER ARM FOR 5 SECONDS**.

Step 3

Save the setting by pressing the transmitter and allowing the gates to return to the fully closed position. YOUR OPEN POSITION LIMIT IS NOW PROGRAMMED.

Step 4

Repeat step 2-3 for the other arm that has not been programmed in step 2.

TESTING YOUR OPEN LIMIT SETTING:

Press your entry transmitter and allow your gate to open. If OPEN position is not correct or needs to be changed you will need to CLEAR your OPEN LIMIT (see below) setting and follow steps 1 through 3 again.

CLEARING PROGRAMMED OPEN LIMIT SETTING:

If you make a mistake and set the limit at the wrong position – press your transmitter to return the gate to its fully closed position, then press and hold the "SET LIMIT" button for the corresponding arm for 5 seconds. This will clear the memory for the open limit position. Follow Steps 1-3 again.

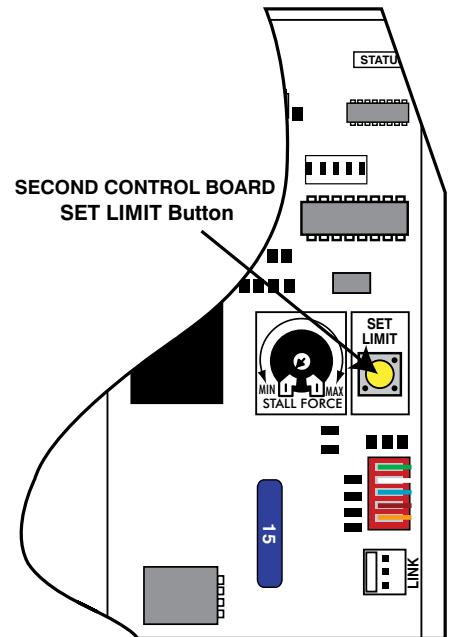
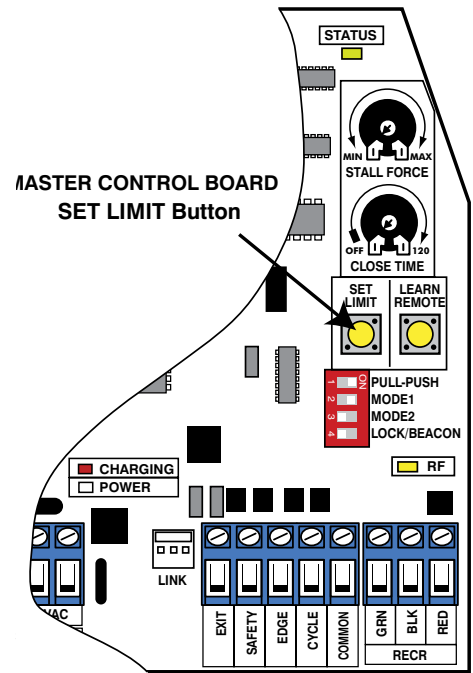

Visual and Audible Diagnostic Indicators

If your gate opener does not function properly after it is installed, use this guide or use the **online troubleshooter** at <http://support.gtoinc.com/support/troubleshooter.aspx> before calling the GTO Service Department.

- On all gates weighing 250 lb. or more, routinely grease the ball bearing hinges at least 4 times a year; more frequently if the gates are in a coastal area.
- Clean the push-pull tube with a soft, dry cloth and apply silicone spray to it at least once a month.
- While oxidation is a normal part of weathering of equipment that is exposed to the elements, we recommend you apply silicone spray the front and rear mounts to minimize this effect.

Audible/Buzzer/Alarm Feedback:

1. 1 beep with 2 seconds off:

Limit switch error: Limit switch's normally open and normally close inputs both open or both shorted. Circuit board is indicating faulty limit switch inside the operator. The alarm will automatically shut off in 4 seconds after the problem is corrected. Call Tech Support.

2. 5 beeps with 2 seconds off:

Low battery condition detected:

- Check battery voltage to ensure you have 12.5 to 13.5 Vdc
- Check transformer output to ensure you have 18-22 Vac
- Check charging circuit with transformer or solar panel connected to ensure battery is being charged to 13.8 to 14.8 vDC. Battery may be charged with a trickle charger at 12Vdc 2 amps for 3 to 4 hours but be sure to disconnect it from the system.

3. 1 beep when attempt to run the unit:

- Blown fuse
- Dead cell or extremely low battery condition.
- Bad connection from battery to circuit board.

4. Alarm continuously beeps (remote does not operate unit AND not at either limits):

- Two consecutive obstructions have been detected without reaching the limit. Alarm will automatically shut off after 5 minutes. 'Power-cycle' the unit will also shut off the alarm.
- The battery may be extremely low.

5. Learn Remote: (MASTER ARM ONLY)

When a new code is learned from the remote the alarm will sound. Release the 'LEARN REMOTE' button will turn the alarm off. See "Setting Your Personal Transmitter Code" section on page 30.

6. Power-Cycle:

The alarm will beep for 1 second upon power up to indicate the opener is ready to operate.

Visual/LEDs Feedback:

1. RF LED (LED2): (MASTER ARM ONLY)

Blinking when there is 318 MHz signal is received. This LED is typically off when the receiver is connected and no 318 MHz signal is presented.

If no light:

- a. Check receiver connection on the control board
- b. Replace the battery in the remote.
- c. Relocate antenna
- d. Re-learn the remote

2. STATUS LED (LED1):

While the unit is IDLE:

1 blink with 2 seconds off:

Free Exit terminal is shorted to common. Check exit wand or loop detector.

2 blink with 2 seconds off:

Safety terminal is shorted to common. Check photo beams or loop detector.

3 blink with 2 seconds off:

Edge terminal is shorted to common. Check edge sensor.

4 blink with 2 seconds off:

Cycle terminal is shorted to common. Check push button, wired keypad or wired intercom.

LEARN LIMIT Mode:

This LED will turn on when the 'SET-LIMIT' button is pressed. It will turn off after 3 seconds indicating that it has entered the learn limit mode (if not at the retracted limit) or cleared the previous learned limit (if at retracted limit). See "Setting Closed Position" section on page 27.

Whenever there is a change in state at any of the inputs this LED will blink once.

3. POWER LED (Green): (MASTER ARM ONLY)

ON: AC power or solar power is present.

OFF: NO AC power or solar power is present.

4. CHARGING LED (Red): (MASTER ARM ONLY)

Continuously ON: Fast charging mode. (~1.5 Amps charging current). 14.8 Vdc Blinking (two blinks per second): Soak charge. Enter this mode after fast charging. The battery is almost at full charge in this mode. 14.2 Vdc Slow blinking (one blink per second): Float charge. In this mode when the battery is fully charged. 13.8 Vdc

The Gate CLOSES Then Opens Again on its Own:

1. Check the position of the pivot and post brackets and readjust if necessary.
2. Check the gate for binding or hinge damage.
3. Reset closed position limit.
4. Adjust stall force.

The Gate OPENS Then Closes Again on its Own:

1. Check the position of the gate brackets and readjust if necessary. Take opener off gate. Retract tube with remote. Re-attach arm to see if hole in front mount aligns with hole in gate bracket.
2. Check the gate for binding or hinge damage.
3. Adjust stall force.

VOLTAGE RATINGS

18 Vac Transformer _____ 18.0 to 22.0 Vac

10 W Solar panel (single) _____ 18.0 to 22.0 Vdc 600 mA
measure voltage at panel and control box.

12 V Battery _____ 12.5 to 13.5 Vdc

Charging circuit _____ 13.8 to 14.8 Vdc
measure voltage with battery connected

Repair Service

If your Mighty Mule® 352 Gate Opener is not operating properly, please follow the steps below:

1. First use the procedures found in the **Visual and Audible Diagnostic Indicators** section (see page 39).
2. Use the Online Troubleshooter at **<http://support.gtoinc.com/support/troubleshooter.aspx>**.
3. If you are unable to solve the problem, call the **GTO Service Department** at (800) 543-1236, or (850)575-4144. Refer to the serial number (located on the back of opener arm) and date of purchase when calling for assistance.
4. If repair or replacement of your gate opener is necessary, the Service Department will assign a **Return Goods Authorization (RGA) number** to you for all warranty repairs
5. Securely pack the component(s) authorized for return to the factory. Include a copy of your receipt for proof of purchase. Write the RGA number issued to you on the outside of the package in **LARGE BOLD PRINT**. Ship the package(s) freight prepaid to:
GTO, Inc., 3121 Hartsfield Road, Tallahassee, Florida, USA 32303.

NOTE: Products returned to GTO without a Return Goods Authorization (RGA) number in LARGE BOLD PRINT on the outside of the package WILL NOT be accepted. Also, items returned to GTO freight collect WILL NOT be accepted.



For more information on Mighty Mule's full line of Automatic Gate Openers and Access Controls visit our website at www.mightymule.com

**For 24 hour/day, 7 day/week Technical Service visit
<http://support.gtoinc.com/support/troubleshooter.aspx>**

The GTO, Inc. Technical Service Department is open
Monday – Friday 8:00 A.M. – 7:00 P.M. (Eastern Time)
1-800-543-1236

For sales call toll free:
1-800-543-GATE (4283)

GTO, Inc.
3121 Hartsfield Road • Tallahassee, Florida, USA 32303 • (850) 575-0176
Fax (850) 575-8912 • www.mightymule.com

Column Installation Information

IF THIS OPENER WILL BE USED WITH GATES THAT ARE MOUNTED ON MASONRY, BRICK, OR ROCK (etc.) COLUMNS:

READ THE FOLLOWING CAREFULLY BEFORE PROCEEDING

- A. The simplest solution is to install the opener in a push-to-open configuration (requires Push-To-Open Bracket, see Accessory Catalog). The minimum clearance is easier to achieve and clearance is no longer a problem, since the opener will be pushing the gate away from the column instead of pulling it toward the column. It is recommended that you place a steel plate between the opener mounting brackets and masonry surface for additional strength.
- B. If a push-to-open installation is impossible due to traffic hazards, terrain, etc., another option is to re-hang the gate. You may hang it on a post, either in the center of the column or at the back corner, or move the gate to the back corner of the columns.
- C. The most difficult solution is to cut a notch in the column to accommodate the opener and power cable. This job is **NOT** for the inexperienced!

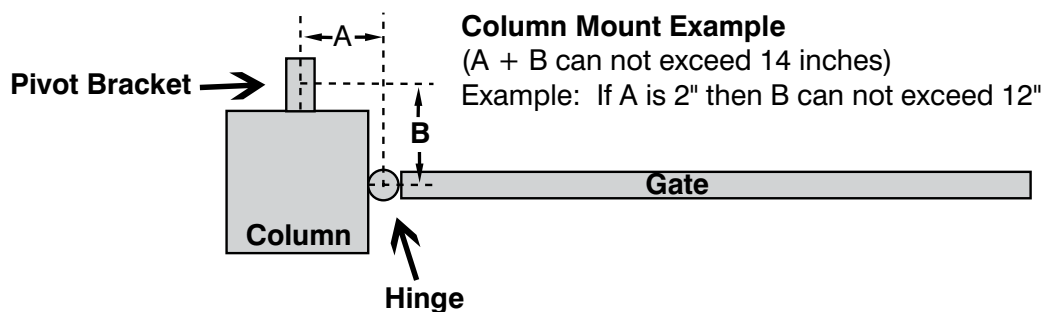



ACCESSORIES

Accessories are Available From Your Retail Store

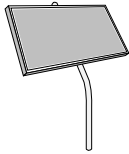

Solar Panel (FM123) 10 watt (FM121) 5 watt - requires two - 5 watt panels
 The **Solar Panel** is a 10 watt solar powered battery charger for use with the **FM350 & FM352** gate operator systems. Particularly suited for remote installations, each **Solar Panel** comes with tubular steel support, mounting clips, wire connectors, and 8 ft. of low voltage wire (see Low Voltage Wire for additional wire). The **Mighty Mule® 352** control board has clearly labeled terminal connections for easy installation of the **Solar Panel**. Installation in some regions of the world will require multiple solar panels for adequate charging power. Dual gates require a minimum of 10 watts of solar charging power. (5 watt panels require 2 panels)



Push Button Control (FM132)
 Unlit doorbell button for remote entry or exit control. Wires directly to the control board and uses 16 gauge multi-stranded, dual conductor low voltage wire (sold separately).

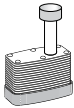

Pin Lock (FM133)
 The **Pin Lock** substitutes for the clevis pin at the front end of the **Mighty Mule® 352** gate openers. Helps prevent theft of the operator from the gate, while allowing quick release of the operator.



Key Chain Two Button Transmitter (FM134)
 The **Key Chain Transmitter** is a dual button version of the **Mighty Mule®** single button entry transmitter and has the same adjustable code settings. Used for 2 gates or 1 gate and garage door. (battery is included)



Single Button Transmitter (FM135)
 The **Mighty Mule®** entry transmitter, with adjustable code settings, is standard equipment with all **Mighty Mule® 352** systems. (battery is included)

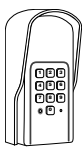

Digital Keypad (FM137)
 The specially designed digital keypad can be easily installed as a wireless or wired keypad. It can be programmed to use up to 25 different personal identification number (PIN) codes. Each code is face programmable with additional security features built in. Wired installations require 16 gauge, low voltage, multi-stranded, dual conductor, direct burial wire (sold separately). Requires 3 AA batteries (not included).



Mounting Post (FM100) - In Ground
 This black powder coated pedestal is designed to provide convenient access to your keypad, wireless intercom, or other access control device from your vehicle. With its break down design it is easy to install and works well in most standard applications. Surface Mount Flanges (F102) and Extensions (F103) for added height are available.

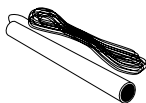

Mighty Mule® Vehicle Sensor (FM138)
 The **Gate Opening Sensor** is designed for residential and agricultural applications and is compatible with most **Mighty Mule®** automatic gate opener models (see **Sensor Box** for model compatibility). The **Sensor** is an electromagnetic sensor, which offers 'hands free' operation of the **Mighty Mule®** Gate Operator with a 12 ft. radius of detection of vehicles in motion. *A wireless version of the Gate Opening Sensor is available. (FM130)*



Accessories are Available From Your Retail Store (con't)

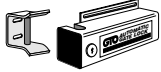

Automatic Gate Lock Pull-to-Open (FM143)

A MUST for added security. Solenoid driven, with a steel housing. Unlocks and locks automatically as gates open and close. Used with **Mighty Mule®** DC swing gate operating systems for maximum stability and security. Comes with a keyed manual release. Recommended for gates over 8 ft. long. Ideal for animal enclosures or high wind areas.



Wireless Entry Intercom / Keypad (FM136)

Allows owner to screen guest at the gate before allowing access to the property. Keypad also allows owner to give up to 25 programmable entry codes to family, friends or approved delivery personnel. Codes can be permanent or temporary. Can be wireless up to 500 feet or hard wired up to 1000 feet. Additional base stations available (F3101MBC).



Low Voltage Wire (RB509)

The 16 gauge, multi-stranded, dual conductor **Low Voltage Wire** is for connecting the AC powered transformer, or the **Solar Panel** to the control board. Also used for the connection of accessories, such as locks, keypads, push buttons and other wired control devices. This specially designed wire is UV treated, PVC coated and ready for direct burial. Available in 1000' rolls or special lengths.

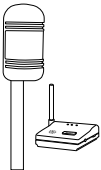

Driveway Alarm (FM131)

Keep track of the comings and goings on your property with this electromagnetic sensor alert system. When a vehicle passes the sensor, the receiver emits an audible tone and lets you know someone's there. Functional range of up to 400 ft. Easy-to-install and stake is included in kit. Transmitter requires 2 "C" batteries (not included)

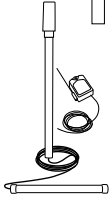

Wireless Driveway Vehicle Sensor (FM130)

The wireless gate opening sensor offers hands free operation of the Mighty Mule Gate Opener. Works wirelessly up to 100 feet from the gate. Transmitter, receiver and two AA batteries are included.

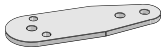

Push to Open Bracket (FM148)

Required when **Mighty Mule®** 350/352 gate operator(s) must push the gate open, such as on a sloping driveway or where space prevents gate(s) from opening inward (pulled open). Order two PTO brackets for conversion of a dual swing gate installation.



Column Mount Lock Receiver (433IH)

For mounting the **Automatic Gate Lock** on brick columns, walls, or for other applications with limited space between gate and post.

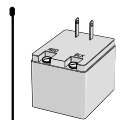

Replacement Transformer (RB570)

Standard 18 volt, 2200 mA, AC transformer for maintaining the battery included with the **Mighty Mule®** 352 gate operator. This is the only transformer approved for use with **all UL325 Mighty Mule®** gate operator systems.



Universal Receiver (RB709U-NB)

The Universal Receiver allows you to use the same **Mighty Mule®** 352 entry transmitter to operate your gate operator and your garage door operator. Compatible with most garage door operators.

**If you have a question about any special order item,
just call 1-800-543-GATE!**

The contents of all material available on this installation manual are copyrighted by GTO, Inc. ("GTO"), unless otherwise indicated. All rights are reserved by GTO, and content may not be reproduced, downloaded, disseminated, published, or transferred in any form or by any means, except with the prior, written permission of GTO. Any reprinting of GTO publications is by permission only. Copyright infringement is a violation of federal law.

Mighty Mule®, E-Z Gate®, GTO®, are registered trademarks of GTO, Inc. America's DIY Automatic Gate Openers is a trademark of GTO, Inc. and are the exclusive property of GTO, Inc. ("GTO").

All rights are reserved by GTO, and these marks may not be used, in any for without the prior, written permission of GTO.