

SUUNTO AMBIT3 RUN

USER GUIDE

1. SAFETY.....	4
2. Getting started.....	5
2.1. Buttons and menus.....	5
2.2. Set up.....	5
2.3. Adjusting settings.....	6
3. Features.....	8
3.1. Activity monitoring.....	8
3.2. Autopause.....	8
3.3. Autoscroll.....	9
3.4. Backlight.....	9
3.5. Button lock.....	10
3.6. Compass.....	10
3.6.1. Setting declination.....	11
3.6.2. Calibrating compass.....	12
3.6.3. Setting bearing lock.....	12
3.7. Countdown timer.....	13
3.8. Displays.....	13
3.8.1. Adjusting display contrast.....	14
3.8.2. Inverting display color.....	14
3.9. Exercising with sport modes.....	14
3.9.1. Using Suunto Smart Sensor.....	14
3.9.2. Putting on Suunto Smart Sensor.....	15
3.9.3. Starting an exercise.....	16
3.9.4. During exercise.....	16
3.9.5. Recording tracks.....	17
3.9.6. Making laps.....	17
3.9.7. Navigating during exercise.....	17
3.9.8. Using compass during exercise.....	18
3.10. Find back.....	18
3.11. Firmware updates.....	18
3.12. FusedSpeed.....	19
3.13. Icons.....	20
3.14. Interval timer.....	21
3.15. Logbook.....	22
3.16. Memory left indicator.....	23
3.17. Navigating with GPS.....	24
3.17.1. Getting GPS signal.....	24
3.17.2. GPS grids and position formats.....	25
3.17.3. GPS accuracy and power saving.....	25
3.18. Notifications.....	25

3.19. PODs and HR sensors.....	26
3.19.1. Pairing PODs and HR sensors.....	26
3.19.2. Using foot POD.....	27
3.20. Points of interest.....	28
3.20.1. Checking your location.....	29
3.20.2. Adding your location as a POI.....	30
3.20.3. Deleting a POI.....	30
3.21. Recovery.....	31
3.21.1. Recovery time.....	31
3.21.2. Recovery status.....	31
3.22. Routes.....	33
3.22.1. Navigating a route.....	34
3.22.2. During navigation.....	36
3.23. Running performance level.....	37
3.24. Service menu.....	39
3.25. Shortcuts.....	39
3.26. Sport modes.....	40
3.27. Stopwatch.....	40
3.28. Suunto app.....	41
3.28.1. Syncing with mobile app.....	42
3.29. Suunto Apps.....	42
3.30. Time.....	42
3.30.1. Alarm clock.....	43
3.30.2. Time syncing.....	44
3.31. Track back.....	44
4. Care and support.....	45
4.1. Handling guidelines.....	45
4.2. Water resistance.....	45
4.3. Charging the battery.....	45
4.4. Replacing Smart Sensor battery.....	46
5. Reference.....	47
5.1. Technical specifications.....	47
5.2. Compliance.....	48
5.2.1. CE.....	48
5.2.2. FCC compliance.....	48
5.2.3. ISED REGULATORY COMPLIANCE.....	48
5.2.4. NOM-121-SCT1-2009.....	49
5.3. Trademark.....	49
5.4. Patent notice.....	49
5.5. International Limited Warranty.....	49
5.6. Copyright.....	50

1. SAFETY

Types of safety precautions

 **WARNING:** - is used in connection with a procedure or situation that may result in serious injury or death.

 **CAUTION:** - is used in connection with a procedure or situation that will result in damage to the product.

 **NOTE:** - is used to emphasize important information.

 **TIP:** - is used for extra tips on how to utilize the features and functions of the device.

Safety precautions

 **WARNING:** ALLERGIC REACTIONS OR SKIN IRRITATIONS MAY OCCUR WHEN PRODUCT IS IN CONTACT WITH SKIN, EVEN THOUGH OUR PRODUCTS COMPLY WITH INDUSTRY STANDARDS. IN SUCH EVENT, STOP USE IMMEDIATELY AND CONSULT A DOCTOR.

 **WARNING:** ALWAYS CONSULT YOUR DOCTOR BEFORE BEGINNING AN EXERCISE PROGRAM. OVEREXERTION MAY CAUSE SERIOUS INJURY.

 **WARNING:** ONLY FOR RECREATIONAL USE.

 **WARNING:** DO NOT ENTIRELY RELY ON THE GPS OR BATTERY LIFETIME, ALWAYS USE MAPS AND OTHER BACKUP MATERIAL TO ENSURE YOUR SAFETY.

 **CAUTION:** DO NOT APPLY SOLVENT OF ANY KIND TO THE PRODUCT, AS IT MAY DAMAGE THE SURFACE.

 **CAUTION:** DO NOT APPLY INSECT REPELLENT ON THE PRODUCT, AS IT MAY DAMAGE THE SURFACE.

 **CAUTION:** DO NOT THROW THE PRODUCT AWAY, BUT TREAT IT AS ELECTRONIC WASTE TO PRESERVE THE ENVIRONMENT.

 **CAUTION:** DO NOT KNOCK OR DROP THE DEVICE, AS IT MAY BE DAMAGED.

2. Getting started

2.1. Buttons and menus

Suunto Ambit3 Run has five buttons which allow you to access all the features.

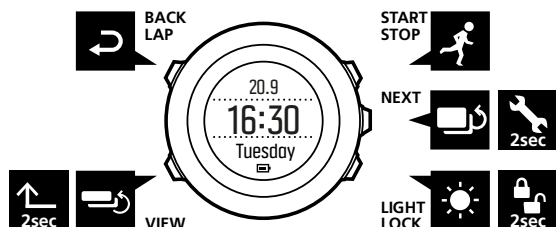

[Start Stop] :

- press to access the start menu
- press to start, pause or resume an exercise or timer
- press to increase a value or move up in the menu
- keep pressed to stop and save an exercise

[Next] :

- press to change displays
- press to accept a setting
- keep pressed to access/exit the options menu
- keep pressed to access/exit the options menu in sport modes

[Light Lock] :

- press to activate the backlight
- press to decrease a value or move down in the menu
- keep pressed to lock/unlock the buttons

[View] :

- press to change bottom row view
- keep pressed to toggle the display between light and dark
- keep pressed to access shortcut (see 3.25. *Shortcuts*)

[Back Lap] :

- press return to the previous menu
- press to add a lap during exercise

 **TIP:** When changing values, you can increase the speed by keeping [Start Stop] or [Light Lock] pressed until the values start to scroll faster.

2.2. Set up

Your Suunto Ambit3 Run wakes up automatically when you attach it to your computer or a USB charger using the supplied USB cable.

To start using your sports watch:

1. Connect your sports watch to a power source with the supplied USB cable.

2. Disconnect the USB cable if you are using a computer (to unlock buttons).
3. Press [Start Stop] or [Light Lock] to scroll to the desired language and press [Next] to select.
4. Pair with Suunto app (see 3.28. *Suunto app*) by pressing [Start Stop] or skip by pressing [Next] .
5. Follow the startup wizard to complete initial settings. Set values with [Start Stop] or [Light Lock] and press [Next] to accept and go to the next step.
6. Reconnect USB cable and charge until battery indicator is 100%.

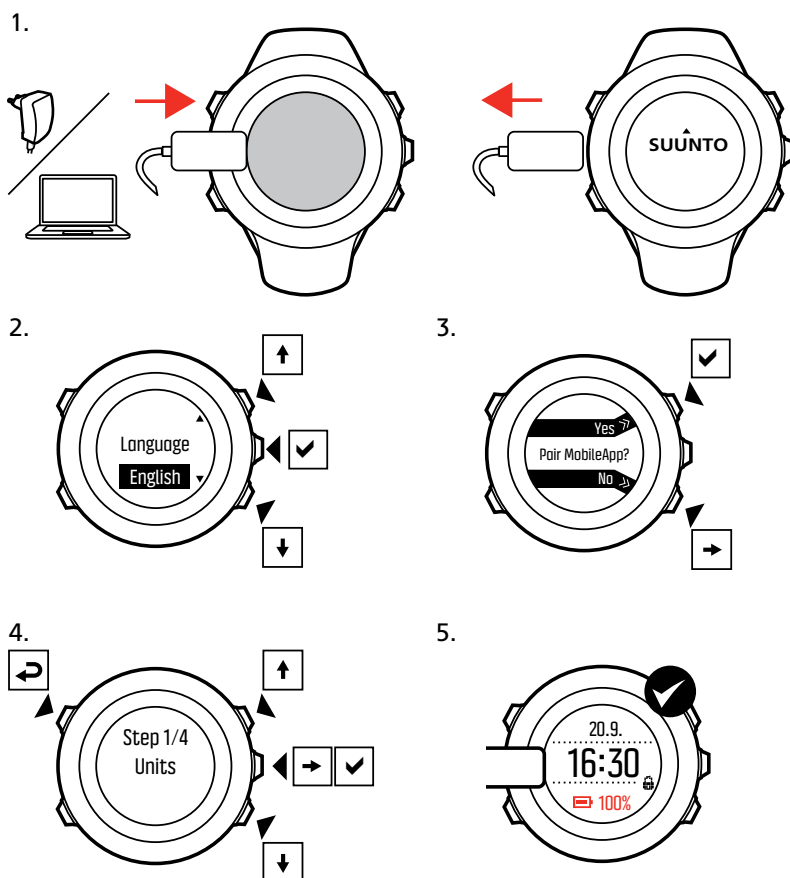

Fully charging an empty battery takes about 2-3 hours. Buttons are locked while the USB cable is attached and connected to a computer.

You can exit the startup wizard at any time by keeping [Next] pressed.

The startup wizard takes you through the following settings:

- Units
- Time
- Date
- Personal settings (gender, age, weight)

2.3. Adjusting settings

You can change the settings of your Suunto Ambit3 Run directly in the watch or via SuuntoLink.

To change the settings in the watch:

1. Keep [Next] pressed to enter the options menu.
2. Scroll the menu with [Start Stop] and [Light Lock].
3. Press [Next] to enter a setting.
4. Press [Start Stop] and [Light Lock] to adjust the setting values.
5. Press [Back Lap] to return to the previous menu or keep [Next] pressed to exit.

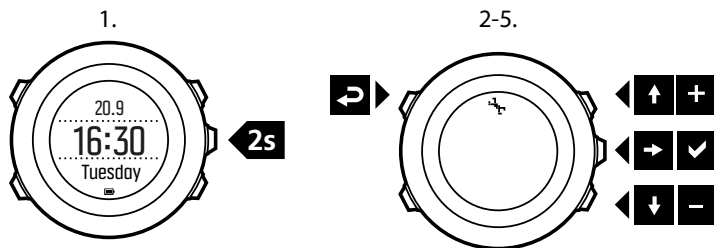

3. Features

3.1. Activity monitoring

In addition to the recovery time shown in your exercise log, Suunto Ambit3 Run monitors your overall activity, both exercise and daily activity. Activity monitoring gives you a complete picture of your activity, the calories you are burning, and your recovery time.

Activity monitoring is available as a default display in **TIME**. You can view the display by pressing [Next] (last display).

You can show/hide the activity monitoring display from the start menu under **DISPLAYS » Activity**. Toggle with [Next].

The activity monitoring display has three views which you can change by pressing [View].

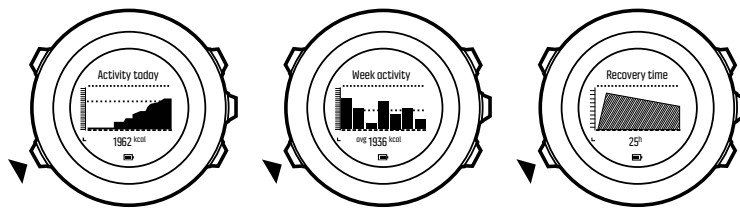

- **Activity today:** calorie consumption today; the dotted line on the bar graph indicates average daily calorie consumption for the past seven days, not including today
- **Week activity:** daily calorie consumption over the last seven days with today furthest to the right; the dotted line on the bar graph and lower row indicate average daily calorie consumption for the past seven days, not including today
- **Recovery time:** recovery time for the next 24 hours based on recorded exercises and daily activity

3.2. Autopause

Autopause pauses the recording of your exercise when your speed is less than 2 km/h (1.2 mph). When your speed increases to more than 3 km/h (1.9 mph), the recording continues automatically.

You can turn **Autopause** on/off for each sport mode in SuuntoLink under the advanced settings for the sport mode.

You can also turn **Autopause** on/off during exercise without any effect on your SuuntoLink settings.

To turn **Autopause** on/off during exercise:

1. While you are in a sport mode, keep [Next] pressed to access the options menu.
2. Scroll to **ACTIVATE** with [Light Lock] and select with [Next].
3. Scroll to **Autopause** with [Start Stop] and select with [Next].
4. Toggle on/off with [Start Stop] or [Light Lock].
5. Keep [Next] pressed to exit.

3.3. Autoscroll

Set your watch to automatically scroll through your sport mode displays while exercising by using **Autoscroll**.

In SuuntoLink, you can turn **Autoscroll** on/off for each sport mode and define how long the displays are shown.

You can also turn **Autoscroll** on/off during exercise without any effect on your SuuntoLink settings.

To turn **Autoscroll** on/off during exercise:

1. While you are in a sport mode, keep [Next] pressed to access the options menu.
2. Scroll to **ACTIVATE** with [Light Lock] and select with [Next].
3. Scroll to **Autoscroll** with [Start Stop] and select with [Next].
4. Toggle on/off with [Start Stop] or [Light Lock].
5. Keep [Next] pressed to exit.

3.4. Backlight

Pressing [Light Lock] activates the backlight.

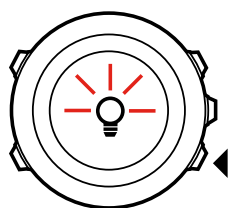

By default, the backlight turns on for a few seconds and turns off automatically. This is the **Normal** mode.

There are four backlight modes:

Mode:

- **Normal:** The backlight turns on for a few seconds when you press [Light Lock] and when the alarm clock sounds.
- **Off:** The backlight is not switched on by pressing a button or when the alarm clock sounds.
- **Night:** The backlight turns on for a few seconds when you press any button and when the alarm clock sounds.
- **Toggle:** The backlight turns on when you press [Light Lock] and stays on until you press [Light Lock] again.

Your Suunto Ambit3 Run has two backlight settings: one 'general' setting and one for sport modes.

You can change the general backlight setting in the watch settings under **GENERAL » Tones/display » Backlight**. See 2.3. *Adjusting settings*. You can also change the general setting in SuuntoLink.

Your sport modes can use the same backlight mode as the general setting (default), or you can define a different mode for each sport mode under the advanced settings in SuuntoLink.

In addition to the mode, you can adjust the backlight brightness (in percent), either in the watch settings under **GENERAL » Tones/display » Backlight** or in SuuntoLink.

 **TIP:** When the [Back Lap] and [Start Stop] buttons are locked, you can still activate the backlight by pressing [Light Lock].

3.5. Button lock

Keeping [Light Lock] pressed locks and unlocks buttons.

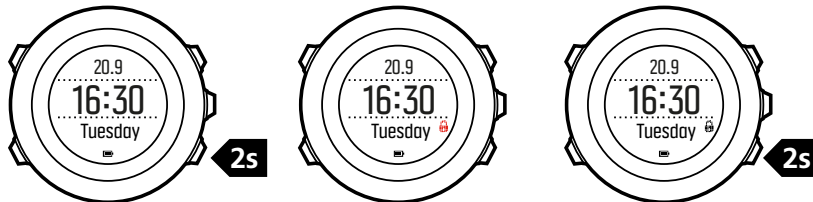

You can change the button lock behavior in the watch settings under **GENERAL » Tones/display » Button lock**.

Your Suunto Ambit3 Run has two button lock settings: one for general use, **Time mode lock**, and one for when you are exercising, **Sport mode lock**:

Time mode lock:

- **Actions only:** Start and options menus are locked.
- **All buttons:** All buttons are locked. Backlight can be activated in **Night** mode.

Sport mode lock

- **Actions only:** [Start Stop], [Back Lap] and the options menu are locked during exercise.
- **All buttons:** All buttons are locked. Backlight can be activated in **Night** mode.

 **TIP:** Select the **Actions only** button lock setting for sport modes to avoid accidentally starting or stopping your log. When the [Back Lap] and [Start Stop] buttons are locked, you can still change displays by pressing [Next] and views by pressing [View].

3.6. Compass

Suunto Ambit3 Run has a digital compass that allows you to orient yourself in relation to magnetic north. The tilt-compensated compass gives you accurate readings even if the compass is not horizontally level.

You can show/hide the compass display from the options menu while in a sport mode under **ACTIVATE » Compass**.

The compass display includes the following information:

- middle row: compass heading in degrees
- bottom row: change view to current heading in cardinals, to time or empty with [View]

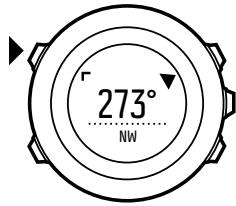

The compass switches to power saving mode after one minute. Reactivate it with [Start Stop].

3.6.1. Setting declination

To ensure correct compass readings, set an accurate declination value.

Paper maps point to true north. Compasses, however, point to magnetic north – a region above the Earth where the Earth’s magnetic fields pull. Because magnetic North and true North are not at the same location, you must set the declination on your compass. The angle in between magnetic and true north is your declination.

The declination value appears on most maps. The location of magnetic north changes yearly, so the most accurate and up-to-date declination value can be obtained from the internet (for example www.magnetic-declination.com).

Orienteering maps, however, are drawn in relation to magnetic north. This means that when you are using orienteering maps you need to turn the declination correction off by setting the declination value to 0 degrees.

To set the declination value:

1. Keep [Next] pressed to enter the options menu.
2. Press [Next] to enter **GENERAL**.
3. Scroll to **Compass** using [Light Lock] and select with [Next].
4. Scroll to **Declination** with [Light Lock] and select with [Next].
5. Turn the declination off by selecting –, or select **W** (west) or **E** (east).
6. Set the declination value with [Start Stop] or [Light Lock].
7. Press [Next] to accept the setting.

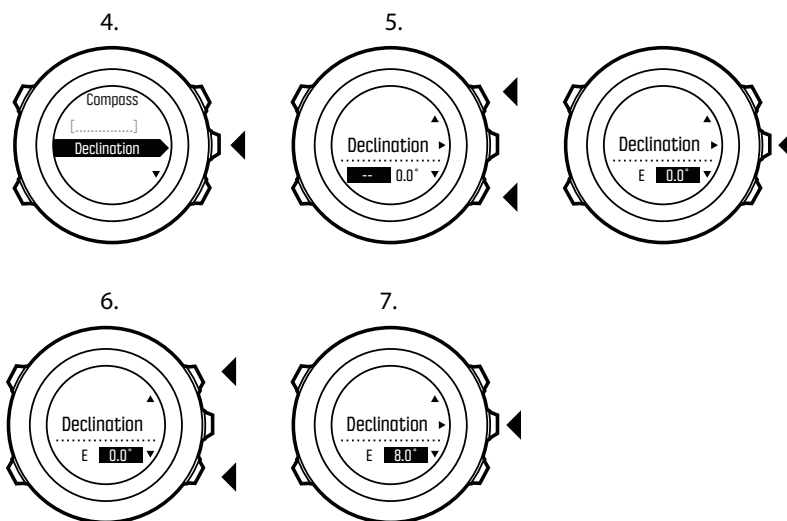

 **TIP:** You can also access the compass settings by keeping [View] pressed in **COMPASS** mode.

3.6.2. Calibrating compass

If you have not used the compass before, you must first calibrate it. Turn and tilt the watch in multiple directions until the watch beeps, indicating calibration is complete.

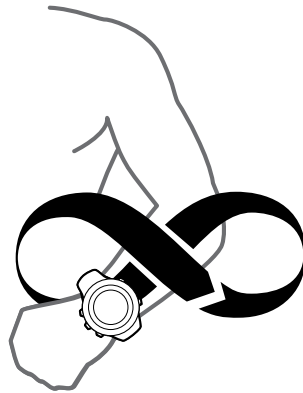
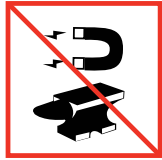

If you have already calibrated the compass and want to re-calibrate it, you can access the calibration option in the options menu.

If the calibration is successful, the text **CALIBRATION SUCCESSFUL** is displayed. If the calibration does not succeed, the text **CALIBRATION FAILED** is displayed. To retry the calibration, press [Start Stop] .

To manually start compass calibration:

1. Keep [Next] pressed to enter the options menu.
2. Select to **GENERAL** with [Next] .
3. Scroll to **Compass** with [Light Lock] and select with [Next] .
4. Press [Next] to select **Calibration**.

3.6.3. Setting bearing lock

You can mark the direction to your target in relation to North with the bearing lock feature.

To lock a bearing:

1. With the compass active, hold the watch in front of you and turn yourself towards your target.
2. Press [Back Lap] to lock the current degree displayed on the watch as your bearing.
3. An empty triangle indicates the locked bearing in relation to the North indicator (solid triangle).
4. Press [Back Lap] to clear the bearing lock.

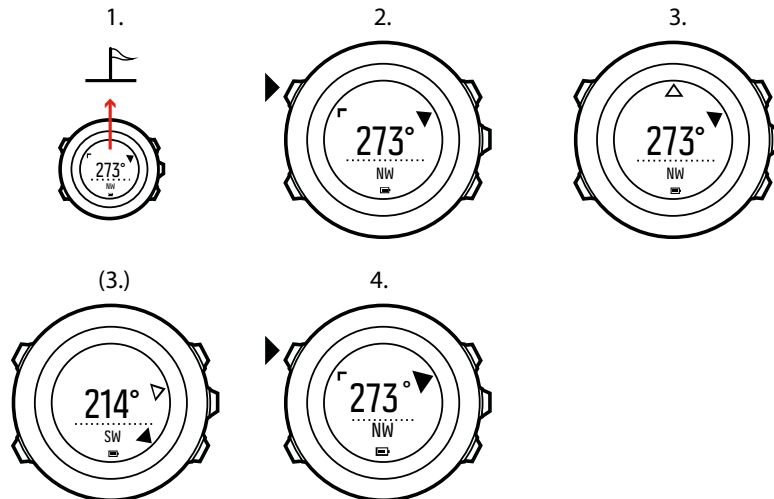

 **NOTE:** While using the compass in an exercise mode, the [Back Lap] button only locks and clears the bearing. Exit the compass view to make a lap with [Back Lap].

3.7. Countdown timer

You can use the countdown timer to count down from a preset time to zero. The timer makes a short sound every second during the last 10 seconds and sounds an alarm when zero is reached.

You can show/hide the countdown timer from the start menu under **DISPLAYS » Countdown**. Toggle with [Next].

To set the countdown time:

1. Press [Next] to until you reach the countdown timer display.
2. Press [View] to adjust the countdown time.
3. Set the hours and minutes with [Start Stop] and [Light Lock] . Accept with [Next] .
4. Press [Start Stop] to start the countdown.

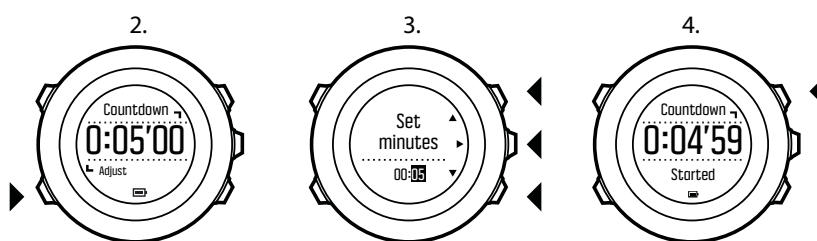

 **TIP:** You can pause/continue the countdown by pressing [Start Stop].

3.8. Displays

Your Suunto Ambit3 Run comes with several different features, such as the stopwatch (see 3.27. Stopwatch), that are handled as displays that can be viewed by pressing [Next]. Some of them are permanent, and others you can show or hide as you like.

To show/hide displays:

1. Press [Start Stop] to enter the start menu.

2. Scroll to **DISPLAYS** by pressing [Light Lock] and press [Next] .
3. In the list of display, toggle any feature on/off by scrolling to it with Start Stop or Light Lock and pressing Next. Keep [Next] pressed to exit the displays menu if needed.

Your sport modes (see 3.26. *Sport modes*) also have multiple displays that that you can customize to view different information while you exercise.

3.8.1. Adjusting display contrast

Increase or decrease the display contrast of your Suunto Ambit3 Run in the watch settings.

To adjust the display contrast:

1. Keep [Next] pressed to enter the options menu.
2. Press [Next] to enter the **GENERAL** settings.
3. Press [Next] to enter **Tones/display**.
4. Scroll to **Display contrast** with [Light Lock] and enter with [Next] .
5. Increase the contrast with [Start Stop] , or decrease it with [Light Lock] .
6. Keep [Next] pressed to exit.

3.8.2. Inverting display color

Change the display between dark and light through the settings in the watch or in SuuntoLink, or by simply using the default [View] button shortcut (see 2.1. *Buttons and menus*). You can also define the display color for a sport mode in SuuntoLink.

To invert the display in the watch settings:

1. Keep [Next] pressed to enter the options menu.
2. Press [Next] to enter the **GENERAL** settings.
3. Press [Next] to enter **Tones/display**.
4. Scroll to **Invert display** with [Start Stop] and invert with [Next] .

3.9. Exercising with sport modes

Use sport modes (see 3.26. *Sport modes*) to record exercise logs and view various information during your exercise.

You can access the sport modes under **EXERCISE** menu by pressing [Start Stop] .

3.9.1. Using Suunto Smart Sensor

A Bluetooth® Smart compatible heart rate sensor, such as the Suunto Smart Sensor, can be used with your Suunto Ambit3 Run to give you more detailed information about your exercise intensity.

While exercising, the heart rate sensor enables:

- heart rate in real time
- average heart rate in real time
- heart rate in graph form
- calories burned during exercise
- guidance to exercise within defined heart rate limits
- Peak Training Effect

And after exercise, the heart rate sensor provides:

- total calories burned during exercise
- average heart rate
- peak heart rate
- recovery time

If you use the Suunto Smart Sensor, you also have the added advantage of heart rate memory. The Suunto Smart Sensor memory function buffers data whenever the transmission to your Suunto Ambit3 Run is interrupted.

This allows you to get accurate exercise intensity information in activities such as swimming where water blocks the transmission. It also means you can even leave your Suunto Ambit3 Run behind after starting a recording. For more information, please refer to the Suunto Smart Sensor User Guide.

Without a heart rate sensor, your Suunto Ambit3 Run provides calorie consumption and recovery time for running activities where speed is used to estimate intensity. However, we recommend using a heart rate sensor to get accurate intensity readings.

Refer to the user guide for Suunto Smart Sensor or other Bluetooth Smart compatible heart rate sensor for additional information.

3.9.2. Putting on Suunto Smart Sensor

To start using the Suunto Smart Sensor:

1. Snap the sensor firmly into the strap connector.
2. Adjust the strap length as needed.
3. Moisten the strap electrode areas with water or electrode gel.
4. Put the strap on so that it fits snugly and the Suunto logo is facing up.

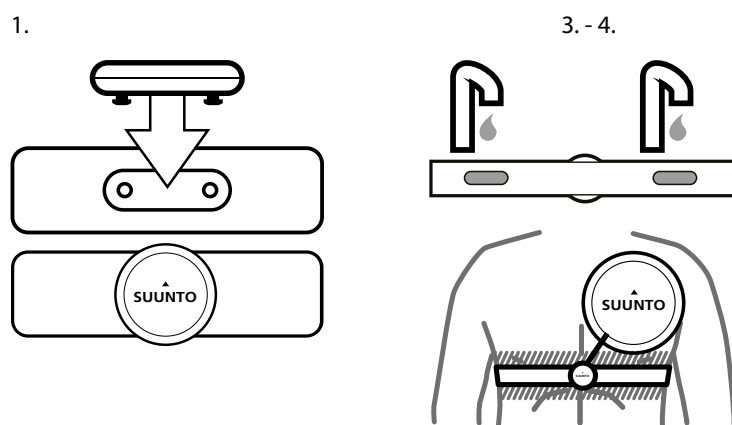

The Smart Sensor turns on automatically when it detects a heart beat.

 **TIP:** Wear the strap against your bare skin for best results.

Refer to the Suunto Smart Sensor User Guide for additional information and troubleshooting.

 **NOTE:** Dry skin under the belt electrodes, a loose belt, and synthetic shirt materials can cause abnormally high heart rate readings. Moisten the belt electrodes well and tighten the belt to avoid heart rate peaks. If you are otherwise concerned about your heart rate, please consult a doctor.

3.9.3. Starting an exercise

To start exercising:

1. Press [Start Stop] to enter the start menu.
2. Press [Next] to enter **EXERCISE**.
3. Scroll the sport mode options with [Start Stop] or [Light Lock] and select a suitable mode with [Next] .
4. The watch automatically starts searching for a heart rate belt signal, if the selected sport mode uses a heart rate belt. Wait for the watch to notify that the heart rate and/or GPS signal have been found, or press [Start Stop] to select **Later**. The watch continues to search the heart rate/GPS signal.
5. Press [Start Stop] to start recording your exercise. To access additional options while exercising, keep [Next] pressed.

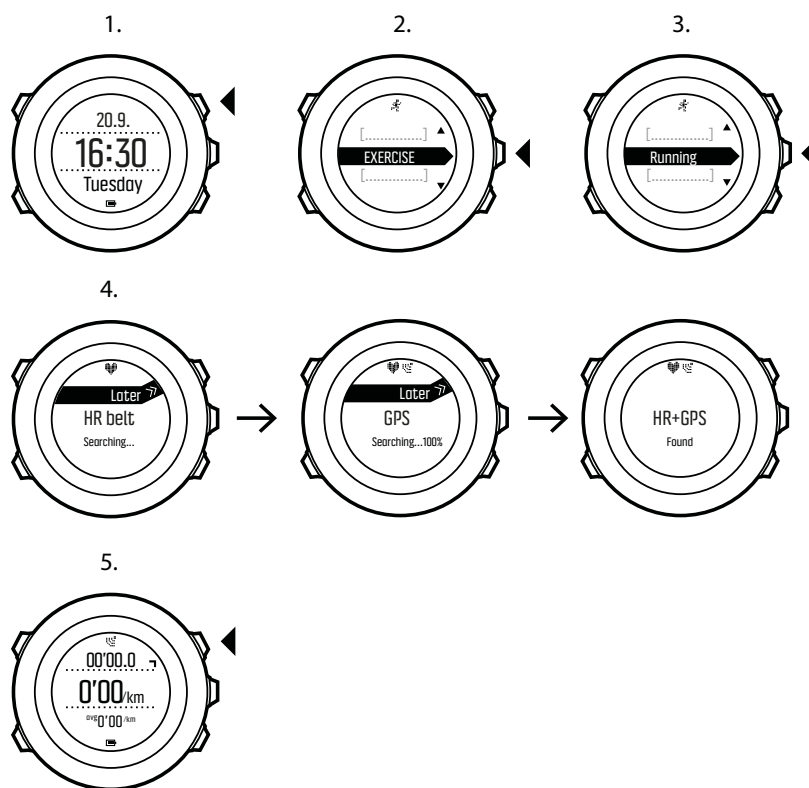

3.9.4. During exercise

Suunto Ambit3 Run gives you a wealth of information during your exercise. The information varies depending on the sport mode you have selected (see 3.26. *Sport modes*). You get even more information, if you use a heart rate belt and GPS during exercise.

Here are some ideas on how to use the watch during exercise:

- Press [Next] to see scroll through your sport mode displays.
- Press [View] to see different information the bottom row of the display.
- To avoid accidentally stopping your log recording or making unwanted laps, lock the buttons by keeping [Light Lock] pressed.
- Press [Start Stop] to pause recording. To resume recording, press [Start Stop] again.

3.9.5. Recording tracks

Depending on the sport mode you have selected, your Suunto Ambit3 Run allows you to record various information during exercise.

If your sport mode has GPS enabled, Suunto Ambit3 Run also records your track during your exercise. You can view the track in Suunto app as part of the recorded exercise.

3.9.6. Making laps

During your exercise, you can make laps either manually or automatically by setting the autolap interval in SuuntoLink. When you are making laps automatically, Suunto Ambit3 Run records the laps based on the distance you have specified in SuuntoLink.

To make laps manually, press [Back Lap] during the exercise.

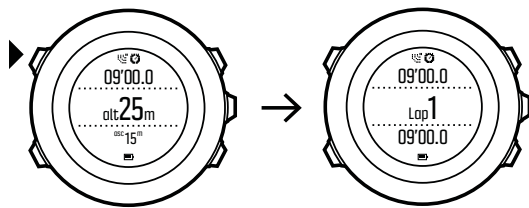

Suunto Ambit3 Run shows you the following information:

- top row: split time (duration from the start of the log)
- middle row: lap number
- bottom row: lap time

 **NOTE:** The exercise summary always shows at least one lap, your exercise from start to finish. The laps you have made during the exercise are shown as additional laps.

3.9.7. Navigating during exercise

If you want to run a route or to a point of interest (POI), you can select a sport mode, such as Run a Route, and begin navigating immediately.

You can also navigate a route or to a POI during your exercise in other sport modes that have GPS activated.

To navigate during exercise:

1. While you are in a sport mode with GPS activated, keep [Next] pressed to access the options menu.
2. Press [Next] to select **NAVIGATION**.
3. Scroll to **POIs (Points of interest)** or **Routes** with [Light Lock] and select with [Next]. The navigation guidance is shown as the last display on the selected sport mode.

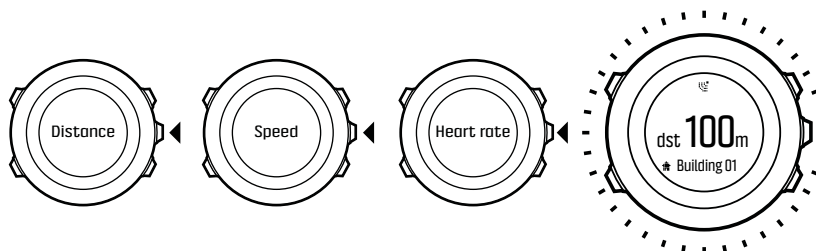

To deactivate navigation, go back to **NAVIGATION** in the options menu and select **End navigation**.

 **NOTE:** If the GPS accuracy setting (see 3.17.3. GPS accuracy and power saving) of your sport mode is **Good** or lower, while navigating GPS accuracy switches to **Best**. Battery consumption is therefore higher.

3.9.8. Using compass during exercise

You can activate the compass and add it to a custom sport mode during your exercise.

To use the compass during exercise:

1. While you are in a sport mode, keep [Next] pressed to access the options menu.
2. Scroll to **ACTIVATE** with [Light Lock] and select with [Next] .
3. Scroll to **Compass** with [Light Lock] and select with [Next] .
4. The compass is shown as the last display on the custom sport mode.

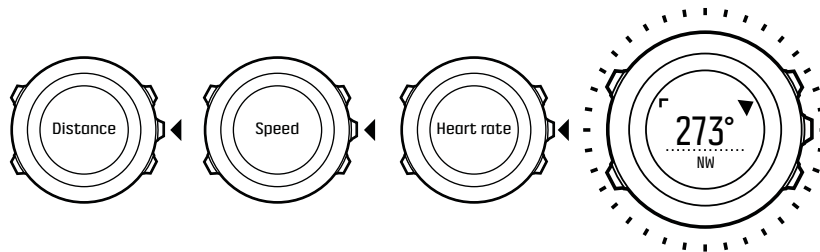

To deactivate the compass, go back to **ACTIVATE** in the options menu and select **End compass**.

3.10. Find back

Suunto Ambit3 Run automatically saves the starting point of your exercise, if you are using GPS. With Find back, Suunto Ambit3 Run can guide you directly back to your starting point (or to the location where the GPS fix was established).

To find back:

1. While you are in a sport mode, keep [Next] pressed to access the options menu.
2. Press [Next] to select **NAVIGATION**.
3. Scroll to **Find back** with [Start Stop] and select with [Next] . The navigation guidance is shown as the last display on the selected sport mode.

3.11. Firmware updates

You can update your Suunto Ambit3 Run software through SuuntoLink. Make sure to sync your watch with Suunto app before you update the software, all logs will be deleted from the watch during the update.

To update your Suunto Ambit3 Run software:

1. Upload your exercises to Suunto app.
2. Install SuuntoLink if you have not done so already (www.suunto.com/suuntolink).
3. Connect your Suunto Ambit3 Run to your computer with the supplied USB cable and follow the instructions.

3.12. FusedSpeed

FusedSpeed™ is a unique combination of GPS and wrist acceleration sensor readings for measuring your running speed more accurately. The GPS signal is adaptively filtered based on wrist acceleration, giving more accurate readings at steady running speeds and a quicker responses to changes in speed.

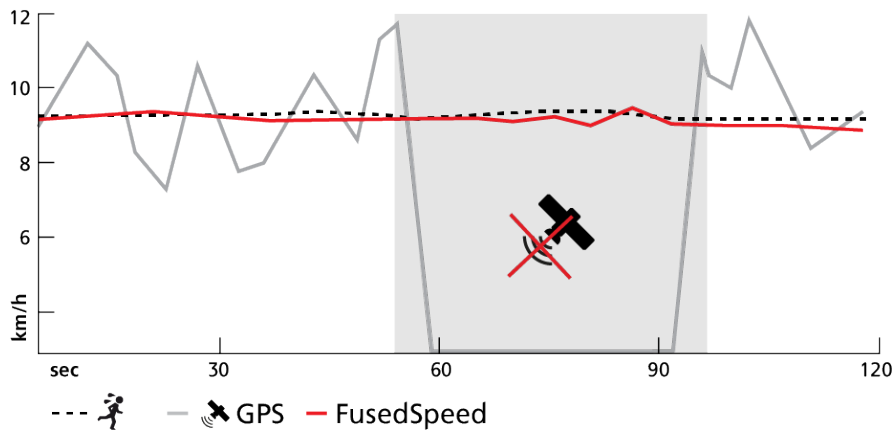

FusedSpeed benefits you the most when you need highly reactive speed readings during training, for example, when running on uneven terrain or during interval training. If you temporarily lose the GPS signal, for example, Suunto Ambit3 Run is able to continue showing accurate speed readings with the help of the GPS calibrated accelerometer.

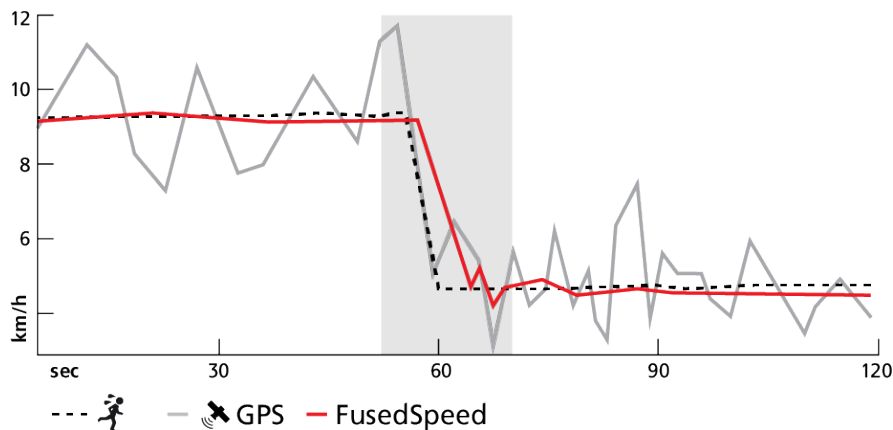

TIP: To get the most accurate readings with FusedSpeed, only glance shortly at the watch when needed. Holding the watch in front of you without moving it reduces the accuracy.







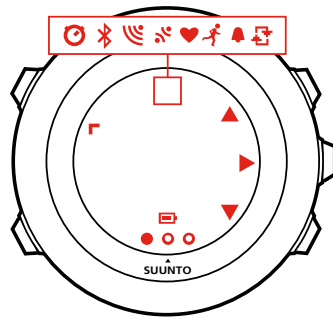











FusedSpeed is automatically enabled for running and other similar types of activities, such as orienteering, floor ball and football (soccer).

To enable FusedSpeed for a custom sport mode, ensure you select an activity that uses FusedSpeed. This is indicated at the end of the sport mode advanced settings section in SuuntoLink.

3.13. Icons





















The following icons are displayed in Suunto Ambit3 Run:

	alarm
	battery
	Bluetooth activity
	button lock
	button press indicators
	chronograph
	current display
	down/decrease
	GPS signal strength
	heart rate
	incoming call
	interval timer
	message/notification
	missed call
	next/confirm
	pairing
	settings
	sport mode
	up/increase

POI icons

The following POI icons are available in Suunto Ambit3 Run:

	begin
	building/home
	camp/camping
	car/parking
	cave
	crossroad
	end
	food/restaurant/cafe
	forest
	geocache
	lodging/hostel/hotel
	meadow
	mountain/hill/valley/cliff
	road/trail
	rock
	sight
	water/river/lake/coast
	waypoint

3.14. Interval timer

You can add an interval timer to each custom sport mode in SuuntoLink. To add the interval timer to a sport mode, select the sport mode and go to **Advanced settings**. The next time you connect your Suunto Ambit3 Run to SuuntoLink, the interval timer is synchronized to the watch.

You can specify the following information in the interval timer:

- interval types (**HIGH** and **LOW** interval)
- duration or distance for both interval types
- number of times the intervals are repeated

 **NOTE:** If you do not set the number of repetitions for the intervals in SuuntoLink, the interval timer continues until it has been repeated 99 times.

To activate/deactivate the interval timer:

1. While you are in a sport mode, keep [Next] pressed to access the options menu.
 2. Scroll to **ACTIVATE** with [Light Lock] and select with [Next] .
 3. Scroll to **Interval** with [Start Stop] and select with [Next] .
 4. Press [Start Stop] or [Light Lock] to set the interval timer **On/Off** and accept with [Next] .
- When the interval timer is active, the interval icon is shown at the top of the display.

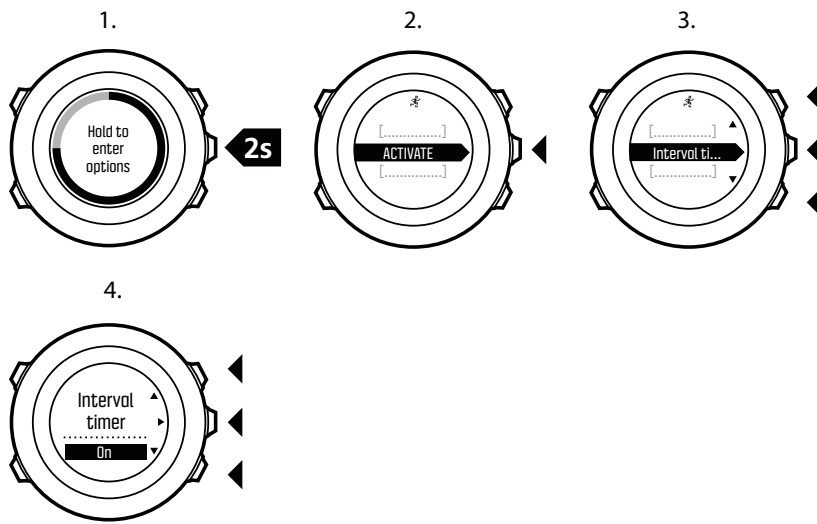

3.15. Logbook

The logbook stores the logs of your recorded activities. The maximum number of logs and the maximum duration of a single log depend on how much information is recorded in each activity. GPS accuracy (see 3.17.3. *GPS accuracy and power saving*) and using the interval timer (see 3.14. *Interval timer*), for example, directly impact the number and duration of logs that can be stored.

You can view the log summary of your activity right after you have stopped recording or through the **LOGBOOK** under the start menu.

The information shown in the log summary is dynamic: it changes depending factors such as sport mode and whether or not you used an heart rate belt or GPS. By default, all logs include at minimum the following information:

- sport mode name
- time
- date
- duration
- laps

If the log has GPS data, the logbook entry includes a view of the full route track.

 **TIP:** You can see many more details of your recorded activities in Suunto app.

To view log summary after stopping a recording:

1. Keep [Start Stop] pressed to stop and save the exercise. Alternatively, you press [Start Stop] to pause the recording. After pausing, stop by pressing [Back Lap] , or continue recording by pressing [Start Stop] . After pausing and stopping the exercise, save the log by pressing [Start Stop] . If you do not want to save the log, press [Light Lock] . If you do not save the log, you can still view the log summary after pressing [Light Lock] , but the log is not stored in the logbook for later viewing.
2. Press [Next] to view the log summary.

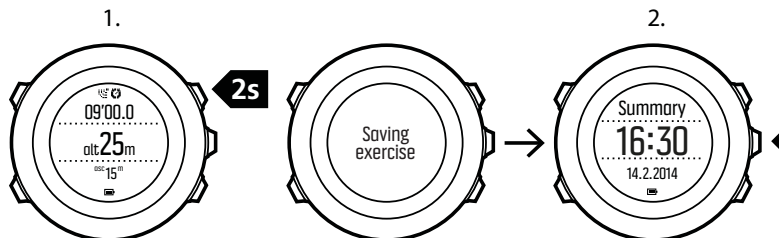

You can also view the summaries of all your saved exercises in the logbook. In the logbook the exercises are listed according to date and time.

To view summary log in the logbook:

1. Press [Start Stop] to enter the start menu.
2. Scroll to **LOGBOOK** with [Light Lock] and enter with [Next] . Your current recovery time is shown.
3. Scroll the logs with [Start Stop] or [Light Lock] and select a log with [Next] .
4. Browse the summary views of the log with [Next] .

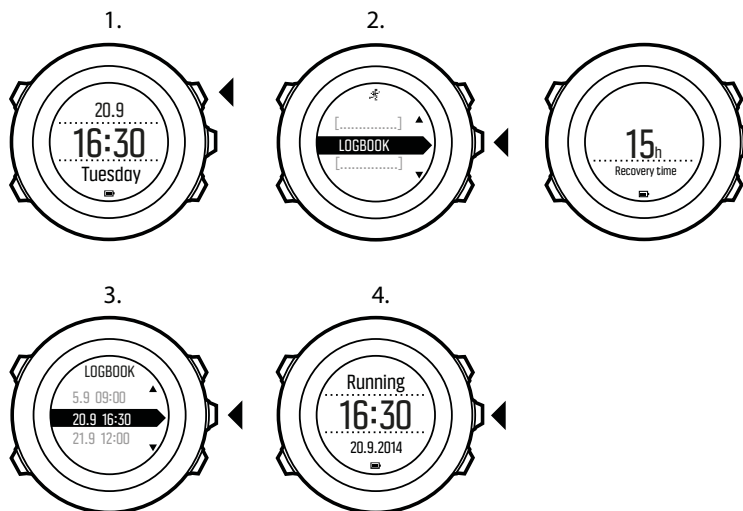

If the log includes multiple laps, you can view lap-specific information by pressing [View] .

3.16. Memory left indicator

If more than 50 % of the logbook has not been synchronized with Suunto app, Suunto Ambit3 Run displays a reminder when you enter the logbook.

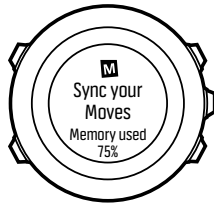

The reminder is not displayed once the unsynced memory is full and Suunto Ambit3 Run begins overwriting old logs.

3.17. Navigating with GPS

Suunto Ambit3 Run uses the Global Positioning System (GPS) to determine your current position. GPS incorporates a set of satellites that orbit the Earth at an altitude of 20,000 km at the speed of 4 km/s.

The built-in GPS receiver in Suunto Ambit3 Run is optimized for wrist use and receives data from a very wide angle.

3.17.1. Getting GPS signal

Suunto Ambit3 Run activates GPS automatically when you select a sport mode with the GPS functionality, determine your location, or start navigating.

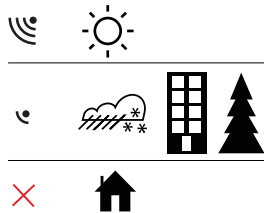

 **NOTE:** When you activate GPS for the first time, or have not used it for a long time, it might take longer than usual to get a GPS fix. Subsequent GPS starts will take less time.

 **TIP:** To minimize GPS initiation time, hold the watch steady with GPS facing up and make sure you are in an open area so that the watch has a clear view of the sky.

 **TIP:** Regularly synchronize your Suunto Ambit3 Run with Suunto app to get the latest satellite orbit data (GPS optimization). This reduces the time needed to get the GPS fix and improves track accuracy.

Troubleshooting: No GPS signal

- For an optimal signal, point the GPS part of the watch upwards. The best signal can be received in an open area with a clear view of the sky.
- The GPS receiver usually works well inside tents and other thin covers. However, objects, buildings, dense vegetation or cloudy weather can reduce the GPS signal reception quality.
- GPS signal does not penetrate any solid constructions or water. Therefore do not try to activate GPS for example inside buildings, caves, or under water.

3.17.2. GPS grids and position formats

Grids are lines on a map that define the coordinate system used on the map.

Position format is the way the GPS receiver's position is displayed on the watch. All the formats relate to the same location, they only express it in a different way. You can change the position format in the watch settings under **GENERAL » Format » Position format**.

You can select the format from the following grids:

- latitude/longitude is the most commonly used grid and has three different formats:
 - **WGS84 Hd.d°**
 - **WGS84 Hd°m.m'**
 - **WGS84 Hd°m's.s**
- **UTM** (Universal Transverse Mercator) gives a two-dimensional horizontal position presentation.
- **MGRS** (Military Grid Reference System) is an extension of UTM and consists of a grid zone designator, 100,000-meter square identifier and a numerical location.

Suunto Ambit3 Run also supports the following local grids:

- **British (BNG)**
- **Finnish (ETRS-TM35FIN)**
- **Finnish (KKJ)**
- **Irish (IG)**
- **Swedish (RT90)**
- **Swiss (CH1903)**
- **UTM NAD27 Alaska**
- **UTM NAD27 Conus**
- **UTM NAD83**
- **NZTM2000** (New Zealand)



NOTE: Some grids cannot be used in the areas north of 84°N and south of 80°S, or outside the countries that they are intended for.

3.17.3. GPS accuracy and power saving

When customizing sport modes, you can define the GPS fix interval using the GPS accuracy setting in SuuntoLink. The shorter the interval, the better the accuracy during exercise.

By increasing the interval and lowering the accuracy, you can extend the battery life.

The GPS accuracy options are:

- Best: ~ 1 sec fix interval, highest power consumption
- Good: ~ 5 sec fix interval, moderate power consumption
- OK: ~ 60 sec fix interval, lowest power consumption
- Off: no GPS fix

3.18. Notifications

If you have paired your watch with Suunto app, you can receive notifications such as incoming calls and text messages on your watch. When a notification arrives, a pop-up appears on the watch.

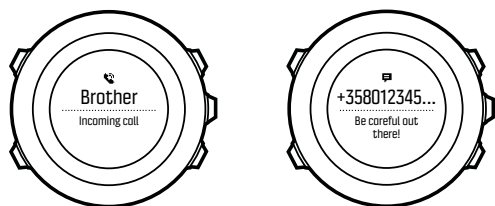

To get notifications on your watch:

1. Keep [Next] pressed to enter the options menu.
2. Press [Light Lock] to scroll to **CONNECTIVITY** and press [Next] .
3. Press [Light Lock] to scroll to **Settings** and press [Next] .
4. Press [Light Lock] to scroll to **NOTIFICATIONS** and press [Next] .
5. Toggle on/off with [Light Lock] and press [Next] .
6. Exit by keeping [Next] pressed.

With notifications on, your Suunto Ambit3 Run gives an audible alert and displays a notification icon in the bottom row with each new event.

To view notifications on your watch:

1. Keep [Next] pressed to enter the options menu.
2. Press [Light Lock] to scroll to **CONNECTIVITY** and press [Next] .
3. Scroll to **Notifications** with [Light Lock] and select with [Next] .
4. Scroll through the notifications with [Start Stop] or [Light Lock] .

Up to 10 notifications can be listed. Notifications remain in your watch until you clear them from your mobile device. However, notifications older than one day are hidden from view in the watch.

3.19. PODs and HR sensors

Pair your Suunto Ambit3 Run with a Bluetooth[®] Smart compatible foot to receive additional information during exercise.

The Suunto Smart Sensor included in your Suunto Ambit3 Run package (optional) is already paired. Pairing is required only if you want to use a different Bluetooth Smart compatible heart rate sensor.

3.19.1. Pairing PODs and HR sensors

Pairing procedures may vary depending on the POD or heart rate (HR) sensor type. Please refer to the user guide for the device you are pairing with your Suunto Ambit3 Run before continuing.

To pair a POD or heart rate sensor:

1. Activate the POD or heart rate sensor. If you are pairing a Suunto Smart Sensor, see 3.9.2. *Putting on Suunto Smart Sensor*.
2. Keep [Next] pressed to enter the options menu.
3. Scroll to **PAIR** with [Light Lock] and select with [Next] .
4. Scroll the options with [Start Stop] and [Light Lock] and press [Next] to select a POD or heart rate sensor to pair.

5. Hold your Suunto Ambit3 Run close to the device you are pairing and wait for Suunto Ambit3 Run to notify that pairing was successful. If the pairing fails, press [Start Stop] to retry, or [Light Lock] to return to the pairing setting.

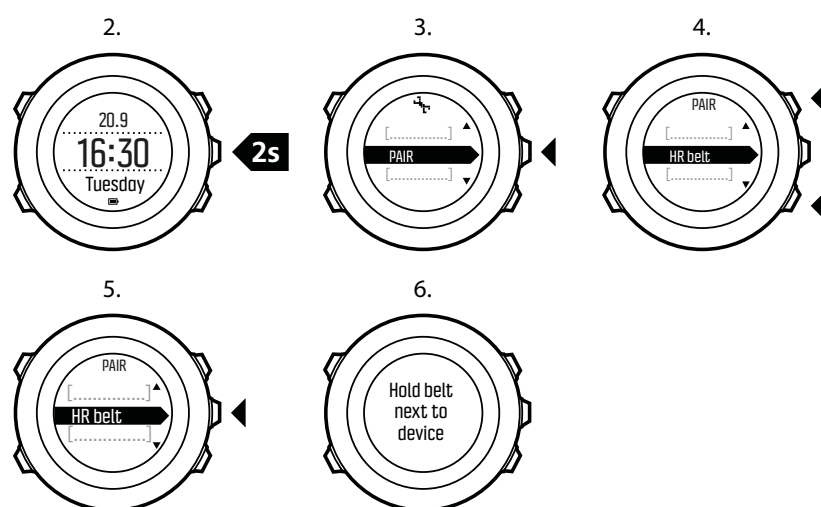

3.19.2. Using foot POD

When using a foot POD, the POD is auto calibrated by GPS at short intervals during exercise. However, the foot POD always remains the source of speed and distance when it is paired and active for the given sport mode.

Foot POD auto calibration is on by default. It can be turned off in the sport mode options menu under **ACTIVATE**, if the foot POD is paired and is used for the selected sport mode.

For more accurate speed and distance measurements, you can manually calibrate the foot POD. Perform the calibration on an accurately measured distance, for instance, on a 400 meter running track.

To calibrate foot POD with Suunto Ambit3 Run:

1. Attach foot POD to your shoe. For more information, see user guide for the foot POD you are using.
2. Choose a sport mode (for example **Running**) in the start menu.
3. Start running at your usual pace. When you cross the starting line, press [Start Stop] to start the recording.
4. Run a distance of 800–1000 meters (about 0.500–0.700 miles) at your usual pace (for example two laps on a 400 meter track).
5. Press [Start Stop] when you reach the finish line to pause the recording.
6. Press [Back Lap] to stop recording. After stopping the exercise, save the log by pressing [Start Stop]. If you do not want to save the log, press [Light Lock]. Scroll with [Next] through summary views, until you reach the distance summary. Adjust the distance shown on the display to the actual distance you ran with [Start Stop] and [Light Lock]. Confirm with [Next].
7. Confirm the POD calibration by pressing [Start Stop]. Your foot POD has now been calibrated.

 **NOTE:** *If the foot POD connection was unstable during the calibration exercise, you might not be able to adjust the distance in the distance summary. Make sure that foot POD is attached properly according to instructions and try again.*

If you are running without a foot POD, you can still get running cadence from the your wrist. Running cadence measured from wrist is used together with FusedSpeed (see 3.12. *FusedSpeed*) and is always on for specific sport modes including running, trail running, treadmill, orienteering, and track and field.

If a foot POD is found at start of an exercise, running cadence measured from wrist is overwritten by foot POD cadence.

3.20. Points of interest

Suunto Ambit3 Run includes GPS navigation which allows you to navigate to a pre-defined destination stored as a point of interest (POI).

 **NOTE:** *You can also navigate when you are recording an exercise (see 3.9.7. *Navigating during exercise*).*

To navigate to a POI:

1. Enter a sport mode that has GPS activated and keep [Next] pressed to access the options menu.
2. Scroll to **NAVIGATION** using [Start Stop] and enter with [Next] .
3. Scroll to **POIs (Points of interest)** using [Light Lock] and select with [Next] .
The watch displays the number of saved POIs and free space available for new POIs.
4. Scroll to the POI you wish to navigate to with [Start Stop] or [Light Lock] and select with [Next] .
5. Press [Next] to select **Navigate**. If you are using the compass for the first time, you need to calibrate it (see 3.6.2. *Calibrating compass*). After activating the compass, the watch starts searching for a GPS signal and displays **GPS found** after acquiring the signal.
6. Start navigating to the POI. The watch displays the following information:
7. indicator showing the direction to your target (see further explanation below)
8. your distance from the target
9. The watch informs you that you have arrived at your target.

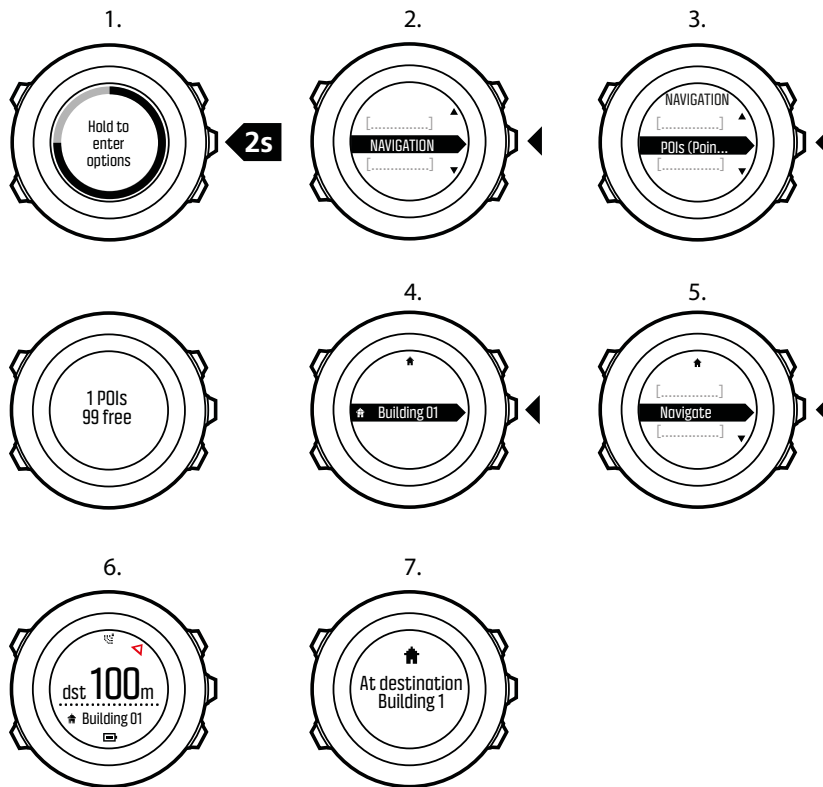

When stationary or moving slowly (<4 km/h), the watch shows you the direction to the POI (or waypoint if navigating a route) based on the compass bearing.



While moving (>4 km/h), the watch shows you the direction to the POI (or waypoint if navigating a route) based on GPS.

The direction to your target, or bearing, is shown with the empty triangle. Your direction of travel, or heading, is indicated by the solid lines at the top of the display. Aligning these two ensures you are moving in the correct direction.

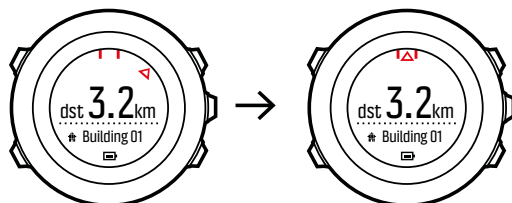

3.20.1. Checking your location

Suunto Ambit3 Run allows you to check the coordinates of your current location using GPS.

To check your location:

1. Enter a sport mode that has GPS activated and keep [Next] pressed to access the options menu.
2. Scroll to **NAVIGATION** using [Start Stop] and enter with [Next] .
3. Press [Next] to select **Location**.
4. Press [Next] to select **Current**.
5. The watch starts searching for a GPS signal and displays **GPS found** after acquiring the signal. After that your current coordinates are shown on the display.

 **TIP:** You can also check your location while you are recording an exercise by keeping [Next] pressed to access the options menu.

3.20.2. Adding your location as a POI

Suunto Ambit3 Run allows you to save your current location or define a location as a POI. You can navigate to a saved POI anytime, for example, during your exercise.

You can store up to 250 POIs in the watch. Note that also routes take up this quota. For example, if you have a route with 60 waypoints, you can additionally store 190 POIs in the watch.

You can select a POI type (icon) and POI name from a pre-defined list

To save a location as a POI:

1. Enter a sport mode that has GPS activated and keep [Next] pressed to access the options menu.
2. Scroll to **NAVIGATION** using [Start Stop] and enter with [Next] .
3. Press [Next] to select **Location**.
4. Select **CURRENT** or **DEFINE** to manually change longitude and latitude values.
5. Press [Start Stop] to save the location.
6. Select a suitable POI type for the location. Scroll through the POI types with [Start Stop] or [Light Lock] . Select a POI type with [Next] .
7. Select a suitable name for the location. Scroll through the name options with [Start Stop] or [Light Lock] . Select a name with [Next] .
8. Press [Start Stop] to save the POI.

3.20.3. Deleting a POI

You can delete a POI in the watch

To delete a POI:

1. Enter a sport mode that has GPS activated and keep [Next] pressed to access the options menu.
2. Scroll to **NAVIGATION** using [Start Stop] and enter with [Next] .
3. Scroll to **POIs (Points of interest)** using [Light Lock] and select with [Next] .
The watch displays the number of saved POIs and free space available for new POIs.
4. Scroll to the POI you wish to delete with [Start Stop] or [Light Lock] and select with [Next] .
5. Scroll to **Delete** with [Start Stop] . Select with [Next] .
6. Press [Start Stop] to confirm.

3.21. Recovery

Your Suunto Ambit3 Run provides two indicators for following your need to recover after training: recovery time and recovery status.

3.21.1. Recovery time

Recovery time is an estimate in hours of how long your body needs to recuperate after training. The time is based on the duration and intensity of the training session, as well as your overall fatigue.

Recovery time accumulates from all types of exercise. In other words, you accumulate recovery time on long, low intensity training session as well as at high intensity.

The time is cumulative across training sessions, so if you train again before the time has expired, the newly accumulated time is added to the remainder from your previous training session.

The number of hours you accumulated for a given training session is shown in the summary at the end of the session.

The total number of hours of recovery time you have remaining is shown as a view of in the activity monitoring display (see 3.1. *Activity monitoring*).

Because recovery time is an estimation only, the accumulated hours are counted down steadily regardless of your fitness level or other individual factors. If you are very fit, you may recover faster than estimated. On the other hand, if you have the flu, for example, your recovery may be slower than estimated.

To get an accurate indication of your actual recovery state, we recommend using one of the recover tests (see 3.21.2. *Recovery status*).

3.21.2. Recovery status

Recovery status indicates the amount of stress on your autonomic nervous system. The less stress you have, the more recovered you are. Knowing your state of recovery helps you optimize your training and avoid over training or injury.

You can check your recovery status with the quick recovery test or sleep recovery test, powered by Firstbeat. The tests require a Bluetooth-compatible heart rate sensor that measures heart rate variability (R-R interval), such as Suunto Smart Sensor.

Your recovery status is indicated with 0-100% result scale as explained in the table below.

Result	Explanation
81-100	Fully recovered. OK to train up to very hard intensity.
51-80	Recovered. OK to train up to hard intensity.
21-50	Recovering. Train easy.
0-20	Not recovered. Rest to recover.

 **NOTE:** Values below 50% measured on several consecutive days indicate an increased need to rest.

Test calibration

Both the sleep test and quick test need to be calibrated in order to provide accurate results.

The calibration tests define what 'fully recovered' means for your body. With each calibration test, your watch adjusts the results scale of the test to match your unique heart rate variability.

You need to perform three calibration tests for both tests. These need to be done when you have no accumulated recovery time. Ideally, you also feel fully recovered and are not ill or stressed during these calibration tests.

During the calibration period, you may get results that are higher or lower than expected. These results are indicated in the watch as your estimated recovery status until the calibration is completed.

Once you have completed the calibration, the latest result is displayed when you enter the logbook instead of recovery time.

3.21.2.1. Quick recovery test

The quick recovery test, powered by Firstbeat, is an alternative way to measure your recovery status. The sleep recovery test is a more accurate method to measure your recovery status. But for some individuals, wearing a heart rate sensor throughout the night may not be feasible.

The quick recovery test only takes a few minutes. For best results, you should lie down, stay relaxed, and not move around during the test.

We recommend performing the test in the morning after waking up. This helps ensure you get comparable results day to day.

You need to perform three tests while you are feeling well recovered and have no accumulated recovery time to calibrate the test algorithm.

The calibration tests do not need to be done in sequence, but they need to be at least 12 hours apart.

During this calibration period, you may get results that are higher or lower than expected. These results are indicated in the watch as your estimated recovery status until the calibration is completed.

To perform a quick recovery test:

1. Put on your heart rate belt and ensure the electrodes are moist.
2. Lie down and relax in a quiet environment free from disturbances.
3. Press [Start Stop] , scroll to **RECOVERY** with [Start Stop] , and select with [Next] .
4. Scroll to **Quick test** and select with [Next] .
5. Wait for the test to complete.



When the test is complete, scroll through the results with [Next] and [Back Lap] .

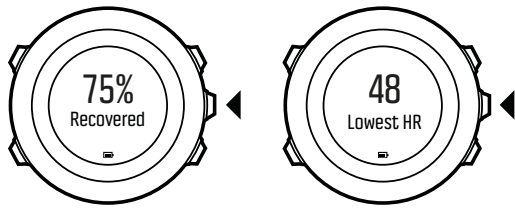

 **NOTE:** *The results of this test do not impact your accumulated recovery time.*

3.21.2.2. Sleep recovery test

The sleep recovery test, powered by Firstbeat, provides a reliable indicator of your recovery status after a night's sleep.

You need to perform three tests while you are feeling well recovered and have no accumulated recovery time to calibrate the test algorithm.

The calibration tests do not need to be done in sequence.

During the calibration period, you may get results that are higher or lower than expected. These results are indicated in the watch as your estimated recovery status until the calibration is completed.

To perform a sleep recovery test:

1. Put on your heart rate belt and ensure the electrodes are moist.
2. Press [Start Stop] , scroll to RECOVERY with [Start Stop] , and select with [Next] .
3. Scroll to **SLEEP TEST** and select with [Next] .
4. If you want to cancel the test, press [Back Lap] .
5. When you are ready to get up in the morning, end the test by pressing [Start Stop] or [Next] .

When the test is ended, scroll through the results with [Next] and [Back Lap] .

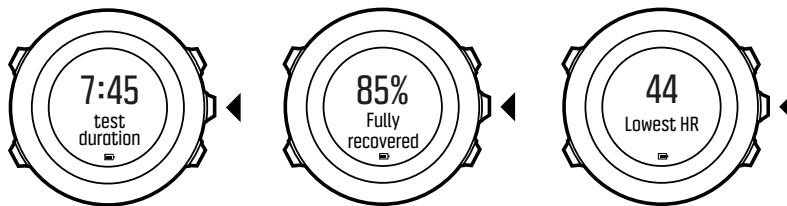

 **NOTE:** *The sleep recovery test requires at least two hours of good heart rate data to produce results. The results of this test do not impact your accumulated recovery time.*

3.22. Routes

You can create a route in Suunto app, or import a route created with another service.

To add a route:

1. Open Suunto app and create your route.
2. Sync your Suunto Ambit3 Run with Suunto app using SuuntoLink and the supplied USB cable.

Routes could also be deleted in Suunto app.

3.22.1. Navigating a route

You can navigate a route you have created in Suunto app with your Suunto Ambit3 Run (see 3.22. *Routes*) or recorded from an exercise (see 3.9.5. *Recording tracks*).

 **TIP:** You can also navigate as a sport mode (see 3.9.7. *Navigating during exercise*).

To navigate a route:

1. Enter a sport mode that has GPS activated and keep [Next] pressed to access the options menu.
2. Scroll to **NAVIGATION** with [Start Stop] and enter with [Next] .
3. Scroll to **Routes** with [Start Stop] and enter with [Next] . The watch displays the number of saved routes and after that a list of all your routes.
4. Scroll to the route you want to navigate with [Start Stop] or [Light Lock] . Select with [Next] .
5. Press [Next] and select **Navigate**. Alternatively, you can select **View** to first preview a route.
6. The watch displays all the waypoints on the selected route. Scroll to the waypoint you want to use as the starting point with [Start Stop] or [Light Lock] . Accept with [Next] .
7. If you selected a waypoint in the middle of the route, Suunto Ambit3 Run prompts you to select the direction of the navigation. Press [Start Stop] to select **Forwards** or [Light Lock] to select **Backwards**. If you selected the first waypoint as the starting point, Suunto Ambit3 Run navigates the route forward (from the first to the last waypoint). If you selected the last waypoint as the starting point, Suunto Ambit3 Run navigates the route backwards (from the last to the first waypoint).
8. If you are using the compass for the first time, you need to calibrate it (see 3.6.2. *Calibrating compass*). After activating the compass, the watch starts searching for a GPS signal and displays **GPS found** after acquiring the signal.
9. Start navigating to the first waypoint on the route. The watch informs you when you are approaching the waypoint and automatically starts navigating to the next waypoint on the route.
10. Before the last waypoint on the route the watch informs you that you have arrived at your destination.

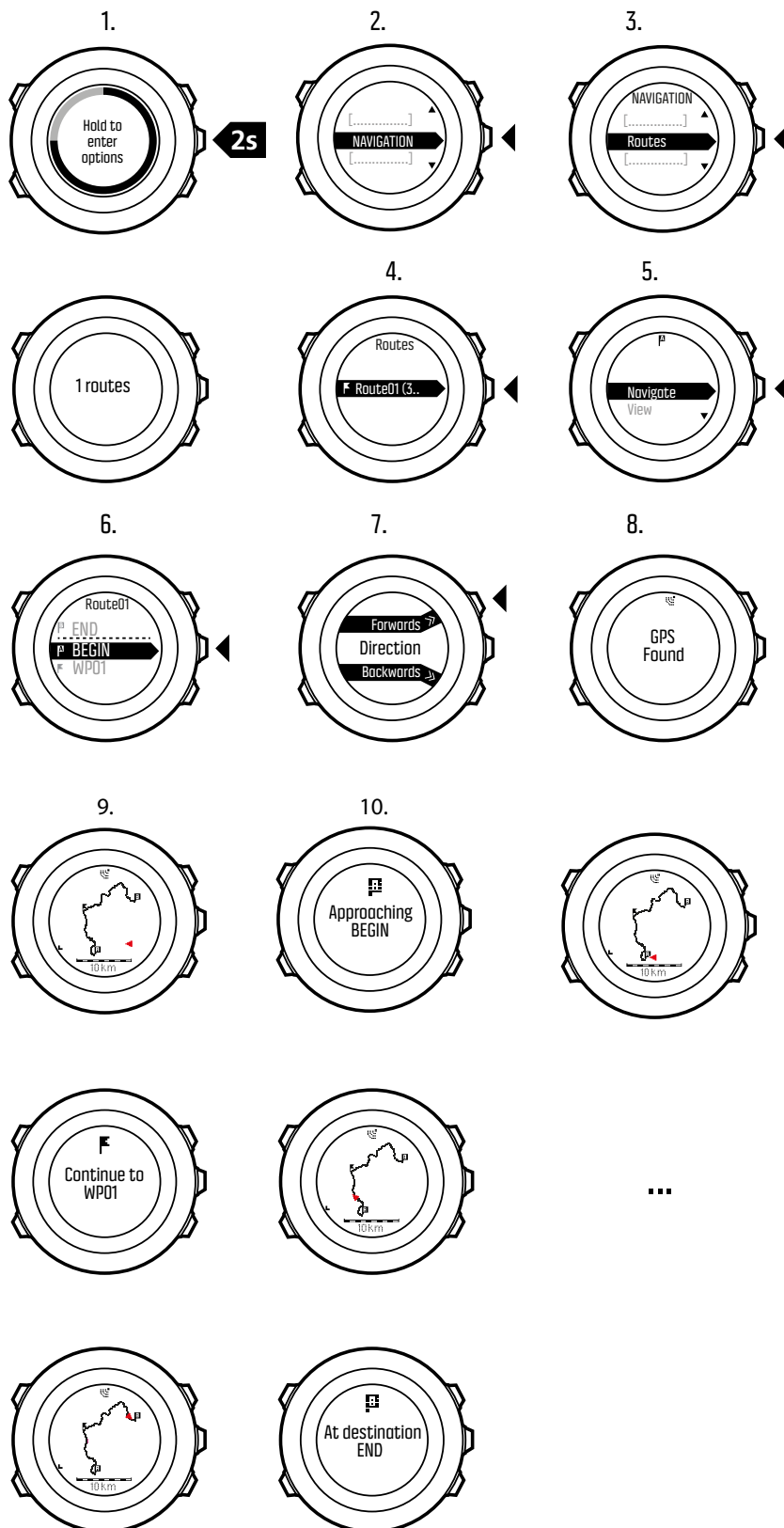

To skip a waypoint on a route:

1. While you are navigating a route, keep [Next] pressed to access the options menu.
2. Press [Next] to select **NAVIGATION**.

3. Scroll to **Skip waypoint** with [Start Stop] and select with [Next] . The watch skips the waypoint and starts navigating directly to the next waypoint on the route.

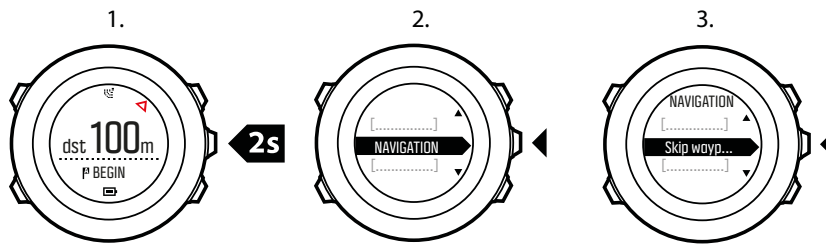

3.22.2. During navigation

During navigation, press [View] to scroll the following views:

1. the full track view showing the whole route
2. zoomed-in view of the route. You can change the map orientation in the watch settings under GENERAL » Map.
3. Heading up: Displays the zoomed-in map with the heading pointing up.
4. North up: Displays the zoomed-in map with the north pointing up.
5. waypoint navigation view

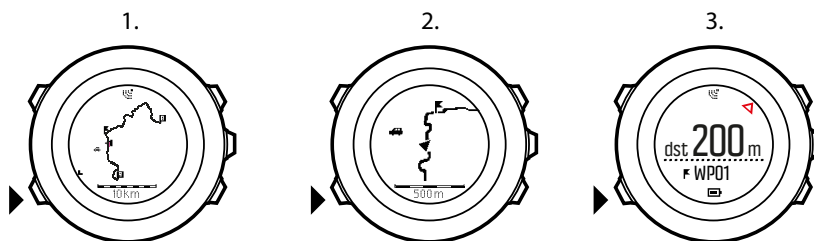

Full track view

The full track view shows you the following information:

- (1) arrow indicating your location and pointing to the direction of your heading.
- (2) the next waypoint on the route
- (3) the first and last waypoint on the route
- (4) The closest POI is shown as an icon.
- (5) scale on which the full track view is shown

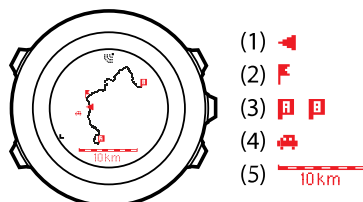

 **NOTE:** In the full track view the north is always upwards.

Waypoint navigation view

The waypoint navigation view shows you the following information:

- (1) arrow pointing to the direction of the next waypoint
- (2) your distance to the next waypoint
- (3) the next waypoint you are headed towards

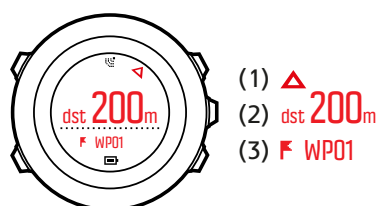

3.23. Running performance level

Running performance level is a combined measurement of your physical fitness and your running efficiency, powered by Firstbeat.

Physical fitness

Running performance level uses an estimation of your VO2max, a global standard for aerobic fitness and endurance performance. VO2max indicates your body’s maximal capability to transport and utilize oxygen.

VO2max is affected by the condition of your heart, lungs, circulatory system, and the ability of your muscles to utilize oxygen in energy production. VO2max is the most important single denominator of endurance performance of an athlete.

In addition, research has indicated that VO2max is also an important measure for health and wellbeing. At optimum running efficiency, your running performance level corresponds to your real VO2max (ml/kg/min).

MEN

Age (year)	Very poor	Poor	Fair	Average	Good	Very good	Excellent
20-24	<32	32-37	38-43	44-50	51-56	57-62	>62
25-29	<31	31-35	36-42	43-48	49-53	54-59	>59
30-34	<29	29-34	35-40	41-45	46-51	52-56	>56
35-39	<28	28-32	33-38	39-43	44-48	49-54	>54
40-44	<26	26-31	32-35	36-41	42-46	47-51	>51
45-49	<25	25-29	30-34	35-39	40-43	44-48	>48
50-54	<24	24-27	28-32	33-36	37-41	42-46	>46
55-59	<22	22-26	27-30	31-34	35-39	40-43	>43
60-65	<21	21-24	25-28	29-32	33-36	37-40	>40

WOMEN

Age (year)	Very poor	Poor	Fair	Average	Good	Very good	Excellent
20-24	<27	27-31	32-36	37-41	42-46	47-51	>51
25-29	<26	26-30	31-35	36-40	41-44	45-49	>49
30-34	<25	25-29	30-33	34-37	38-42	43-46	>46
35-39	<24	24-27	28-31	32-35	36-40	41-44	>44
40-44	<22	22-25	26-29	30-33	34-37	38-41	>41
45-49	<21	21-23	24-27	28-31	32-35	36-38	>38
50-54	<19	19-22	23-25	26-29	30-32	33-36	>36
55-59	<18	18-20	21-23	24-27	28-30	31-33	>33
60-65	<16	16-18	19-21	22-24	25-27	28-30	>30

(Shvartz E, Reibold RC: Aerobic fitness norms for males and females aged 6 to 75 years: a review. Aviat Space Environ Med; 61:3-11, 1990.)

Running efficiency

Running performance level also takes into account running efficiency, a measurement of your running technique. This measurement also takes into account external factors such as terrain, running surface, weather, and running gear.

During a run

Your Suunto Ambit3 Run provides real-time running performance feedback during your run.

The real-time feedback is available as a graph display in the default Running sport mode. You can add this graph to any sport mode that uses the running activity type. The real-time difference (see below) can also be used as a data field in your custom running sport modes.

During your run, the graph display shows your four data points, as illustrated below.

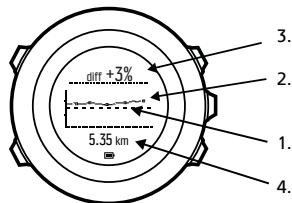

1. **Baseline:** for each run, your running performance baseline is calibrated to compensate for external variables such as terrain and to wait for your heart rate to stabilize.
2. **Real-time level:** this is your real-time running performance level for the current run displayed per kilometer/mile.
3. **Real-time difference:** this shows you the real-time difference between the calibrated running performance baseline and your real-time running performance level for the current run.
4. **Distance:** total distance for the current recording. The graph shows the last six kilometers (~4 miles).

Interpreting the results

If you are new to running or just haven't been out for a while, your running performance may be quite low at first. But as your physical fitness and running technique improve, you should see a corresponding increase in running performance.

Over a 4-20 week period, you may see an increase in running performance level up to 20%. If your running performance level is already good, it is difficult to improve further. In this situation, running performance level is better used as an endurance indicator.

Following the real-time difference indicator provides detailed, granular information on daily performance and fatigue during the run. Endurance runners can use this information to learn how much fatigue seems manageable during long intensive runs. During races, this information helps you pace yourself properly.

Illustrated below are three samples running performance levels during runs. In the first graph (1), performance is good. In the second (2), performance is bad and may indicate over training, illness, or just generally bad conditions. In the third graph (3), you see a typical long distance run where performance level drops steadily later in the run, indicate onset of fatigue.

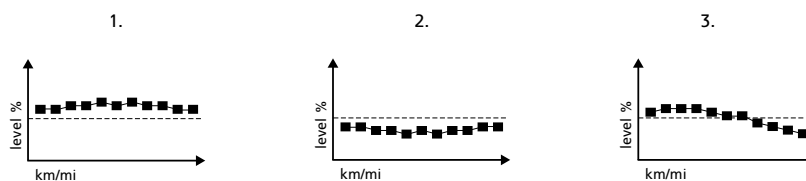

3.24. Service menu

To access the service menu, keep [Back Lap] and [Start Stop] pressed simultaneously until the watch enters the service menu.

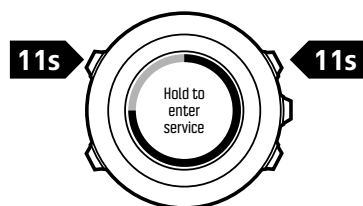

The service menu includes the following items:

- **INFO:**
 - **BLE:** shows the current Bluetooth Smart version
 - **Version:** shows the current software and hardware version
- **TEST:**
 - **LCD test:** allows you to test that the LCD works properly
- **ACTION:**
 - **Power off:** allows you to put the watch into deep sleep
 - **GPS reset:** allows you to reset GPS
 - **Clear data:** clear recovery test calibration

 **NOTE: POWER OFF** is a low power state. Connect the USB cable (with power source) to wake up the watch. The initial setup wizard starts. All settings except time and date are maintained. Just confirm them through the startup wizard.

 **NOTE:** The watch switches to power saving mode when it is static for 10 minutes. The watch re-activates when moved.

 **NOTE:** Service menu content is subject to change without notice during updates.

Resetting GPS

In case the GPS unit cannot find a signal, you can reset GPS data in the service menu.

To reset GPS:

1. In the service menu, scroll to **ACTION** with [Light Lock] and enter with [Next] .
2. Press [Light Lock] to scroll to **GPS reset** and enter with [Next] .
3. Press [Start Stop] to confirm GPS reset, or press [Light Lock] to cancel.

 **NOTE:** Resetting GPS resets GPS data, compass calibration values and recovery time. Saved logs are not removed.

3.25. Shortcuts

By default, when you keep [View] pressed in **TIME** mode, you toggle the display between light and dark. This shortcut can be changed to a different menu item.

To define a shortcut:

1. Keep [Next] pressed to enter the options menu or press [Start Stop] to enter the start menu.
2. Browse to the menu item to which you want to create a shortcut.
3. Keep [View] pressed to create the shortcut.



NOTE: Shortcuts cannot be created to all possible menu items, such as individual logs.

In other modes, keeping [View] pressed accesses predefined shortcuts. For example, when the compass is active, you can access the compass settings by keeping [View] pressed.

3.26. Sport modes

Sport modes are your way to record exercises and other activities with your Suunto Ambit3 Run. For any activity, you can select a sport mode from the set of predefined sport modes that came with your watch. If you cannot find a suitable sport mode, create your own custom sport modes in SuuntoLink.

Different information is shown on the displays during exercise depending on the sport mode. The selected sport mode also affects exercise settings, such as heart rate limits and autolap distance.

In SuuntoLink you can create custom sport modes, edit the predefined sport modes and delete sport modes.

Custom sport modes

A custom sport mode can contain 1 to 8 different sport mode displays. You can choose which data appears on each display from a comprehensive list. You can customize, for example, sports-specific heart rate limits, what PODs to search for, or the recording interval to optimize accuracy and battery duration.

Any sport mode with GPS activated can also use the **QUICK NAVIGATION** option. By default, this option is off. When you select POI or Route, you get a pop-up list of the POIs or routes you have defined in your watch at the start of your exercise.

You can transfer up to 10 different sport modes created in SuuntoLink to your Suunto Ambit3 Run.

3.27. Stopwatch

The stopwatch is a display that can be turned on or off from the start menu.

To activate the stopwatch:

1. Press [Start Stop] to enter the start menu.
2. Scroll to **DISPLAYS** with [Light Lock] and press [Next] .
3. Scroll to **Stopwatch** with [Light Lock] and press [Next] .

You can now start to use the stopwatch or press [Next] to go back to the **TIME** display. To get back to the stopwatch, press [Next] to scroll through the displays until you see the stopwatch.

To use the stopwatch:

1. In the activated stopwatch display, press [Start Stop] to start measuring time.
2. Press [Back Lap] to make a lap, or press [Start Stop] to pause the stopwatch. To view the lap times, press [Back Lap] when the stopwatch is paused.

3. Press [Start Stop] to continue.
4. To reset the time, keep [Start Stop] pressed when the stopwatch is paused.

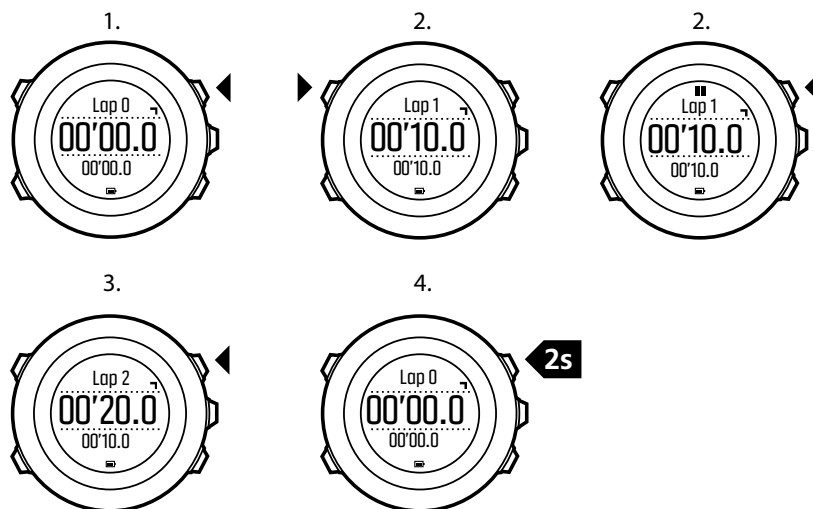

While the stopwatch is running, you can:

- press [View] to switch between the time and lap time shown on the bottom row of the display.
- switch to **TIME** mode with [Next] .
- enter the options menu by keeping [Next] pressed.

If you no longer want to see the stopwatch display, deactivate the stopwatch.

To deactivate the stopwatch:

1. Press [Start Stop] to enter the start menu.
2. Scroll to **DISPLAYS** with [Light Lock] and press [Next] .
3. Scroll to **End stopwatch** with [Light Lock] and press [Next] .

3.28. Suunto app

With the Suunto app, you can further enrich your Suunto Ambit3 Run experience by analyzing and sharing your trainings, connecting to partners and much more. Pair with the mobile app to get notifications on your Suunto Ambit3 Run.

To pair your watch with Suunto app:

1. Download and install Suunto app on your compatible mobile device from the App Store, Google Play in addition to several popular app stores in China.
2. Start Suunto app and turn on Bluetooth if it is not on already.
3. On your watch, keep [Next] pressed to enter the options menu.
4. Scroll to **PAIR** with [Light Lock] and select with [Next]
5. Press [Next] to select **MOBILEAPP**.
6. Return to the app and tap the watch icon in the upper left corner of the screen. When the name of the watch appears, tap PAIR.
7. Enter the passkey shown on your watch display into the pairing request field on your mobile device and tap PAIR to finalize the connection.

 **NOTE:** Some features require an internet connection over Wi-Fi or mobile network. Carrier data connection fees may apply.

3.28.1. Syncing with mobile app

If you have paired your Suunto Ambit3 Run with Suunto app, all your new training sessions are automatically synced when the Bluetooth connection is active and in working range. The Bluetooth icon on your Suunto Ambit3 Run flashes when data is being synced.

This default setting can be changed from the options menu.

To turn off automatic syncing:

1. Keep [Next] pressed to enter the options menu.
2. Scroll to CONNECTIVITY with [Light Lock] and select with [Next] .
3. Scroll to Settings with [Light Lock] and select with [Next] .
4. Press Next again to enter the **MobileApp sync** setting.
5. Toggle off with [Light Lock] and keep [Next] pressed to exit.

3.29. Suunto Apps

Suunto Apps allow you to further customize your Suunto Ambit3 Run. Use the sports mode customization feature in SuuntoLink to find Apps, such as various timers and counters, available for your use.

 **NOTE:** Suunto Apps in SuuntoLink refers to apps you can use in your watch. Not to be confused with Suunto app which is a mobile app used for analyzing and sharing your trainings, connecting to partners, creating routes and much more.

To add Suunto Apps to your Suunto Ambit3 Run:

1. Use the sports mode customization feature in SuuntoLink to find an app you want to use.
2. Connect your Suunto Ambit3 Run to SuuntoLink to synchronize the Suunto App to the watch. The added Suunto App will show the result of its calculation while you exercise.

3.30. Time

The time display on your Suunto Ambit3 Run shows the following information:

- top row: date
- middle row: time
- bottom row: change with [View] to show additional information such as weekday, dual time, daily step count, and battery level.

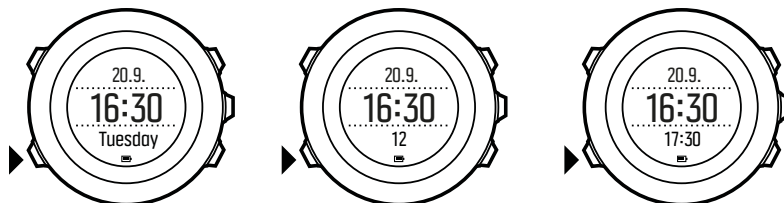

To access the time settings:

1. Keep [Next] pressed to enter the options menu.

2. Press [Next] to enter **GENERAL**.
3. Scroll to **Time/date** using [Start Stop] and enter with [Next].

Under the **Time/date** menu you can set the following:

- Time
- Date
- GPS timekeeping
- Dual time
- Alarm

To change time settings:

1. In the **Time/date** menu, scroll to the desired setting with [Start Stop] or [Light Lock] and select the setting with [Next].
2. Change the values with [Start Stop] and [Light Lock] and save with [Next].
3. Go back to the previous menu with [Back Lap], or keep [Next] pressed to exit.

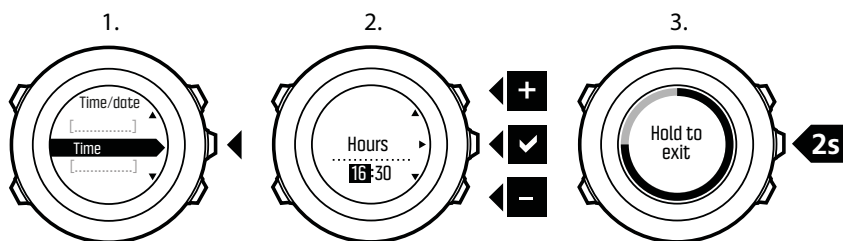

3.30.1. Alarm clock

You can use your Suunto Ambit3 Run as an alarm clock.

To access the alarm clock and set the alarm:

1. In the options menu, go to **GENERAL**, then to **Time/date** and **Alarm**.
2. Set the alarm on or off with [Start Stop] or [Light Lock]. Accept with [Next].
3. Set the hours and minutes with [Start Stop] and [Light Lock]. Accept with [Next].
4. Go back to the settings with [Back Lap], or keep [Next] pressed to exit the options menu.

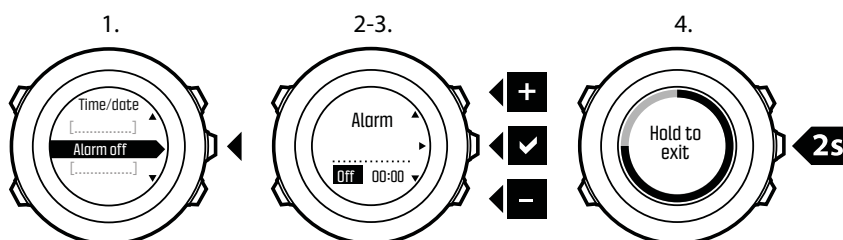

When the alarm is switched on, the alarm symbol is shown on most of the displays.

When the alarm sounds, you can:

- Select **Snooze** by pressing [Light Lock]. The alarm stops and restarts every five minutes until you stop it. You can snooze up to 12 times for a total of one hour.
- Select **Stop** by pressing [Start Stop]. The alarm stops and restarts the same time the following day, unless you switch the alarm off in the settings.

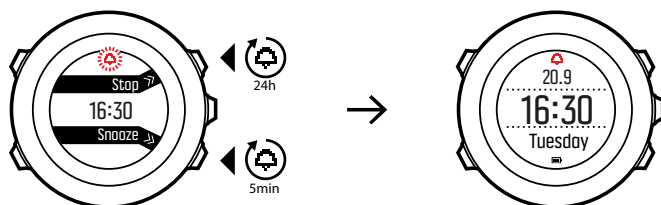

 **NOTE:** When snoozing, the alarm icon blinks in the **TIME** display.

3.30.2. Time syncing

Your Suunto Ambit3 Run time can be updated through your computer (SuuntoLink) or GPS time.

When you connect your watch to the computer with the USB cable, SuuntoLink by default updates your watch time and date according to the computer clock.

GPS timekeeping

GPS timekeeping corrects the offset between your Suunto Ambit3 Run and the GPS time. GPS timekeeping corrects the time automatically once a day, or after you have adjusted the time manually. Also the dual time is corrected.

 **NOTE:** GPS timekeeping corrects the minutes and seconds, but not the hours.

 **NOTE:** GPS timekeeping corrects the time accurately, if it is less than 7.5 minutes wrong. If the time is wrong more than that, GPS timekeeping corrects it to the closest 15 minutes.

GPS timekeeping is activated by default. To deactivate it:

1. In the options menu, go to **GENERAL**, then to **Time/date** and **GPS timekeeping**.
2. Set the GPS timekeeping on or off with [Start Stop] and [Light Lock]. Accept with [Next].
3. Go back to the settings with [Back Lap], or keep [Next] pressed to exit.

3.31. Track back

With **Track back**, you can retrace your route at any point during an exercise. Suunto Ambit3 Run creates temporary waypoints to guide you back to your starting point.

To track back during exercise:

1. While you are in a sport mode that uses GPS, keep [Next] pressed to access the options menu.
2. Press [Next] to select **NAVIGATION**.
3. Scroll to **Track back** with [Start Stop] and select with [Next].

You can now start navigating your way back the same way as during route navigation. For more information about route navigation, see 3.22.1. *Navigating a route*.

Track back can also be used from the logbook with exercises that include GPS data. Follow the same procedure as in 3.22.1. *Navigating a route*. Scroll to **Logbook** instead of **Routes**, and select a log to start navigating.

4. Care and support

4.1. Handling guidelines

Handle the unit with care – do not knock or drop it.

Under normal circumstances the watch does not require servicing. After use, rinse it with fresh water, mild soap, and carefully clean the housing with a moist soft cloth or chamois.

Use only original Suunto accessories - damage caused by non-original accessories is not covered by warranty.

 **TIP:** Remember to register your Suunto Ambit3 Run at www.suunto.com/support to get personalized support.

4.2. Water resistance

Suunto Ambit3 Run is water resistant to 50 meters/164 feet/5 bar. The meter value relates to an actual diving depth and is tested in the water pressure used in the course of the Suunto water resistance test. This means you can use the watch for swimming and snorkeling, but it should not be used for any form of diving.

 **NOTE:** Water resistance is not equivalent to functional operating depth. The water resistance marking refers to static air/water tightness withstanding shower, bathing, swimming, poolside diving and snorkeling.

To maintain water resistance, it is recommended to:

- never use the device for other than intended use.
- contact an authorized Suunto service, distributor or retailer for any repairs.
- keep the device clean from dirt and sand.
- never attempt to open the case yourself.
- avoid subjecting the device to rapid air and water temperature changes.
- always clean your device with fresh water if subjected to salt water.
- never knock or drop the device.

4.3. Charging the battery

The duration on a single charge depends on how Suunto Ambit3 Run is used and in what conditions. Low temperatures, for example, reduce the duration of a single charge. In general, the capacity of rechargeable batteries decreases over time.

 **NOTE:** In case of abnormal capacity decrease due to defective battery, Suunto warranty covers the battery replacement for one year or for at maximum 300 charging times, whichever comes first.

The battery icon indicates the charge level of the battery. When the battery charge level is less than 10 %, the battery icon blinks for 30 seconds. When the battery charge level is less than 2 %, the battery icon blinks continuously.

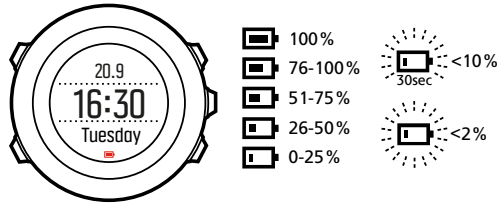

Charge the battery by attaching it to your computer with the supplied USB cable, or charge with a USB-compatible wall charger. It takes approximately 2-3 hours to fully charge an empty battery.

4.4. Replacing Smart Sensor battery

The Suunto Smart Sensor uses a 3-Volt lithium cell (CR 2025).

To replace the battery:

1. Remove the sensor from the belt strap.
2. Open the battery cover with a coin.
3. Replace the battery.
4. Firmly close the battery cover.

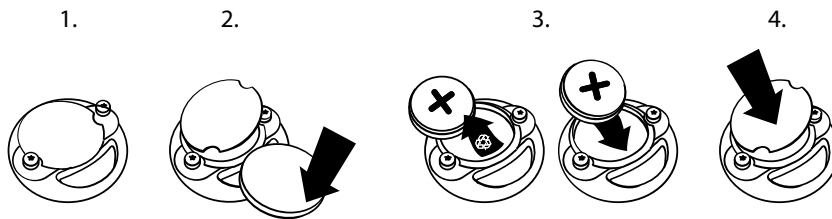

5. Reference

5.1. Technical specifications

General

- Operating temperature: -20° C to +60° C/-5° F to +140° F
- Battery charging temperature: 0° C to +35° C/+32° F to +95° F
- Storage temperature: -30° C to +60° C/-22° F to +140° F
- Weight: 72 g/2.5 oz
- Water resistance (watch): 50 meters/164 feet/5 bar
- Water resistance (HR belt): 20 m/66 ft
- Lens: mineral crystal glass
- Power: rechargeable lithium-ion battery
- Battery life: ~ 10 - 100 hours depending on selected GPS accuracy

Memory

- Point of Interest (POIs): max. 250

Radio transceiver

- Bluetooth® Smart compatible
- Communication frequency: 2402-2480 MHz
- Maximum transmission power: <0 dBm (conducted)
- Range: ~3 m/9.8 ft

Chronograph

- Resolution: 1 s until 9:59'59, after that 1 min

Compass

- Resolution: 1 degree/18 mils

GPS

- Technology: SiRF star V
- Resolution: 1 m/3 ft
- Frequency band: 1575.42 MHz

Manufacturer

Suunto Oy

Tammiston kauppatie 7 A

FI-01510 Vantaa

FINLAND

5.2. Compliance

5.2.1. CE

Hereby, Suunto Oy, declares that the radio equipment type OW143 is in compliance with Directive 2014/53/EU. The full text of the EU declaration of conformity is available at the following internet address: www.suunto.com/EUconformity.

5.2.2. FCC compliance

This device complies with Part 15 of the FCC Rules. Operation is subject to the following two conditions:

- (1) this device may not cause harmful interference, and
- (2) this device must accept any interference received, including interference that may cause undesired operation. This product has been tested to comply with FCC standards and is intended for home or office use.

Changes or modifications not expressly approved by Suunto could void your authority to operate this device under FCC regulations.

NOTE: This equipment has been tested and found to comply with the limits for a Class B digital device, pursuant to part 15 of the FCC Rules. These limits are designed to provide reasonable protection against harmful interference in a residential installation. This equipment generates, uses and can radiate radio frequency energy and, if not installed and used in accordance with the instructions, may cause harmful interference to radio communications. However, there is no guarantee that interference will not occur in a particular installation. If this equipment does cause harmful interference to radio or television reception, which can be determined by turning the equipment off and on, the user is encouraged to try to correct the interference by one or more of the following measures:

- Reorient or relocate the receiving antenna.
- Increase the separation between the equipment and receiver.
- Connect the equipment into an outlet on a circuit different from that to which the receiver is connected.
- Consult the dealer or an experienced radio/TV technician for help.

Amer Sports United States

2030 Lincoln Avenue

84401 Ogden

United States

www.amersports.com

+1 855 258 0900

5.2.3. ISED REGULATORY COMPLIANCE

This device contains licence-exempt transmitter(s) that comply with Innovation, Science and Economic Development Canada's licence-exempt RSS(s).

Operation is subject to the following two conditions:

- (1) this device may not cause interference, and

(2) this device must accept any interference, including interference that may cause undesired operation of the device.

5.2.4. NOM-121-SCT1-2009

The operation of this equipment is subject to the following two conditions: (1) it is possible that this equipment or device may not cause harmful interference, and (2) this equipment or device must accept any interference, including interference that may cause undesired operation of the equipment or device.

5.3. Trademark

Suunto Ambit3 Run, its logos, and other Suunto brand trademarks and made names are registered or unregistered trademarks of Suunto Oy. All rights are reserved.

5.4. Patent notice

This product is protected by pending patent applications and their corresponding national rights.

Watch: EP 11008080, EU designs 001332985-0001 or 001332985-0002, US 61/649,617, US 61/649,632

HR belt: US 13/071,624, US 13/832,049, US 13/832,598, US 13/917,668, US 13/397,872, USD 667,127, US 8,386,009, US 8,750,959, US 8,814,574, US 8,886,281

Additional patent applications have been filed.

5.5. International Limited Warranty

Suunto warrants that during the Warranty Period Suunto or a Suunto Authorized Service Center (hereinafter Service Center) will, at its sole discretion, remedy defects in materials or workmanship free of charge either by a) repairing, or b) replacing, or c) refunding, subject to the terms and conditions of this International Limited Warranty. This International Limited Warranty is valid and enforceable regardless of the country of purchase. The International Limited Warranty does not affect your legal rights, granted under mandatory national law applicable to the sale of consumer goods.

Warranty Period

The International Limited Warranty Period starts at the date of original retail purchase.

The Warranty Period is two (2) years for Watches, Smart Watches, Dive Computers, Heart Rate Transmitters, Dive Transmitters, Dive Mechanical Instruments, and Mechanical Precision Instruments unless otherwise specified.

The Warranty Period is one (1) year for accessories including but not limited to Suunto chest straps, watch straps, chargers, cables, rechargeable batteries, bracelets and hoses.

The Warranty Period is five (5) years for failures attributable to the depth measurement (pressure) sensor on Suunto Dive Computers.

Exclusions and Limitations

This International Limited Warranty does not cover:

1. a. normal wear and tear such as scratches, abrasions, or alteration of the color and/or material of non-metallic straps, b) defects caused by rough handling, or c) defects or damage resulting from use contrary to intended or recommended use, improper care, negligence, and accidents such as dropping or crushing;
2. printed materials and packaging;
3. defects or alleged defects caused by use with any product, accessory, software and/or service not manufactured or supplied by Suunto;
4. non-rechargeable batteries.

Suunto does not warrant that the operation of the Product or accessory will be uninterrupted or error free, or that the Product or accessory will work with any hardware or software provided by a third party.

This International Limited Warranty is not enforceable if the Product or accessory:

1. has been opened beyond intended use;
2. has been repaired using unauthorized spare parts; modified or repaired by unauthorized Service Center;
3. serial number has been removed, altered or made illegible in any way, as determined at the sole discretion of Suunto; or
4. has been exposed to chemicals including but not limited to sunscreen and mosquito repellents.

Access to Suunto warranty service

You must provide proof of purchase to access Suunto warranty service. You must also register your product online at www.suunto.com/register to receive international warranty services globally. For instructions how to obtain warranty service, visit www.suunto.com/warranty, contact your local authorized Suunto retailer, or call Suunto Contact Center.

Limitation of Liability

To the maximum extent permitted by applicable mandatory laws, this International Limited Warranty is your sole and exclusive remedy and is in lieu of all other warranties, expressed or implied. Suunto shall not be liable for special, incidental, punitive or consequential damages, including but not limited to loss of anticipated benefits, loss of data, loss of use, cost of capital, cost of any substitute equipment or facilities, claims of third parties, damage to property resulting from the purchase or use of the item or arising from breach of the warranty, breach of contract, negligence, strict tort, or any legal or equitable theory, even if Suunto knew of the likelihood of such damages. Suunto shall not be liable for delay in rendering warranty service.

5.6. Copyright

© Suunto Oy 9/2014. All rights reserved. Suunto, Suunto product names, their logos and other Suunto brand trademarks and names are registered or unregistered trademarks of Suunto Oy. This document and its contents are proprietary to Suunto Oy and are intended solely for the use of clients to obtain knowledge and information regarding the operation of Suunto products. Its contents shall not be used or distributed for any other purpose and/or otherwise communicated, disclosed or reproduced without the prior written consent of Suunto Oy. While we have taken great care to ensure that information contained in this documentation is both comprehensive and accurate, no warranty of accuracy is expressed or implied. This document

content is subject to change at any time without notice. The latest version of this documentation can be downloaded at www.suunto.com.

Index

activity monitor.....	8	interval timer.....	21
adding a route.....	33	invert display.....	14
adding current location.....	30	laps.....	17
adjust settings.....	6	logbook.....	22
alarm clock.....	43	memory left indicator.....	23
auto calibration.....	27	menu.....	39
autopause.....	8	menus.....	5
autoscroll.....	9	mode.....	9
backlight.....	9	multisport.....	21
battery.....	45	navigating.....	17, 18, 28, 34
bearing.....	12	pairing.....	26
bearing lock.....	12	paring.....	26
brightness.....	9	POD.....	26
button lock.....	10	point of interest (POI).....	28, 30
buttons.....	5	position formats.....	25
calibrating.....	12, 27	recording tracks.....	17
care.....	45	recovery.....	31
charging.....	5, 45	recovery status.....	31
compass.....	10, 11, 12, 18	recovery test.....	31
countdown timer.....	13	recovery time.....	8, 31
current location.....	29	route.....	34
declination.....	11	routes.....	33
deleting.....	30	running performance.....	37
deleting a route.....	33	service menu.....	39
display.....	14	settings.....	6, 44
displays.....	13	shortcut.....	5, 39
during exercise.....	16, 17, 18	show/hide displays.....	13
exercise.....	14, 16	sleep recover test.....	33
find back.....	18	snooze.....	43
firmware.....	18	sport mode.....	16, 22
foot POD.....	26, 27	sport modes.....	14, 40
GPS.....	24	starting exercise.....	16
GPS accuracy.....	25	startup wizard.....	5
GPS signal.....	24	stopwatch.....	40
GPS timekeeping.....	44	Suunto app.....	41, 42
grids.....	25	Suunto Smart Sensor.....	14, 15
handling.....	45	syncing.....	42
heart rate belt.....	14, 26	time.....	42, 43, 44
heart rate memory.....	14	timers.....	13
heart rate sensor.....	14, 26	troubleshooting.....	15
icons.....	20	waypoints.....	34



SUUNTO CUSTOMER SUPPORT

www.suunto.com/support

www.suunto.com/register

Manufacturer:

Suunto Oy
Tammiston kauppatie 7 A,
FI-01510 Vantaa FINLAND

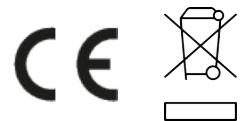

© Suunto Oy 05/2022

Suunto is a registered trademark of Suunto Oy. All Rights reserved.