







Thank you for purchasing this quality product. Be sure to unpack carefully looking for small parts which may have come loose during shipment.

Read all instruction and study the drawing carefully before starting the assembly process.

PART LIST

NO	DRAWING	DESCRIPTION	SIZE	Q' ty	NO.	DRAWING	DESCRIPTION	Q' TY
A		Wrench		1pc	①		Metal stretcher	1PC
B		Bolt under leg	147mm*Φ14mm	4pc	②		Leg	4PCS
C		Adjust leveler	Φ1/4*1"	4pc	③		Top	1PC
D		Anti-Tip Kit		1pc				

Tipping Restraint

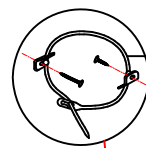

Anti-tip kit is included for use. We recommend installing for safety reason

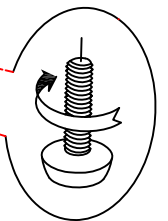
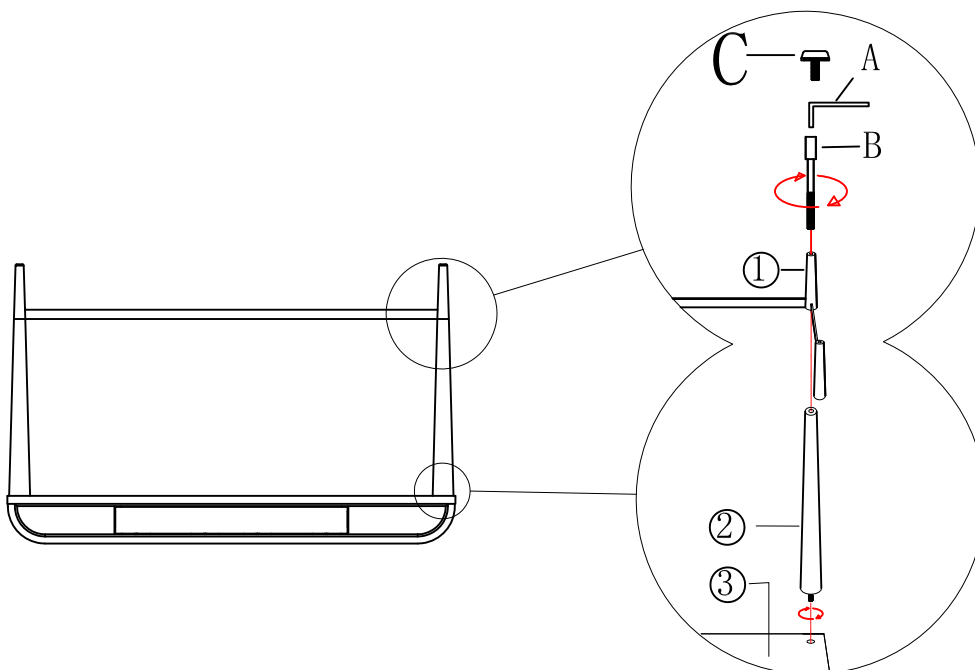
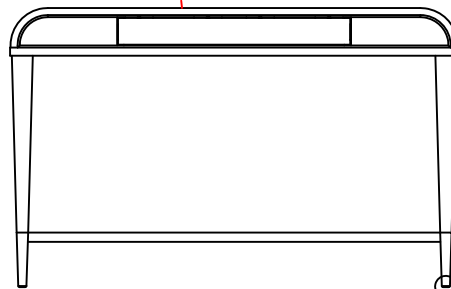

Adjust leveler if needed to level desk on uneven floor.