









ASSEMBLY INSTRUCTION

Item#: 5350-75007 Rectangle Trestle Dining Table Base
 5350-75008 Rectangle Trestle Dining Table Top w/2-22in Leaves

** Please make sure you have all parts indicated below prior to assembly.
 This unit is heavy and can best be assembled with the help of two or more people.

NO.	HARDWARE LIST		Q'TY
A		73°29*5mm ALLEN WRENCH	1
B		BOLT	8
C		LOCK WASHER	10
D		FLAT WASHER	10
E		FULL THREADED BOLT	2
F		69°27 1/2*4mm ALLEN WRENCH	1
G		NUT	2
H		SPANNER	1

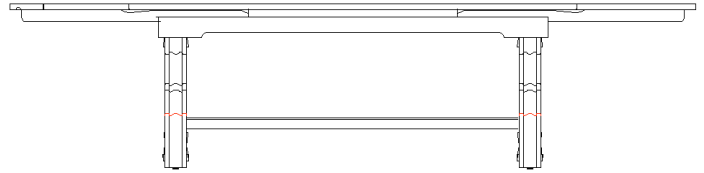

Assembly Steps:

1. Place the dining table top upside down on a soft surface to prevent it from scratching.
2. Assemble bases to the top, using flat washers(D), lock washers(C) and bolts(B), secure by turning with allen wrench(A) in a clockwise direction. Please do not tighten up bolts in this step. (See diagram 1).
3. Well insert stretcher into the holes of bases, then using flat washers(D), lock washers(C) and full threaded bolts(E), secure by turning nuts(G) with spanner(H) in a clockwise direction. Please do not tighten up full threaded bolts in this step. (See diagram 2).
4. Adjust the bases and stretcher to be at right place and then secure all bolts (B) and nuts(G) tightly now.
5. Turn the dining table upright.

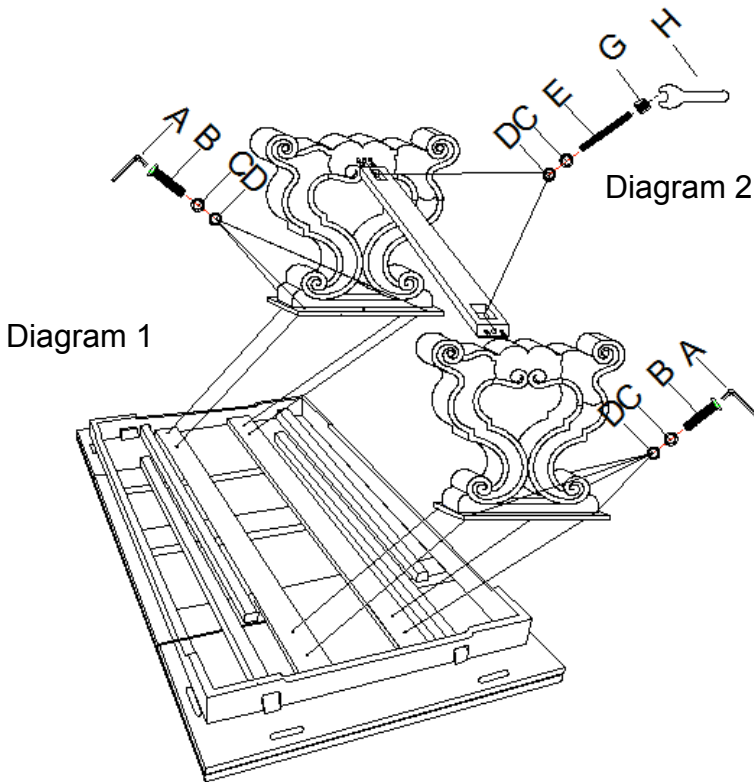

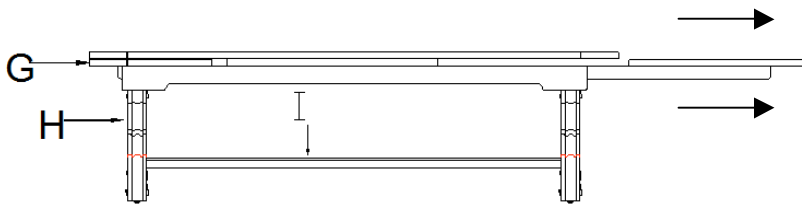

Diagram 3

Instruction for the leaves:

1. Pull out the leaves as the arrow direction shown in diagram 3.
2. Lift the leaves up and make them 1/2" higher than the center top.(See diagram 4)
3. Push and lay down the leaves as shown in diagram 5.
4. There is a latch under both sides of the leaf, unscrew the button by hand a little and push it to the bottom of top, screw the button tightly.
5. Before you put the leaves under the top, please follow the reverse way of step 4 to pull the latch back first.

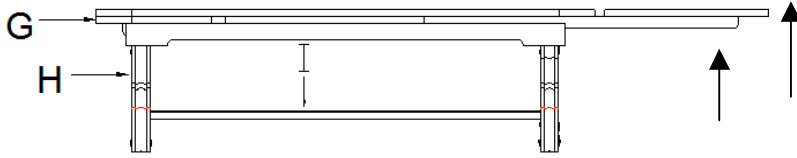

Diagram 4

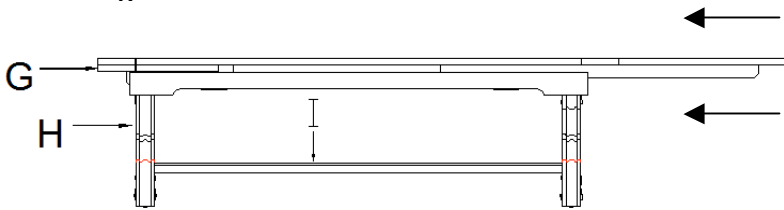

Diagram 5

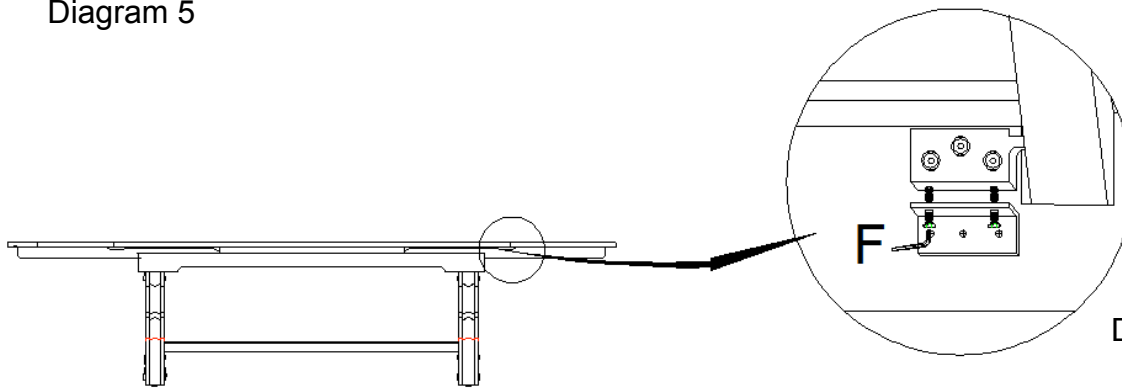

Diagram 6

You can adjust the bolts under the top if the leaves are not leveling with the top. The steps for adjusting the leaves lower and higher in order to keep it parallel with the top are listed below (See diagram 6)

1. Loosen all of the bolts at the metal block.
2. Insert allen wrench (F) through the hole on to the head of the bolt on the "L" shaped metal bracket.
3. Turn allen wrench (F) clockwise to raise the metal block, counter clockwise to low it, adjust it to keep the leaves parallel with the top.
4. Tighten all bolts on the metal block.

Cleaning Instruction: Clean finished parts with a damp cloth using a mild dishwashing liquid and water solution. Polish the finish with soft cloth and an industry recognized furniture polish.