

Jet Hand Dryer
User Manual

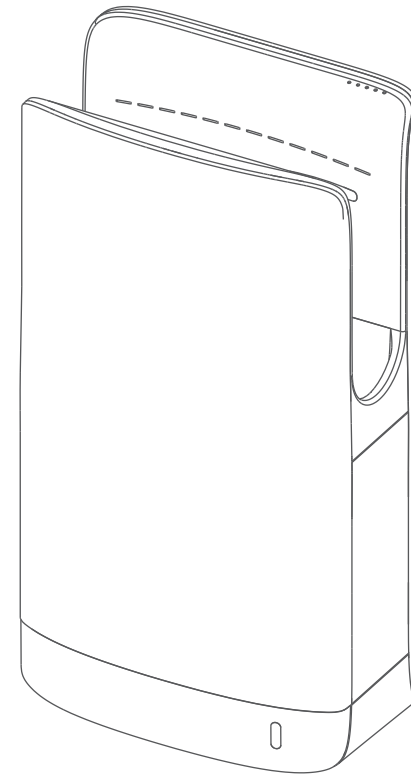







User Manual

Please read this manual thoroughly before using the hand dryer to ensure safe and correct installation or operation. Please keep this manual in a safe place for reference at a later date.

Contents

Cautions	2
Instructions	3
Features	3
Methods	3
Specifications	3
Parts Name	4
Dimensions	5
Precaution before Installation	6
Installation	8
Test Run	12
Maintenance	12
Troubleshooting	15
Electrical Schematic	16
Packing List	16

Cautions

 Prohibited	<ul style="list-style-type: none"> • Do not open the front panel — Otherwise it may cause electric shock risk. • Do not let children hanging on the unit — Otherwise the unit may be risk of falling. 	 Warning Improper use may result in personal injury accidents
 Prohibited the use in bathroom and showers	<ul style="list-style-type: none"> • Do not use In places where water is directly splashed or in places where it is prone to freezing. — Otherwise It may cause electric shock and unit malfunction. 	
 Do not spray water	<ul style="list-style-type: none"> • Do not splash water — Otherwise it may cause electric shock risk. 	
 Prohibition of disassembling	<ul style="list-style-type: none"> • Do not reform and perform unnecessary disassembling — Otherwise it may cause fire, electric shock and injury accidents. 	
 Please follow with instructions	<ul style="list-style-type: none"> • Power must be turn off during maintenance — Otherwise it may cause electric shock risk. • Please use AC power — If the rated voltage exceeds 10%, the unit will malfunction. It may cause fire, electric shock and unit malfunction if an incorrect power source is used. • Use fixed lines — If used in combination with other appliances, it may cause abnormal heat in the shunt outlet and cause fire. • Drain tank and air filter must be installed before using unit — It may cause leakage or electric shock accidents if water enters the unit. • If the unit is not working work or have abnormal conditions, please cut off the power to prevent accidents; and also to turn off the leakage circuit breaker, and then contact the supplier to check or maintenance. — Otherwise it may result in fire accidents due to electric shock, leakage, and short circuit. 	
 Warning	<ul style="list-style-type: none"> • The packaging film is easy to cause choking in the baby. Please handle it properly. • Leakage circuit breaker must be installed — Otherwise it may cause electric shock risk. • If the cord is damaged, it must be replaced by the manufacturer or professional to avoid risk. • Children or disabled persons please use this machine with the guidance or assistance of guardians. • The company does not provide warranty service for damage caused in harsh environments(such as pickle workshops), malicious cleaning(such as direct water flushing etc.) and other related conditions. If you need repair, please bear the cost yourself. • It must operated by the professional construction person when install the unit. — Incorrect construction may cause electric shock and fire accidents. 	

Instructions

Features

- Because it is a [non-touch hand drying], it is very hygienic.
- Dries wet hands quickly with high-speed airflow, and requires only a small amount of electricity, so it is very economical.
- Do not dispose of garbage, do not use towels or paper towels.
- Anti-bacterial environmental protection material without any pollution.
- Automatic heating in winter is more comfortable to dry hands, no heating in summer, dry hands are cooler.

Anti-prank timer

In order to prevent prank, the machine will automatically stop running after about 25 seconds of continuous use (with an anti-prank timer). To continue using, retract hand and put it back in again.

1 No need for air duct

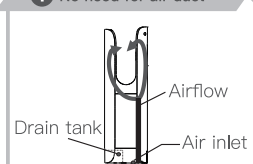

- The independent gas supply method is quite hygienic
- Water droplets do not enter the host

2 Blocking induction, U-shaped structure sensor

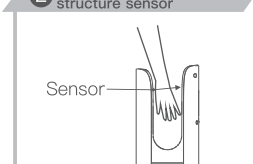

- Induction is more sensitive
- Prevent water droplets from splashing on the user's body

3 Human body angle design

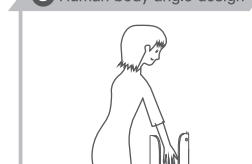

- Easy to use

Method

1

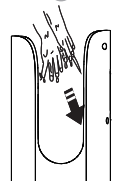

Put your hands stretched to the depths, the unit automatically starts to work.

2

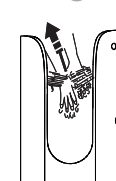

Slowly move your hands up and blow off the water on your hands

3

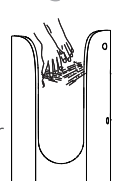

It takes about 7-10 seconds until the finger is back.

Specifications

Voltage	220V-240~	Motor	Brush motor
Input	1400-1750W	Motor Power	750W
Air Velocity	92m/s	Dimensions	296x175x556mm
Waterproof	IP24	N.W.	5.8kg

Parts Name

Parts Name

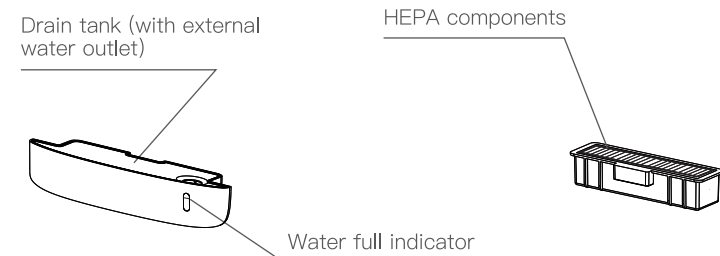
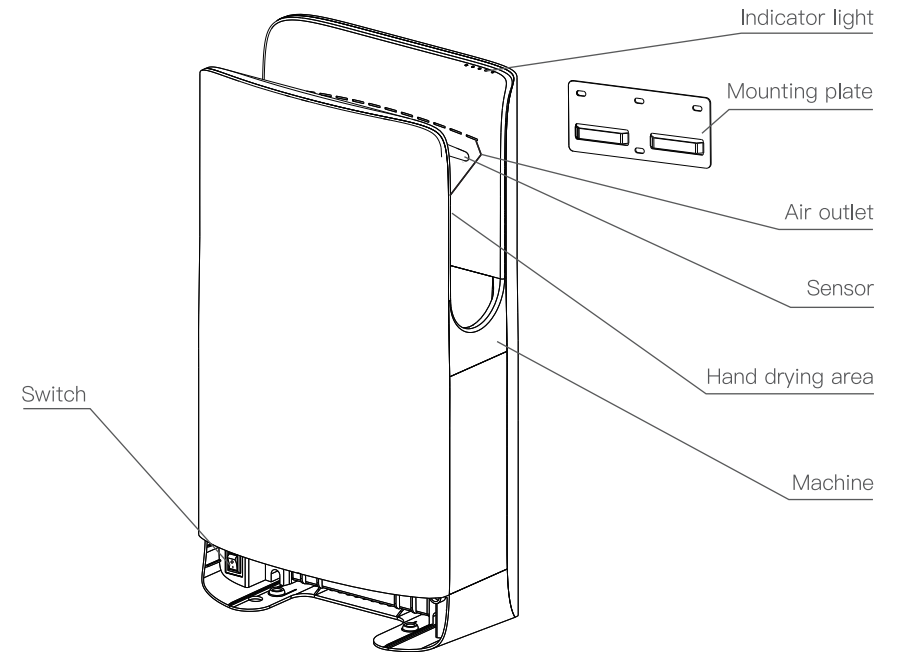

Dimensions

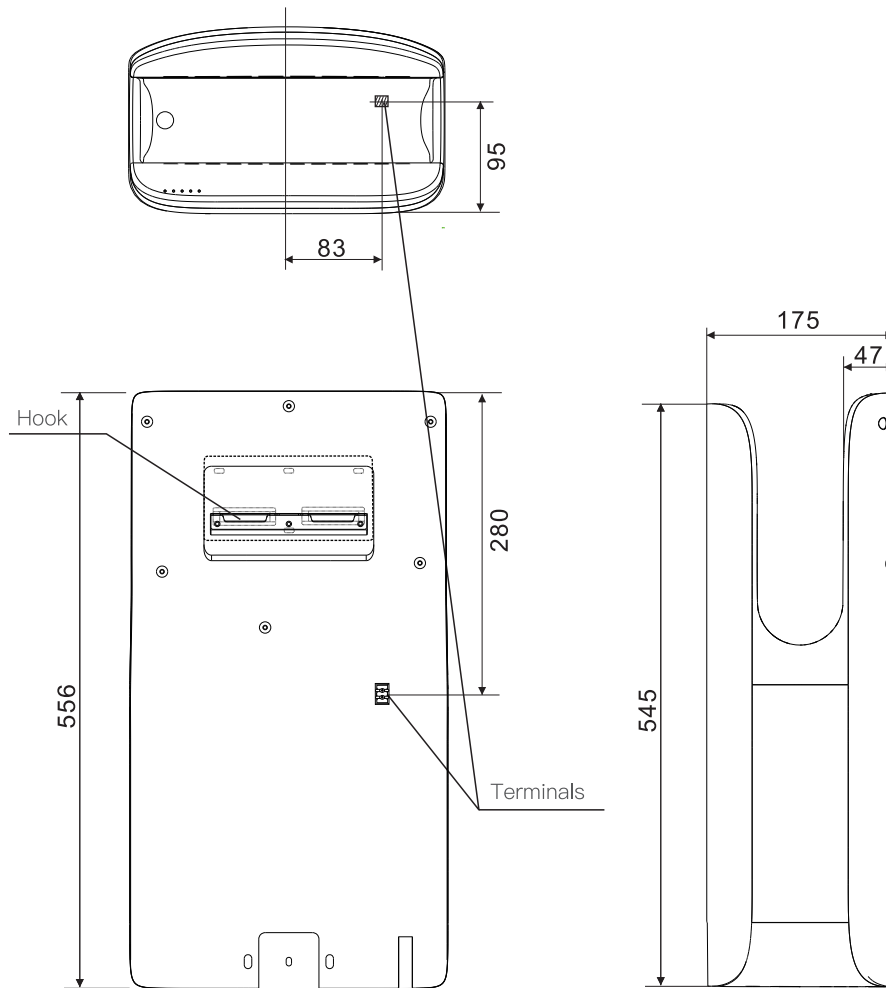

Precautions before Installation

1. Precautions before Installation

Do not install the product (power cord) with power on.

When installing the unit, it must be select a suitable place and install it by a professional.

— Otherwise there is a risk of injury due to falling of the unit.

Wear gloves when installing

— You may be injured if you do not wear gloves.



2. Do not install in the following types of location. (Otherwise this may cause malfunction)

Locations where the temperature can exceed -10°C or 40°C .

Locations where the unit may come into direct contact with water.

Locations where the unit is under direct or strong sunlight.

Locations where easy to condensation.

Locations where corrosive, neutral or reductive gases are present.

Locations where sea level lower than 0m or higher than 2000m.

3. Installation location

1. Please install the machine according to the position shown in the picture. If the unit is installed too low, water may get on it when the floor is being cleaned.
2. The left side if the unit must be at least 150mm away from any walls due to the power switch is located on the left.
3. Ensure there are no mirrors or walls near the right side, as drops of water may splatter to the right when drying hands.(Recommended distance is at least 100mm)
4. Avoid locations where people or doors might bump into the unit.
5. Choose a completely flat surface on the wall to install the unit.

Precautions before Installation

About how the machine takes electricity

- This machine is recommended to use the socket to get power, and it is necessary to install a two-hole standard socket at a distance of 20–30cm from the machine.
- If you need to connect the power cord directly, please insert the junction box without cover in the installation position.

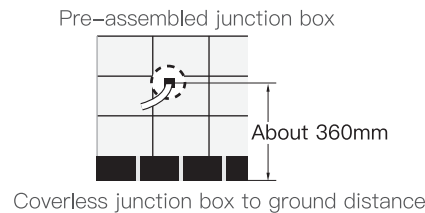
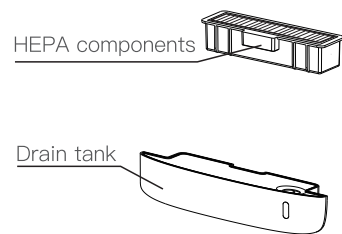
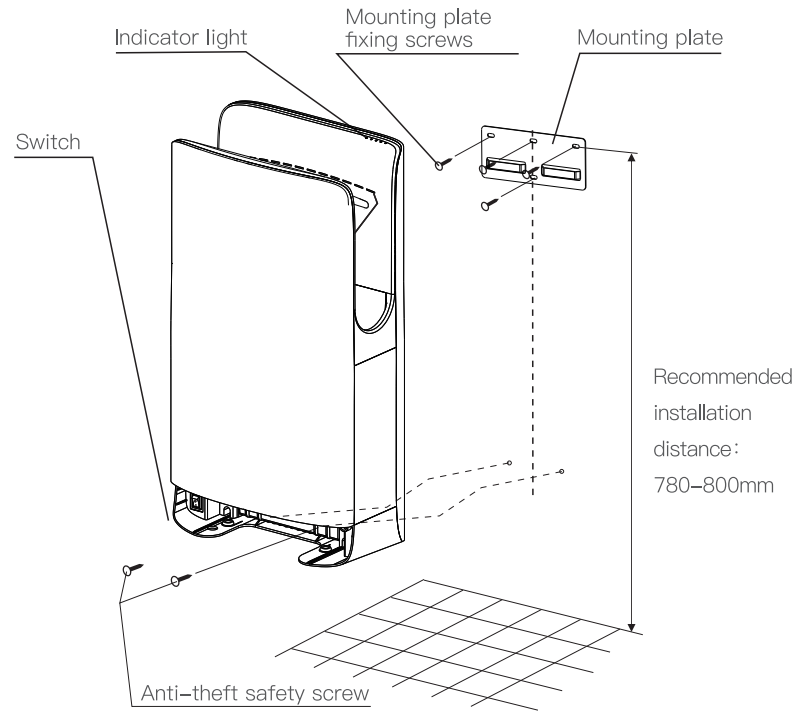

Installation Procedures

1. Please use single – phase alternating rated voltage supply!(Do not used with a power supply exceeding rated voltage $\pm 10\%$)

1. Please use 1.5mm²~2mm² for the power cord. (Single-strand wires other than 1.5mm²~2mm² cannot be used)

(If the length of the power cord exceeds 11m, please try to use a 2mm² power cord in consideration of the voltage drop problem)

2. Connect construction

- Please insert a coverless junction box at the installation location for connecting the power cord.
- If you don't use a junction box, the power cord will be pinched on the back of the case and won't fit well.

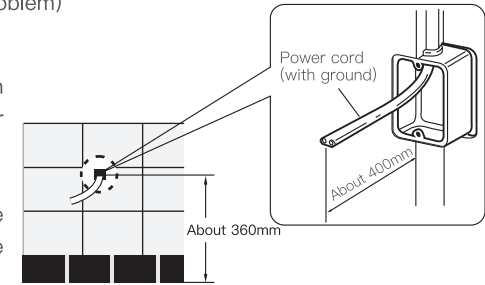

2. Fix the mounting plate on the wall with the supplied mounting plate fixing screws.

- 1.If you want to install it on a concrete wall, please use the hollow wall anchors, screws, etc. in the accessory bag of the machine for installation.
- 2.For non-concrete walls, they should be reinforced before installation.
- 3.In case of wiring installation, pay attention to the hole position on the sticker and the position of the junction box.
- 4.Paste the accompanying drilling sticker on the wall as shown in the figure. The sticker should be pasted flat on the wall. Drill four mounting plate fixing holes and two anti-theft screw holes according to the holes on the sticker.
- 5.Insert the hollow wall anchors into the six drilled holes, and fix the mounting plate as shown in the figure.

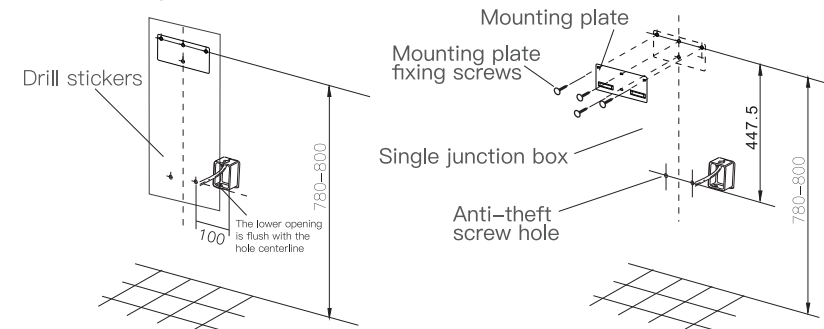

Installation Procedures

3. Remove the drain tank and Haipa assembly

If the socket is used for power supply, you can directly hang the machine, screw in the anti-theft screw, and then install the Haipa component and drain box.

If you need to connect the power directly, follow the procedure below.

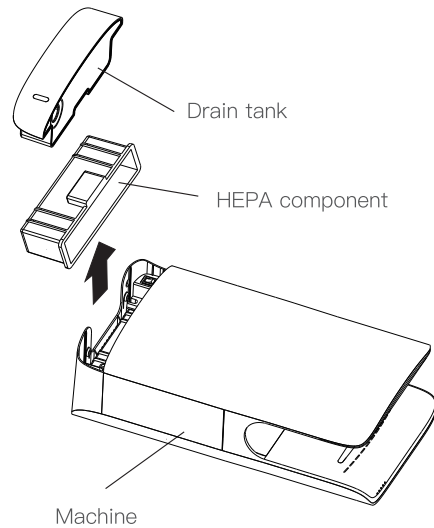

Installation Procedures

4. Wiring and then fastening the body

1. Cut off the plug of the power cord on the machine and leave the length of the power cord at about 30CM.
2. Hang the back of the body on the hook of the mounting plate (2 places).
3. Pull the power line on the machine and the junction box to the side. The live line is connected to the live line, the zero line is connected to the zero line, and the ground wire is connected to the ground wire.
4. Sort out the power cord, plug it into the junction box as far as possible, and then push the machine gently towards the wall. If the machine is not installed in place, the anti-theft screw is not easy to screw in.

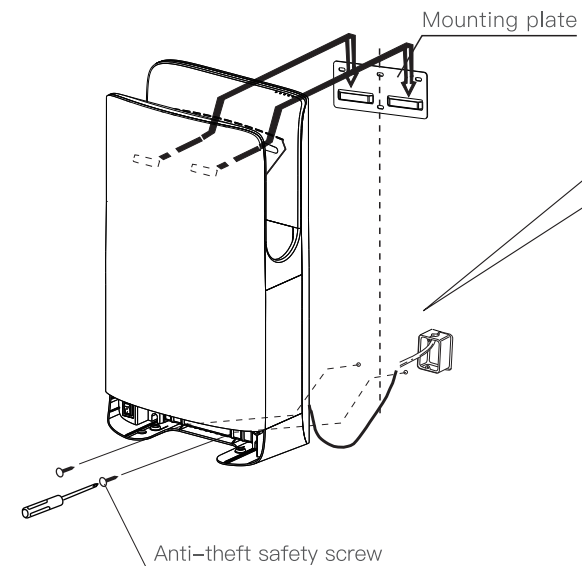

Note

After confirming that the machine has been hung on the mounting plate, the anti-theft safety screw below should be tightened, otherwise the machine may fall off or be stolen.

Installation Procedures

5. Install the front panel

1 Install HEPA components

Push the air filter into the body and make sure it is in place.

2 Install the drain box

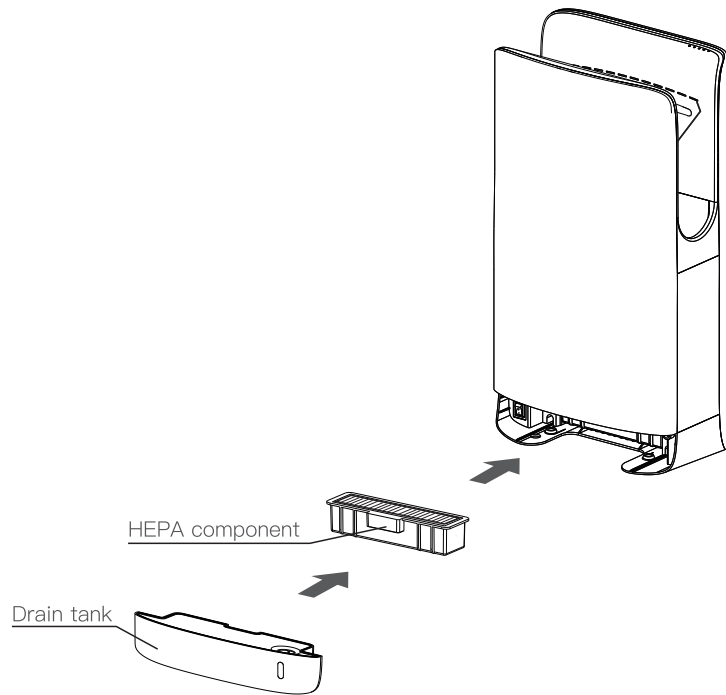

Test Run and Maintenance

Test Run

Step	Check	Result
Check the power supply voltage	Is it a 220V single-phase AC power supply?	
Turn on the earth leakage circuit breaker		
Set the power switch to [On]	Is the power indicator in the display section lit?	
Reach in for hand drying	Is the wind blowing?	
	Is the installation of the body reliable, and is there any vibration or abnormal noise?	

External maintenance of the machine

Before there is obvious contamination

On the surface of the antibacterial filter part (air filter), it exerts its antibacterial effect when bacteria are attached.

If the surface dirt is too thick, it will affect the antibacterial effect.

- Wipe with a well wrung cloth**
 — If it is very dirty, wipe it with a cloth dampened with neutral detergent, and then wipe it with a dry cloth.
- Remove dirt from the sensor section**
 — In order to prevent malfunction, the power should be turned off.

Warning

When performing maintenance, be sure to cut off the power supply and do not splash water on the machine.

Notice

Wear gloves during maintenance

Attention Please

- Please use neutral detergent**
- Please do not use organic solvents, acidic or alkaline toilet detergents, nylon brushes, etc. for cleaning.**
 — (Otherwise it will damage the surface finish of the machine).
- Only the part where the hand reaches can be cleaned and disinfected with alcohol. (Please do not use it outside the part where your hand reaches)**
 — Alcohol refers to alcohol for disinfection (with a concentration of 83% or less).
- If you use chemical wipes, please confirm the precautions for its use.**

Maintenance

Drainage and cleaning of the drain tank

Before the water is full (more than once a week)

The water blown off the hands is called “drain tank”. Empty the drain water at any moment, in order to prevent accumulated water from exceeding the full level. It will start smelliness if the accumulated water remains in the tank for too long time.

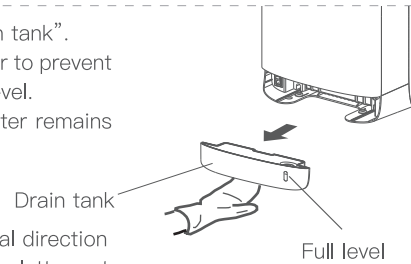

Pull the drain tank out in the horizontal direction to ensure the drain water does not splatter out.

1

Open the cover of the drain tank

Pull the cover up with your fingers in the two corners of the cover, and then remove the cover completely.

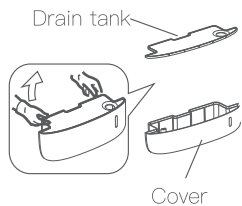

3

Close the drain tank cover, and re-attach it to the unit as original

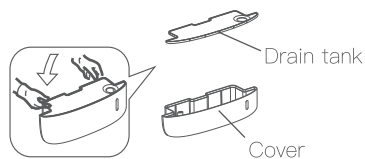

2

Wash out the interior of the drain tank

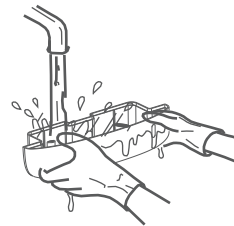

4

Add 200cc (around 1 cup) of water through the drain hole.

(To prevent it from getting clogged)
Use the unit after confirming that the drain tank is in place.

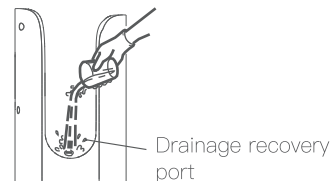

Maintenance

Cleaning the HEPA

When the wind speed drops significantly or not less than once every six months

1

Remove the air filter

Pull out the drain box first, hook the hook on the HEPA component frame with your fingers, and pull the component out horizontally.

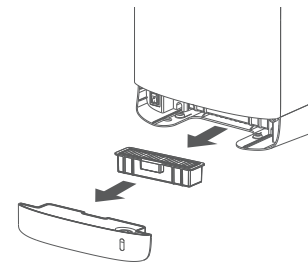

2

Cleaning the air filter

Beat it lightly by hand or use a vacuum cleaner;
It can also use hairbrush to wipe off dust;
Air filter can directly be cleaned with water, reuse after dry.

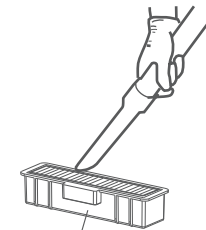

HEPA components

⚠ Please note: If washing with water, it must be dried before use.

3

Re-attach to the unit

Insert it all the way in, until it stops. (If air filter is not in place, the dirt or dust will enter the unit to shorten its service life and decreased the anti-bacterial result.)

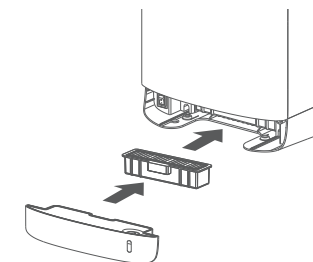

Trouble Shooting

Drainage and cleaning of the drain tank

If you discover the following circumstance, please inspection and handling as following:

Problem	Check	Action
No air flow if hands are inserted	Do the display indicators light up?	Turn the ground-fault circuit breaker on.
	Is there a power outage?	Turn the power switch on.
	Are you putting your hands all the way in?	Put hands all the way in.
Unit works a long time after hands drawn out	Any dirt or other objects on the sensor?	Switch off the power button, and then remove dirt or foreign body on sensor after the power light gone out. When finished, switch on power button.
No hot wind	Is the ambient temperature too high?	This product has a built-in temperature control probe. When the ambient temperature is $\geq 25\text{ }^{\circ}\text{C}$, the heater will stop heating.
<p>If the above actions do not work, turn off the power and the ground-fault circuit breaker, and call your sellers to inspect and repair it if necessary.</p>		

Electrical Schematic and Packing List

Electrical Schematic

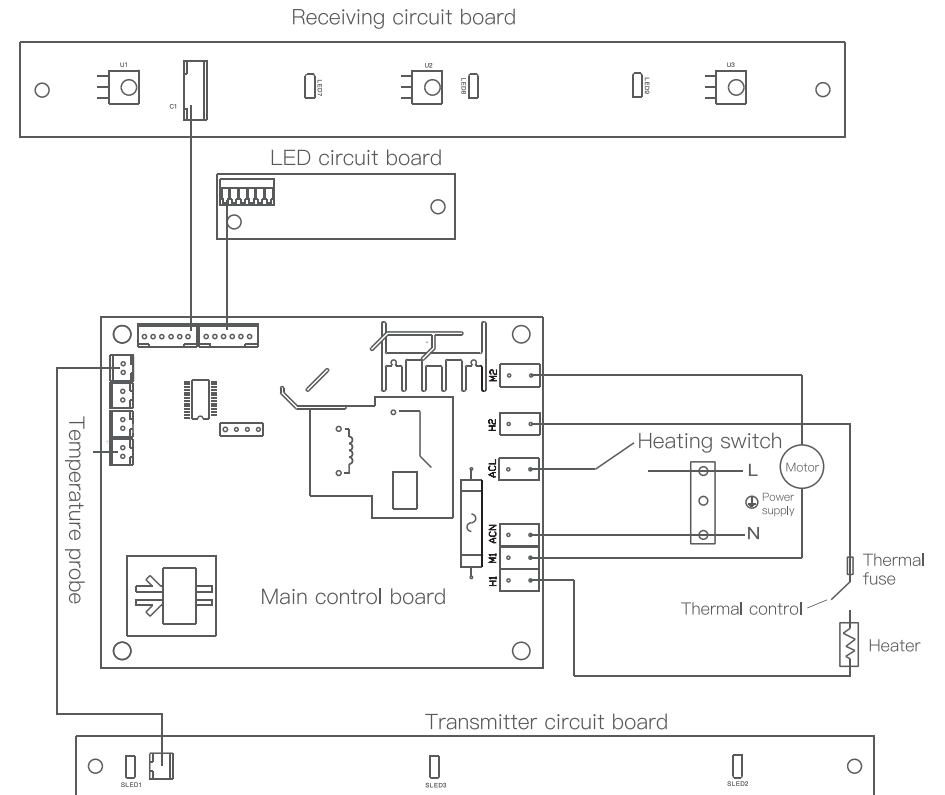

Packing List

Unit *1	Air filter *1	5mm Expansion pipe *6
5*25 Self – tapping screw *6	User manual *1	Mounting plate *1