

ML-MC3518XR-18C

ML-MC-XR series



Drawing No. A23517

レンズ形式	Lens Type	CCTV Lens	
フォーカス位置	Focus Position	Reference Magnification	M.O.D
光学倍率	Magnification	0.090	0.251
焦点距離 (mm)	Focal Length	35.00	35.00
Fno	Fno	1.80~16.00	
NA	Numerical Aperture	-	-
WD/OD (mm)	Working/Object Distance	400.0 / 403.5	150.0 / 153.5
O/I (mm)	Object to Image Distance	452.67	208.27
鏡筒長 (mm)	Mechanical Tube Length	43.31~49.51	
レンズバック (mm)	Lens Back	21.67	27.27
被写界深度 (mm)	DOF @PCoC ϕ 0.04mm	19.415	2.845
分解能 (μ m)	Resolution @ λ =550nm	-	-
前側/後側主点位置 (mm)	Front/Rear Principal Position	20.81 / -16.45	20.81 / -16.45
入射/出射瞳位置 (mm)	Entrance/Exit Pupil Position	20.73 / -16.53	20.73 / -16.53
入射/出射瞳径 (mm)	Entrance/Exit Pupil Diameter	19.40 / 19.44	19.40 / 19.44
画角 (deg.) H x V	Angle Of View	23.04 x 17.42	20.20 x 15.17
TVディストーション (%)	TV Distortion	0.065	-0.140
周辺光量比 (%)	Relative Illumination	47.53	57.24
質量 (g)	Weight	80	
マウント	Mount	C Mount	
イメージサークル径 (mm)	Image Circle	ϕ 19.3	
最大適合カメラ	Largest Compatible Camera	1.2 Inch	

ML-MC3518XR-18C

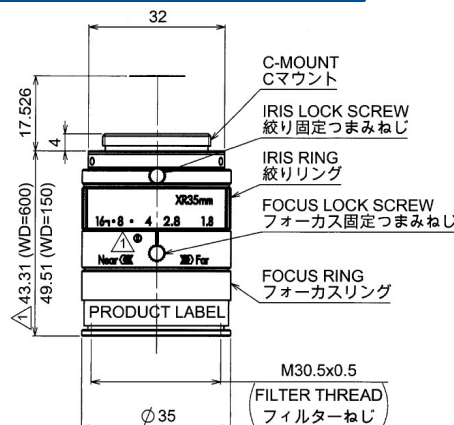

WD=400.0mm Fno2.8

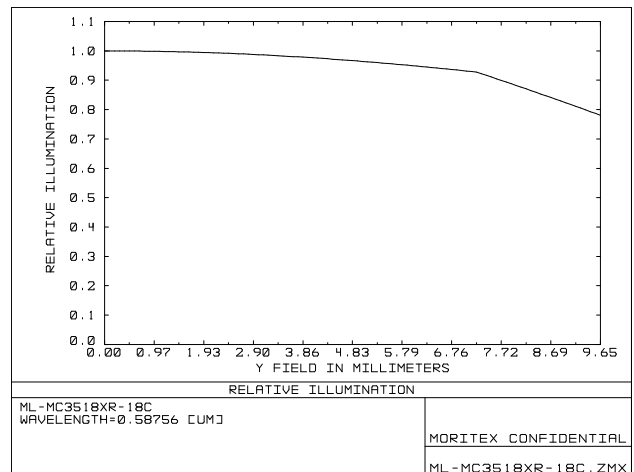
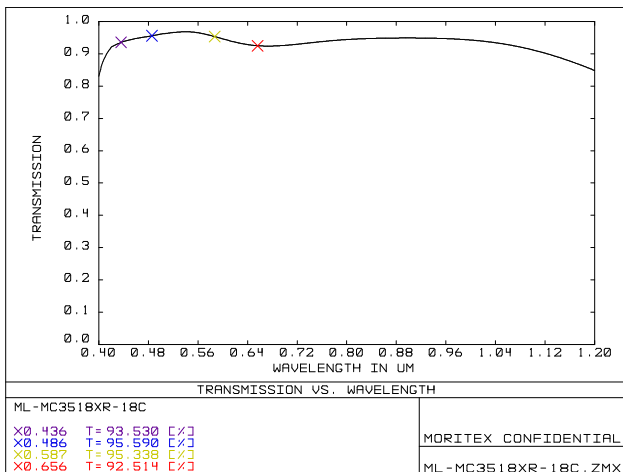
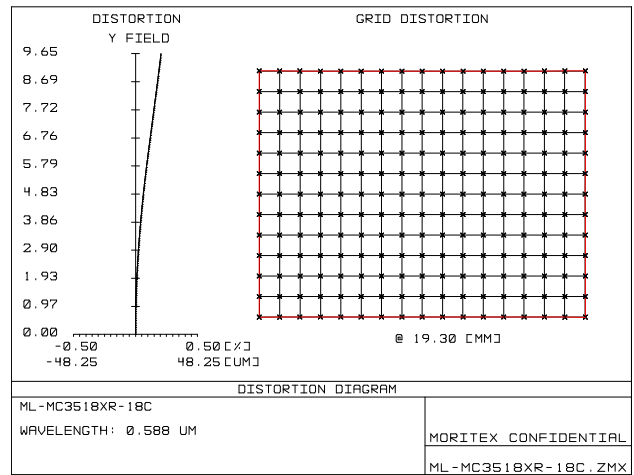
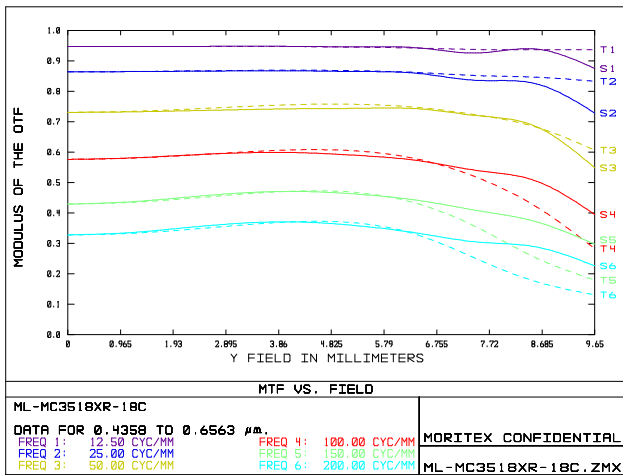

内容は、通知なしに随時変更されることがあります。

The content is subject to change at any time without notification.

株式会社 **モリテックス** MORITEX Corporation

レンズ開発部

Technology center Lens design & Development technology

TEL +81 (0)48-218-2536 moritex.mvs@moritex.com

FAX +81 (0)48-462-6713 www.moritex.com



WD=150.0mm Fno2.8

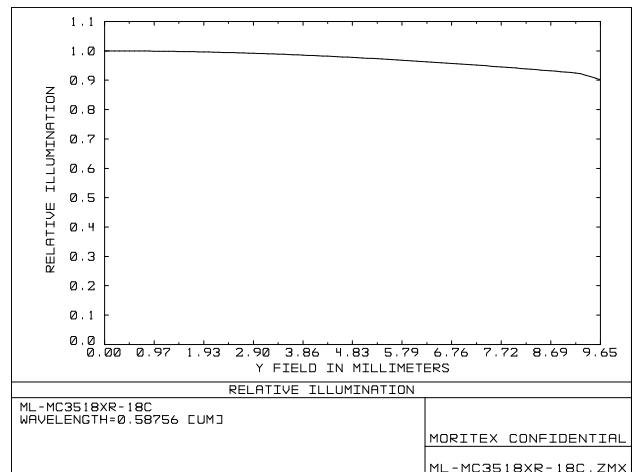
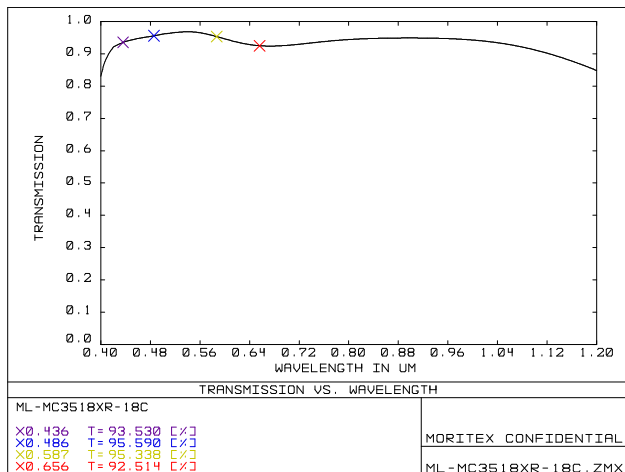
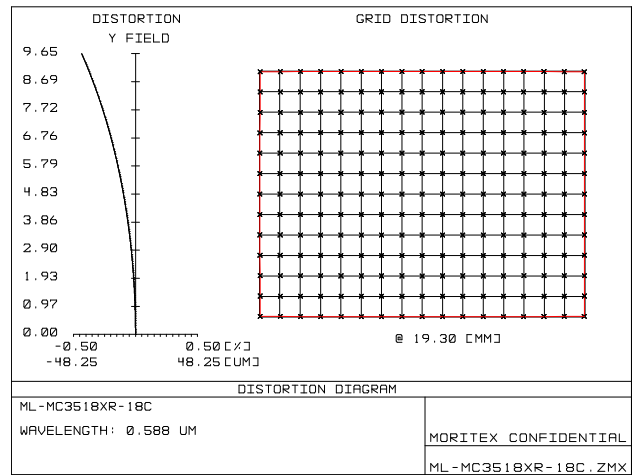
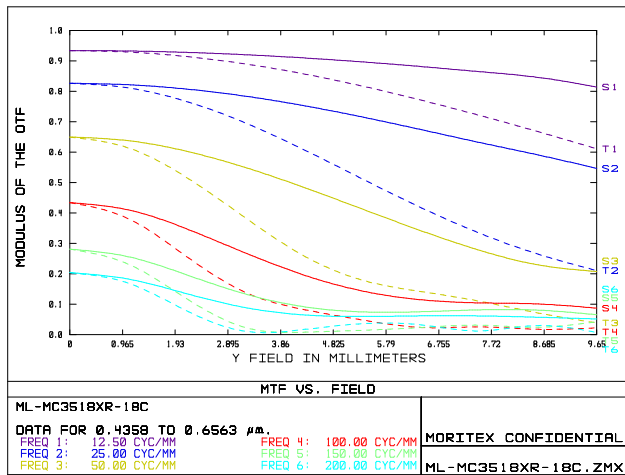

内容は、通知なしに随時変更されることがあります。

The content is subject to change at any time without notification.

株式会社 **モリテックス** MORITEX Corporation

レンズ開発部

Technology center Lens design & Development technology

TEL +81 (0)48-218-2536 moritex.mvs@moritex.com

FAX +81 (0)48-462-6713 www.moritex.com



WD=600.0mm Fno2.8

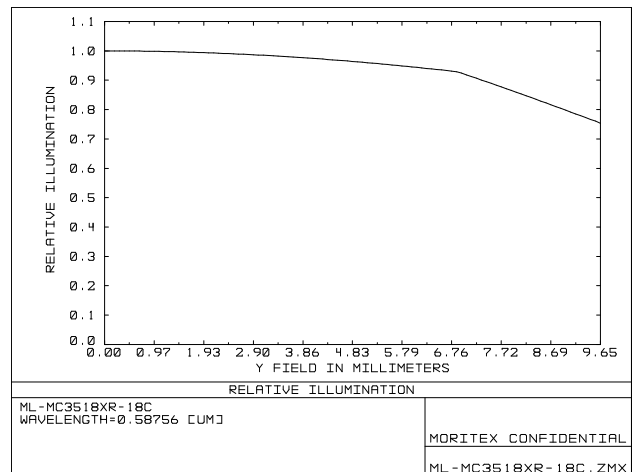
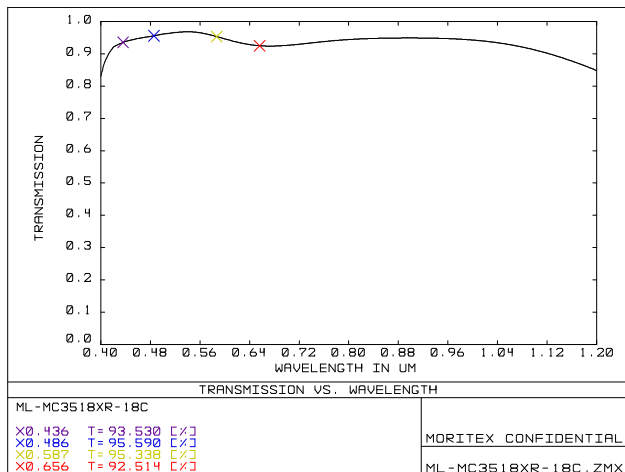
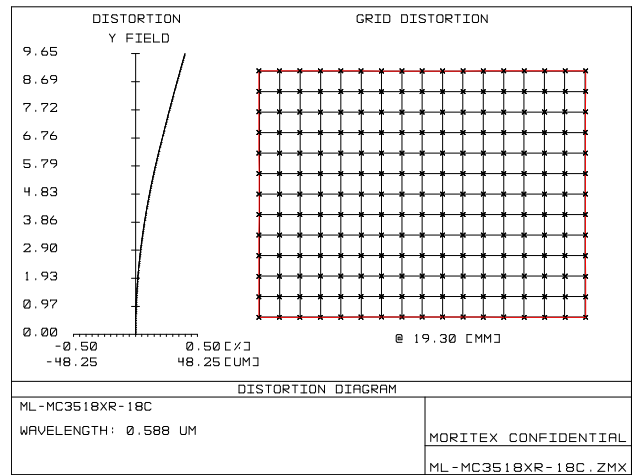
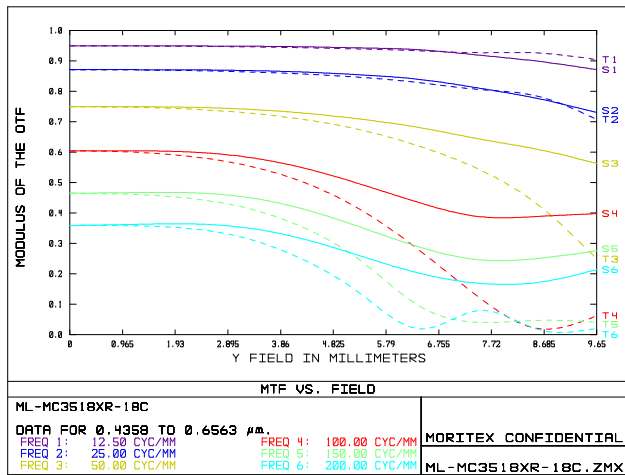

内容は、通知なしに随時変更されることがあります。

The content is subject to change at any time without notification.

株式会社 **モリテックス** MORITEX Corporation

レンズ開発部

Technology center Lens design & Development technology

TEL +81 (0)48-218-2536 moritex.mvs@moritex.com

FAX +81 (0)48-462-6713 www.moritex.com

