

CONTENTS

Motorcycle Identification Chart with Key	i,ii,iii
Moped Identification Chart	iv
A Brief History of the Motorcycle	1
Investigation of Motorcycle Thefts	3
Motorcycle Records	6
VIN Systems10
AJS15
ARIEL15
BMW16
BSA19
BENELLI21
BRIDGESTONE22
BULTACO23
CAGIVA27
CAN--AM28
CAPRIOLA	30
DUCATI31
FANTIC32
GREEVES33
GUAZZONE	34
HARLEY-DAVIDSON35
HODAKA	52
HONDA54
HUSQVARNA87
INDIAN88
JAWA/CZ90
KAWASAKI	91
LAVERDA	105
MAICO	106
MATCHLESS	107

CONTENTS - Cont'd.

MONTESA	108
MOTO BETA (MB)	109
MOTO GUZZI	110
MZ	114
NORTON	115
OSSA	116
PENTON (KTM)	118
RICKMAN	119
ROYAL ENFIELD	120
SUZUKI	121
TRIUMPH	130
VELOCETTE	133
VESPA	134
YAMAHA	136
YANKEE	159

These charts show the approximate location of engine and frame numbers for all motorcycles listed in this book and for mopeds. If you should encounter a vehicle not listed in this publication, it is suggested that you check all the points shown here. Chances are very good you will find the numbers you are searching for.

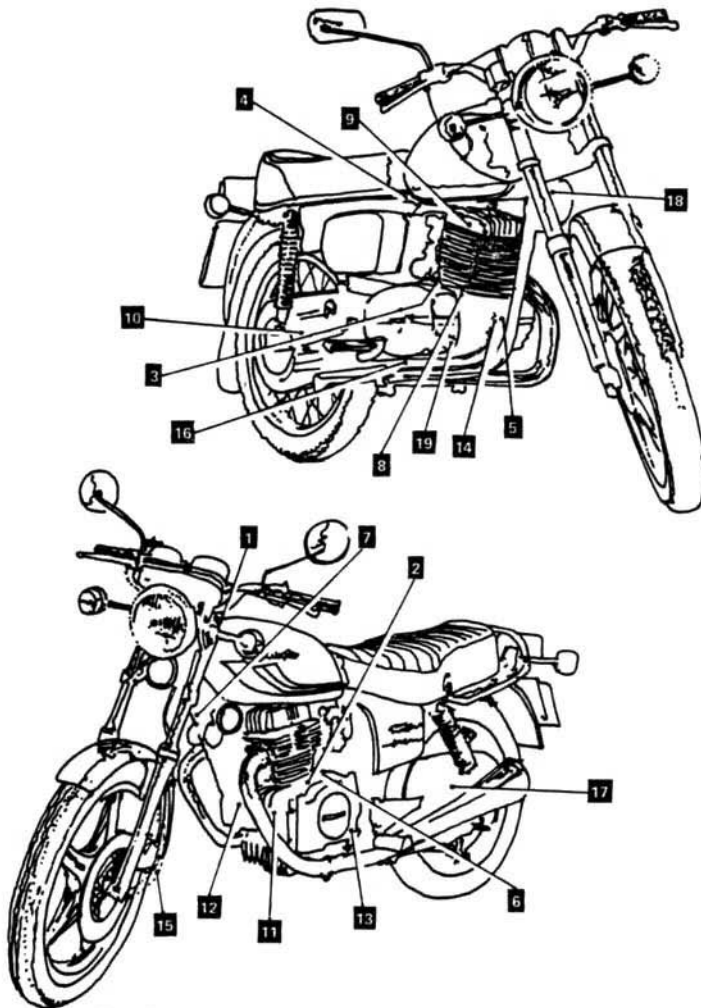

1. Headstock.
2. Left side of crankcase below cylinder.
3. Top of crankcase behind cylinder.
4. Frame X member below junction of saddle and gas tank.
5. Front of crankcase.
6. Top of left side of crankcase.
7. Left side of downtube below headstock.
8. Top of crankcase below cylinder, right side.
9. On cylinder head.
10. Right side rear for, forward of wheel hub.
11. Front of left crankcase.
12. Front left downtube.
13. Recess, under left crankcase.
14. Right side radiator frame.
15. Left side of fork to fender extension.
16. Underside of right crankcase.
17. Left side rear for, forward of wheel hub.
18. Right side of down tube below headstock.
19. Right side of crankcase.

	Frame # (Plate)	Frame # (Stamped)	Engine # (Stamped)
Ariel	1	1	2
AJS		1	2
BMW	1,10	1,18	6,8
Benelli	7	1	5,11
Bridgestone	10		8
BSA		1,7,12	2
Bultaco		1	8
Cagiva	1	1	
Can Am		1	26,5
Capriola		7	2
Fantic			4,3 (Plate)
Gilera		4	3
Greeves		1	2,8
Guazzone		12	11
Harley Davidson	1	1	5,8,2,19,16
Honda	1,6,14	1	6,3,13
Hodaka	7	12	19
Husqvarna		1	19
Indian		1,17	3,6,2
Jawa (C/Z)	1		3,6
Kawasaki	1	1	3,6
Laverda	1	1	3,9
Maico		1	19
Matchless	1	1,7	2,6
Monark		1	
Montesa		1	5,3
Moto Beta (MB)		18,17,10	3,19
Motoguzzi		1	8
MZ	1	1	15 (Plate)
Norton	1	1	2
Penton		1	
Rickman		1	6,3,13,5
Royal Enfield		1	2
Suzuki	1	1	5,6
Triumph	1	1,7	2
Velocette		4	6,11
Vespa		12	16
Yamaha	1	13	6,8
Yankee		1	2

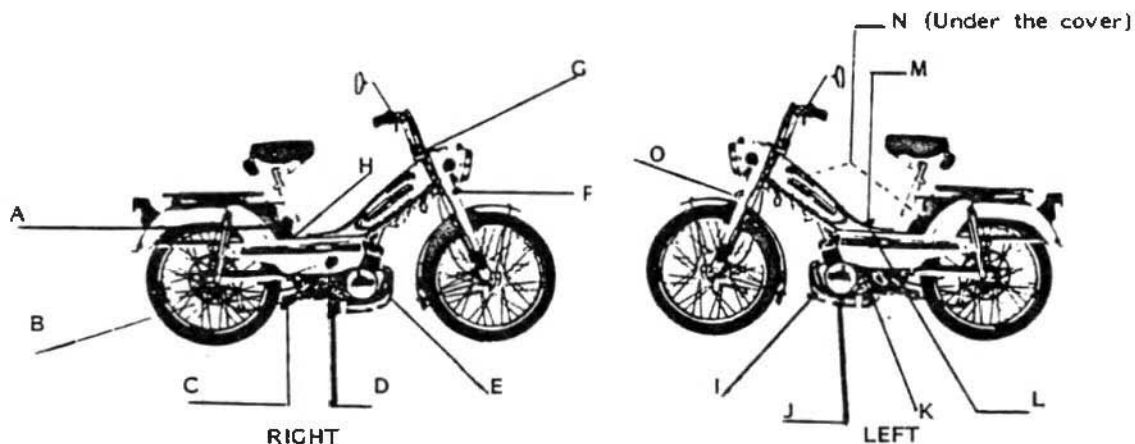

BRAND	FRAME	ENGINE	BRAND	FRAME	ENGINE
Angel	F	L	Motoguzzi	F	D
Baretta	F	J	Motobecane	A, G	E
Batavus	G	G	Odessey	O	I
Bermuda	F	E, I	Pacer	G	E
Blanco	A, G	E	Peugeot	O	E
Bravo	N	D	Puch	H	--
Ciao	N	D	Scout	B	D
Cimatti (L stamped in gold)	O/L	O/L	Sea Gull	O	E
California Sprinter	O	none	Smiley	G	D
Capri	F	J	Soni	G	K
Columbia	F	L	Solex	G	G
Easy Rider	G	--	Speed Bird	O	L
Fantic	A	--	Testi	O	L
Flying Dutchman	O	D	Tomos	A, B	E
Foxi	O	D	Vespa	N	D
Garelli	G	J	Wheel King	O	D
Citane	L	L	Yankee Peddler	H	none
Hercules	O	H			
Intramotor	C	I			
Jawa	F	J			
Kreidler	F	E			
Kynast Electric	F	--			
Lazer	F	L			
Malagutti	G	L			

ACKNOWLEDGEMENT

We wish to express our appreciation to the many motorcycle manufacturers and importers who assisted us in the gathering of information necessary for a book of this kind. With only one exception, we received full cooperation in this project. That exception was Harley-Davidson Motorcycles who claim this information to be "confidential." We regret this decision by Harley-Davidson since the information requested from them is of such nature as to be readily available from public sources. Fortunately, we were able to include Harley-Davidson in this book.

The information contained in this book is as accurate and complete as was possible to obtain from a large number of sources. We can not, however, absolutely guarantee its accuracy and no such warranty is implied.

THE AUTHOR

Lee S. Cole is a private investigator and Consultant specializing in Vehicle Theft, Fraud and Fire cases. He formerly was Assistant Manager of the Pacific Coast Division of the National Automobile Theft Bureau. He attended the University of North Carolina and has since received an LLB degree. During the Korean conflict, Mr. Cole was assigned to the Military Police Corps, Criminal Investigation Division and has worked for the State of North Carolina as an investigator. In 1955, he was appointed Special Agent with the National Automobile Theft Bureau. In January 1964, he was promoted to Chief Special Agent and five years later, was named Assistant Division Manager. Mr. Cole teaches Vehicle Fire and Theft Investigative Techniques at numerous schools and universities throughout the United States and Canada. He was the principal editor of NATB's Passenger Vehicle Identification Manual and is the author of a large number of training bulletins, articles and books on Motor Vehicle Identification, Theft and Fire Investigation.

Lee Books

A Brief History of the Motorcycle

The earliest known version of the motorcycle was the one invented by Gottlieb Daimler of Germany when he fitted his 4 stroke single cylinder engine on his son's bicycle. This success did not really impress Daimler who pursued his inventions in the automobile field.

In the United States, Lucius Copeland placed a one cylinder steam engine on the front wheel of a Star bicycle and produced the first American motorcycle. Between 1895 and 1901, a number of motorcycles were developed and built. The first American motorcycle to be produced in quantity was the "Orient", built in Waltham, Massachusetts by the Waltham Manufacturing Company in 1900.

By 1901, the motorcycle industry in the United States was producing machines with names like "Marsh", "Minneapolis", "Mitchell" and "Indian".

The "Indian" was conceived by a bicycle racer named Oscar Hedstrom who became interested in motorcycles. He formed a company with a bicycle manufacturer named George Hendel and began producing Indian motorcycles. At one time, this company produced 400 Indian motorcycles per day. By the early 1960's, the factory ceased production entirely and the machine now bearing the name "Indian" is built in Taiwan, China.

In 1903, an engineer named Bill Harley and a salesman, Arthur Davidson, formed the Harley-Davidson Company. This well known motorcycle manufacturer has produced a series of the most successful machines in the world. Today, it is the only surviving motorcycle producer in the United States.

During World War II, Soichiro Honda operated a small plant producing piston rings for Japanese military vehicles. Following the surrender of the Japanese, Honda purchased 490 surplus gasoline engines made for the powering communications equipment. He mounted these on bicycles and Honda Motorcycle Company was in business. He began to produce all necessary components and by the early 1960's Honda Motorcycles were being introduced to the United States. The rest, as they say, is history. Honda sells more motorcycles in the United States than all other manufacturers combined.

California, the state with the greatest number of motorcycles, is also the state with the greatest number of motorcycle thefts. In 1970 there were 14,577 such thefts recorded. In 1979 this number had increased to 24,637. Of these, 13,264 were listed as recovered. With the coming of 1980's, all vehicle theft experienced a drop in frequency and in 1983, there were 14,667 motorcycles reported stolen. The recovery percentage was listed at 62.1%. By mid-1984, 6,942 motorcycles were reported as stolen, a drop of 4% from the year before at mid-point.

At the end of 1984, 14,690 motorcycles were reported as stolen with 9,272 listed as recovered. Of these, 7,109 were listed as "driveable" (probably an over optimistic view) and the remaining 2,163 wrecked, stripped and/or burned. The recovery factor was 63.1%. The popularity of theft by model followed almost identically with popularity of sale, with Honda ranked number one followed by Yamaha and Kawasaki.

Motorcycle theft is not only a problem in North America but in European countries as well. A special report filed by Larmtjanst Ab in Sweden reveals that in 1982 the total number of motorcycles registered in that country stood at 139,151. During that same year 2,610 of these machines were stolen. The theft frequency was about 2.3%. Compare this to cars where frequency was about 1%. At least 30% of these stolen motorcycles were not recovered.

Investigation of Motorcycle Thefts

One of the contributing factors to the low recovery rate of stolen motorcycles is the lack of knowledge on the part of law enforcement officers in the location and meanings of identification numbers. Because of the proliferation of makes and models of motorcycles in recent years this is not too surprising. Inconsistencies in the VIN system, especially in the older machines added to the problem.

Another contributing factor is confusion over the proper recording of identifying numbers at the time of original sale and registration. Surveys have shown that in the early 1970's incorrectly registered motorcycles made up 20-55% of the total number of stolen motorcycles, depending upon the particular make. As an example of this problem, suppose we have a Honda CB750 model bearing:

Frame #CB7501044957

Engine #CB750E1045372

We could find this motorcycle registered as 1044957 with the model prefix left off or as CB750E1045372, registered by the engine number. Some motorcycle dealers were only submitting the last five digits for registration.

Some states have taken steps to overcome this situation by requiring tape lifts of engine and frame numbers be submitted with the Dealers Report of Sale. This practice eliminates many errors in registration procedures found in earlier cases. As a rule the motorcycle frame number is that number used for registration and title purposes. One exception to this rule is the 1969 and older Harley-Davidson motorcycle which was registered by the engine number. From 1970 to the present the engine and frame numbers of the Harley-Davidson are the same or the last six digit derivative of the complete VIN (this latter practice began in 1981).

Another contributing factor to motorcycle theft is the ease with which they can be stolen and disassembled. Ignition locks are relatively easy to defeat and sometimes duplicate keys are obtained. Motorcycles are easy to transport in trucks and vans. Stolen motorcycles are sometimes completely stripped and unidentifiable parts sold. Identification numbers on other stolen motorcycles are removed from frames and engines. The Western State Auto Theft Investigation manual published by the Northwest Chapter lists the following common methods for removing these numbers.

1. Factory numbers are stamped into a cast surface. Grinding the numbers will leave a fresh area with sharp surfaces or edges. Sometimes, the file will slip and leave definite markings on studs and cooling fins. Thieves also sometimes grind off the engine numbers and sandblast the number boss to give it a textured appearance.

2. Frame numbers are generally stamped on the fork head or down tube and if ground off will usually leave a flat or oval surface, instead of being round as originally made by the manufacturer.

3. Welding is sometimes used to obliterate factory stampings. On aluminum engines, the heli-arc process is used. On steel frames the arc or oxyacetylene welding is used to obliterate the numbers. Both methods are identifiable by the lack of similarity between the surface of the welded area and the coating or extrusion. Where the difference in surface texture is not apparent, other indications should be noted, such as depressions or holes where welding slag has been deposited. In cases where these methods are suspected, confirmation may be readily made by processing the suspected area with an acid solution or Heinz solution and a cotton swab. The area that has been heli-arc'd or arc welded will readily show up as a darker irregular oval shaped outline even if other number have been re-stamped.

4. Over-stamping the whole number or some digits is very popular and is similar in concept to the cattle rustler who alters brands on stolen cattle. Existing numbers are simply altered by changing a 3 to an 8, a 1 to a 7, or 4, or altering any of the numbers in a similar manner. This often causes numbers altered in this manner to be out of alignment with original digits and the depth to which the number is stamped may vary. Often altered numbers will have a blurred appearance.

The "salvage switch" M/O works as well with motorcycles as it does with cars. The thief purchases a wrecked motorcycle and removes the identification numbers. He then steals a similar machine and places the identity of the wrecked motorcycle on the stolen one.

A common M/O used is to steal a motorcycle, grind off its identifying numbers and then apply to Motor Vehicles registration service for an assigned number, claiming the motorcycle is "home made". Sometimes a left or right case half or a complete frame is purchased, bearing no identifying numbers and placed on a stolen motorcycle.

Frequently, engines and frames are painted or chromed to disguise evidence of alterations. Motorcycle manufacturers do not paint or chrome engines. "Bondo" is frequently used on frames to cover altered, obliterated or drilled out numbers.

Thieves are rarely able to so alter the identification numbers of a motorcycle without leaving some evidence of this. Recognition of such alteration is of primary importance to the vehicle theft investigator. Remember the general rule, "Good numbers look good, bad numbers look bad". Sure, there are going to be cases of very expert alterations but these are in the minority. Most motorcycle thieves are not that skilled.

Be certain that when searching for evidence you give a special attention to locating dies, files, chisels, emery wheels, punches, paint and other equipment used in removing, altering and replacing motorcycle identification numbers. Laboratory analysis can match these items with alteration jobs done on other vehicle in other areas.

Motorcycle Records

The National Automobile Theft Bureau is a non-profit service organization maintained by associated insurance companies for the purpose of assisting law enforcement in suppressing vehicle thefts, identifying vehicles, investigating theft rings, training in identification and investigative techniques and maintaining records to complement these services.

The NATB maintains the following records pertaining to motorcycles:

1. Harley-Davidson Motorcycles
 - A. Engine or VIN from 1958 to present.
 - B. 1958 and 1959 Crankcase Numbers.
not indexed and requires hand search.
 - C. 1960 to present indexed by Crankcase Number.
 - D. 1960 through 1969 Fork Numbers and Transmission Numbers. Not indexed and requires hand search.
 - E. 1970 to present updated monthly on magnetic tape.
 1. Indexed by Crankcase Numbers Fork Numbers and Transmission Numbers.

2. Kawasaki Motors Corporation, U.S.A.
 - A. 1974 to present indexed by Frame Number
 - B. 1974 to present indexed by Engine Number
updated monthly on magnetic tape.

3. American Honda Motor Company
 - A. 1968 to present indexed by Frame Number
 - B. 1970 to present updated monthly on magnetic tape.
 - C. Indexed by Frame and Engine Number.

NATB maintains offices and special agents throughout the United States. There is a similar organization in Canada called the Canadian Automobile Theft Bureau, a branch of the Insurance Crime Prevention Bureau.

NATIONAL AUTOMOBILE THEFT BUREAU DIRECTORY

EXECUTIVE OFFICE

Paul W. Gilliland, President Phone 312-430-2430
10330 South Roberts Road, 3A NLETS-ILNATBC05
Palos Hills, Illinois 60465

NATIONAL SYSTEMS DIVISION:

Rolland R. Smith Manager Phone 312-430-5685
Charles N. Gentry, Asst. Mgr. NLETS-ILNATBC00
10330 South Roberts Road 1B Illinois LEADS-X1A
Palos Hills, Illinois 60465
Territory: This is a service division providing management facilities for the following operational divisions.

EASTERN DIVISION:

Francis P. Haberek, Manager Phone 516-921-0200
Thomas J. Cleary, Asst. Mgr. NLETS-ILNATBC03
750 Woodbury - 3rd Floor East
Woodbury, New York 11797
Territory: Connecticut. Delaware. District of Columbia.
Maine. Maryland. Massachusetts. New Hampshire. New Jersey
New York. Pennsylvania. Rhode Island. Vermont.

BRANCH OFFICE

Kemper Building Phone 617-328-2146
150 Newport Avenue NLETS-ILNATBC07
North Quincy, Massachusetts 02171

WESTERN DIVISION:

Charles E. Gray, Manager Phone 312-430-5100
Michael P. Buchanan, Asst. Mgr. NLETS-ILNATBC01
10330 South Roberts Road, 1A
Palos Hills, Illinois 60465
Territory: Colorado. Illinois. Indiana. Iowa
Kansas. Kentucky. Michigan. Minnesota. Missouri.
Nebraska North Dakota. Ohio. South Dakota. Wisconsin
Wyoming.

BRANCH OFFICE:

Suite 320 Clausen Building Phone 313-424-8414
16000 W. Nine Mile Road NLETS-ILNATBC06
Southfield, Michigan 48075

SOUTHERN DIVISION:

James A. Robertson, Manager Phone 404-3325-3993
Thomas R. Morton, Asst. Mgr. NLETS-ILNATBCII
57 Executive Park Dr., Suite 420
Post Office Box 95008 Georgia GCIC-GANATBA
Atlanta, Georgia 30347
Territory: Alabama. Florida. Georgia. Mississippi.
North Carolina. Tennessee. Virginia. West Virginia.

SOUTHWESTERN DIVISION:

Charley Evans, Manager Phone 214-484-1400
Bryan L. Clark, Asst. Mgr. NLETS-ILNATBCIO
12200 Ford Road, Suite 362 Texas TCIC-DONA
Dallas, Texas 75234
Territory: Arkansas. Louisiana. New Mexico. Oklahoma.
Texas.

BRANCH OFFICE

9000 Southwest Freeway, Phone 713-988-1158
Suite 206 NLETS-ILNATBC12
Houston, Texas 77074

PACIFIC COAST DIVISION

Rex E. Lewellen, Manager Phone 714-522-6450
Gerald D. Boyer, Asst. Mgr. 213-860-0684
10820 E. 183rd St. Suite 210 NLETS-ILNATBC08
Cerritos, Ca. 90701
Territory: Alaska. Arizona. California. Hawaii.
Idaho. Montana. Nevada. Oregon. Utah. Washington.

BRANCH OFFICE

333 Serramonte Plaza Phone 415-756-1576
Daly City, California 94015 NLETS-ILNATBC09

CANADIAN AUTOMOBILE THEFT BUREAU

A Branch of Insurance Crime Prevention Bureau
Jean-Claude Cloutier, FIIC General Manager
E. M. Swift, Assistant Manager - Operations
Toronto, Ontario

ADDRESS ALL FIELD INQUIRIES TO:

Ontario
D.M. Graham, Superintendent Phone 416-252-5215
R.D. Overton, Chief Special Agent Telex: 06-967579
P.O. Box 191, Stn. "U"
Toronto, Ontario M8Z 5P9 Canada

QUEBEC PROVINCE

G.J. Migeault, Manager
P. Casey, Chief Special Agent
P.O. Box 488, Stn. B
Montreal, Quebec N3B 3K3 Canada

Phone 514-288-4103
Telex: 05-24166

ATLANTIC PROVINCES

New Brunswick & Prince Edward Island

C.A. Roy, Chief Special Agent

Phone 56-85-5935

A.G. Michaud, Special Agent

P.O. Box 314

Moncton, N. B. EIC 8L4 Canada

NOVA SCOTIA

G.A. Chisholm, Special Agent

Phone 902-422-1260

P.O. Box 3021, Halifax

South Postal Stn.

Halifax, N. S. B3J 3G3 Canada

NEW FOUNDLAND

J.L. Power, Special Agent

Phone 709-722-3104

P.O. Box 4531

Harvey Rd. Post Office

St. John's Nfld. A1C 6C8 Canada

ALBERTA

E.W. J. Mitchell, Special Agent

P.O. Box 8459, Stn. "F"

Edmonton, Alberta 76H 5H3 Canada

VIN SYSTEMS

Prior to 1980 each manufacturer adopted and put in use their own method of identifying their product. Some of these systems were all numeric, some were alpha and numeric. Some series identified the engine alone with no numbers assigned to the frame. Some systems consisted of 12 characters while some had only 4.

It was obvious that a more uniform approach to the problem was needed and by 1981 a new system was developed after numerous conferences and experimentation. While there are some problems still existing, this move toward standardization of the VIN was most welcome. With very few exceptions it has been adopted. Off road machines are not required to comply with 17 digit VIN.

The VIN system in use today is described as a "17 character VIN rigid as to content and position and including a 'check' digit". This system is illustrated by the following example:

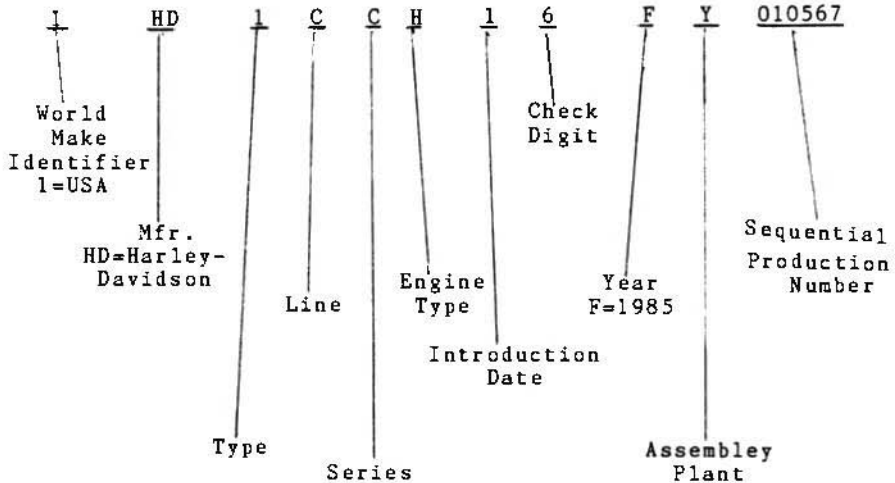

The method of arriving at the "Check Digit" is illustrated by the following:

Motor vehicles now have a 17 character VIN with a "Check Digit" included. The first three characters identify the nation of origin, manufacturer, make and type of vehicle. The second section consists of five characters and identifies the "vehicle attributes" (type, line, engine type, series, etc.). The ninth character is the "Check Digit" and is intended to verify the accuracy of the VIN as to the sequence and format. The third part of the VIN is eight characters in length and identifies the model year, plant and sequential production number. The following table will enable you to decode the VIN's "Check Digit".

	1	2	3	4	5	6	7	8	9	10	11	12	13	14	15	16	17
A																	
B																	
C	8	7	6	5	4	3	2	10	0	9	8	7	6	5	4	3	2
D																	

final
sum

11 | _____

On line "A" enter the 17 digit VIN. On line "B" enter the "assigned value" of each character of the VIN, utilizing table "B", shown below. * Multiply the numbers in line "B" with the numbers in line "C", for each of the 17 digits in the VIN. Record the product of each of these separate computations in the appropriate boxes in line "D". * Add together all of the numbers recorded in line "D" and enter the final sum in the space provided. * Divide the final sum by the number "11". The remainder of this division is the "Check Digit" (the 9th character of the 17 digit VIN.) If the remainder of this division is a single digit number, then it should match the "Check Digit" in the VIN exactly. If the remainder is the number "10" then the "Check Digit" is the letter "X".

TABLE "B"

A=1	J=1	T=3	1=1	6=6	Assign to each number in the VIN its actual value and record that value in the appropriate box "B".
B=2	K=2	U=4	2=2	7=7	
C=3	L=3	V=5	3=3	8=8	
D=4	M=4	W=6	4=4	9=9	
E=5	N=5	X=7	5=5	0=0	
F=6	P=7	Y=8			The letters of "I", "O", & "Q" are never used in the new 17 digit VINs.
G=7	R=9	Z=9			
H=8	S=2				

To determine the year of manufacture from the 17 digit VIN (character #10 of the VIN), use the following:

1980=A	1982=C	1984=E	1986=G	
1981=B	1983=D	1985=F	1987=H	Etc.

EXAMPLE: 1981 Ford Mustand VIN - 1FABP12A4BR101093

Final Sum = 246

$$\begin{array}{r}
 11 \overline{) 246} \\
 \underline{22} \\
 26 \\
 \underline{22} \\
 4
 \end{array}$$

Check Digit-----4

EXPLANATION OF THE WMI

("World Manufacturer Identifier" or "Nation of Origin")

The WMI is the first three digits of a 17 digit VIN. The first two digits are allocated by the International Standards Organization and a record of these is maintained by the Society of Automotive Engineers, Inc. of 400 Commonwealth Drive, Warrendale, Pennsylvania 15096, United State of America. The third digit is allocated by a country's representative body. For the United Kingdom, it is the British Standards Institute, Maylands Avenue, Hemel Hempstead, Herts.

Below are details of the numbers and letters allocated, together with the recipient country.

1st D	2nd Digit	Country	Continent
A	A to H	South Africa	Africa
A	J to M	Ivory Coast	Africa
B	A to F	Angola	" B B
B	G to K (except I)	Kenya	"
B	L to R (except Q)	Tanzania	"
C	F to K	Dahomey	"
C	F to K (except I)	Malagasy	"
C	L to R (except Q)	Tunisia	"
D	A to E	Egypt	"
D	F to K (except I)	Morocco	"
D	L to R (except Q)	Zambia	"
E	A to E	Ethiopia	"
E	F to K	Mozambique	"
F	A to E	Ghana	"
F	F to K (except I)	Nigeria	"
G	A to E	Madagascar	"
J	A to Z & 1 to 9 (except I & Q)	Japan	Asia
K	A to E	Ceylon	"
K	F to K (except I)	Israel	"
K	L to R (except Q)	South Korea	"
L	A to R	China	"
M	A to E	India	"
M	F to K (except I)	Indonesia	"
M	L to R (except Q)	Thailand	"
N	A to E	Iran	"
N	F to K (except I)	Pakistan	"
N	L to R (except Q)	Turkey	"
P	A to E	Philippines	"
P	F to K (except I)	Singapore	"
S	A to M (except I)	United Kingdom	Europe
S	A to M (except I)	East Germany	"
S	U to Y	Poland	"
T	A to H	Switzerland	"
T	J to N	Czechoslovakia	"
T	P to V (except Q)	Hungary	"
T	W to Z	Portugal	"
U	H to N (except I)	Denmark	"

1st Digit	2nd Digit	Country	Continent
U	P to T (except Q)	Ireland	Europe
U	U to Y	Romania	"
V	A to E	Austria	"
V	S to W	Spain	"
V	X to Z	Yugoslavia	"
V	F to K (except I)	France	"
W	A to Z & 1 to 0	West Germany	"
X	A to E	Bulgaria	"
X	F to K (except I)	Greece	"
X	L to R (except Q)	Netherlands	"
X	S to W	U.S.S.R.	"
Y	A to E	Belgium	"
Y	F to K (except I)	Finland	"
Y	L to R (except Q)	Malta	"
Y	S to W	Sweden	"
Z	A to L (except I)	Italy	"
1	A to Z & 1 to 9	United States	No.America
2	A to W (except I&Q)	Canada	"
3	A to W (except I&Q)	Mexico	"
3	X to Z	Costa Rica	"
3	3 to 7	Trinidad	"
6	A to W (except I&Q)	Australia	"
7	A to E	New Zealand	Oceania
8	A to E	Argentina	So.America
8	F to K (except I)	Chile	"
8	L to R (except Q)	Ecuador	"
8	S to W	Peru	"
8	X to Z	Venezuela	"
9	A to E	Brazil	"
9	F to K (except I)	Columbia	"
9	L to R (except Q)	Paraguay	"
9	S to W	Uruguay	"

AJS

AJS of Andover, Goodworth, Claysford. Hants., England

VIN - Stamped into left side of headstock.

Engine Number - Stamped into left side of crank case under cylinder barrel.

The frame and engine numbers are the same and consist of 5 numbers and possibly a letter at the end.

VIN SYSTEM

75
/
Year

123
/
Sequential
Number

E
/
Model

E = Enduro
T = Trail/Trial
S = Scrambler
SS = Scrambler with single
rear shock absorber

They make the following models:

Scrambler
250cc
360cc
410cc
490cc

Trials/Trails
250cc
260cc

ARIEL

VIN SYSTEM: (No example available. No longer in production.)

VIN on plate and stamped into left side of headstock.

Engine Number - Stamped into left side of crankcase under cylinder barrel.

BMW

Bayerische Motoren Werke
(BMW Motorrad GMBH, Munich, West Germany)

VIN SYSTEM: 1985 - 1981

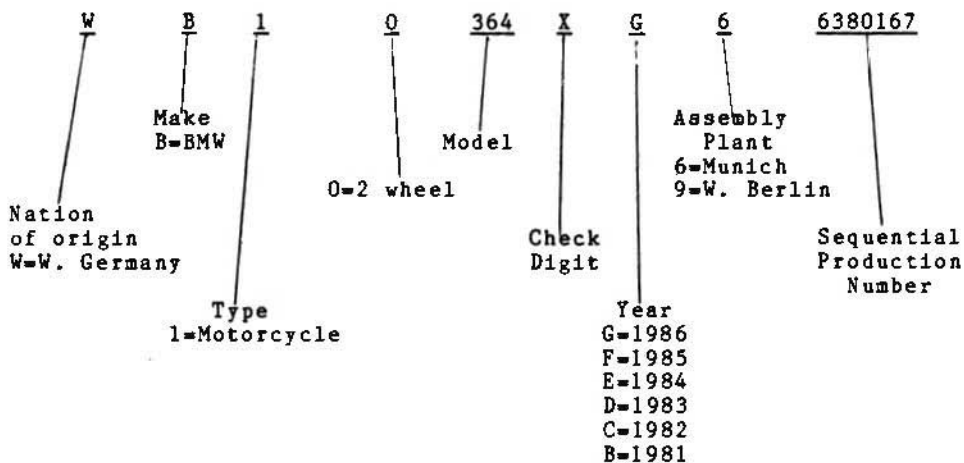

VIN Location - The complete 17 digit VIN is recorded on the Federal Certification label located on the right side of the frame below the right engine cylinder. A derivative of this number is stamped into the down tube brace below headstock on right side. Frame numbers are protected by inclusive trademark symbols. The number includes the plant designator and sequential number.

Engine Number - Same as frame number. Located on right side below cylinder, near oil dip stick.

Models: R65 = 3640 (650cc)
 R65LS = 3650 (650cc)
 R80G/S = 3480 (798cc)
 R80ST = 3490 (798cc)
 R80RT = 4480 (798cc)
 R100 = 4350 (980cc)
 R100CS = 4360 (980cc)
 R100RS = 4370 (980cc)
 R100RT = 4490 (980cc)

Pre 1981 Models

VIN SYSTEM: 4001044

All numeric with no year or plant indicators.

VIN Location - Frame number on right side or in front of headstock, either stamped or on a thin piece of metal plate riveted to frame.

Engine Number - Same as frame number. Located on either right or left side of crankcase or engine housing depending on model.

Models-

R 50/2	=	500cc	R 100/7	=	1000cc
R 60/2	=	600cc	R 100 S	=	1000cc
R 65/7	=	650cc	R 100 RS	=	1000cc
R 69/2	=	700cc	R 100 RT	=	1000cc
R 69/S	=	700cc			
R 75/5,6,7	=	7-750cc			
R 80/7	=	800cc			

	<u>Year</u>	<u>Model</u>	<u>Engine & Frame Number</u>
250 cc Singles	1949	R24	200 009 - 212 007
	1950-51	R25	220 001 - 243 400
	1951-53	R25/3	245 001 - 283 650
	1954	R25/3	284 001 - 331 705
	1955-61	R26	340 001 -
	1961-67	R27	372 001 - 387 566
500cc Twins	1950	R51/2	516 001 - 521 005
	1951	R51/3	522 001 - 526 209
	1952-53	R51/3	526 210 - 536 000
	1954	R51/3	536 001 - 540 950
	1955-61	RR50	550 001 - 563 515
	1961-69	R50/2,-US	630 001 - 649 037
	1960-61	R50S	564 001 - 565 634

	<u>Year</u>	<u>Model</u>	<u>Engine & Frame Number</u>
600cc Twins	1951	R67	610 001 - 611 449
	1952-53	R67/2	612 001 - 616 226
	1954	R67/3	616 227 - 617 700
	1956-61	R60	618 001 - 621 530
	1961-69	R60/2	622 001 - 629 999
		R60US,-/2	1 810 001 - 1 819 307
600cc Sport Twins	1952-54	R68	650 001 - 651 453
	1955-61	R69	652 001 - 654 955
	1961-69	R69S,-US	655 004 - 666 320
Type 246:			
500cc Twin	1970	R50/5	2 900 001
600cc Twin	1970	R60/5	2 930 001
750cc Twin	1970	R75/5	2 970 001

BSA

(Birmingham Small Arms Corporation)
Birmingham, England
(Production ceased August, 1974)

VIN SYSTEM: (1969-1974)

<u>E</u>	<u>K</u>	<u>00677</u>	<u>A75R</u>
Month of Mfr.	Year	Sequential Production Number	Model Designator

VIN SYSTEM: (Prior to 1969)

<u>A75R</u>	<u>00677</u>
Model Designator	Sequential Production Number

DATE OF MANUFACTURE: (1969-1974 VIN)

1st LETTER

A - January
B - February
C - March
D - April
E - May
G - June
H - July
J - August
K - September
N - October
P - November
X - December

2nd LETTER

C - indicates 1969 model
D - indicates 1970 model
E - indicates 1971 model
G - indicates 1972 model
H - indicates 1973 model
J - indicated 1974 model

To avoid confusion, the letters F, I, O and L have not been used.

VIN LOCATION - On 1965 and earlier models, frame number located near front of gas tank. On 1966 and later models, frame number stamped lower on frame, almost directly in front of engine number.

Engine Number - On left side of crankcase below cylinder.

1. Starting in June, 1966, the frame and engine numbers should match; however, exceptions have been noted.
2. Starting in 1969, a BSA logo appears on the engine boss with the exception of the single cylinder and smaller models.
3. The engine and frame numbers are hand stamped and generally uneven, although the model designator is usually even and a "jig" is normally used to stamp these.
4. The engine number is stamped directly on a sand casted metal raised flat boss; never on a smooth surface.
5. There are many inconsistencies in VIN registration and computer entries due to recent changes in VIN code and dealer confusion. The model number is sometimes entered as a prefix instead of a suffix on 1969 and later models.

Models:

B50SS	-	Goldstar	A75R	-	Rocket
B50	-	Victor Trail	B500MX	-	Victor
B50MX	-	Victor MX	B50MX	-	Sceptre (1974)
A65T	-	Thunderbolt	A50R	-	Royal Star
A65L	-	Lightning	A65F	-	Firebird Scrambler

BENELLI

Benelli Motorcycles, Pesaro, Italy
Imported by Cosmopolitan Motors
301 Jacksonville Road
Hatboro, PA 19040

VIN SYSTEM:

66846

The VIN has no particular significance in its configuration. The die stamps used by the manufacturer are not unique.

VIN Location -

On current models, this number is stamped on the right side of the headstock, and on a plate attached to the down tube. The numbers are protected by a five point star before and after the number. On older models, the frame number was sometimes located on an engine mounting plate on top of either side of the crankcase near the engine number.

Engine Number -

Located on the top or lower side of either crankcase. The numbers are stamped into a raised boss and are not protected by the stars as is the frame number. The engine and frame numbers usually match, but are not always the same.

Models

Range from a 65cc Dynamo Trail bike to the 750cc SEI model with 6 cylinders

BRIDGESTONE

Bridgestone Motorcycle, Tokyo, Japan
(Discontinued - 1976)

VIN SYSTEMS:

No example available.

VIN Location -

Right side of frame, bottom near suspension
swing pivot, on plate.

Engine Number -

At rear of crankcase, right side or near kick
started shaft.

Models -

100 G/P	-	100cc
100 TMI	-	100cc
M11 RS-1	-	200cc
M11 SS-1	-	200cc
350 GTR-1	-	350cc
350 GTO-1	-	350cc

BULTACO

Compania Espanola De Motores SA, Barcelona, Spain

VIN SYSTEM:

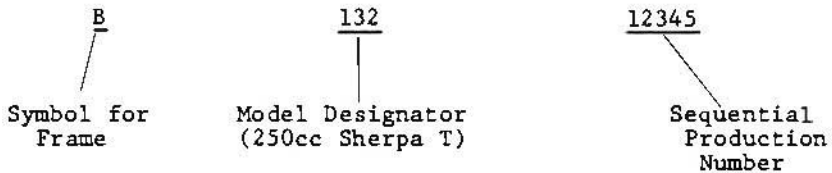

VIN Location - Stamped into headstock, right side. The dies are not unique and the number is not protected with any distinctive marks.

Engine Number - Located on top of right side of engine crankcase behind cylinder head. This number is the same as the frame number, except for the prefix "M". This letter is preceded by another letter indicating the cubic capacity of the engine.

Z..... 50cc	L.....300cc
Y..... 75cc	K.....325cc
X.....100cc	J.....350cc
V.....125cc	H.....360cc
U.....150cc	G.....400cc
T.....175cc	F.....425cc
S.....200cc	E.....450cc
R.....225cc	D.....475cc
P.....250cc	C.....500cc
N.....275cc	

BULTACO MODEL NUMBERS

Model
Designators

1
2
3
4

Model

Common to all models
Common to all models
4-Speed Sherpa S
200cc 4-Speed Matador

Model Numbers Cont'd

<u>Model Designators</u>	<u>Model</u>
6	Aircooled T.S.S.
7	175cc Blue Mercurio
8	200cc Metralla
10	4-Speed Sherpa T
11	250cc 4-Speed Metisse
13	175cc Red Mercurio
14	125cc T.S.S. Watercooled
16	4-Speed Matador MK 11
17	350cc Bandido
18	360cc Bandido
19	100cc Lobito Trail 4-Speed
20	100cc Lobito Trail 4-Speed
21	175cc Campera 4-Speed
23	250cc Metralla, IT-23 denotes El Tigre 250cc
24	250cc T.S.S. Watercooled
26	250cc Matador 5-Speed 111
27	250cc Sherpa T 5-Speed
28	175cc Campera 5-Speed MK11
29	350cc T.S.S. Aircooled
30	100cc Sherpa S
34	200cc Mercurio
35	200cc Mercurio, IT-35 denotes El Tigre 200cc
36	175cc Campera 4-Speed
38	100cc Lobito "K"
40	125cc T.S.S. Watercooled
41	250cc T.S.S. Watercooled
42	250cc Pursang MK11
43	125cc 5-Speed Sherpa S
44	175cc 5-Speed Sherpa S
45	200cc 5-Speed Sherpa S
48	250cc Pursang MK111
49	250cc 5-Speed Sherpa T
50	350cc Bandido
51	360cc Montadera
54	100cc 5-Speed Lobito Trail MK111
61	360cc Bandido II
62	125cc Lobito Trail MK111
63	125cc Sherpa S
66	175cc Sherpa S

Model Numbers Cont'd

Model Designators

Model

67	200cc Sherpa S
68	250cc Pursang MK 1V "A" + "E"
70	360cc Montadero MK11
73	100cc Tiron Mini Bike
74	125cc Lobito MK1V
75	250cc Matador MKIV
76	175cc Lobito MKIV
80	250cc Sherpa T - "Campeon"
81	360cc Montadero MK 11
82	250cc Matador "SD"
83	125cc Lobito MK V
84	175cc Lobito MK V
85	250cc Alpina
86	250cc Pursang MK V "E"
87	350cc Pursang "E"
89	125cc Pursang MK V
90	250cc Pursang "Astro"
92	350cc Sherpa T
105	250cc Pursang Astro
106	350cc Pursang Astro
107	Matador SD MK V
108	74cc Brinco
110	250cc Kart (Europa)
111	49cc Chispa
115	250cc Alpina
116	350cc Alpina
117	125cc Pursang MK V11
118	175cc Pursang MK V11
119	200cc Pursang MK V11 (Europa)
120	250cc Pursang MK V11
121	360cc Pursang MK V11
123	360cc Astro
124	250cc Sherpa T
125	350cc Sherpa T
126	74cc Lobito
127	125cc Lobito
128	175cc Lobito
130	74cc Junior
132	250cc Sherpa T
133	350cc Sherpa T
134	200cc Pursang MK V111
135	250cc Pursang MK V111
136	360cc Pursang MK V111

Model Numbers Cont'd

Model Designators

137
138
139
140
142
143
144
145
146
147
148
149
150
151
152
155
156
158
159
162
163
164
165
166
167
168
170

Model

250cc Alpina
350cc Alpina
155cc Mercurio GT
350cc Matador MK 9
250cc Metralla GT
363cc Frontera
125cc Pursang MK VII
250cc Astro
360cc Astro
74cc Lobito
125cc Lobito
175cc Lobito
250cc Sherpa T
350cc Sherpa T
250cc Frontera
74cc Lobito T
125cc Sherpa T
250cc Sherpa T
350cc Sherpa T
125cc Pursang
250cc Astro
360cc Astro
250cc Alpina
350cc Alpina
250cc Pursang
370cc Pursang
200cc Pursang

CAGIVA

Manufactured in Italy, (Imported into USA by Cagiva of North America, Inc., 20030 South Normandie Avenue, Torrance Ca. 90502)

VIN SYSTEM:

ZCGBBDFGOFV123456

Elefant 659 - Street Machine

ZCGACDFF2FV123456

Alazzara 650 - Street Machine

ZCGCBYHX3FV123456

WMX 500/85 - Motocross 500cc

ZCGCBXAX4FV123456

WMX 124/85 - Motocross 125CC

VIN Location - On right side of headstock.

Engine No. - No location available, check both sides of case, top and bottom.

CAN - AM

Can Am Motorcycles, Valcourt, Quebec, Canada
Imported into US by Bombardier Corporation
P.O. Box 61106, Duluth, MN 55806
P.O. Box 1569, Idaho Falls, ID 83403

VIN SYSTEM:

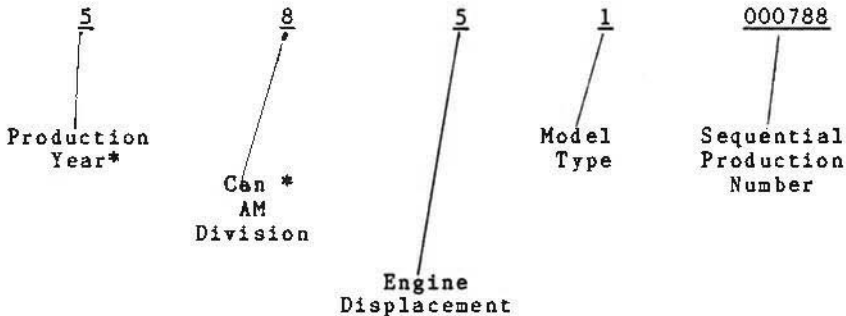

* From 1979 production on the position of these digits was reversed.

Engine Displacement
(3rd digit)

- 1 Up to 50cc
- 2 51 to 80cc
- 3 81 to 100cc
- 4 101 to 125cc
- 5 126 to 200cc
- 6 201 to 250cc
- 7 251 to 350cc
- 8 351 to 500cc
- 9 501 to 750cc
- 0 . 751 to 1000 open

MODEL TYPE
(4th digit)

- 1 Enduro (T'NT)
- 2 Touring
- 3 .. Motocross (MS-1)
- 4 Road Race
- 5 Trials
- 6 .. T.T.Short Track
- 7 Speedway
- 8 Trail
- 9 Mini-Midi
- 0 Open

CAN-AM PRODUCTION SERIES

<u>YEAR</u>	<u>DESCRIPTION</u>	<u>MODEL NO.</u>
1976	175 "OR" TNT	6855
1977	125 Qualifier	7845
	175 Qualifier	7855
	250 Qualifier	7865
	175 TNT	7851
	250 TNT	7861
	175 MX-3	7854
	250 MX-3	7864
1978	125 "S"	8844
	125 MX-4	8840
	250 MX-4	8864
	370 MX-4	8884
1979	175 Qualifier	8955
	250 Qualifier	8965
	370 Qualifier	8985
	250 MX-5	8964
	370 MX-5	8984

1985 CAN-AMS

1983/1984 CAN-AMS

<u>Model</u>	<u>Description</u>	<u>MODEL</u>	<u>DESCRIPTION</u>
8416	125 MX LC	8413	250 MX LC
8417	250 MX LC	8414	500 MX
8418	500 MX	8415	560 Sonic MX
8419	560 Sonic MX	8521	175 ASE
8528	200 ASE	8522	250 ASE
8529	250 ASE	8524	320 Trials
8530	250 ASE LC	8409	250 MX LC
8527	500 ASE	8410	500 MX
8531	240 Trials	8411	Sonic MC
8532	350 Trials		

VIN Location - Stamped on steering head, left side.

Engine Number - Stamped on bottom of crankcase. Engine displacement is stamped on left side of cylinder between 2 bottom cooling fins. Engine number may also be found on right side of rear mount boss.

CAPRIOLA

(No Longer in Production)

VIN SYSTEM: 39972

Vin Location - Middle of left side of frame near crankcase.

Engine Number - 39716

Engine Number Location - On lower left side of crankcase.

DUCATI

Ducati Meccanica, Bologna, Italy

VIN SYSTEM:

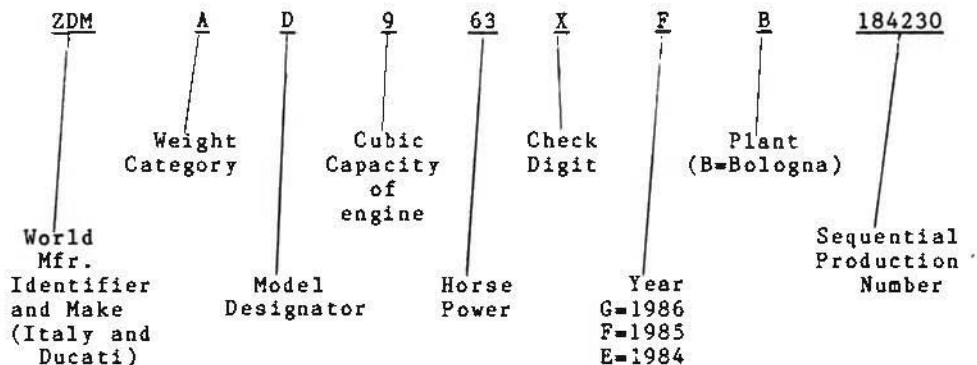

Model Designators:
P = 500 Pantah
D = 900 Supersport

Cubic Capacity of Engine
5 = 500cc
6 = 600cc
9 = 900cc

- VIN Location - Stamped into plate riveted to headstock with sequential portion stamped into frame nearby.
- Engine Number - Stamped into engine, rear center, at top. Same as frame number.
- Older Models - Locations same as above. Typical VIN: 482-0-3427

FANTIC

(No Longer in Production)

VIN SYSTEM: No example available.

VIN Location - Stamped into frame where tank and saddle join.

Engine Number - On plate attached to top side crankcase to rear of cylinder.

Models Produced:

RC Caballero	125cc	Road/Trail
Chopper	125cc	Road/Street

GREEVES

Greeves Motorcycles, Thundersley, England
(Production discontinued - 1976)

- VIN SYSTEM: No example available.
- VIN Location - On left side of headstock.
- Engine Number - On Woods models located on top of left hand
primary case. On Moto models on right crankcase
at cylinder base.

GUAZZONE

(No longer in Production)

VIN SYSTEM: 05124

Vin Location - On down tube of frame near front engine
mount.

Engine Number - Same as VIN (Frame Number)

Engine Number Location - On front engine mount at junction with
down tube.

HARLEY-DAVIDSON

Harley-Davidson Motor Co., Milwaukee, WI

According to R.L. Polk Company, Detroit, during the first quarter of 1985 Harley-Davidson Motorcycles comprised 3.64% of new registrations. In 1985 there were 1,369 unrecovered Harley-Davidson in California.

VIN SYSTEM: 1981 - 1986

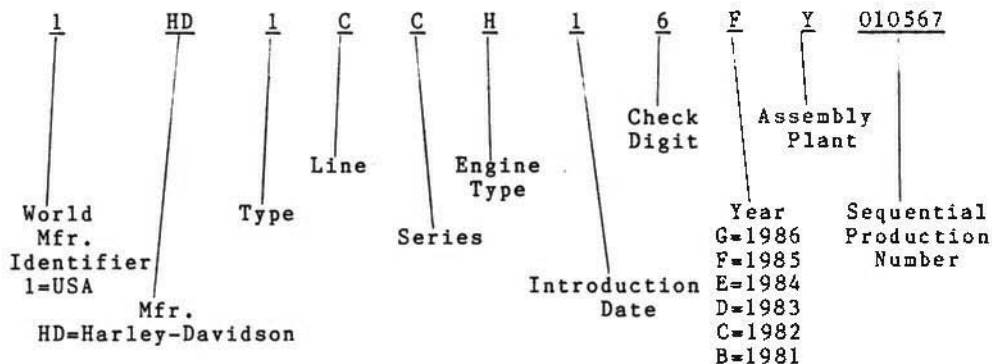

TYPE

- 1 = Heavyweight (901cc and up)
- 4 = Middleweight (351 - 900cc)
- 6 = Lightweight (350cc and under)

LINE

- A = FL
- B = FX
- C = XL
- D = FLT
- E = FXR
- S = Sidecar

SERIES

<u>Line "A"</u>	<u>Line "D"</u>
A = FLH -	A = FLT
B = FLH - Police	B = FLT - Classic
C = FLH - Shrine	C = FLT - Police
D = FLH - Classic	D = FLT - Shrine
E = FLT - (1981)	
F = FLH - Classic (1981)	
G = FLH - Classic and Sidecar	
H = FLH - Police DLXE	
L = FLH - 80-Heritage	
K = FLHS -Sport	

Line "E"

A = FXR - 80
B = FXRS- 80

Line "B"

A = FXE
B = FXEF- 80
C = FXS - 80
D = FXB - 80
E = FXWG- 80

Line "S"

B = TLE
C = LTLE- Classic
D = CLE - (W/FLH Classic)
E = CLE - (Ordered alone)
F = CTLE- (Ordered c/cycle)
G = CTLE- (Ordered alone)

Line "C"

A = XLH
B = XLS

ENGINE TYPE

H = 4 Cycle V-2 55 HP
J = 4 Cycle V-2 60 HP
K = 4 Cycle V-2 64 HP

INTRODUCTION DATE

1 = Regular Introductory Date
2 = Mid-year

ASSEMBLY PLANT

Y = York, PA
T = Tomahawk, WI
J = Milwaukee, WI

VIN Location - Complete 17 digit VIN is stamped into the headstock on the right side with the exception of the FLT model which is on the left side. In 1982, Harley-Davidson discontinued stamping protective stars at the beginning and end of VIN. The complete 17 digit VIN is repeated on the Federal certification label affixed to the down tube on the right side.

Engine Number - Stamped on the right side of case to right of front cylinder. Beginning in December, 1982 all 140cc engines have number stamped on left side below cylinders. Engine number is a derivative of the VIN.

EXAMPLE:

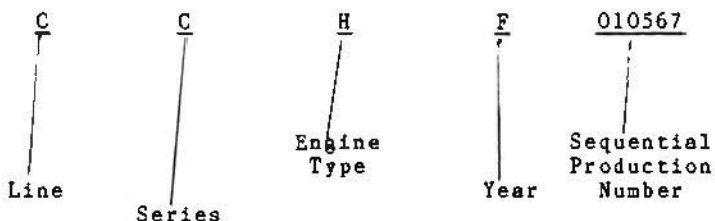

Supplemental Numbers:

Beginning in 1961 all Harley-Davidson motorcycles of 1000cc and larger were stamped with the following supplemental numbers.

1. Frame number on left side of headstock (until 1969)
2. Fork stop number on triple clamp
3. Transmission number on right front face of case

Records searches on all of the numbers should be referred to the National Automobile Theft Bureau.

VIN SYSTEM - 1970-1980 AND ENGINE AND FRAME NUMBER LOCATIONS -

In 1970, Harley-Davidson changed their identification system in an effort to obtain uniformity. On 1970 models engine numbers are located on the right half of the crankcase near the front. Early engines were still manufactured with the boss on the left side left blank. On occasions, thieves will stamp fictitious numbers on this boss which often appear genuine. In 1970, Harley-Davidson began stamping frame numbers the same as the engine numbers. The frame number is located on the right side of the frame head or headstock, on a raised boss. Both the frame and engine numbers were preceded and followed by a star.

Example: *1A1000HO*

If the frame or engine number requires correction, the number originally stamped will not be removed. The original number will be lined out at the factory. The new number or correct number will be stamped immediately above or below the incorrect number.

Example:

~~*1A 10000H0*~~

1A 10000H0

In addition, Harley-Davidson began using a distinctive series of letter and number stamps called "Posident Characters".

0 1 1 2 3 4 5 6 6 7 8 9 9

Following is a list of model prefixes and the associated model for some crankcase number:

<u>Case Prefix</u>	<u>Associated Model</u>
1	61 cubic inch E or EL model and 74 cubic inch FL and FLH models.
2	125 cubic inch S model and 165 cubic inch ST and STU models.
3	45 cubic inch W, WL, WLD, G and GA models.
4	75 cubic inch and 80 cubic inch V, UL, VH, and UHL models.
5	45 cubic inch and 55 cubic inch K, KRM, KH, KHK and KHRM models.
6	125 cubic inch B model.
7	55 cubic inch "Sportster" XL, XLH, XLC and LCH models.

In 1979, between the dates of January 1 and February 6, the crankcase code was stamped on the engine in the location for the engine number. This oversight was corrected on February 7, 1979. The motorcycles affected by this ran from VIN ..43000H9 to ..48199H9.

HARLEY MODELS - 1970-1980

<u>CODE</u>	<u>MODEL</u>	<u>VEHICLE MODEL NAME</u>
1A	FL-1200	Electra Glide
2A	FLH-1200	Electra Glide
3A	XLH-1000	Sportster
4A	XLCH-1000	Sportster
5A	GE-750	Servi-Car
6A	SS-350	Sprint SS-350
7A	SX-125	Rapido
8A	M65	Leggero
9A	J	

Harley Models Cont'd

<u>CODE</u>	<u>MODEL</u>	<u>VEHICLE MODEL NAME</u>
1B	Y-398 &Y-400	Snowmobile
2B	O	Personnel Carrier
3B	D	Golf Car
4B	DE	Golf Car
5B	DC	Utilicar
6B	DEC	Utilicar
7B	ERS	Sprint Scrambler
8B	MSR100	Baja
9B	XLRTT	TT Racer
1C	XR-750	XR-750
2C	FX-1200	Super Glide
3C	SX-350	Sprint Enduro
4C	CR	P.O. Engines/Shorttracker
5C	MC-65 Minicycle	Shortster
6C	MSR100L	Baja (was 8B)
7C	D4	Golf Car
8C	DE4	Golf Car
9C	Y440	Snowmobile
1D	LE	Sidecar
2D	X-90 (MC-90)	X-90
3D	Z-90 (M-90)	Leggero (was 8A)
4D	XLA	Army only
5D	SX-175	SX-175
6D	SX-250	SX-250
7D	MX-250	MX-250
8D	DE40	Golf Car
9D	FXE-1200	Super Glide
1E	YE-398	Snowmobile
2E	YE-440	Snowmobile
3E	SST-125	SST-125
4E	XLS	Roadster
5E	FXEF-1200	Super Glide
6E	FXEF-80	Super Glide
7E	FLHS	Electra Glide
8E	GE-1200	Servi-Car
9E	SS-250	SS-250

Harley Models Cont'd

<u>CODE</u>	<u>MODEL</u>	<u>VEHICLE MODEL NAME</u>
1F	RR-250	Road Racer
2F	FXS-1200	Low Rider
3F	SXT-125	SXT-125
4F	SS-175	SS-175
5F	RR-500	RR-500
6F	SS-125	SS-125
7F	XLCR-1000	Cafe Racer
8F	SST-350	SST-350
9F	SX-350	SX-350
1G	MX-360	
2G	XLT-1000	XLT Touring
3G	FLH-80	Electra Glide
4G	RX-250	RX-250
5G	FLT	Tour Glide
6G	FXE-80	Super Glide
7G	FXS-80	Super Glide
8G	XLP	Police Sportster
9G	FXWG	Wide Glide
1H	FXB	Sturgis
2H	CLE	Classic Sidecar

Begin VIN

End VIN

1970

1A 10001 HO
 2A 10003 HO
 3A 10008 HO
 4A 10002 HO

1A 26609 HO
 2A 26625 HO
 3A 26796 HO
 4A 35553 HO

1971

1A 10001 H1
 2A 10005 H1
 2C 10004 H1
 4A 10007 h1

1A 33610 H1
 2A 34379 H1
 2C 33528 H1
 4A 33384 H1

VIN Cont'd

<u>Begin VIN</u>	<u>End VIN</u>
<u>1972</u>	
1A 10108 H2	1A 42294 H2
2A 10001 H2	2A 42296 H2
2C 10002 H2	2C 42278 H2
3A 10004 H2	3A 52540 H2
4A 10059 H2	4A 52487 H2
<u>1973</u>	
1A 11791 H3	1A 23410 H3
2A 10003 H3	2A 71933 H3
2C 10000 H3	2C 71927 H3
3A 40001 H3	3A 71876 H3
4A 40002 H3	4A 71774 H3
<u>1974</u>	
1A 16605 H4	1A 47381 H4
2A 10015 H4	2A 47388 H4
2C 10010 H4	2C 47393 H4
9D 10006 H4	9D 47392 H4
3A 10000 H4	3A 47344 H4
<u>1975</u>	
1A 13800 H5	1A H5
2A 10000 H5	2A H5
2C 10002 H5	2C H5
9D 10001 H5	9D H5
3A 10004 H5	3A H5
<u>1976</u>	
1A 21323 H6	1A 53953 H6
2A 10001 H6	2A 55360 H6
2C 10003 H6	2C 53525 H6
3A 10005 H6	3A 55308 H6
4A 10000 H6	4A 55291 H6
9D 10002 H6	9D 55388 H6

Begin VINEnd VIN1977

1A 10011 H7
 2A 10001 H7
 2C 10114 H7
 2F 00277 H7
 Only One of
 2G 19844 H7
 3A 10000 H7
 4A 10006 H7
 7E 00142 H7
 7F 00001 H7
 9D 10230 H7

1A 53887 H7
 2A 55191 H7
 2C 65487 H7
 2F 15631 H7
 2F 72270 H7
 2G 51061 H7
 3A 53775 H7
 4A 51552 H7
 7E 52036 H7
 7F 42896 H7
 9D 67556 H7

1978

1A 18625 H8
 2A 10001 H8
 2C 10002 H8
 2F 10004 H8
 3A 10000 H8
 3G 10878 H8
 4A 10006 H8
 7F 00276 H8
 9D 10003 H8

1A 71081 H8
 2A 79543 H8
 2C 78051 H8
 2F 79716 H8
 3A 77927 H8
 3G 79676 H8
 4A 30274 H8
 7F 78000 H8
 9D 79729 H8

1979

2A 20154 H9
 2F 20113 H9
 3A 10000 H9
 3G 20161 H9
 4A 11456 H9
 4E 11456 H9
 5E 20123 H9
 5G 35614 H9
 6E 37395 H9
 7G 39175 H9
 9D 20116 H9

2A 76951 H9
 2F 79498 H9
 3A 75770 H9
 3G 80437 H9
 4A 25366 H9
 4E 63813 H9
 5E 70443 H9
 5G 55722 H9
 6E 70738 H9
 7G 70839 H9
 9D 78409 H9

VIN Cont'd

<u>Begin VIN</u>	<u>End VIN</u>
<u>1980</u>	
1H 18353 JO	1H 18353 JO
1K 24940 JO	1K 24940 JO
2A 10692 JO	2A 25912 JO
2H 10002 JO	2H 10007 JO
3A 10177 JO	3A 33204 JO
3G 10172 JO	3G 25861 JO
3H 10061 JO	3H 25867 JO
4E 11137 JO	4E 11137 JO
6E 10001 JO	6E 25625 JO
7C 10774 JO	7C 25686 JO
7H 13858 JO	7H 24936 JO
9D 10002 JO	9D 25315 JO

VIN SYSTEM - Prior TO 1970

Prior to 1970, all Harley-Davidson motorcycles were registered by the engine number. This was the number referred to as the VIN. The engine number for these years was located on the left engine case on a raised boss. The boss bears the same pebbled effect as the surrounding area. The pre-1970 Harley-Davidson VIN consisted of two numeric characters followed by one or more Alpha characters and ending with four or more numeric characters. The following is a typical example.



The following list indicates the engine type and/or cubic displacement of the most common models. The Alpha characters indicate engine type and cubic displacement. The most common models are:

1. W-WL-WLD 45 cubic inch (cui) side valve, 1937-1954
2. K-KRM 45 cubic inch (cui) side valve 52-53
3. G-GA-GE 45 cubic inch (cui) side valve 3 wheeler 37-54
4. KH-KHK-KHRM 55 cubic inch (cui) side valve 54-56
5. XL-XLH-XLCH 55 cui overhead valve Sportster since 57
6. E-EL 61 cui overhead valve, Twin-1954
7. U-UL 74 cui side valve, Twin, 1937-1954
8. F-FL-FLH 74 cui overhead valve
9. UH-ULH 80 cui side valve, 1937-1954
10. S 125cc 2 stroke from 48 - 52
11. B 125cc 2 stroke from 55 - 59
12. ST-STU 165cc 2 stroke from 60 - 61
13. BT
14. BTU 165cc 2 stroke from 60 - 61
15. BTU 175 2 stroke from 62 - 66

Beginning in 1962 and continuing until 1969, the first numerical digit in the production number (the first number following the model designator) will be an even number for even years and an odd number for odd numbered years. If the sequential production number contains 5 rather than 4 digits, the first two numbers will be even for even years and odd for odd numbered years.

- Examples:
1. $\overline{62}$ FL $\overline{2}$ 439 - even
 2. $\overline{67}$ XLCH $\overline{1}$ 666 - odd
 3. $\overline{64}$ FL 10 $\overline{2}$ 21 - even
 4. $\overline{65}$ xlh 11631 - odd

HARLEY-DAVIDSON

VIN NUMBERS

<u>STYLE</u>	<u>BEGIN</u>	<u>END</u>
<u>1958</u>		
B	58B 1000	58B 2685
FL	58FL 1001	58FL 7108
G	58G 1001	58G 1966
ST	58ST 1001	58ST 3455
XLH	58XLH 1001	58XLH 2506
<u>1959</u>		
B	59B 1000	59B 2431
FLH, FL	59FLH 1001	59FLH 6755
G	59G 1001	59G 1778
ST	59ST 1001	59ST 3361
XLCH, XLH	59XLCH 1000	59XLCH 3059
<u>1960</u>		
A	60A 2000	60A 8927
BT	60BT 2000	60BT 6331
FL, FLH	60FL 2001	60FL 14009
G	60G 2001	60G 2695
XLH, XLCH	60XLCH 2020	60XLCH 6714
<u>1961</u>		
A	61A 1000	61A 3457
BT	61BT 1000	61BT 3596
G	61G 1001	61G 1033
FL, FLH	61FLH 1001	61FL 9966
XL, XLH, XLCH	61XL 1001	61XL 3946

Harley-Davidson VIN Number Cont'd

1962

<u>STYLE</u>	<u>BEGIN</u>	<u>END</u>
FL	62FL 2035	62FL 12047
FLH	62FLH 2001	62FLH 12105
AH	62AH 2000	62AH 4232
XLH	62XLH 2001	62XLH 6008
G	62G 2001	62G 2706
H	62H 2801	62H 4702
BT	62BT 2016	62BT 4997
BTF	62BTF 2024	62BTF 4974
BTH	62BTH 2022	62BTH 4985
C, CR	62C 2000	62C 2800
BTU	62BTU 2000	62BTU 4902

1963

FL	63FL 1037	63FL 9193
FLH	63FLH 1000	63FLH 9196
XLH	63XLH 1008	63XLH 3440
XLCH	63XLCH 1000	63XLCH 3396
G	63G 1428	63G 1591
H	63H 1151	63H 3703
AH	63AH 1000	63AH 1986
BT	63BT 1002	63BT 3753
BTH	63BTH 1000	63BTH 3762
BTU	63BTU 1370	63BTU 3712

1964

XLH	64XLH 2001	64XLH 6926
XLCH	64XLCH 2000	64XLCH 6927
XLA	64XLA 2525	64XLA 4155
R	64R 6001	64R 6049
FL	64FL 2162	64FL 12480
FLH	64FLH 2000	64FLH 12396
H	64H 2001	64H 4783
GE	64GE 2000	64GE 2686
AH	64AH 2000	64AH 2960
BT	64BT 2001	64BT 4446
BTH	64BTH 2000	64BTH 4445
C	64C 2000	64C 4230
D	64D 1548	64D 1588
DE	64DE 1301	64DE 1312

Harley-Davidson VIN Numbers Cont'd

<u>STYLE</u>	<u>BEGIN</u>	<u>END</u>
<u>1965</u>		
XLH	65XLH 1049	65XLH 7847
XLCH	65XLCH 1002	65XLCH 7851
FLH	65FLH 1001	65FLH 15012
GE	65GE 1001	65GE 1546
FL	65FL 1128	65FL 15010
M	65M 1002	65M 1907
AH	65AH 1002	65AH 1560
BT	65BT 1005	65BT 3194
BTH	65BTH 1001	65BTH 3267
C	65C 1200	65C 7010
CR	65CR 5000	65CR 5213
CRS	65CRS 5029	65CRS 7002
D, DE	65D 1314	65DE 1681
DC	65DC 1117	65DC 1159
H	65H 1000	65H 7032
<u>1966</u>		
FL	66FL 2000	66FL 18098
FLH	66FLH 2036	66FLH 18099
XLH	66XLH 2010	66XLH 10773
XLCH	66XLCH 2000	66XLCH 10802
<u>1967</u>		
FL	67FL 1073	67FL 15605
FLH	67FLH 1000	67FLH 15681
XLH	67XLH 1002	67XLH 9448
XLCH	67XLCH 1000	67XLCH 7851
<u>1968</u>		
FL	68FL 2002	68FL 16057
FLH	68FLH 2000	68FLH 14897
XLH	68XLH 2002	68XLH 14941
XLCH	68XLCH 2000	68XLCH 14942

Harley-Davidson VIN Number Cont'd

<u>STYLE</u>	<u>BEGIN</u>	<u>END</u>
	<u>1969</u>	
FL	69FL 1147	69FL 15361
FLH	69FLH 1000	69FLH 17392
XLH	69XLH 1001	69XLH 15866
XLCH	69XLCH 1000	69XLCH 15863

HARLEY-DAVIDSON BASIC MODEL HISTORY

1. The Knucklehead (1927-1947). This model gets its name from the unique type of engine used which was an overhead cam engine 61 or 74 cubic inches. The engine was mounted on a hard tail or rigid frame with large coil springs in the front (springer forks). The Knucklehead is frequently converted into a "chopper".
2. Hydro Glide (1948-1957). The hydro Glide also had a rigid frame which was slightly different from the Knucklehead frame. There is more clearance between the cross and case bars. Due to this additional space, it is easy to put a Knucklehead engine on a Hydro Glide but it is difficult to put a Hydro Glide engine in a Knucklehead. The front end had telehydraulic forks which are similar to shock absorbers. This type was equipped with a fork head lock.
3. "Hard Tail". (1957 frame only) The frame only was sold which was equipped with a steering head lock.
4. Duo Glide (1958-1965). This model has a pan head engine and a frame with a rear portion that swings. The swing arm can be adjusted. There are also conversion kits available that change the swing arm to a rigid tail. An electric starter could be purchased as an option on this model.
5. Electra Glide (from 1966). The electra Glide had an overhead cam and a pan-like engine that was more refined than previous models. This model has many of the same features as the Duo Glide and was equipped with a kick starter until 1968 after which the kick starter was an option. This model was the first one to have an electric starter.

Since 1965 many Harley-Davidson motorcycles were manufactured in Italy.

HODAKA

Hodaka Motorcycles, Tokyo, Japan and Pabatco, Athena, Oregon, USA
(Production discontinued - 1979)

VIN SYSTEM

B 12345

Number consists of letter prefix and five numerals.

VIN Location - On plate riveted to frame on left top of shock absorber mount or on bottom of left front frame gusset.

Engine Number - On front of right main engine case. Consists of five digit number preceded by P, M, H, J, K or L. Frame and engine numbers are not the same.

The following charts can be used as a guide to determine the proper frame or engine prefix according to model:

<u>MODEL</u>	<u>Letter Prefix</u>	<u>Frame Number</u>	<u>Letter Prefix</u>	<u>Engine Number</u>	<u>Displacement</u>
Ace 90 (90)	A	----	P	----	90cc
Ace 100 (92)	A	----	P	----	98cc
Ace 100B (92B)	A	----	P	----	98cc
Ace 100MX (93)	B	----	M	----	98cc
125 (94)	C	----	H	----	123cc
125MX (95)	D	----	J	----	123cc
100 (92C)	E	----	P	----	98cc
125/SC (97)	F	----	K	----	123cc
100/SR (98)	G	----	L	----	98cc
100/SL (99)	H	----	M	----	98cc
100/DS (01)	K	----	M	----	98cc
250/ED (71)	J	----	N	----	250cc

- A. Motorcycle frame number for Ace 90(90), Ace 100(92), Ace 100B (92B), and Ace 100MX(93) - a five digit number located on the frame above the left rear shock and preceded by an "A" or "B".

- B. Motorcycle frame number for 125's (94), (94A), (95), (97) and 100's (92C), (98), (99) - a five digit number located on the bottom of left front frame gusset and preceded by "C", "D", "E", "F", "G" or "H".

- C. Motorcycle engine number - a five digit number located on the front side of the right main engine case and preceded by a "P", "M", "H", "J", "K" or "L".

Neither the frame or engine numbers are protected by logos.

HONDA

Honda motorcycles are manufactured in Japan, Belgium, Brazil and the United States. According to information from R.L. Polk and Company, Detroit, quoted in "USA Today", July 15, 1985, Honda outsold all other manufacturers combined in the first quarter of 1985. Honda's share of newly registered motorcycles in the U.S. in the same period was 58.66% according to the same source.

Since Honda is the motorcycle most frequently sold, it certainly follows that it is the most frequently stolen. At the time of this writing there are 11,250 unrecovered Honda motorcycles in the State of California. When one considers that there are a total of 26,231 unrecovered motorcycles in that state, the importance of Honda VIN information is obvious.

In the United States, Honda motorcycle information may be obtained through American Honda Motor Company Inc. 100 West Alondra Boulevard Gardena, Ca. 90247.

VIN SYSTEM: Honda motorcycles are following the 17 digit VIN system with certain exceptions. The last 14 characters of the VIN are stamped into the headstock. The full 17 digit VIN is recorded on the Federal Certification label which is also located on the headstock. Off road machines are stamped with 14 characters of the VIN. They do not have a Federal Certification label.

Honda motorcycles designed for road or street use should be registered with the complete 17 digit VIN as shown on the certification label. If this certificate has been removed a "trial and error" series of inquiries can be made using the alternative World Make Identifiers until a "hit" is made.

VIN 1986-1981

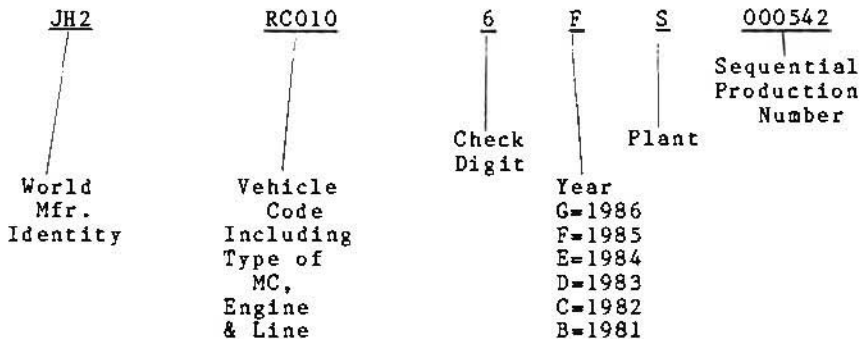

World Manufacturer Identity:

JH2 = Honda - Japan
1HF = Honda - USA
YC1 = Honda - Belgium
9C2 = Honda - Brazil

Plant:

C = Saitama - Japan
M = Hamamatsu - Japan
S = Susuka - Japan
K = Kumamoto - Japan
B = Belgium
A = USA
R = Brazil

Vehicle Codes - This information follows for Honda motorcycles from 1985-1974.

VIN - 1980 and prior



The model designator generally contained a repeat of the model of the motorcycle, but not always. For example, the model XR80 has a VIN prefix of HE01 - Full examples of models and VINS are listed in subsequent material.

VIN Locations - Left side of headstock. This most frequently applies to models with tubular steel frame construction.

On vehicles with formed sheet metal frame construction on left side, above crankcase.

On mini bikes - left rear axle mount.
On Mopeds - lower left side of frame at main stand bracket.

Engine Numbers -

The engine number is not a VIN derivative nor a repeat of the VIN. It is comprised of a model code and engine sequential production number.

Example: RC01E - 2204182

All engines are designated by the letter "E" between the model prefix and the sequential production number.

Engine Number Locations:

- 1 - Left upper crankcase behind cylinder (larger engines).
- 2 - Right upper crankcase surface behind cylinder (medium engines).
- 3 - Lower left side of crankcase (smaller engines).

The dies used by Honda for stamping engine and frame numbers are unique as the following illustrations show.

1 2 3 4 5 6 7 8 9 0
A B C E L M P R S T Z

The following chart lists model numbers and beginning VINs and engine numbers from 1985-1978.

1986 HONDA MOTORCYCLES

<u>MODEL</u>		<u>VIN NUMBER</u>	<u>CARB I.D.</u>	<u>ENGINE NUMBER</u>
NB50M		JH2AF090*GS100001		AF05E-3100001
NQ50		JH2AF060*GS200001		AF05E-2200001
NQ501		JH2AF061*GS200001		AF05E-2200001
TG50		JH2TB100*GS100001		TB08E-3100001
Z50R		JH2AB020*GS700001		AB02E-5700001
TRX70		JH3TE100*GC100001		TE10E-1000001
CH80	(49)	JH2JF030*GS100001	VC61C	HF03E-2100001
CH80	(CA)	JH2HF031*GS100001	VC61C	HF03E-2100001
CR80R		JH2HE040*GK300001		HE04E-5300001
XR80R		JH2HE010*GK700001		HE01E-5700001
XR100R		JH2HE030*GK500001		HE03E-5500001
CT110	(49)	JH2JD010*GS500001	PB10D	JD01E-5500001
CT110	(CA)	JH2JD011*GS500001	PB10G	JD01E-5500001
ATC125M		JH3TE010*GK200001		TE01E-2200001
CB125S	(49)	9C2JC130*GR200001		JC13E-2000001
CB125S	(CA)	9C2JC131*GR200001		JC13E-2000001
CR125R		JH2J3010*GC700001		JE01E-2700001
TRX125		JH3TE050*GC100001		TE05S-2100001
XL125S	(49)	9C2JD020*GR200001		JD02E-5200001
XL125S	(CA)	9C2JD021*GR200001		JD02E-5200001
CH150	(49)	JH2KF010*GK100001		KF01E-5100001
CH150	(CA)	JH2KF011*GK100001		KF01E-5100001
CH150D	(49)	JH2KF012*GK100001	VE03B	KF01E-5100001
CH150D	(CA)	JH2KF013*GK100001	VE04B	KF01E-5100001
ATC200S		JH3TB053*GK500001		TB05E-2500001
ATC200X		JH3TB052*GK500001		TB05E-6300001
TLR200	(49)	JH2MD090*GK000001	P07A	MD19E-5200001
TLR200	(CA)	JH2MD091*GK000001	P08A	MD19E-5200001
TRX200SX		JH3TE030*GK000001		TE03E-5000001
XR200R		JH2ME050*GK200001		ME05E-5200001
ATC250ES		JH3TE040*GM200001		TE04E-6000001
ATC250R		JH3TB060*GC500001		TB06E-2500001
ATC250SX		JH3TE042*GM100001		TE04E-6000001
CH250	(49)	JH2MF010*GK100001	VE06D	MF01E-5100001
CH250	(CA)	JH2MF011*GK100001	VE13B	MF01E-5100001
CMX250	(49)	JH2MC130*GK100001	VE08A	MC13E-5100001
CMX250C	(CA)	JH2MC131*GK100001	VE18A	MC13E-5100001
CMX250CD	(49)	JH2MC132*GL100001	VE084	MC13E-5100001
CMX250	(CA)	JH2MC133*GK100001	VE18A	MC13E-5100001

1986 HONDA MOTORCYCLES VIN LIST CONT'D

<u>MODEL</u>		<u>VIN NUMBER</u>	<u>CARB I. D.</u>	<u>ENGINE NUMBER</u>
CN250	(49)	JH2MF020*GK000001	VE14A	MF02E-5100001
CN250	(CA)	JH2MF021*GK000001	VE15A	MF02E-5100001
CR250R		JH3ME030*GC900001		ME03E-2800001
TRX250		JH3TE060*GC100001		TE06E-5100001
TRX250R		JH2TB060*GC000001		TB06E-1000001
XL250R	(49)	JH2MD110*GK200001	PH10A	MD11E-5200001
XL250R	(CA)	JH2MD111*GK200001	PH10B	MD11E-5200001
XR250		JH2ME060*GK200001		ME06E-5200001
ATC350X		JH3TE080*GM100001		TE08E-5100001
FL350		JH3RT020*GC200001		TE02E-2100001
TRX350		JH3TE070*GM000001		TE07E-5000001
CB450SC	(49)	JH2PC054*GM400001	VB2EA	PC05E-5400001
CB450SC	(CA)	JH2PC055*GM400001	VB2FB	PC05E-5400001
CMX450C	(49)	JH2PC170*GM000001	VE24A	PC17E-2000001
CMX450C	(CA)	JHCPC171*GM000001	VE28A	PC17E-2000001
CR500R		JH2PE020*GC500001		PE02E-5500001
VF500F	(49)	JH2PC120*GM200001	VD31A	PC12E-2200001
VF500F	(CA)	JH2PC121*GM200001	VD32A	PC12E-2200001
VT500C	(49)	JH2PC080*GM300001	VD6HD	PC08E-2300001
VT500C	(CA)	JH2PC081*GM300001	VD6LD	PC08E-2300001
XL600R	(49)	JH2PD030*GK300001	PH68G	PDO3E-5300001
XL600R	(CA)	JH2PD031*GK300001	PH68H	PDO3E-5300001
XR600R		JH2PE040*GK100001		PE04E-5300001
CB700SC	(49)	JH2RC200*GM200001	VE66A	RC20E-2200001
CB700SC	(CA)	JH2RC201*GM200001	VE77B	RC20E-2200001
VF700C	(49)	JH2RC210*GM200001	VD06B	RC21E-2200001
VF700C	(CA)	JH2RC211*GM200001	VD07B	RC21E-2200001
VFR700F	(49)	JH2RC260*GM000001	VDBAB	RC26E-2000001
VFR700F	(CA)	JH2RC261*GM000001	VDBCA	RC26E-2000001
VFR700F11	(49)	JH2RC262*GM000001	VDBAB	RC26E-2000001
VFR700F11	(CA)	JH2RC263*GM000001	VDBCA	RC26E-2000001
VT700C	(49)	JH2RC190*GM200001	VD7CB	RC19E-2200001
VT700C	(CA)	JH2RC191*GM200001	VD7BC	RC19E-2200001
VFR750F	(49)	JH2RC240*GM000001	VDBAA	RC24E-2000001
VFR750F	(CA)	JH2RC241*GM000001	VDBBA	RC24E-2000001
VF1000R	(49)	JH2SC160*GM100001	VD77A	SC16E-2000001
VF1000R	(CA)	JH2SC161*GM100001	VD78A	SC16E-2200001
VF1100C	(49)	IHFSC120*GA300101	VD70C	SC12E-2300001
VF1100C	(CA)	IHFSC121*GA300101	VD79A	SC12E-2300001
VT1100C	(49)	IHFSC180*GA100101	VD7DC	SC18E-2100001
VT1100C	(CA)	IHFSC181*GA100101	VD7FA	SC18E-2100001

1986 HONDA MOTORCYCLES VIN LIST CONT'D

<u>MODEL</u>		<u>VIN NUMBER</u>	<u>CARB I.D.</u>	<u>ENGINE NUMBER</u>
GL12SE1	(49)	JH2SC146*GC200001		SC14E-2600001
GL12SE1	(CA)	JH2SC147*GC200001		SC14E-2600001
GL12SE1	(49)	1HFSC146*GA200101		SC14E-2600001
GL12SE1	(CA)	1HFSC147*GA200101	N/A	SC14E-2600001
GL1200A	(49)	JH2SC142*GC200001	N/A	SC14E-2600001
GL1200A	(CA)	JH2SC145*GC200001		SC14E-2600001
GL1200A	(49)	1HFSC142*GA200101	VD53C	SC14E-2600001
GL1200A	(CA)	1HFSC145*GA200101	VD55C	SC14E-2600001
GL12001	(49)	JH2SC141*GC200001		SC14E-2600001
GL12001	(CA)	JH2SC144*GC200001		SC14E-2600001
GL12001	(49)	1HFSC141*GA200101	VD53C	SC14E-2600001
GL12001	(CA)	1HFSC144*GA200101	VD55C	SC14E-2600001

1985 VIN INFORMATION

<u>MODEL</u>	<u>VIN NUMBER</u>	<u>CARB I.D.</u>	<u>ENGINE NUMBER</u>
NB50M	JH2AF090*FS000001	PA04G	AF05E-3000001
NQ50	JH2AF060*FS100001	PA29C	AF05E-2100001
NQ50I	JH2AF061*FS100001		AF05E-2100001
TG50F	JH2TB100*FS000001		AF10E-2000001
Z50R	JH2AB020*FS600001		AB02E-5600001
CR60R	JH2DE010*FK200001		DE01E-5200001
ATC70	JH3TB030*FK000001	PB38A	TB03E-3000001
CH80	(49) JH2HF03*FK000001	VC61A	HF03E-2000001
CH80	(CA) JH2HF031*FS000001	VC61A	HF03E-2000001
CR80R	JH2HE040*FK200001	PE67B	HE04E-5200001
NH80	(49) JH2HF010*FK200001	PB54E	HF01E-2200001
XL80S	(49) JH2HD040*FK500001	PF66A	HD04E-5400001
XL80S	(CA) JH2HD041*FK500001	PF66A	HD04E-5400001
XR80R	JH2HE010*FK600001	PC10D	HE01E-5600001
XL100S	(49) JH2HD050*FK400001	PD82A	HD05E-5400001
XL100S	(CA) JH2HD051*FK400001	PD82A	HD05E-5400001
XR100R	JH2HE030*FK400001	PD36D	HE03E-5400001
ATC110	JH3TB020*FC600001	PB20A	TB02E-2700001
ATC125M	JH3TE010*FC100001	PB20A	TE01E-2100001
CB125S	(49) 9C2JC13*FR100001	PD17F	JC13E-2100001
CB125S	(CA) 9C2JC131*FR100001	PD17H	JC13E-2100001
CR125R	JH2JE010*FC600001	PE35D	JE01E-2600001
TRX125	JH3TE050*FC000001	PB01B	TE05E-2000001
XL125S	(49) 9C2JD020*FR100001	PD13A	JD02E-5500001
XL125S	(CA) 9C2JD021*FR100001	PD13F	JD02E-5500001
CH150	(49) JH2KF010*FK000001	VE03A	KF01E-5000001
CH150	(CA) JH2KF011*FK000001	VE40A	KF01E-5000001
CH150D	(49) JH2KF012*FK000001	VE03A	KF01E-5000001
CH10D	(CA) JH2KF013*FK000001	VE40A	KF01E-5000001
ATC200ES	JH3TB055*FC400001		TB05E-6100001
ATC200M	JH3TB054*FK400001	PD55C	TB05E-5400001
ATC200S	JH3TB053*FK400001	PD85D	TB05E-2500001
ATC200X	JH3TB052*FK400001	PD62B	TB05E-6200001
XR200R	JH2ME050*FK100001	PH32A	ME05E-5100001
ATC250ES	JH3TE040*FM000001	QA10A	TE04E-5000001
ATC250R	JH3TB060*FC400001	PE37A	TB06E-2400001
ATC250SX	JH3TE042*FM000001	QA02A	TE04E-5000001
CH250	(49) JH2MF010*FK000001	VE064A	MF01E-5000001
CH250	(CA) JH2MF011*FK000001	VE13A	MF01E-5000001
CMX250	(49) JH2MC130*FK000001	VE08A	MF02E-2000001

1985 VIN INFORMATION CONT'D

<u>MODEL</u>		<u>VIN NUMBER</u>	<u>CARB I.D.</u>	<u>ENGINE NUMBER</u>
CMX250	(CA)	JH2MC131*FK000001	VE18A	MFO2E-2000001
CR250R		JH2ME030*FC700001	PJ11A	ME03E-2700001
TRX250		JH3TE060*FC000001	QA04A	TE06E-5000001
XL250R	(49)	JH2MD110*FK100001	PH10A	MD11E-5100001
XL250R	(49)	JH2MD111*FK100001	PH10B	MD11E-5100001
XR250R		JH2ME060*FK100001	PH41A	ME06E-5100001
ATC350X		JH3TE080*FM000001	QA05A	TE08E-5000001
FL350		JH3TE020*FC100001	PE32A	TE02E-2100001
TRX350		JH3TE070*FM000001		TE07E-5000001
XL350R	(49)	JH2ND030*FK100001	PH70A	ND03E-5100001
XL350R	(CA)	JH2ND031*FK100001	PH70B	ND03E-5100001
XR350R		JH2NE010*FK200001	PD11D	NE01E-5200001
CB450SC	(49)	JH2PC054*FM300001	VB2EA	PC05E-5300001
CB450SC	(CA)	JH2PC055*FM300001	VB2FA	PC05E-5300001
CR500R		JH2PE020*FC400001	PJ21A	PE02E-5400001
VF500C	(49)	JH2PC130*FM100001	VD58C	PC13E-2100001
VF500C	(CA)	JH2PC131*FM100001	VD59B	PC13E-2100001
VF500F	(49)	JH2PC120*FM100001	VD56D	PC12E-2100001
VF500F	(CA)	JH2PC121*FM100001	VD57B	PC12E-2100001
VT500C	(49)	JH2PC080*FM200001	VD6HC	PC08E-2200001
VT500C	(CA)	JH2PC081*FM200001	VD6LA	PC08E-2200001
XL600R	(49)	JH2PD030*FK200001	PH68A	PD03E-5200001
XL600R	(CA)	JH2PD031*FK200001	PH68B	PD03E-5200001
XR600R		JH2PE040*FK000001	PH52A	PE04E-5200001
CB650SC	(49)	JH2RC130*FM200001	VE54A	RC13E-2200001
CB650SC	(CA)	JH2RC131*FM200001	VE75A	RC13E-2200001
CB700SC	(49)	JH2RC200*FM100001	VE65A	RC20E-2100001
CB700SC	(CA)	JH2RC201*FM100001	VE77A	RC20E-2100001
VF700C	(49)	JH2RC210*FM100001	VD06A	RC21E-2100001
VF700C	(CA)	JH2RC211*FM100001	VD07A	RC21E-2100001
VF700F	(49)	JH2RC230*FM100001	VD52D	RC23E-2100001
VF700F	(CA)	JH2RC231*FM100001	VD05B	RC23E-2100001
VF700S	(49)	JH2RC220*FM100001	VD50E	RC22E-2100001
VF700S	(CA)	JH2RC221*FM100001	VD02A	RC22E-2100001
VT700C	(49)	JH2RC190*FM100001	VD7CB	RC19E-2100001
VT700C	(CA)	JH2RC191*FM100001	VD7BB	RC19E-2100001
VF1000R	(49)	JH2SC160*FM000001		SC16E-2100001
VF1000R	(CA)	JH2SC161*FM000001		SC16E-2100001
VF1100C	(49)	IHFSC120*FA200001	VD70C	SC12E-2200001
VF1100C	(CA)	IHFSC121*FA200001	VD76A	SC12E-2200001
VF1100S	(49)	IHFSC170*FA100001	VD71A	SC17E-2100001

1985 VIN INFORMATION CONT'D

<u>MODEL</u>		<u>VIN NUMBER</u>	<u>CARB I.D.</u>	<u>ENGINE</u>
VF1100S	(CA)	IHFSC171*FA100001	VD74A	SC17E-2100001
VF1100S	(49)	JH2SC170*FM100001	VD71A	SC17E-2100001
VF1100S	(CA)	JH2SC171*FM100001	VD74A	SC17E-2100001
VT1100C	(49)	JH2SC180*FM000001	VD7DA	SC18E-2000001
VT1100C	(CA)	JH2SC181*FM000001	VD7EA	SC18E-2000001
VT1100C	(49)	IHFSC180*FA002001	VD7DA	SC18E-2000001
VT1100C	(CA)	IHFSC181*FA002001	VD7EA	SC18E-2000001
GL1200L	(49)	IHFSC146*FA100101	N/A	SC14E-2500001
GL1200L	(CA)	IHFSC147*FA100101	N/A	SC14E-2500001
GL1200L	(49)	JH2SC146*FC100001	N/A	SC14E-2500001
GL1200L	(CA)	JH2SC147*FC100001	N/A	SC14E-2500001
GL1200A	(49)	IHFSC142*FA100101	VD53B	SC14E-2400001
GL1200A	(CA)	IHFSC145*FA100101	VD55B	SC14E-2500001
GL1299A	(49)	JH2SC141*FC100001	VD53B	SC14E-2500001
GL1200A	(CA)	JH2SC145*FC100001	VD55B	SC14E-2500001
GL1200A	(49)	IHFSC141*FA100101	VD53B	SC14E-2500001
GL12001	(CA)	IHFSC144*FA100101	VD55B	SC14E-2500001
GL12001	(49)	JH2SC141*FC100001	VD53B	SC14E-2500001
GL12001	(CA)	JH2SC144*FC100001	VD55B	SC14E-2500001
VF1100S	(CA)	IHFSC171*FA100001	VD74A	SC17E-2100001
VF1100S	(49)	JH2SC170*FM100001	VD71A	SC17E-2100001
VF1100S	(CA)	JH2SC171*FM100001	VD74A	SC17E-2100001
VT1100C	(49)	JH2SC180*FM000001	VD7DA	SC18E-2000001

1984 HONDA MOTORCYCLES

<u>MODEL</u>	<u>VIN NUMBER</u>	<u>CARB I.D.</u>	<u>ENGINE NUMBER</u>
NB50M	JH2AB070*EK100001	PA05A	AB07E-5100001
NN50MD	JH2TB090*ES000001	PA27C	TB08E-2000001
NQ50	JH2AF060*ES000001	PA29C	AF05E-2000001
NQ501	JH2AF061*ES000001	PA29C	AF05E-2000001
Z50R	JH2AB020*ES500001	PA03B	AB02E-5500001
CR60R	JH2DE010*EK100001	PE62A	DE01E-5100001
ATC70	JH3TB020*EC900001	PB38A	TB03E-2900001
ATC70	JH3TB030*EK900001	PB38A	TB03E-2900001
CR80R	JH2HE040*EK100001	PE67	HE04E-5100001
NH80	(49) JH2HF010*ES100001	PB54D	HF01E-2100001
XL80S	(50) JH2HD040*EK400001	PF66A	HD04E-5400001
XR80R	JH2HE010*EL500001	PC10C	HE01E-5500001
XL100S	(50) JH2HD050*EK300001	PD82A	HD05E-5400001
XR100	JH2HE030*EK300001	PD36A	HE03E-5300001
ATC110	JH3TB020*EC500001	PB20A	TB02E-2600001
CT110	(50) JH3JD010*ES400001	PB10A	JD01E-5400001
ATC125M	JH3TE010*EC000012	PB20A	TE01E-2000001
CB125S	(49) 9C2JC130*ER010001	PD17F	JC13E-2000001
CB125S	(CA) 9C2JC131*ER010001	PD17F	JC13E-2000001
CH125	(49) JH2JF020*EK000001	VE01A	JF02E-5000001
CH125	(CA) JH2JF021*EK000001	VE01A	JF02E-5000001
CR125R	JH2JE010*EC500001	PE35D	JE01E-2500001
NH125	(49) JH2JF010*ES000001	PB02B	JF01E-2000001
XL125S	(49) JH2JD020*EK400001	PD13A	JD02E-5400001
XL125S	(CA) JH2JD021*EK400001	PD13A	JD02E-5400001
ATC200ES	JH3TB055*EC300001	PD55A	TB05E-6000001
ATC200S	JH3TB053*EC300001	PD35A	TB05E-2300001
ATC200M	JH3TB054*EC300001	PD55A	TB05E-5300001
ATC200X	JH3TB052*EC300001	PD62B	TB05E-6100001
ATC200X	JH3TB052*EK300001	PD62B	TB05E-6100001
TRX200	JH3TE030*EC000001	PD55A	TE03E-2000001
XL200R	(49) JH2MD060*EK100001	PD61A	MD06E-5100001
XL200R	(CA) JH2MD061*EK100001	PD61A	MD06E-5100001
XR200	JH2ME020*EK500001	PD32A	ME02E-5500001
XR200R	JH2ME050*EK000001	PH31A	ME05E-5000001
ATC250R	JH2TB060*EC300002	PE30A	TB06E-2300001
FL250	JH2TB040*EC700001	092B	TB04E-2700001
XL250R	(49) JH2MD110*EK000001	PH82A	MD11E-5000001
XL250R	(CA) JH2MD111*EK000001	PH82A	MD11E-5000001
XR250R	JH2ME060*EK000001	PH42A	ME06E-5000001
XL350R	(49) JH2ND030*EM000001	PH80A	ND03E-5000001

1984 HONDA MOTORCYCLES CONT'D

MODEL	VIN NUMBER	CARB I.D.	ENGINE NUMBER
XL350R (CA)	JH2NDO31*EM000001	PH81A	NDO3E*5000001
XR350R	JH2NE010*EM100001	PH05A	NE01E-5100001
CR500R	JH2PE020*EC300001	PE45D	PE02E-5300001
VF500C (49)	JH2PC130*EM000001	VD58A	PC13E-2000001
VF500C (CA)	JH2PC131*EM000001	VD59A	PC13E-2000001
VF500F (49)	JH2PC120*EM000001	VD56A	PC12E-2000001
VF500F (CA)	JH2PC121*EM000001	VD57A	PC12E-2000001
VT500C (49)	JH2PC080*EM100001	VD6HA	PC08E-2100001
VT500C (CA)	JH2PC081*EM100001	VD6KA	PC08E-2100001
VT500FT (49)	JH2PC100*EM100001	VD6JA	PC10E-2100001
VT500FT (CA)	JH2PC101*EM100001	VD6LA	PC10E-2100001
XR500R	JH2PE030*EM100001	PH51A	PE03E-5100001
XL600R (49)	JH2PDO30*EM100001	PH64A	PDO3E-5100001
XL600R (CA)	JH2PDO31*EM100001	PH66A	PDO3E-5100001
CB650SC (49)	JH2RC130*EM100001	VE54A	RC13E-2100001
CB650SC (CA)	JH2RC131*EM100001	VE75A	RC13E-2100001
CB700SC (49)	JH2RC200*EM000001	VE65A	RC20E-2000001
CB700SC (CA)	JH2RC021*EM000001	VE77A	RC20E-2000001
VF700C (49)	JH2RC210*EM000001	VD51A	RC21E-2000001
VF700C (CA)	JH2RC211*EM000001	VD03A	RC21E-2000001
VF700F (49)	JH2RC230*EM000001	VD52D	RC23E-2000001
VF700F (CA)	JH2RC231*EM000001	VD05B	RC23E-2000001
VF700S (49)	JH2RC220*EM000001	VD50E	RC22E-2000001
VF700S (CA)	JH2RC221*EM000001	VD02A	RC22E-2000001
VT700C (49)	JH2RC190*EM000001	VD7CA	RC19E-2000001
VT700C (CA)	JH2RC191*EM000001	VD7BA	RC19E-2000001
VF750F (49)	JH2RC150*EM100001	VD52C	RC15E-2100001
VF750F (CA)	JH2RC151*EM100001	VD05A	RC15E-2100001
VF1000F (49)	JH2SC150*EM000001	VD52B	SC15E-2000001
VF1000F (CA)	JH2SC151*EM000001	VD05A	SC15E-2000001
VF1100C (49)	IHFSC120*EA103001	VD70C	SC12E-2100001
VF1100C (CA)	IHFSC121*EA103001	VD76A	SC12E-2100001
VF1100S (49)	IHFSC170*EA002001	VD70C	SC17E-2000001
VF1100S (CA)	IHFSC171*EA002001	VD76A	SC17E-2000001
GL1200 (49)	JH2SC140*EC000001	VD53A	SC14E-2400001
GL1200 (49)	IHFSC140*EA000001		SC14E-2400001
GL1200 (CA)	JH2SC143*EC000001	VD55A	SC14E-2400001
GL1200 (CA)	IHFSC143*EA000001		SC14E-2400001
GL1200A (49)	JH2SC142*EC000001	VD53A	SC14E-2400001
GL1200A (49)	IHFSC142*EA000001		SC14E-2400001
GL1200A (CA)	JH2SC145*EC000001	VD55A	SC14E-2400001
GL1200A (CA)	IHFSC145*EA000001		SC14E-2400001
GL1200I (49)	JH2SC141*EC000001	VD53A	SC14E-2400001

1984 HONDA MOTORCYCLES CONT'D

<u>MODEL</u>		VIN NUMBER	CARB I.D.	ENGINE NUMBER
GL1200I	(49)	IHFSC141*EA000001		SC14E-2400001
GL1200I	(CA)	JH2SC144*EC000001	VD55A	SC14E-2400001
GL1200I	(CA)	IHFSC144*EA000001		SC14E-2400001

1983 HONDA MOTORCYCLES

<u>MODEL</u>	<u>VIN NUMBER</u>	<u>CARB I.D.</u>	<u>ENGINE NUMBER</u>
NB50M	JH2AB070*DK000001		AB07E-5000001
NC50	JH2AB100*DS100001		AB10E-2100001
NC50I	JH2AB101*DS100001		AB10E-2100001
NU50	JH2AB132*DK000001		AB13E-2100001
NU50I	JH2AB133*DK000001		AB13E-2100001
NU50M	JH2AB130*DK000001		AB13E-2100001
NU50MI	JH2AB131*DK000001		AB13E-2100001
PA50II	YC1AB090*DB300001		AB09E-2400001
Z50R	JH2AB020*DS400001		AB02E-5400001
CR60R	JH2DE010*DK000001		DE01E-5000001
ATC70	JH3TB030*DC800001		TB03E-2800001
C70	JH2DA010*DS300001	PB15A	DA01E-2300001
CR80R	JH2HE040*DK000001		HE04E-5000001
NH80 (49)	JH2HF010*DS000001	PB54D	HF01E-2000001
XL80S (CA)	JH2HD041*DK300001	PF66A	HD04E-5300001
XL80S (49)	JH2HD040*DK300001	PF66A	HD04E-5300001
XR80	JH2HE010*DK400001		HE01E-5400001
XL100S (CA)	JH2HD051*DK200001	PD37A	HD05E-5300001
XL100S (49)	JH2HD050*DK200001	PD37A	HD05E-5300001
XR100	JH2HE030*DK200001		HE03E-5200001
ATC110	JH3TB020*DC400001		TB02E-2500001
CT110	JH2JD010*DS300001	PB10A	JD01E-5300001
CR125R	JH2JE010*DC400001		JE01E-2400001
ATC185S	JH3TB010*DC300001		TB01E-3000001
XL185S (CA)	JH2MD021*DK400001	PD13D	MD02E-5400001
XL185S (49)	JH2MD020*DK400001	PD13D	MD02E-5400001
ATC200	JH3TB050*DC200001		TB05E-2200001
ATC200E	JH3TB051*DC200001		TB05E-5100001
ATC200X	JH3TB052*DC200001		TB05E-6000001
XL200R (CA)	JH2MD061*DK000001	PD13D	MD06E-5000001
XL200R (49)	JH2MD060*DK000001	PD13D	MD06E-5000001
XR200	JH2ME020*DK400001		ME02E-5400001
XR200R	JH2ME040*DK200001		ME04E-5200001
ATC250R	JH3TB060*DC200001		TB06E-2200001
CM250C (CA)	JH2MC061*DK100001	VB19A	MC06E-2100001
CM250C (49)	JH2MC060*DK100001	VB17A	MC063-2100001
CR250R	JH2ME030*DC500001		ME03E-2500001

1983 HONDA MOTORCYCLES CONT'D

<u>MODEL</u>	<u>VIN NUMBER</u>	<u>CARB I.D.</u>	<u>ENGINE NUMBER</u>
FL250	JH3TB040*DC600001		TB04E-2600001
XL250R (CA)	JH2MD031*DM100001	PD74A	MDO3E-5100001
XL250R (49)	JH2MD030*DM100001	PD74A	MDO3E-5100001
XR350R	JH2NE010*DM000001		NE01E-5000001
CB450SC	JH2PC054*DM100001	VB22N	PC053-5100001
CM450A	JH2PC052*DM100001	VB24E	PC05E-6100001
CM450E	JH2PC053*DM100001	VB220	PC05E-4100001
CR480R	JH2PE020*DC200001		PE02E-5200001
FT500	JH2PC070*DM100001	VB10A	PC07E-2100001
VT500C	JH2PC080*DM000001	VD6HA	PC08E-2000001
VT500FT	JH2PC100*DM000001	VD6JA	PC10E-2000001
XR500R	JH2PE030*DM000001		PE03E-5000001
CB550SC	JH2PC090*DM000001	VE62A	PC09E-2000001
XL600R	JH2PD030*DM000001	PH60A	PD03E-5000001
CB650SC	JH2RC130*DM000001	VE54A	RC13E-2000001
CX650C	JH2RC110*DM000001	VB2AC	RC11E-2000001
CX650TC	JH2RC160*DM000001	N/A	RC16E-2000001
GL650	JH2RC100*DM000001	VB2AA	RC10E-2000001
GL650I	JH2RC101*DM000001	VB2AA	RC10E-4000001
CB750SC	JH2RC012*DM100001	VB42A	RC01E-2400001
VF750C	JH2RC071*DM100001	VD51C	RC07E-4100001
VF750F	JH2RC150*DM000001	VD52A	RC15E-2000001
VF750S	JH2RC070*DM100001	VD50C	RC07E-2100001
VT750C	JH2RC140*DM000001	VD7AA	RC143-2000001
CB1000C	IHFSC100*DA000001		SC10E-2000001
CB1000C	JH2SC100*DC000001	VB55A	SC10E-2000001
CB1100F	JH2SC110*DM000001	VB56A	SC11E-2000001
GL1100	IHFSC020*DA300001		SC02E-2300001
GL1100	JH2SC020*DC300001	VB48C	SC02E-2300001
GL1100A	IHFSC022*DA300001		SC02E-2300001
GL1100A	JH2SC022*DC300001	VB48C	SC02E-2300001
GL1100I	IHFSC021*DA300001		SC02E-2300001
GL1100I	JH2SC021*DC300001	VB48C	SC02E-2300001
VF1100C	JH2SC120*DM000001	VD70A	SC12E-2000001

1982 HONDA MOTORCYCLES

<u>MODEL</u>	<u>VIN NUMBER</u>	<u>CARB I.D.</u>	<u>ENGINE NUMBER</u>
MB5	JH2AC010*CK000001		AC01E-2000001
NC50	JH2AB100*CS000001		AB10E-2000001
NC50I	JH2AB101*CS000001		AB10E-2000001
NU50	JH2AB132*CK000001		AB13E-2000001
NU50	JH2AB132*CS000001		AB13E-2000001
NU50I	JH2AB133*CK000001		AB13E-2000001
NU50I	JH2AB133*CS000001		AB13E-2000001
NU50M	JH2AB130*CK000001		AB13E-2000001
NU50M	JH2AB130*CS000001		AB13E-2000001
NU50MI	JH2AB131*CK000001		AB13E-2000001
NU50MI	JH2AB131*CS000001		AB13E-2000001
NX50	JH2AB040*CS100001		AB04E-2100001
PA50II	YC1AB090*CB200001		AB09E-2100001
Z50R	JH2AB020*CS300001		AB02E-5300001
ATC70	JH2TB0300CC700001		TB03E-2700001
C70	JH2DA010*CS200001	PB15A	DA01E-2200001
CT70	JH2DD010*CS300001	PB16A	DD01E-5300001
CR80R	JH2HE020*CK200001		HE02E-5200001
XL80S	JH2HD040*CK200001	PF65A	HD04E-5200001
XR80	JH2HE010*CK300001		HE01E-5300001
XL100S	JH2HD050*CK100001	PD37A	HD05E-5200001
XR100	JH2HE030*CK100001		HE03E-5100001
ATC110	JH3TB0200CC300001		TB02E-2300001
CT110	JH2JD010*CS200001	PB10A	JD01E-5200001
CB125S	JH2JC040*CK800001	PD24A	JC04E-2800001
CR125R	JH2JE010*CC300001		JE01E-2300001
XL125S	JH2JD020*CK300001	PD13A	JD02E-5300001
ATC185S	JH3TB0100CC200001		TB01E-2200001
XL185S	JH2MD020*CK300001	PD13B	MD02E-5300001
ATC200	JH3TB0500CC100001		TB05E-2100001
ATC200E	JH3TB0510CC100001		TB05E-2100001
CM200T	JH2MC010*CM200001	PD23A	MC01E-2200001
XR200	JH2ME020*CK300001		ME02E-5300001
XR200R	JH2ME040*CK100001		ME04E-5100001
ATC250R	JH3TB0600CC100001		TB06E-2100001
CM250C	JH2MC060*CK000001	VB15A	MC06E-2000001
CR250R	JH2ME030*CC400001		ME03E-2400001
FL250	JH3TB0400CC500001		TB04E-2500001
XL250R	JH2MD030*CM000001	PD74A	MD03E-5000001
XR250R	JH2ME010*CM300001		ME01E-5300001
CB450SC	JH2PC054*CM000001	VB22G/VB22J	PC05E-5000001

1982 HONDA MOTORCYCLES CONT'D

<u>MODEL</u>	<u>VIN NUMBER</u>	<u>CARB I.D.</u>	<u>ENGINE NUMBER</u>
CB450T	JH2PC050*CM000001	VB22L	PC05E-7000001
CM450A	JH2PC052*CM000001	VB24E	PC05E-6000001
CM450C	JH2PC051*CM000001	VB22G	PC05E-2000001
CM450E	JH2PC053*CM000001	VB22J	PC05E-4000001
CR480R	JH2PE020*CC100001		PE02E-5100001
CX500C	JH2PC010*CM300001	VB25A	PC10E-2300001
CX500TC	JH2PC030*CM000001	N/A	PC03E-2000001
FT500	JH2PC070*CM000001	VB10A	PC07E-2000001
GL500	JH2PC020*CM100001	VB29A	PC02E-2100001
GL500I	JH2PC021*CM100001	VB29A	PC02E-2100001
XL500R	JH2PD020*CM000001	PD77A	PD02E-5000001
XR500R	JH2PE010*CM300001		PE01E-5300001
CB650	JH2RC050*CM300001	VB44A	RC03E-2300001
CB650SC	JH2RC080*CM000001	VB44C	RC08E-2000001
CB750C	JH2RC011*CM200001	VB42A	RC01E-2300001
CB750F	JH2RC040*CM300001	VB42B	RC04E-2300001
CB750K	JH2RC010*CM300001	VB42A	RC01E-2300001
CB750SC	JH2RC012*CM000001	VB42A	RC01E-2000001
VF750C	JH2RC071*CM000001	VD51A	RC07E-4000001
VF750S	JH2RC070*CM000001	VD50A	RC07E-2000001
CB900C	JH2SC040*CC400001	VB43A	SC04E-2200001
CB900C	IHFSC040*CA200001		SC04E-2200001
CB900F	JH2SC010*CM100001	VB43C	SC01E-2300001
GL1100	JH2SC020*CC200001	VB48C	SC02E-2200001
GL1100	IHFSC020*CA200001		SC02E-2200001
GL1100A	JH2SC022*CC200001	VB48C	SC02E-2200001
GL1100A	IHFSC022*CA200001		SC02E-2200001
GL1100I	JH2SC021*CC200001	VB48C	SC02E-2200001
GL1100I	IHFSC021*CA200001		SC02E-2200001
CBX	JH2SC060*CC400001		SC03E-2400001

1981 HONDA MOTORCYCLES CONT'D

<u>MODEL</u>	<u>VIN NUMBER</u>	<u>CARB I.D.</u>	<u>ENGINE NUMBER</u>
CB650C	RC051*BM100001	VB44A	RC03E-2200001
CB650	RC050*BM200001	VB44A	RC03E-2200001
CB750F	RC040*BM200001	VB42B	RC04E-2200001
CB750K	RC010*BM200001	VB42A	RC01E-2200001
CB750C	RC011*BM100001	VB42A	RC01E-2200001
CB900F	SC010*BM000001	VB43C	SC01E-2200001
CB900C	SC040*BC100001	VB43A	SC04E-2100001
GL1100	SC020*BA100001	VB48A	SC02E-2100001
GL1100I	SC021*BA100001	VB48A	SC02E-2100001
CBX	SC060*BC300004	VB64A	SC03E-2300001

1980 HONDA MOTORCYCLES

<u>MODEL</u>	<u>VIN NUMBER</u>	<u>CARB I.D.</u>	<u>ENGINE NUMBER</u>
PA501I	PA50-3200001		PA50E-H1210066
NC50	NC50-2200001		NC50E-2200001
NA50	AB01-5100001		AB01E-5100001
Z50R	AB02-5100001		AB02E-5100001
ATC70	TB03-2000001		TB03E-2000001
CT70	CT70-5100001	PB37B	CT70E-5100001
XL80S	HD04-5000001		HD04E-5000001
XR80	HE01-5100001	PC10C	HE01E-5100001
CR80R	HE02-5000001	PE21A	HE02E-5000001
XL100S	HD01-5100001	PD30A	HD01E-5100001
CT110	JD01-5000001	PB21A	JD01E-5000001
ATC110	TB02-2000001		TB02E-2000001
CR125R	JE01-2100001	PE06B	JE01E-2100001
CB125S	JC04-5100001	PD24A	JC04E-5100001
XL125S	JD02-5000001	PD13A	JD02E-5000001
XL185S	MD02-5000001	PD13B	MD02E-5000001
ATC185	TB01-2000001		TB01E-2000001
XR200	ME02-5100001		ME02E-5100001
CM200T	MC01-2000001	PD23A	MC01E-2000001
XR250	ME01-5100001	PD12A	ME01E-5100001
FL250	TB04-2000001		TB04E-2000001
CR250R	ME03-2000001	PE01	ME03E-2000001
XL250S	MD01-5200001	PD10A	MD01E-5200001
CM400E	NC01-4000001	VB22A	NC01E-4000001
CM400T	NC01-2100001	VB22A	NC01E-2100001
CM400A	NC02-2100001	VB24C	NC02E-2100001
CB400T	NC03-2000001	VB22B	NC03E-2000001
CX500D	PC01-4100001	VB28A	PC01E-4100001
CX500C	PC01-2100001	VB25A	PC01E-2100001
XR500	PE01-5100001	PD11A	PE01E-5100001
XL500S	PD01-5100001	PD07B	PD01E-5100001
CB650C	RC05-2000001	PD50B	RC05E-2000001
CB750F	RC04-2100001	VB42A	RC04E-2100001
CB750K	RC01-2100001	VB42A	RC01E-2100001
CB750C	RC01-2200001	VB42A	RC01E-2100001
CB900C	SC04-2000001	VB43A	SC04E-2000001
GL1100	SC02-2000002	VB48A	SC02E-2000001
GL1101	SC02-4000001	VB48A	SC02E-2000001
CBX	SC03-2000001	VB62A	SC03E-2000001

1979 HONDA MOTORCYCLES

<u>MODEL</u>	<u>VIN NUMBER</u>	<u>CARB I.D.</u>	<u>ENGINE NUMBER</u>
PA50M	PA50M-2100001		PA50ME-J1
PA50	PA50-2200001	BB21A/BB20A	PA50E-H1
NC50	NC50-2100001	PA08B	NC50E-2100001
NA50	AB01-5000001	PA08B	AB01E-5000001
Z50R	AB02-5000001	PA03B	AB02E-5000001
ATC70	ATC70-2100001	PB38A	ATC70E-2100001
CT70	CT70-5000001	PB37A	CT70E-5000001
XL75	XL75-5000001	PC08E	XL75E-5000001
XR80	HE01-5000001	PC10B	HE01E-5000001
CT90	CT90-5000001	PB28A	CT90E-5000001
XL100S	HD01-5000001	PD20A	HD01E-5000001
ATC110	ATC110-2000001	PB20A	ATC110E-2000001
CR125R	JE01-2000001	PE05A	JE01E-2000001
CB125S	CB125S-5000001	PD68B	CB125SE-5000001
XL125S	L125S-5000001	PD14A	L125SE-5000001
CM185T	CM185T-2100001	PD98A	CM185TE-2100001
XR185	ME02-5000001	PD31A	ME02E-5000001
XL185S	XL185S-5000001	PD14B	XL185SE-5100001
XR250	ME01-5000001	PD02A	ME01E-5000001
FL250	FL250-2000001	092B	FL250E-2000001
CR250R	CR250R-2100001	PE01A	CR250E-2100001
XL250S	XL250S-5100001	PD03A	L250SE-5100001
CM400T	NC01-2000001	VB21C	NC01E-2000001
CM400A	NC02-2000001	VB24B	NC02E-2000001
CB400T I	CB400T-2100001	VB21B	CB400TE-2100001
CB400T II	CB400T-4100001	VB21B	CB400TE-4100001
CX500D	PC01-4000001	VB23A	PC01E-4000001
CX500C	PC01-2000001	VB27A	PC01E-2000001
CX500	CX500-2100001	VB26A	CX500E-2100001
XR500	PE01-5000001	PD06A	PE01E-5000001
XL500S	PD01-5000001	PD07A	PD01E-5000001
CB650	RC03-2000001	PD51A	RC03E-2000001
CB750F	RC04-2000001	VB42B	RC04E-2000001
CB750L	RC01-3000001	VB42B	RC01E-3000001
CB750K	RC01-2000001	VB42B	RC01E-2000001
GL1000	GL1-4100001	771A	GL1E-4100001
CBX	CB1-2100001	VB60A	CB1E-2100001

1978 HONDA MOTORCYCLES

<u>MODEL</u>	<u>VIN NUMBER</u>	<u>CARB I.D.</u>	<u>ENGINE NUMBER</u>
CT70	CT70-2700001	PB36A	CT70E-2700001
XL75	XL75-1100001	PC08E	XL75E-1100001
CT90	CT90-1900001	PB28A	CT90E-1900001
XL100	XL100-1400001	PB90D	XL100E-1400001
CB125S	CB125S-1500001	PB66B	CB125SE-1500001
XL125	XL125-2100001	PD65C	XL125E-2100001
CM185T	CM185T-2000001	PD98A	CM185T-2000001
XL250S	XL250S-5000013	PD03A	L250SE-5000013
CB400A	CB400A-2000001	VB24A	CB400AE-2000001
CB400T I	CB400T-2000001	VF21B	CB400TE-2000001
CB400T II	CB400T-4000032	VB21A	CB400TE-4000032
CX500	CX500-2000001	VB26A	CX500E-2000001
CB750A	CB750A-7200001	PD43A	B750AE-7200001
CB750F	CB750F-2200001	PD42A	CB750E-3100001
CB750K	CB750K-2800001	PD42B	CB750E-3000001
GL1000	GL1-4000001	769A/771A	GL1E-4000001

1968 - 1975 HONDA MOTORCYCLES CONT'D

<u>MODEL</u>	<u>CCs</u>	<u>FRAME NUMBER</u>	<u>ENGINE NUMBER</u>
CSA77	305	CSA77-	CSA77E-
CP77	305	CP77-	CP77E-
CA78	305	CA78-	CA78E-
ATC90 (K1 - K2)	90	ATC90-	ATC90E-
C90M	90	C90M-	C90ME-
CL90	90	CL90-	CL90E-
CL90L	90	CL90-	CL90E-
CT90 (K1 THRU K6)	90	CT90-	CT90E-
CT90P	90	CT90P-	CT90PE-
S90	90	S90	S90E-
SL90	90	SL90-	SL90E-
ST90 (K1 -K2)	90	ST90-	ST90E-
CM91*	90	CM91()	CM91()E-
CA92	125	CA92-	CA92E-
CB92	125	CB92-	CB92E-
CA95	150	CA95-	CA95E-
C100	50	C110-	C100E-
C100R*	50	C100R-	C100RE-
CA100	50	CA100-	CA100E-
CA100T	50	CA100T-	CA100TE-
CB100 (K1 THRU K3)	100	CB100-	CB100E-
CL100 (K1 THRU K3)	100	CL100-	CL100E-
CL100S (S2)	100	CL100S-	CL100SE-
SL100 (K1 THRU K3)	100	SL100-	SL100E-
XL100 (K1)	100	XL100-	XL100E-
C102	50	C102-	C102E-
CA102*	50	CA102-	CA102E-
C105T	55	C105T-	C105TE-
CA105	50	CA105-	CA105E-
CA105T*	55	CA105T()-	CA105T()3-
C110	50	C110-	C110E-

*May have an Alpha designator in frame number

1968 - 1975 HONDA MOTORCYCLES CONT'D

MODEL	CCs	FRAME	ENGINE
CB125S	125	CB125S-	CB125SE-
CB125S1(2)	125	CB125S-	CB125SE-
CL125*	125	CL125-	CL125E-
CL125S	125	CL125S-	CL125SE-
CL125S1	125	CL125S-	CL125SE-
CR125M	145	CR125M-	CR125ME-
MT125	125	MT125-	MT125SE-
SL125 (K1)	125	SL125-	SL125E-
SL125S	125	SL125S-	SL125SE-
SS125*	125	SS125()-	SS125()E-
TL125	125	TL125-	TL125E-
XL125 (K1)	125	XL125-	XL125E-
CA160	160	CA160-	CA160E-
CB160	160	CB160-	CB160E-
CL160	160	CL160-	CL160E-
CL160D	160	CL160-	CL160E-
CA175	175	CA175-	CA175E-
CB175 (K4 THRU K6)	175	CB175-	CB174E-
CL175 (K3 THRU K6)	175	CL175-	CL175E-
SL175 (K1)	175	SL175-	SL175E-
XL175 (K1)	175	XL175-	XL175E-
MR175	175	MR175-	MR175E-
C200	90	C200-	C200E-
CA200	90	CA200-	CA200E-
CB200	90	CB200-	CB200E-
CB200T	200	CB200-	CB2003-
CL200	200	CL200-	CL200E-
CT200	90	CT200-	CT200E-
CR250M	250	CR250M-	CR250ME-
MR250	250	MR250-	MR250E-
MT250	250	MT250-	MT250E-
SL250S	250	SL250S-	SL250SE-
TL250	250	TL250S-	TL250SE-
XL250	250	XL250-	XL250E-
CB350 (K20K3)	350	CB350-	CB350E-
CB350F	350	CB350F-	CB350FE-
CB350F1	350	CB350F-	CB350FE-

1968 - 1975 HONDA MOTORCYCLES CONT'D

<u>Model</u>	<u>CCs</u>	<u>Frame Number</u>	<u>Engine Number</u>
CB350G	350	CB350-	CB350E
CL350 (K1 THRU K3)	350	CL350-	CL350E-
SL350	350	SL350-	SL350E-
XL350	350	XL350-	XL350E-
CB360	360	CB360-	CB360E-
CB360G	360	CB360-	CB360E-
CB360T	360	CB360-	CB360E-
CL360 (K1)	360	CL360-	CL360E-
CB400F	400	CB400-	CB400E-
CB450 K1 THRU K7)	450	CB450-	CB450E-
CB450D	450	CB450-	CB450E-
CB450P	450	CB450-	CB450E-
CL450 (K1 THRU K6)	450	CL450-	CL450E-
CB500	500	CB500-	CB500E-
CB500	500	CB500-	CB500E-
CB550 (K1)	550	CB550-	CB550E-
CB550F	550	CB550-	CB550E-
CB750 (K1 THRU K6)	750	CB750-	CB750E-
CB750F	750	CB750-	CB750E-
CB750P	750	CB750-	CB750E-
GL1000	1000	GL1000-	GL1000E-

*May have an Alpha designator in frame number

1968 - 1975 HONDA MOTORCYCLES CONT'D

<u>MODEL DESIGNATION</u>	<u>YEAR MODEL</u>	<u>FIRST FRAME NUMBER</u>	<u>FIRST ENGINE NUMBER</u>	<u>ENGINE NUMBER LOCATION</u>
*XR75K2	1975	XR75-1200001	XR75E-1200001	LEFT SIDE
*XR75-76	1976	XR75-1300001	XR75E-1300001	LEFT SIDE
*XR75-77	1977	XR75-1400001	XR75E-1400001	LEFT SIDE
*XR75-78	1978	XR75-1500001	XR75E-1500001	LEFT SIDE
XL70	1974	XL70-1000001	XL70E-1000001	LEFT SIDE
XL70K1	1975	XL70-1100001	XL70E-1100001	LEFT SIDE
XL70-76	1976	XL70-1200001	XL70E-1200001	LEFT SIDE
C70	1981	DA010*BS100001	DA01E-2100001	LEFT SIDE
CT70K3	1974	CT70-2400001	CT70E-2400001	LEFT SIDE
CT70K4	1975	CT70-2400001	CT70E-2400001	LEFT SIDE
CT70-76	1976	CT70-2500001	CT70E-2500001	LEFT SIDE
CT70-77	1977	CT70-2600001	CT70E-2600001	LEFT SIDE
CT70-78	1978	CT70-2700001	CT70E-2700001	LEFT SIDE
CT70	1979	CT70-5000001	CT70E-5000001	LEFT SIDE
CT70	1980	CT70-5100001	CT70E-5100001	LEFT SIDE
CT70	1981	DD010*BS200001	DD01E-5200001	LEFT SIDE
*ATC70K1	1974	ATC70-1100001	ATC70E-1100001	LEFT SIDE
*ATC70-78	1978	ATC70-2000001	ATC70E-2000001	LEFT SIDE
*ATC70	1979	ATC70-2100001	ATC70E-2100001	LEFT SIDE
*ATC70	1980	TB03-2000001	TB03E-2000001	LEFT SIDE
*ATC70	1981	TB0300BC600001	TB03E-2600001	LEFT SIDE
*Z50AK5	1974	Z50A-5000001	Z50AE-5000001	LEFT SIDE
*Z50AK6	1975	Z50A-6000001	Z50AE-6000001	LEFT SIDE
*Z50A-76	1976	Z50A-6100001	Z50AE-6100001	LEFT SIDE
*Z50A-77	1977	Z50A-6200003	Z50AE-6114616	LEFT SIDE
*Z50A-78	1978	Z50A-6300001	Z50AE-6300001	LEFT SIDE
*Z50R	1979	AB02-5000001	AB02E-5000001	LEFT SIDE
Z50R	1980	AB02-5100001	AB02E-5100001	LEFT SIDE
*Z50R	1981	AB020*BS200001	AB02E-5200001	LEFT SIDE
*QA50K2	1974	QA50-3000001	QA50E-3000001	LEFT SIDE
*QA50K3	1975	QA50-4000001	QA50E-4000001	LEFT SIDE
*MR50	1974	MR50-1000001	MR50E-1000001	LEFT SIDE
*MR50K1	1975	MR50-2000001	MR50E-2000001	LEFT SIDE
NA50	1979	AB01-5000001	AB01E-5000001	RIGHT SIDE
NA50	1980	AB01-5100001	AB01E-5100001	RIGHT SIDE
NA50	1981	AB011*BS200001	AB01E-5200001	RIGHT SIDE
NX50	1981	AB040*BS000001	AB04E-2000001	RIGHT SIDE
NC50	1977	NC50-1100021	NC50E-1100021	RIGHT SIDE
NC50-78	1978	NC50-2000001	NC50E-2000001	RIGHT SIDE
NC50	1979	NC50-2100001	NC50E-2100001	RIGHT SIDE
NC50	1980	NC50-2200001	NC50E-2200001	RIGHT SIDE
NC50	1981	AB080*BS400001	AB08E-2400001	RIGHT SIDE

* Off Road Only
 ** Competition Only
 *** Mopeds

<u>MODEL DESIGNATION</u>	<u>YEAR MODEL</u>	<u>FIRST FRAME NUMBER</u>	<u>FIRST ENGINE NUMBER</u>	<u>ENGINE LOCATION ON CRANKCASE</u>
***PA50 (30MPH)	1978	PA50-1200001	PA50E-H1000001	RIGHT SIDE
***PA50	1979	PA50-2200001	PA50E-H1	RIGHT SIDE
***PA50M (20MPH)	1978	PA50M-1100001	PA50ME-J1000001	RIGHT SIDE
***PA50M	1979	PA50M-2100001	PA50ME-J1	RIGHT SIDE
***PA50II	1981	AB090*BB100001	AB09E-2000001	RIGHT SIDE
***PA50II	1980	PA50-3200001	PA50E-H1210066	RIGHT SIDE
CBX	1979	CB1-2100001	CB1E-2100001	TOP
CBX	1980	SC03-2000001	SC03E-2000001	TOP
CBX	1981	SC060*BC3000004	SC03E-2300001	TOP
GL1100I	1980	SC02-4000001	SC02E-2000001	TOP
GL1100I	1981	SC021*BA100001	SC02E-2100001	TOP
GL1100	1980	SC02-2000001	SC02E-2000001	TOP
GL1100	1981	SC020*BA100001	SC02E-2100001	TOP
GL1000	1975	GL1-1000001	GL1E-1000001	TOP
GL1000-76	1976	GL1-2000001	GL1E-2000001	TOP
GL1000-LTD	1976	GL1-2035001	GL1E-2033474	TOP
GL1000-77	1977	GL1-3000006	GL1E-3000006	TOP
GL1000-78	1978	GL1-4000001	GL1E-4000001	TOP
GL1000	1979	GL1-4100001	GL1E-4100001	TOP
CB900C	1980	SC04-2000001	SC04E-2000001	TOP
CB900C	1981	SC040*BC1000001	SC04E-2100001	TOP
CB900F	1981	SC010*BM0000001	SC01E-2200001	TOP
CB750C	1980	RC01-2200001	RC01E-2100001	TOP
CB750C	1981	RC011*BM1000001	RC01E-2200001	TOP
CB750K4	1974	CB750-2300001	CB750E-2300001	TOP
CB750K5	1975	CB750-2500001	CB750E-2368120	TOP
CB750K-76	1976	CB750-2540001	CB750E-2428768	TOP
CB750K-77	1977	CB750K-2700002	CB750E-2700001	TOP
CB750K-78	1978	CB750K-2800001	CB750E-3000001	TOP
CB750K	1979	RC01-2000001	RC01E-2000001	TOP
CB750K	1980	RC01-2100001	RC01E-2100001	TOP
CB750K	1981	RC010*BM2000001	RC01E-2200001	TOP
CB750L	1979	RC01-3000001	RC01E-3000001	TOP
CB750F	1975	CB750F-1000002	CB750FE-2500004	TOP
CB750F	1976	CB750F-2000001	CB750FE-2515094	TOP
CB750F-77	1977	CB750F-2100001	CB750FE-2600001	TOP
CB750F-78	1978	CB750F-2200001	CB759E-3100001	TOP
CB750F	1979	RC04-2000001	RC04E-2000001	TOP
CB750F	1980	RC04-2100001	RC04E-2100001	TOP
CB750F	1981	RC040*BM2000001	RC04E-2200001	TOP
CB750A-76	1976	CB750A-7000001	B750AE-7000001	TOP
CB750A-77	1977	CB750A-7100001	B750AE-7100001	TOP
CB750A-78	1978	CB750A-7200001	B750AE-7200001	TOP
CB650	1979	RC03-2000001	RC03E-2000001	TOP
CB650	1980	RC05-2100001	RC03E-2100001	TOP
CB650	1981	RC050*BM2000001	RC03E-2200001	TOP

<u>MODEL DESIGNATOR</u>	<u>YEAR MODEL</u>	<u>FIRST FRAME NUMBER (VIN)</u>	<u>FIRST ENGINE NUMBER</u>	<u>ENGINE NUMBER ON CRANKCASE</u>
CB650C	1980	RC05-2000001	RC03E-2100001	TOP
CB659C	1981	RC051*BM100001	RC03E-2200001	TOP
CB550	1974	CB550-1000001	CB550E-1000001	TOP
CB550K1	1975	CB550-1200001	CB550E-1200001	TOP
CB550K-76	1976	CB550-1230001	CB550E-1067337	TOP
CB550K-77	1977	CB550K-2000005	CB550E-2000001	TOP
CB550K-78	1978	CB550K-2100001	CB550E-2100001	TOP
CB550F	1975	CB550F-1000002	CB550E-1100004	TOP
CB550F-76	1976	CB550F-2000001	CB550E-1109887	TOP
CB550F-77	1977	CB550F-2100001	CB550E-1135380	TOP
GL5001	1981	PC021*BM000001	PC02E-2000001	LEFT SIDE
GL500	1981	PC020*BM000001	PC02E-2000001	LEFT SIDE
XL500S	1979	PD01-5000001	PD01E-5000001	TOP
XL500S	1980	PD01-5100001	PD01E-5100001	TOP
XL500S	1981	PD010*BM200001	PD01E-5200001	TOP
*XR500	1979	PE01-5000001	PE01E-5000001	TOP
*XR500	1980	PE01-5100001	PE01E-5100001	TOP
*XR500R	1981	PE010*BM200001	PE01E-5200001	TOP
CB500T	1975	CB500T-1000001	CB500TE-1000001	TOP
CB500T	1976	CB500T-2000001	CB500TE-2000001	TOP
CX500-78	1978	CX500-2000001	CX500E-2000001	LEFT SIDE
CX500	1979	CX500-2100001	CX500E-2100001	LEFT SIDE
CX500 CUSTOM	1979	PC01-2000001	PC01E-2000001	LEFT SIDE
CX500C	1980	PC01-2100001	PC01E-2100001	LEFT SIDE
CX500C	1981	PC010*BM200001	PC01E-2200001	LEFT SIDE
CX500 DELUXE	1979	PC01-4000001	PC01E-4000001	LEFT SIDE
CX500D	1980	PC01-4100001	PC01E-4100001	LEFT SIDE
CX500D	1981	PC011*BM200001	PC01E-4100001	LEFT SIDE
CR450R	1981	PE022*BM000001	PE02E-5000001	LEFT SIDE
CB400F	1975	CB400F-1000001	CB400FE-1000001	TOP
CB400F-76	1976	CB400F-2000001	CB400FE-2000001	TOP
CB400F-77	1977	CB400F-2100001	CB400FE-2100001	TOP
CB400T-11	1978	CB400T-4000032	CB400TE-4000032	TOP
CB400T-11	1979	CB400T-4100001	CB400TE-4100001	TOP
CB400T-1	1978	CB400T-2000001	CB400TE-2000001	TOP
CB400T-1	1979	CB400T-2100001	CB400TE-2100001	TOP
CB400T	1980	NC03-2000001	NC03E-2000001	TOP
CB400T	1981	NC030*BM100001	NC03E-2100001	TOP
CB400A	1978	CB400A-2000001	CB400AE-2000001	TOP
CM400A	1979	NC02-2000001	NC02E-2000001	TOP

<u>MODEL DESIGNATOR</u>	<u>YEAR MODEL</u>	<u>FIRST FRAME NUMBER (VIN)</u>	<u>FIRST ENGINE NUMBER</u>	<u>ENGINE NUMBER ON CRANKCASE</u>
CM400A	1980	NC02-2100001	NC02E-2100001	TOP
CM400A	1981	NC020*BM200001	NC02E-2200001	TOP
CM400C	1981	NC012*BM000001	NC01E-2200001	TOP
CM400T	1979	NC01-20000001	NC01E-2000001	TOP
CM400T	1980	NC01-2100001	NC01E-2100001	TOP
CM400T	1981	NC010*BM200001	NC01E-2200001	TOP
CM400E	1980	NC01-4000001	NC01E-4000001	TOP
CM400E	1981	NC011*BM100001	NC01E-4100001	TOP
CB360	1974	CB360-1000001	CB360E-100000	TOP
CB360G	1974	CB360-1000001	CB350E-100000	TOP
CB360T	1975	CB360-2000001	CB360E-200000	TOP
		or	or	
CB360T	1976	CB360-2100001	CB3603-2100001	TOP
CB360T	1976	CB360-2200001	CB360E-2200001	TOP
CL360	1974	CL360-1000001	CL360E-1000001	TOP
CL360K1	1975	CL360-2000001	CL360E-2000001	TOP
CJ360-76	1976	CJ360-2000001	CJ360TE-2000003	TOP
CJ360-77	1977	CJ360-2100001	CJ360TE-2100001	TOP
XL350	1974	XL350-1000001	XL350E-1000001	TOP
XL350K1	1975	XL350-2000001	XL350E-2000001	TOP
XL350-76	1976	XL350-3000001	XL350E-3000001	TOP
XL350-77	1977	XL350-3100001	XL350E-3100001	TOP
XL350-78	1978	XL350-3200001	XL350E-3200001	TOP
ATC250R	1981	TB0600BC000001	TB06E-2000001	RIGHT SIDE
ATC250K1	1974	XL250-2000001	SL250SE-2000001	TOP
XL250K2	1975	XL250-3000001	SL250SE-3000001	TOP
XL250-76	1976	XL250-4000001	L250SE-1000001	TOP
XL250S-78	1978	XL250S-5000013	L250SE-5000013	TOP
XL250S	1979	XL250S-5100001	L250SE-5100001	TOP
XL250S	1980	MD01-5200001	MD01E-5200001	TOP
XL250S	1981	MD010*BM300001	MD01E-5300001	TOP
MT250	1974	MT250-1000001	MT250E-1000001	TOP
MT250K1	1975	MT250-2000001	MT250E-2000001	TOP
MT250-76	1976	MT250-3000001	MT250E-3000001	TOP
*TL250	1975	TL250-1000001	TL250E-1000001	TOP
*TL250-76	1976	TL250-2000001	TL250E-2000001	TOP
*CR250M1	1975	CR250M-2000001	CR250ME-2000001	TOP
*CR250-76	1976	CR250M-3000001	CR250ME-3000001	TOP
**CR250R-78	1978	CR250R-2000001	CR250RE-1000001	TOP
**CR250R	1979	CR250R-2100001	CR250RE-2100001	TOP
**CR250R	1980	ME03-2000001	ME03E-2000001	TOP
**CR250R	1981	ME030*BC300001	ME03E-2300001	TOP
*MR250-76	1976	MR250-1000001	MR250E-1000001	TOP
*FL250	1977	FL250-1000001	FL250E-1000001	REAR
*FL250-78	1978	FL250-1100001	FL250E-1012006	REAR
*FL250	1979	FL250-2000001	FL250E-2000001	REAR
*FL250	1980	TB04-2000001	TB04E-2000001	REAR

<u>MODEL DESIGNATOR</u>	<u>YEAR MODEL</u>	<u>FIRST FRAME NUMBER (VIN)</u>	<u>FIRST ENGINE NUMBER</u>	<u>ENGINE NUMBER LOCATION ON CRANKCASE</u>
*FL250	1981	TB0400BC400001	TB04E-2400001	REAR
*XR250	1979	ME01-5000001	ME01E-5000001	TOP
*XR250	1980	ME01-5100001	ME01E-5100001	TOP
*XR250R	1981	ME010*BM200001	ME01E-5200001	TOP
*ATC200	1981	TB0500BC000001	TB05E-2000001	TOP
CB200	1974	CB200-1000001	CB200E-1000001	TOP
CD200T	1975	CB200-2000001	CB200E-2000001	TOP
CB200T-76	1976	CB200-2100001	CB200E-2100001	TOP
CL200	1974	CL200-1000001	CL200E-1000001	TOP
CM200T	1980	MC01-2000001	MC01E-2000001	LEFT SIDE
CM200T	1981	MC010*BM100001	MC01E-2100001	LEFT SIDE
*XR200	1980	ME02-5100001	ME02E-5100001	LEFT SIDE
*XR200	1981	ME020*BM200001	ME02E-5200001	LEFT SIDE
*XR200R	1981	ME040*BK000001	ME04E-5000001	LEFT SIDE
*ATC185	1980	TB01-2000001	TB01E-2000001	LEFT SIDE
*ATC185S	1981	TB0100BC100001	TB01E-2100001	LEFT SIDE
XL185S	1979	XL185S-5000001	XL185SE-5100001	LEFT SIDE
XL185S	1980	MD02-5000001	MD02E-5000001	LEFT SIDE
XL185S	1981	MD020*BK200001	MD02E-5200001	LEFT SIDE
*XR185	1979	ME02-5000001	ME02E-5000001	LEFT SIDE
CM185ST-78	1978	CM185T-2000001	CM185TE-2000001	LEFT SIDE
CM185ST	1979	CM185T-2100001	CM185TE-2100001	LEFT SIDE
XL175K1	1974	XL175-2000001	XL175E-2000001	TOP
XL175K2	1975	XL175-3000001	XL175E-3000001	TOP
XL175-76	1976	XL175-4000001	XL175E-4000001	TOP
XL175-77	1977	XL175-4100001	XL175E-4100001	TOP
XL175-78	1978	XL175-4200001	XL175E-4200001	TOP
*MR175	1975	MR175-1000001	MR175E-1000001	TOP
*MR175-76	1976	MR175-2000001	MR175E-2000001	TOP
*MR175-77	1977	MR175-2100001	MR175E-2100001	TOP
CB175K7	1974	CB175-8000001	CB175E-8000001	TOP
CL175K7	1974	CL175-8000001	CL175E-8000001	TOP
MT125	1974	MT125-1000001	MT125E-1000001	TOP
MT125	1975	MT125-2000001	MT125E-2000001	TOP
MT125	1976	MT125-3000001	MT125E-3000001	TOP
**MT125R-78	1978	MT125R2F-1081	MT125R2E-1081	TOP
XL125	1974	XL125-1000001	XL125SE-1000001	LEFT SIDE
XL125R1	1975	XL125-110001	XL125E-1100001	LEFT SIDE

* Off Road Only

** Competition

<u>MODEL DESIGNATOR</u>	<u>YEAR MODEL</u>	<u>FIRST FRAME NUMBER (VIN)</u>	<u>FIRST ENGINE NUMBER</u>	<u>ENGINE NUMBER LOCATION ON CRANKCASE</u>
MT125-76	1976	MT125-3000001	MT125E-3000001	TOP
MT125-76	1976	MT125-3000001	MT125E-3000001	TOP
***MT125R-78	1978	MT125R2F-1081	MT125R2E-1081	TOP
XL125	1974	XL125-1000001	XL125SE-1000001	LEFT SIDE
XL125K1	1975	XL125-1100001	XL125E-1100001	LEFT SIDE
XL125-76	1976	XL125-1200001	XL125E-1200001	LEFT SIDE
XL125-77	1977	XL125-2000005	XL125E-2000005	LEFT SIDE
XL125-78	1978	XL125-2100001	XL125E-2100001	LEFT SIDE
XL125S	1979	L125S-5000001	L125SE-5000001	LEFT SIDE
XL125S	1980	JD02-5000001	JD02E-5000001	LEFT SIDE
XL125S	1981	JD020*BK200001	JD02E-5200001	LEFT SIDE
CB125S1	1974	CB125S-1100001	CB125SE-1100001	LEFT SIDE
CB125S2	1975	CB125S-1200001	CB125SE-1200001	LEFT SIDE
CB125S-76	1976	CB125S-1300001	CB125SE-1300001	LEFT SIDE
CB125S-78	1978	CB125S-1500001	CB125SE-1500001	LEFT SIDE
CB125S	1979	CB125S-5000001	CB125SE-5000001	LEFT SIDE
CB125S	1980	JC04-5100001	JC04E-5100001	LEFT SIDE
CB125S	1981	JC040*BK700001	JC04E-2700001	LEFT SIDE
**CR125M	1974	CR125M-1000001	CR125ME-1000001	TOP
***CR125M1	1975	CR125M-2000001	CR125ME-2000001	TOP
*CR125M076	1976	CR125M-3000001	CR125ME-3000001	TOP
*CR125M-77	1977	CR125M-3100001	CR125ME-3100001	TOP
*CR125M-78	1978	CR125M-3200001	CR125ME-3200001	TOP
**CR125R	1979	JE01-2000001	JE01E-2000001	TOP
CR125R	1980	JE01-2100001	JE01E-2100001	TOP
CR125R	1981	JE010*BC200001	JE01E-2200001	TOP
*TL125K1	1974	TL125-1100001	TL125E-1100001	LEFT SIDE
*TL125K2	1975	TL125-1200001	TL125E-1200001	LEFT SIDE
*TL125-76	1976	TL125S-1000001	TL125SE-1000001	LEFT SIDE
CL125S1	1974	CL125S-1200001	CL125SE-1200001	LEFT SIDE
CT 125	1977	CT125-1010051	CT125E-1010051	LEFT SIDE
*ATC110	1979	ATC110-2000001	ATC110E-2000001	LEFT SIDE
ATX110	1980	TB02-2000001	TB02E-2000001	LEFT SIDE
*ATC110	1981	TB0200BC200001	TB02E-2200001	LEFT SIDE
CT110	1980	JD01-5000001	JD01E-5000001	LEFT SIDE
CT110	1981	JD010*BS100001	JD01E-5100001	LEFT SIDE
XL100	1974	XL100-1000001	XL100E-1000001	LEFT SIDE
XL100K1	1975	XL100-1100001	XL100E-1100001	LEFT SIDE

* Off Road Only

** Competition

<u>MODEL DESIGNATOR</u>	<u>YEAR MODEL</u>	<u>FIRST FRAME NUMBER (VIN)</u>	<u>FIRST ENGINE NUMBER</u>	<u>ENGINE NUMBER LOCATION</u> <u>ON CRANKCASE</u>
XL100-76	1976	XL100-1200001	XL100E-1200001	LEFT SIDE
XL100-77	1977	XL100-1300001	XL100E-1300001	LEFT SIDE
XL100-78	1978	XL100-1400001	XL100E-1400001	LEFT SIDE
XL100S	1979	HD01-5000001	HD01E-5000001	LEFT SIDE
XL100S	1980	HD01-5100001	HD01E-5100001	LEFT SIDE
XL100S	1981	HD050*BK000001	HD05E-5000001	LEFT SIDE
*XR100	1981	HE030*BK000001	HE03E-5000001	LEFT SIDE
CT90K5	1974	CT90-1500001	CT90E-1500001	LEFT SIDE
CT90K6	1975	CT90-1600001	CT90E-1600001	LEFT SIDE
		or	CT90-1620001	or
			CT90E-1620001	LEFT SIDE
CT90-76	1976	CT90-1700001	CT90E-1700001	LEFT SIDE
CT90-77	1977	CT90-1800001	CT90E-1800001	LEFT SIDE
CT90-78	1978	CT90-1900001	CT90E-1900001	LEFT SIDE
CT90	1979	CT90-5000001	CT90E-5000001	LEFT SIDE
*ATC90K2	1974	ATC90-1300001	ATC90E-1300001	LEFT SIDE
*ATC90K3	1975	ATC90-1400001	ATC90E-1400001	LEFT SIDE
*ATC90-76	1976	ATC90-1500001	ATC90E-1500001	LEFT SIDE
*ATC90-77	1977	ATC90-1600001	ATC90E-1600001	LEFT SIDE
*ATC90-78	1978	ATC90-1700001	ATC90E-1700001	LEFT SIDE
ST90K1	1974	ST90-1100001	ST90E-1100001	LEFT SIDE
ST90K2	1975	ST90-1200001	ST90E-1200001	LEFT SIDE
**CR90R	1980	HE02-5000001	HE02E-5000001	LEFT SIDE
**CR80R	1981	HE020*BK100001	HE02E-5100001	LEFT SIDE
*XR80	1979	HE01-5000001	HE01E-5000001	LEFT SIDE
*XR80	1980	HE01-5100001	HE01E-5100001	LEFT SIDE
*XR80	1981	HE010*BK200001	HE01E-5200001	LEFT SIDE
XL89S	1980	HD04-5000001	HD04E-5000001	LEFT SIDE
XL80S	1981	HD040*BL100001	HD04E-5100001	LEFT SIDE
XL75-77	1977	XL75-1000001	XL75E-1000001	LEFT SIDE
XL75-78	1978	XL75-1100001	XL75E-1100001	LEFT SIDE
XL75	1979	XL75-5000001	XL75E-5000001	LEFT SIDE
*XR75K1	1974	XR75-1100001	XR75E-1100001	LEFT SIDE

*Off Road Only

*Competition Only

EXAMPLES OF SERIAL NUMBER STAMPINGS:

FRAME SERIAL NUMBER



FRAME SERIAL NUMBER



ENGINE SERIAL NUMBER



ENGINE SERIAL NUMBER



AMERICAN HONDA MOTOR CO., INC.
MOTORCYCLE SERVICE DEPARTMENT

HUSQVARNA

Husqvarna motorcycles are built in Sweden. They are imported into the U.S. as trail, dirt, enduro and moto cross machines.

VIN SYSTEM:

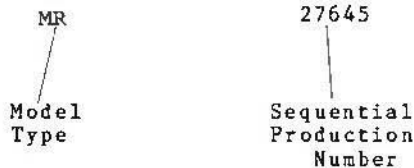

Husqvarna is currently producing the following models:

125XC - T	500CR - MX
125CR - MX	500XC - T
250CR - E	500AE - E
250XC - MX	500TX -MX
250WR - T	510TX - T
250WRX - E	510TE - E
400WR - E	

Note: T=Trail, MX=Moto cross, E-Enduro

VIN Location - On right side of steering head.

Engine Number- Located on right side of engine. Engine number and VIN are not the same. First four digits indicate the model:

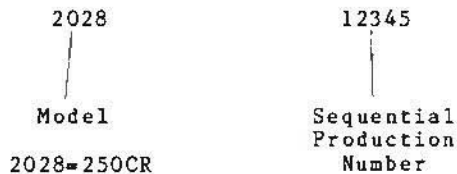

INDIAN

Indian Motorcycle Company of Taiwan now builds only ATV's and Mopeds. From 1970-1976, the Indian motorcycle was assembled in Taiwan from parts made in Japan, Italy and Taiwan. From 1909-1953, the Indian motorcycle was built in the United States.

The following information relates only to the Indian motorcycle.

VIN SYSTEM:



Model Number

13=MX 76B (75CC)
15=MX 80
16=MX74B (75CC)
20=ME-100A
22=MT-100
23=ML-100
30=ME-125

Phase Number - Used when a new designed part is used on motorcycle.

Production Year -
4=1974
5=1975
6=1976-etc.

Production Month -
A=January
B=February
C=March etc.

Production number will be the engine serial number of the motorcycle.

VIN System Cont'd

VIN Location - Stamped into headstock

Engine Number Location - Taiwan built - underneath air cleaner. Japan built under kick starter lever.

VIN SYSTEM: (U.S. Produced 1909-1953)

<u>348</u> 1948 year Model 2nd and 3rd digit indicates year built	<u>196</u> Sequential Production Number
---	---

Engine Number

<u>CDH</u> 74C1 "Chief"	<u>136</u> Sequential Production Number
------------------------------------	---

VIN Location - Serial number is stamped on face of left rear fork end.

Engine Number - On left side of crankcase under front cylinder on twin cylinder models. On the Indian "4", the engine number is stamped on transmission case near the shifter shaft lever. Engine and serial numbers are not the same.

Vehicles produced:

Indian 35	- 2 cylinders
Indian 45	- 2 cylinders
Indian 74	- 2 cylinders
Indian 4	- 4 cylinders
Dispatch Tow	- 2 cylinders

JAWA/CZ

The Jawa is manufactured at Strakonice, Czechoslovakia. The vehicles now imported are mopeds or racers. Street machines were last imported in 1979.

VIN SYSTEM:

<u>590</u>	.	<u>0</u>	.	<u>07631</u>
Model Number				Sequential Production Number

VIN Location - On plate riveted to headstock.

Engine Number - Stamped into crankcase, top side, right. Engine and serial numbers are not the same.

KAWASAKI

Kawasaki motorcycles are currently being produced in Akasaki, Japan and Lincoln, Nebraska, USA. These popular machines rank number two in theft preference in the State of California with 3,744 outstanding in 1985. This is not remarkable however, when one considers that during the first quarter of 1985 Kawasaki, made up 10.27% of new registrations in the U.S. (Source - R.L. Polk and Co., Detroit.)

In the United States, information on these vehicles may be obtained through Kawasaki Motors Corporation, USA, P.O. Box 25252, Santa Ana, California, 92799-5252.

VIN SYSTEM:

Kawasaki motorcycles follow the 17 digit VIN system. The full VIN is stamped on the headstock and is repeated on the Federal Certification label. On off road motorcycles, the 17 digit VIN is stamped but there will be no Federal Certification label.

Beginning on August 18, 1980, Kawasaki began to apply the 17 digit VIN to all models. During early 1981, a miscalculation was made because of using an incorrect code and 3,136 model KZ440A2 and KZ440D2 motorcycles with a "B" assembly plant code were stamped with incorrect check digits. These vehicles are:

Model KZ440D - Beginning VIN JKAKZHA1BB500001
Ending VIN-JKAKZHA1BB501608

Model KZ440d - Beginning VIN JKAKZHD1BB500001
Ending VIN-JKAKZHD1BB501528

VIN SYSTEM:

1981-1986

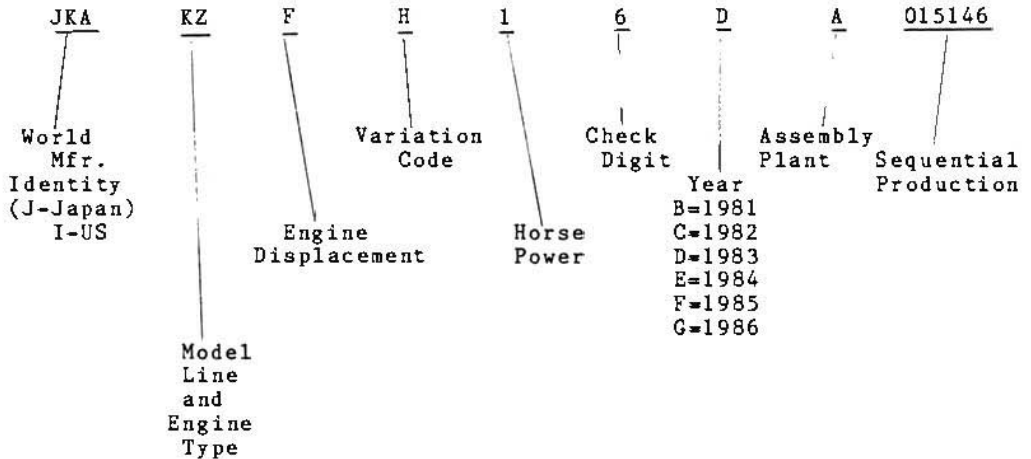

Model Line and Engine Type

- EN = 4 Stroke Street, in line Twin, Easy Riding
- EX = 4 Stroke Street, in line Twin, Super Sports
- KD = 2 Stroke Sport (off road only)
- KDX = 2 Stroke Enduro (off road only)
- KE = 2 Stroke Dual Purpose
- KH = 2 Stroke Street
- KL = 4 Stroke Dual Purpose
- KLF = 4 Wheel all Terrain Vehicale (off road only)
- KLT = 3 Wheel all Terrain Vehicle (off road only)
- KLX = 4 Stroke Enduro (off road only)
- KM = Mini Cycle (street legal)
- KT = Trials
- KV = Recreation vehicle
- KX = Motocross
- KXT = 3 Wheel all Terrain Vehicle Sport (off road only)
- KZ = 4 stroke street
- VN = 4 stroke street V-Twin, Easy Riding
- ZL = 4 stroke street, in line Multi, American Sports
- ZN = 4 stroke street, in line Multi, Easy Riding
- ZX = 4 stroke street, in line Multi, Super Sports

VIN System Cont'd

Engine Displacement

A = 1300cc
B = 1100cc
C = 1000cc
D = 750cc
E = 650cc
F = 550cc
H = 440cc
J = 420cc
K = 400cc
L = 305cc
M = 250cc
N = 200cc
P = 175cc
R = 125cc
T = 100cc
U = 80cc

Variation Code

(Various Alpha characters)

Assembly Plant

A=Akashi, Japan
B=Lincoln, Nebraska,USA

VIN System prior to 1981

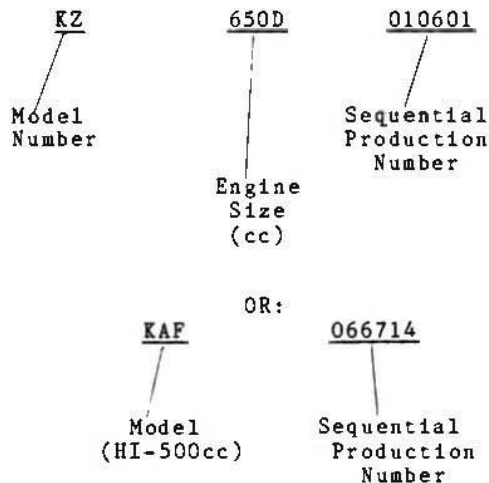

VIN System Cont'd

VIN Location - Stamped into headstock on right side. The Federal Certification label is to the left of the stamped number.

On some earlier models, this number was stamped on the left side of the headstock. Also on some early model machines, the number was stamped on the left side or right side panel, near the top of the shock absorber mount or the lower portion near the engine.

Engine Numbers - Engine numbers consist of a model code and sequential number. Engine numbers always contain the letter "E". While engine numbers bear some resemblance to frame numbers, they are not the same.

KZY00E

Model

E

"E"
for
Engine

002046

Sequential
Production
Number

Earlier model engine numbers might appear as:

KA

Model

E

"E"
Engine

006312

Sequential
Production
Number

Engine Number Locations: Stamped into boss located on top of engine case. On earlier models, this number was stamped on the top right side of the engine case or the top left side of the case.

The following chart lists the location of engine and frame numbers from 1965-1975

<u>MODEL</u>	<u>CC DISPLACEMENT</u>	<u>LOCATION OF ENGINE NUMBER</u>	<u>LOCATION OF FRAME NUMBER</u>
A1	250	L	left side of
A1SS	250	L	upper
A7	350	L	steering
A7SS	350	L	headstock
B53	50	R	on all
B55K	50	R	models
B8	125	R	
B8M	125	R	
B8S	150	R	
B8T	125	R	
C2SS	120	L	
C2TR	120	L	
D1	100	R	
F1	175	R	
F1TR	175	R	
F2	175	L	
F2TR	175	L	
F3	175	L	
F4	250	L	
F5	350	L	
F6	125	L	
F7	175	L	
F8	250	L	
F9	350	L	
F11	250	R	
C3SS	90	L	
G3TR	90	L	
G4TR	100	L	
G5	100	L	
H1	500	R	
H2	750	R	
J1	85	L	
J1T	85	L	
J1L	85	L	
J1TL	85	L	
J1TRL	85	L	
KD80	85	L	
KD125	125	L	
KS125	125	L	

Location of Engine and Frame numbers from 1965-1975 Cont'd

<u>MODEL</u>	<u>CC DISPLACEMENT</u>	<u>LOCATION OF ENGINE NUMBER</u>	<u>LOCATION OF FRAME NUMBER</u>
K2400S	400	L	Left side
K2400D	400	L	of upper
M10	50	R	steering
M11	55	R	headstock
MC1	90	L	all models
MC1M	90	L	
MT1	75	R	
S1	250	R	
S2	350	R	
S3	400	R	
SG-SGT	250	R	
W1	650	L	
W1SS	650	L	
Z1	900	R	

*L = Left side of engine case
 R = Right side of engine case

Following is a chart listing various models with engine and frame pre-fixes and their beginning and ending sequential numbers;

1969 - 1980

<u>MODEL</u>	<u>YEAR</u>	<u>FRAME</u>	<u>ENGINE</u>
H1 500cc	1969	KAF-000001-006726	KAE-00001-006314
H1 500cc	1970	KAF-006727-023300	KAE-006315-021812
H1A 500cc	1971	KAF-023676-047862	KAE-027876-043900
H1B 500cc	1972	KAF-047863-065512	KAE-054101-070023
H1C 500cc	1972	KAF-048664-049664	KAE-043902-045902
H1D 500cc	1973	H1F-000001-016999	KAE-070024-086999
H1E 500cc	1974	H1F-017001	KAE-087001
H2 750cc	1972	H2F-000001-020158	HS2-000001-023157
H2A 750cc	1973	H2F-023671-032199	H2E-023846-032399
H2B 750 cc	1974	H2F-032201	H2E032401
KS125 125cc	1974	K1-000001	K1E-000001
KX125cc	1974	K1-900001	K1E-900001
KX250 250cc	1974	K2-900001	K2E-900001
KX450 450cc	1974	K5-000001	K5E-000001
KZ400 40cc	1974	K4-000001	K4E-000001
MC1 90cc	1973	MC-000001-006945	MCE-000001-006965
MC1A 90cc	1974	MC-006946	MCE-006966
MC1M 90cc	1974	MC-500001	MCE-500001
MT1 75cc	1971	MT-000001-015072	MTE-000001-014252
MT1 75cc	1972	MT-015073-018924	MTE-014253-018118
MT1A 75cc	1973	MT-018925-029587	MTE-018119-029089
MT1B 75cc	1974	MT-029588	MTE-029090
S1 250cc	1972	S1F-000001-004090	S1E-000001-004593
S1A 250cc	1973	S1F-004691-011999	S1E-004594-011999
S1B 250cc	1974	S1F-012001	S1E-012001
S2 350cc	1972	S2F-003700-028630	S2E-003700-028225
S2A 350cc	1973	S2T-000001-015683	S2E-028226-044371
S3 400cc	1974	S3F-000001	S3E-000001

KAWASARI 1980

<u>MODEL</u>	<u>FRAME</u>	<u>ENGINE</u>
KX080A	KX080A012501	KX080AEO11201
KD080M1	KD080M000001	KD080ME000001
KD80A1	DX080A000001	DX080AE000001
KE100A9	G5134101	G5E134801
KE125A7	K1081601	R1E082101
KDX175A1	DX175A000101	KX175AE000101
KE175D2	RE175D0000601	RE175DE000601
KDX250A1	DX250A500001	DX250AE00001
KLX250A2	LX250A004101	LX250AE004101
KDX400A2	DX400A502325	DX400AE002501
KM100A6	KM100A024801	KM100AE024801
K2250D1	K2250D000001	K2250DE000001
KL250A3	KL250A017301	KL250AE017301
KX125A6	KX125A005101	KX125AE005101
KX250A6	KX250A500001	KX250AE005601
KX420A1	KX420A50001	KX420AE000001
KZ440B1	KZ440B000001	KZ440AE000001
KZ440A1	KZ440D000001	KZ440DE000001
KZ440D1	KZ440A000001	KZ440AE000001
K2550A1	K2550A000001	K2550AE000001
K2650F1	K2650F000001	K2650BE114501
K2650E1	K2650E000001	K2650E000001
K2750E	K2750E000001	K2750EE000001
K2750G1	K2750G000001	K2750BE046201
KZ1000B4	KZT00B523544	KZT00AE092601
KZ1000C3	KZT00C502517	
KZ1000E1	KZT00E010001	KZT00EE010001
KZ1000D3	KZT00D017801	KZT00DE017616
KZ1300A2	KZT30A006201	KZT30AE005801

KAWASAKI 1979

<u>MODEL</u>	<u>FRAME</u>	<u>ENGINE</u>
KX80A1	KX080A000101-012185	KX080AE000101-011123
KD100M4	KD100M019101-027150	KD100ME019101-027150
KE100A8	G5126001-134004	G5E126001-134477
KD125A5	K1511201-514250	K1E511201-514250
KE125A6	K1074101	K1E074101
KD175A4	KD175A008501-010500	KD175AE008501-010500
KE250B3	KE250B008501-010700	KE250BE008501-010702
KL250A1	LX250A000101-004080	LX250AE000101004085
KDX400A1	DX400A500001-502321	DX400AF000101-002426
KM100A4	KM100A091201-024751	KM100AE019201-024757
KZ200A2	KZ200A026501	KZ200AE026501
KL250A2	KL250A011201	KL250AE011201
KX125A5	KX125A001701-005000	KX125AE0017-1005014
KX250A5	KX250A001801-005500	KX250AE001801-005515
KZ400B2	K4099501-114107	K4E139801-161618
KZ400H1	KZ400H000101	K4E139801
KZ650B3	KZ650B046201	KZ650BE092001
KZ650BE	KZ650B523524	KZ650BE092001
KZ650C3	KZ650C022801	KZ650BE092001
KZ650D2	KZ650D01601	KZ650DE010601
KZ750B4	KZ750B033101-046100	KZ750BE033101-046086
KZ1000A3A	KZT00A038430-04275S	KZT00AE081569-092353
KZ1000A3A	KZT00A519538	KZT00AE08150090730
KZ1000B3	KZT00B515537	KZT00AE081569090720
KZ1000E1	KZT00E000501-009445	KZT00EE000101-009461
KZ1300A1	KZT30A000101-005618	KZT3019E000101-005039

KAWASAKI 1978

<u>MODEL</u>	<u>FRAME</u>	<u>ENGINE</u>
KD100ME	KD100M012601-019001	KD100ME012601-019003
KE100A7	G5114201-125918	G5E113701-125420
KD125A4	K1508901-511151	K1E508901-511154
KE125A5	K1060501-073240	K1E060701-073945
KD175AE	KD175A006001-008400	KD175AE006001008400
KE175B3	KE175B021001-035710	KE175BE021001037745
KE250B2	KE250B003891-008390	KE250BE003925-008456
KM100A3	KM100A011101-015237	KM100A3011101-015241
KM100A3	KM100A-016238-019200	KM100AE016242-019200
KZ200	KZ200A-000101-023631	KZ200AE000101-023721
KL250A1	KL250A001001-010900	KL250AE001001-010935
KX125A4	KX125A000001-001633	KX125AE000001-001640
KX250A4	KX250A000001-001717	KX250AE000001-001724
KZ400A2	KZ400A503006-505008	K4E106839111932
KZ400C1	K4S24701-28165	K4SE003701-037169
KZ400B1	K4077801-097813	K4E118001-138024
KZ650B2	KZ650B027501-032200	KZ650B508016-515325
KZ650B2A	KZ650B033551-044828	KZ650BE061299-090685
KZ650B2A	KZ650B515326-523523	KZ650BE061299-092000
KZ650C2	KZ650C010001-022185	KZ650BE046001-091580
KZ650D1	KZ650D000001-003340	KZ650DE000101-003467
KZ650D1A	KZ6500003793-010292	KZ650DE003781-010308
KZ750B3	KZ750B025701-033033	KZ750BE025701-033074
KZ1000B2	KZT008507531-515536	KZT00AE058797-075473
KZ1000A2A	KZT00A515035-519537	KZT00AE057037057066
KZ1000A2A	KZT00A034226-515034	KZT00AE057037-057066
KZ10000A2	KZT00A507027-515034	KZT00AE042501-058140
KZ10000D1	KZTD000101-017392	KZT00DE000101-017412

KAWASAKI 1977

<u>MODEL</u>	<u>FRAME</u>	<u>ENGINE</u>
KH100B8	GA372501-373435	G7E568079-569063
KD100M2	KD100M005001-12506	KD100ME005001-12509
KE100A6	G5105524-113723	G5E105524-113221
KD125A3	K1506301-508800	K1E506301-598802
KE125A4	K1048101-059910	K1E048101-060188
KD175A2	KD175A003601-005906	KD175AE003601-005906
KE175B2	KE175B011101-020909	KE175BE011101-020919
KE250B1	KE250B000101-003890	KE250BE000101003924
KM100A2	KM100A007001-011013	KM100AF007001-011092
K2400A1	K2400A500001-503005	K4E050601-088777
K2400S3	K4S18101-24609	K4SE027101-033620
K2400D4	K4-527592 535645	K4E-095101-106841
K2650B1	K2650B000101-026990	K2650BE000101-045147
K2650B1	K2650B500001-508015	K2650BE000101-043949
K2650C1	K2650C000001-010000	K2650BE-000101-043949
K2750B2	K2750B016101-025629	K2750BE016101025652
K21000A1	K2T00A-000101-507026	K2T00AE000101-041770

KAWASAKI 1976

<u>MODEL</u>	<u>FRAME</u>	<u>ENGINE</u>
KH100B7	GA368400-372399	G7E543332-564753
KV100A7	G4091700-098055	G4E086000-092351
KH500A8	H1F47000-52853	RAF117100-122923
KD80A2	KD080A002100-004649	KD080AE002101-004054
KD100M1	KD100M-000001-004800	KD100ME000001-004802
KE100A5	G5091700-105523	G5E90900-105523
KD125A2	K1504101-506100	K1E504101-506100
KE125A3	K1033500-046302	K1E033500-047422
KD175A1	KD175A000001-003100	KD175ME000001-003100
KE175131	KE175B000100-010304	KE175BE000100-010335
KT250A2	KT204701-08200	KT2E004801-008227
KM100A1	KM100A000001-006900	KM100AE000001-006902
KX125A3	K1908601-913600	K1E908701-913705
KX250A3	K29007701-911500	K2E907801-911400
KX400A2	K5905601-907900	K5E905601-908000
K2400D3	K4506001-527591	K4E050601-094994
K2750B1	K2750B000001-014947	K2750BE000001-015032
KZ900A1	Z1F85701-117060	Z1E086001-138846
KZ900A4	Z1F500001-515578	Z1E086001-138847
KZ900B1	KZ900B500011-505514	Z1E086001-117973

KAWASAKI 1975

<u>MODEL</u>	<u>FRAME</u>	<u>ENGINE</u>
F9C	F9F15500-22299	F5E38600-45431
F70	F7096287-114385	F7E090600-108710
G35SE	GA361514-368318	G7E518987541789
G4TRE	G4083000-091604	G4E077300-085908
H1F	H1F32400-46991	KAF102400-117002
H2C	H2F42547-47556	H2E42827-47866
ED80	ED0804000001-002017	ED0804E000001-002019
G56	G5070500-091607	G5E69700-90817
ED125	E1500001-504031	E1E500001-504027
ES125A	E1018862-033403	E1E018961-033496
ET250	ET200151-04650	ET2E000151-004704
F1113	F1131686-42637	F11E31700-42688
EX125A	E1-905001-908500	F1E905061-908613
EX250A	E2-903602-907613	E2E903681-907783
EX400	E5903001-905522	E5E903001-905584
EZ400D	E45000001-505976	E4E040507-050190
Z1B	Z1F47500-83648	Z1E047500-085847

KAWASAKI

<u>MODEL</u>	<u>YEAR</u>	<u>FRAME</u>	<u>ENGINE</u>
Z1 900cc	1973	Z1F-000001-019999	Z1E-000001-019999
Z1A 900cc	1974	Z1F-020001	Z1E-020001
FE 350cc	1970	F5-000001-007182	F5E-00000-007268
F5A 350cc	1971	F5-007183-013633	F5E-007269-013665
F6 125cc	1971	F6-000001-018129	F6E-000001-012130
F6A 125cc	1972	F6-018361-030401	F6E-012341-024446
F6B 125cc	1973	F6-030402-042370	F6E-024447-036440
F7 175cc	1971	F7-00001-025705	F7E-000001-019259
F7A 175cc	1972	F7-025706-050555	F7E-019268-044157
F7b 175cc	1973	F7-050556-072999	F7E-044158-066999
F7C 175cc	1974	F7-073001	F7E-067001
F8 250cc	1971	F8-000001-009553	F8E-000001-009785
F8A 250cc	1972	F8-009554-014549	F8E-009786-014784
F9 350cc	1972	F5-013634-024361	F5E-013666-024484
F9A 350cc	1973	F9F-000001-008999	F5E-024485-031999
F9B 350cc	1974	F9F-009001	F5E-032001
F11 250cc	1973	F11-000540	F11E-000555-016499
F11A 250cc	1974	F11-016501	F11E-016501
G3SS 90cc	1968	GA-000001-207864	FGAE-200001-205810
G3SS 90cc	1969	GA-207865-235679	FGAE-205811-223610
G3SS 90cc	1970	GA-235680-268326	FGAE-223611-268737
G3SSA 90cc	1971	GA-268327-306527	FGAE-268738-280934
G3SSB 90cc	1972	GA-306826-329102	FGAE-280935-292960
G3SSC 90cc	1973	GA-329103-354999	GAE-292961-303999
G3SSD 90cc	1974	GA-355001	G8E-500001
G4TR 100cc	1970	G4-000001-014459	FG4E-000001-014461
G4TRA 100cc	1971	G4-014460-036048	FG4E-014462-029959
G4TRB 100cc	1972	G4-036049-052152	FG4E-029960-046101
G4TRC 100cc	1973	G4-052153-069999	G4E-046102-063999
G4TRD 100cc	1974	G4-070001	G4E-064001
G5 100cc	1972	G5-000001-022026	G5E-000001-022054
G5A 100cc	1973	G5-022027-044999	G5E-022055-044999
G5B 100cc	1974	G5-04001	G5E-045001

LAVERDA

- Vin System: No example available
- Vin Location - On frame under seat. Also VIN and model number on plate attached to left side of headstock. May also be found stamped into headstock at that location.
- Engine Number - On right side of crankcase below cylinder. Also may be found on plate attached to top of right cylinder head.

MAICO

(Now being sold in US as "M-Star"). These vehicles are manufactured in Tubingen, West Germany and are Motocross or Enduro machines.

VIN SYSTEM: No example available

VIN Location - On right side of headstock

Engine Number - On right side of crankcase below cylinder in recessed area.

MATCHLESS

No longer in production. These vehicles were built in England.

VIN SYSTEM: (No example available).

VIN Location - On left front down tube or left side of headstock.

Engine Number - On twin cylinder model on front of left side of crankcase. On single cylinder model located on left center of crankcase.

MOTO BETA (MB)

These vehicles are built in Italy. None are imported into the U.S.

VIN SYSTEM: U-011438

Vin Location - On older models on right side of down tube gusset. On 1971 and later models on left or right rear motor mount or under left foot peg.

Engine Number - On top of crankcase behind cylinder, under carburetor air cleaner or on back of engine, right side.

MOTO GUZZI

Moto Guzzi Motorcycles, Mondello Del Lario, Italy.

VIN SYSTEM: No 17 digit VIN example available. For examples of VINs for older model vehicles see chart.

VIN Location - On headstock directly behind headlight.

Engine Number - Same as the VIN. Located on right side of crankcas below the right cylinder.

The following chart lists frame and engine number information from 1966-1975.

MOTO GUZZI

<u>Model</u>	<u>Approximate CC's</u>	<u>Frame/Engine Number</u>	<u>Year</u>
Sport	125	T (2 Digits) FI	1966
		T " FL	
		T " FM	
		T " FN	
		T " FP	
		T " FQ	
T " FR			
I.S.D.T. Trail	125	T (2 Digits) GD	1966-67
		T " GC	
		T " GE	
		T " GF	
Scrambler	125	T (2 Digits) HA	1966-69
		T " HB	
		T " HC	
		T " HD	
		T " HE	
		T " HF	
		T " HG	
		T " HH	
		T " HI	
		T " HL	
		T " HV	
		T " HZ	
Scrambler	125	T (2 Digits) HU	1969
		T " HV	
		T " HZ	

MOTO GUZZI Cont'd

Sport	125	T (2 Digits) GR T " GS T " GT T " GG T " GU T " GQ T " GP T " GN T " GH T " GL T " GI	1967-69
V 7	700	(4 Digits) E " K	1967-69
Ambassador	750	(5 Digits) 12000-13000-14000 14000-16000-17000 18000 series	1970
Ambassador	750	(5 Digits) 17000-18000-21000 22000-23000-24000 25000 series	1971
Ambassador	750	(5 Digits) 25000-26000 series	1972
V7 Sport	750	(5 Digits) 31000-32000 series	1972
Eldorado	850	(5 Digits) 50000-51000-52000 53000-54000-55000 56000 series	1972
Eldorado	850	(5 Digits) 55000-56000-57000 58000-59000-60000 61000 series	1973
V7 Sport	750	(5 Digits) 31000-32000-33000 series	1973

MOTO GUZZI Cont'd

Eldorado	850	(5 Digits) 50000-51000-52000 53000-54000-55000 56000 series	1972
Eldorado	850	(5 Digits) 55000-56000-57000 58000-59000-60000 61000 series	1973
V7 Sport	750	(5 Digits) 31000-32000-33000 series	1973
Eldorado	850	(5 Digits) 60000-61000 series	1974
850T	850	(5 Digits) 90000-91000-92000 93000 series	1974
V7 Sport	750	(5 Digits) 33000-34000 series	1974
Eldorado	850	(5 Digits) 61000-62000-63000 series	1975
850T		(5 Digits) 93000-94000 series	1975
850T/3		(6 Digits) 101000 series	1975

MZ

(No longer in Production)

VIN SYSTEM: No example available.

VIN LOCATION - Stamped into headstock.

Engine Number - On plate attached to left side of front fork.

NORTON

Norton-Villers-Triumph Corporation

(Discontinued Production 1976)

VIN SYSTEM:

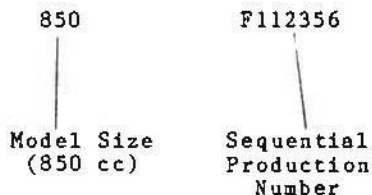

VIN Location - On left side of headstock. On early models may be on headstock or left down tube or gusset beneath oil tank. From 1969, the frame number was on a plate riveted to the headstock.

ENGINE Number - Stamped into crankcase on left forward portion immediately below cylinder. The number is placed in a 90 degree angle in the casting and is very hard to alter without detection. Until 1973, the engine and frame numbers were the same. In 1974 and 1975, these numbers were different. A typical engine number would be:

Models Produced: 314662
850 Commando
Scrambler

OSSA

Ossa motorcycles are produced in Spain. At the present time only the 350 Trails Trial is imported into the U.S.. No road machines have been imported since 1979.

VIN SYSTEM: 311-996

VIN Location - Located on front of headstock on an aluminum plate.

ENGINE Number - Same as VIN except preceded by the letter "M". Engine number is located on right front motor mount.

In 1980 the following models were imported:

250 Super Pioneer	- E
250 Super Phantom	- E
350 Trials	- T
350 Desert Phantom	- E

E=Enduro
T=Trial

In 1977 the following models were imported:

	(cc)
Super Pioneer	-175-RT
Super Pioneer	-244-RT
Desert Phantom	-244-RT
GP 11 Phantom	-244-MX
Plonker	-310-RT
Mountaineer	-310-RT

RT=Road/Trail
MX=Motocross

Prior to this, the following chart may be used for information on engine size, type, VIN parameters and years of distribution in the US.

175cc	Pioneer - 4 speed	155-459 to 155-509	1970
		155-640 to 155-690	1970
175cc	Pioneer - 5 speed	360-000 to 360-999	1971-72-73
175cc	Stiletto - 4 speed	153-000 to 153-999	1969
		155-000 to 155-399	1969
		155-400 to 155-458	1970-1975
		155-510 to 155-639	1970-1975
		155-691 to 155-999	1970-1975
175cc	Stiletto - 5 speed	350-000 to 350-999	1971-72-73
175cc	S.D.R.	361-000 TO 361-999	1973-1974
175CC	Sport		
230CC	Pioneer	250-000 to 250-200	1967
		250-201 to 250-699	1968-1975
250cc	Pioneer - 4 speed	250-700 to 250-999	1969
		251-000 to 251-739	1969
		251-740 to 254-999	1970-1974
250cc	Pioneer - 5 speed	300-000 to 303-299	1971
		303-300 to 308-999	1972-73-74-75
230cc	Stiletto	260-000 to 260-086	1969
		260-087 to 260-399	1968-1975
250cc	Stiletto - 4 speed	260-400 to 260-999	1969
		261-000 to 262-999	1970
		110-000 to 110-999	1975
250cc	Stiletto MX-5 speed	320-000 to 321-999	1971
		322-000 to 322-999	1972
		310-000 to 310-999	1975
		311-000 to 311-999	1975
250cc	Stiletto TT	370-000 to 371-999	1971-72-73-74
250cc	Plonker - 4 speed	270-000 to 270-999	1969-70
250cc	M.A.R. - 5 speed	340-000 to 345-999	1972-73-74
230cc	Wildfire	280-000 to 280-200	1967
250cc	Wildfire - 4 speed	280-201 to 280-999	1969-70-71
250cc	S.D.R.	380-000 to 382-999	1973-74
250cc	Explorer	330-000 to 331-999	1973-74
250cc	Phantom MX	180-000 to 180-999	1974
		181-000 to 181-999	1974

PENTON (Also called KTM)

(No longer imported into U.S.)
Penton motorcycles are made in Austria

VIN SYSTEM:

V023
Prior to 1972

1065076
Since 1973

VIN Location - Stamped into headstock.

ENGINE Numbers - No information available on engine numbers.

Models Produced:

100cc - Penton Berkshire
125cc - Penton Six Day
175cc - Penton Jackpiner
250cc - Penton Hare Scrambler
125cc - Penton Trials
350cc - Penton Mint

RICKMAN

(No longer in Production)

The Rickman is an assembled motorcycle made in England. The frame is the only manufactured item with engines and running gear purchased from Honda, Kawasaki or Suzuki.

VIN SYSTEM: No example available

VIN Location - Stamped into headstock.

ENGINE Number - Variable - depending on engine supplier.

ROYAL ENFIELD

(No longer in Production)

The Royal Enfield was produced in England.

VIN SYSTEM: 5396

VIN Location - On left side of frame at headstock.

ENGINE Number 1B1626
Engine Number located on left side of crankcase
below cylinder head.

SUZUKI

The Suzuki motorcycle is produced in Japan and is distributed in the United States by U.S. Suzuki Motor Corporation, 13767 Freeway Drive, Santa Fe Springs, California 90670.

According to information from R.L. Polk and Co., Detroit, Michigan, Suzuki motorcycles comprised 10.16% of new motorcycle registrations in the first quarter of 1985. In 1985, there were 2,603 unrecovered Suzuki motorcycles outstanding in California.

VIN SYSTEMS:

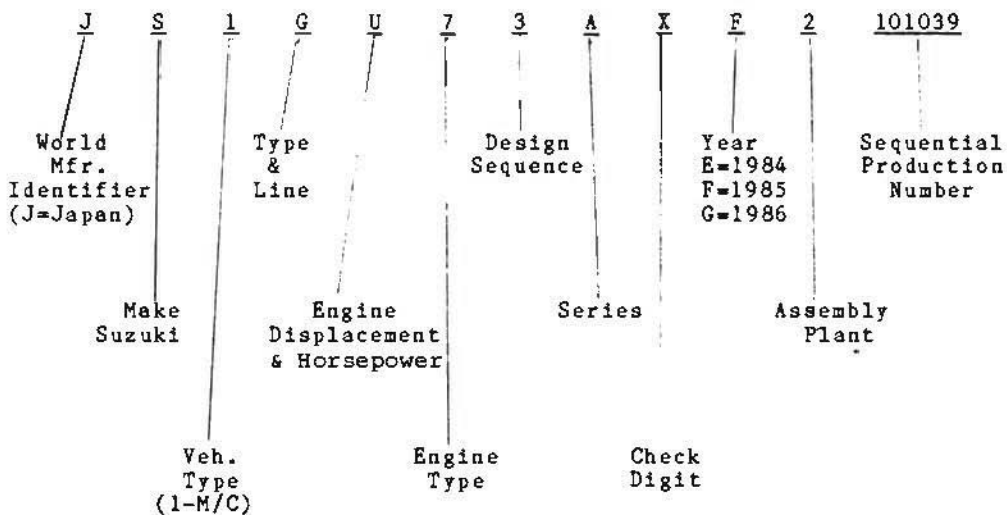

SUZUKI Cont'd

Type and Line

(On Road or Street Use)

B=Business
 F=Family
 G=Touring - L Type Multi Cyl Engine
 L=Leisure
 N=Touring - Single Cyl Engine
 V=Touring - V Type Engine
 S=On and Off Road Enduro

(Off Road Use)

D=Off Road, Play
 L=Mini Leisure
 M=Motocross
 P=Pure Enduro
 R=Motocross - High Performance

ENGINE DISPLACEMENT AND HORSEPOWER

<u>Engine Disp.cc</u>	<u>HP</u>	<u>Sym.</u>	<u>Engine Disp.cc</u>	<u>HP</u>	<u>Sym</u>
Under 50	Under 2.0	Z	451-500	27.0-55	M
Under 50	2.1-6.5	A	501-600	30.0-66.0	N
51-70	3.0-9.1	B	601-700	36.00-77.0	P
71-80	4.2-10.4	C	701-800	42.088.0	R
81-90	4.8-11.7	D	801-900	48.0-99.0	T
111-125	6.6-16.3	F	1001-1100	60.0-21.0	U
126-185.5	7.6-24.0	G	1101-1200	66.0-123.0	V
186-200	11.2-26.0	H	1201-1300	72.0-143.0	W
201-250	12.0-32.5	J	1301-1400	78.0-154.0	X
251-400	15.0-44.0	K	Over 1401	Over 84.0	Y
401-450	24.0-49.5	L			

Engine Type

<u>Engine Type</u>	<u>Symbol</u>
2 Stroke 1 Cylinder	1
2 Stroke 2 Cylinder	2
2 Stroke 3 Cylinder	3
4 Stroke 1 Cylinder	4
4 Stroke 2 Cylinder	5
4 Stroke 3 Cylinder	6
4 Stroke 4 Cylinder	7

VIN Cont'd

Vin Locations: Earlier models of the Suzuki motorcycle had their frame number locations varying from the left side of the headstock to the right side of the frame behind the engine. In 1967 models the VIN was stamped on a plate riveted to the headstock to the right of front center. Some models prior to 1969 had the number stamped on a flat surface near the swinging suspension arm pivot on the right side. Beginning in 1970, the frame and engine numbers were stamped into a plate riveted to the front of the headstock. This plate often partially or completely covered the VIN stamped into the headstock.

Engine Numbers: The engine number is generally located on either side of the crankcase below the cylinders. The frame and engine numbers generally do not match, although on some of the larger models the numbers have been found to be the same. Great care should be taken when checking an engine number through law enforcement computer systems. Frequently a "hit" will be made on a similar frame number.

Models produced 1971-1980

Following is a list of models produced from 1971 through 1980. The prefix indicates the type followed by the cc size of the engine:

TS = Enduro	GT = Sport (3 cyl)
TM = Motocross	T = Sport (2 cyl)
RV = Recreational	RE = Sport (Water Cooled Rotary)
TC = Trail	RM = Motocross Competition
GT = Sports	A100 = Sports Type (Pressed Frame)
RL = Competition (Trail)	PE = Enduro Competition
MT = Mini Trail	GS = Sports with Tubular Frame (400cc)

Initial Serial Numbers of 1971 Models

<u>Model</u>	<u>Frame</u>	<u>Engine</u>
MT50R	MT50-10001	MT50-10001
TS50R	TS50-10001	TS50-10001
F50R	F50-200250	F50-200786
TS90R	TS90-38894	TS90-38917
TC90R	TC90-01379	TC90-21387
TC120R	TC120-28133	TC120-16439
T125R	T125-114995	T125-115148
TS125R	TS125-10001	TS125-10001
TS185R	TS185-10001	TS185-10001
T250R	T250-25403	T250-25453
TS250R	TS2503-10001	TS2503-10001
T350R	T350-20746	T350-20627
TM400R	TM400-10001	TM400-10001
T500R	T500-30846	T500-30846

Initial Serial Numbers of 1972 Models

MT50J	MT50-29014	MT50-28456
TS50J	TS50-33048	TS50-33070
TS90J	TS90-207960	TS90-57996
TS90J	TS90-79277	TC90-39293
RV90J	RV90-10001	RV90-10001
TS125J	TS125-37829	TS125-37857
TC125J	TC125-10001	TC125-10001
TS185J	TS185-24292	TS185-24309
T250J	T250-45411	T250-45512
TS250J	TS2503-27153	TS2503-27192
T350J	T350-31493	T350-31493
GT380J	GT380-10001	GT380-10001
TS400J	TS400-10001	TS400-10001
TM400J	TM400-16600	TM400-16600
T500J	T500-46463	T500-46463
GT750J	GT750-10001	GT750-10001

Initial Serial Numbers of 1973 Models

<u>Model</u>	<u>Frame</u>	<u>Engine</u>
MT50K	MT50-47830	MT50-47922
TS50K	TS50-43847	TS50-45089
TS100K	TS100-10001	TS100-10001
TC100K	TC100-10001	TC100-10001
RV90K	RV90-35601	RV90-36393
TS125K	TS125-58493	TS125-58544
TC125K	TC125-30925	TC125-30943
RV125K	RV125-10001	TV125-10001
TM125K	TM125-10001	TM125-10001
TS185K	TS185-52592	TS185-52618
GT185K	GT185-10001	GT185-10001
GT250K	GT250-10001	GT250-10001
TM250K	TM250-34739	TM250-34750
TS250K	TS2503-48350	TS2503-48387
GT380K	GT380-30919	GT380-32894
TS400K	TS400-19019	TS400-19059
TM400K	TM400-30001	TM400-30006
T500K	T500-59779	T500-59779
GT550K	GT550-21780	GT550-23036
GT750K	GT750-31253	GT750-31357

Initial Serial Numbers of 1974 Models

TS50L	TS50-72870	TS50-62891
TM75L	TM75-10001	TM75-10001
RV90L	RV90-57055	RV90-57881
TS100L	TS100-22334	TS100-22347
TC100L	TC100-21892	TC100-21899
TM100L	TM100-10001	TM100-10001
RV125L	RV125-23435	RV125-23449
TM125L	TM125-20579	TM125-20603
TS125L	TS125-74802	TS125-74836
TC125L	TC125-39065	TC125-39079
TS185L	TS185-10001	TS1855-10001
TS185L	TS185-84664	TS185-84307
GT185L	not available	not available
TS250L	TS2503-66063	TS2503-66131
TM250L	TM250-41777	TM250-41824
GT250L	GT250-25966	GT250-26026
RL250L	RL250-10001	RL250-10001
GT380L	GT380-48732	GT380-53849

1974 Models Cont'd

<u>Model</u>	<u>Frame</u>	<u>Engine</u>
TS400L	not available	not available
TM400L	TM400-33482	TM400-33500
T500L	T500-68083	T500-68083
GT550L	GT550-36266	GT550-37851
GT750L	GT750-40247	GT750-43041

Initial Serial Numbers of 1975 Models

TM75M	TM75-20705	TM75-20720
TS75M	TS75-N/A	TS75-N/A
RV90M	RV90-70623	RV90-71552
TC100M	TC100-37259	TC100-38269
TM100M	TM100-N/A	TM100-N/A
TS100M	TS100-38593	TS100-43661
TC125M	TC125-49552	TC125-49571
TM125M	TM125-43175	TM125-44499
TS125M	TS125-98283	TS125-98376
RV125M	RV125-34030	RV125-34044
GT185M	GT185-31693	GT185-34971
TC185M	TC185-15995	TC185-16001
TS185M	TS185-115944	TS185-115997
GT250M	GT250-47326	GT250-45157
RL250M	RL250-18199	RL250-18223
TM250M	TM250-49511	TM250-49589
TS250M	TS2503-86770	TS2503-86853
GT380M	GT380-65984	GT380-73229
TM400M	TM400-47918	TM400-47957
TS400M	TS4003-15956	TS4003-15968
T500M	T500-74162	T500-74168
GT550M	GT550-47119	GT550-49302
GT750M	GT750-52823	GT750-57533
RE5M	RE5-10053	RE5-10112

Initial Serial Numbers of 1977 Models

TS75B	TS7523322	TS7528802
RV90B	RV9090674	RV9091633
TC100B	TC10048727	TC10048717
TS100B	TS10063728	TS10069712
TC125	TC12558658	TC12558665
TS125B	TS125145379	TS125147370

1977 Models Cont'd

<u>Model</u>	<u>Frame</u>	<u>Engine</u>
RV125B	RV12546525	RV12546538
TC185	TC18524074	TC18524059
TS185B	TS185210001	TS1852100
GT250B	GT25097426	GT25097528
TS250B	TS250410001	TS250410001
GT380B	GT38095063	GT380108577
TS400B	TS400330145	TS400330154
GT500B	T500104422	T500104426
GT550B	GT55070364	GT55073451
GT750B	GT75075539	GT75082605
RE5	RE5-unk	RE5-unk
RM80B	RM8010001	RM8010001
RM100B	RM10016022	RM10016024
RM125B	RM12543983	RM12544045
RM250B	RM25020995	RM25021013
RM370B	RM37017939	RM37017946
A100B	A100216676	A100313991
PE250B	PE25010001	PE2501001
GS400B	GS40010001	GS40010001
GS550B	GS550100001	GS550100001
GS750B	GS75010001	GS75010001
GS400XB	GS400X10001	GS400X10001

Initial Serial Numbers of 1978 Models

RM50C	RM50100001	RM50100001
RM80C	RM8023349	RM8023635
RM100C	RM10023120	RM10023134
RM125C	RM12561851	RM12562013
RM250C	RM25030642	RM25030700
RM400C	RM400100001	RM400100009
JR50C	JR50100001	JR50100001
DS80C	DS80100001	DS80100001
DS100C	DS100100001	DS100100001
DS185C	DS185100001	TS1852500001
TS100C	TS1002100001	TS1002100001
TS125C	TS1252100001	TS1252100001
TS185C	TS185224007	TS185224309
TS250C	TS250421294	TS250421606
DR370C	DR370100001	DR370100001
PE175C	PE175100001	PE175100001
PE250C	PE25018647	PE25018666

1978 Models Cont'd

<u>Model</u>	<u>Frame</u>	<u>Engine</u>
SP370C	SP370100001	SP370100001
GS400C	GS40032557	GS40032745
GS400XC	GS400X13045	GS400X13354
GS550C	GS550110407	GS550114441
GS550EC	GS550E100018	GS550E114487
GS750	GS75032608	GS75043683
GS750EC	GS750E100019	GS750E44144
GS1000C	GS1000100001	GS1000100001
GS1000EC	GS1000500001	GS1000100001

Initial Serial Numbers of 1979 Models

RM50N	RM107414	RM50107453
RM80N	RM39433	RM8039470
RM100N	RM10028312	RM10028328
RM125N	RM12584328	RM12584645
RM250N	RM25038834	RM2503903
RM400N	RM400105660	RM400105681
JR50N	JR50110285	JR50110406
DS80N	DS80119924	DS80116895
DS100N	DS100109768	DS100109832
DS185N	DS185107722	TS185250772
TS100N	TS1002119992	TS1002132991
TS125N	TS1252144190	TS1252146509
TS185N	TS185239295	TS185239548
TS250N	TS250433581	TS25043392
DR370N	DR370105460	DR370105486
PE175N	PE175107290	PE175102298
PE250N	PE25023045	PE25022632
SP370N	SP370109645	SP370109448
GS425N	GS425100037	GS425100016
GS425EN	GS425500032	GS425100016
GS550N	GS550119862	GS550139272
GS550EN	GS550E115731	GS550E139272
GS750N	GS75044361	GS75074016
GS750EN	GS750E29475	GS75074016

Initial Serial Numbers of 1980 Models

JR50T	JR50121204	JR50121238
OR50T	OR50163309	OR50163361
FZ50T	FZ50142998	FZ50143001
RM50T	RM50110854	RM50110894
TS100T	TS1002301267	TS1002149748
TS125T	TS1252307475	TS1252164154
TS185T	TS1852102185	TS185248283
TS250T	TS2504100841	TS250438344
SP400T	SP400100034	SP400100036
DS80T	DS80126125	DS80126165
DS100T	DS100117307	DS100117312
DS125T	DS125104361	DS125104361
DS185T	DS185111300	TS1852511300
DS250T	DS250100009	TS2504500009
DR400T	DR400100042	DR400100043
PE175T	PE175200030	PE175200039
PE250T	PE250200030	PE250200037
PE400T	PE400100033	PE400100034
RM60T	RM60102731	RM60102731
RM80T	RM80200010	RM80200068
RM100T	RM10033044	RM10027822
RM125T	RM125102503	RM12583087
RM250T	RM25043892	RM25044025
RM400T	RM400109717	RM400109785
GS450ET	GS450500049	GS450100096
GS450ST	GS450500421	GS450100096
GS450LT	GS450700018	GS450109969
GS550ET	GS550E125125	GS550159165
GS550LT	GS550E705236	GS550159165
GS750ET	GS75X500030	GS75X100097
GS750LT	GS75X700016	GS75X100097
GS850GT	GS850116457	GS850116520
GS850GLT	GS850700025	GS850116520
GS1000ET	GS1000528511	GS100014596
GS1000GT	GS100G100046	GS100G100031
GS1000GLT	GS100G700017	GS100G100040
GS1000ST	GS1000528511	GS1000145969
GS1100ET	GS110X500037	GS110X100166
GS1100LT	GS110X700016	GS110X100166
FS50T	FS50100052	FS50100053
RS250T	RS250100011	RS250100011
GN400T	GN400500028	GN400100051
GN400XT	GN400100022	GN400100051
GS250TT	GS25X106427	GS25X700020
FA50T	FA100047	FA50100049

TRIUMPH

Triumph Motorcycles, Coventry, England
(Production Discontinued-1983)

VIN SYSTEM: (1981-1983)

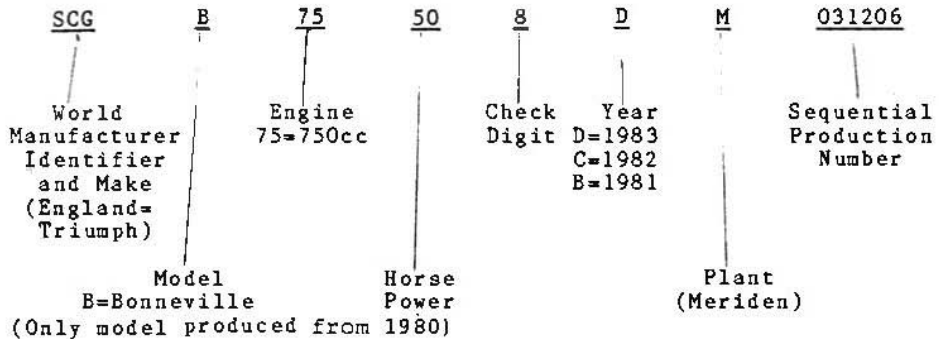

Vin Location- Left side of headstock or on down tube of frame,
left side.

Vin System- Prior to 1981. (This system began in 1969)

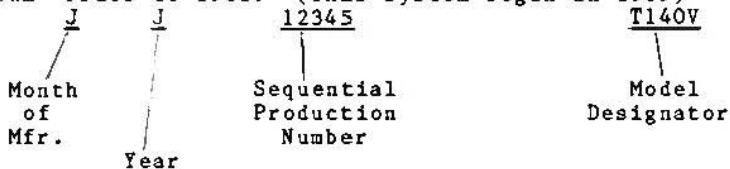

1st LETTER

A - January
B - February
C - March
D - April
E - May
G - June
H - July
J - August
K - September
N - October
P - November
X - December

2nd LETTER

C - 1969
D - 1970
E - 1971
G - 1972
H - 1973
J - 1974
K - 1975
N - 1976
P - 1977
X - 1978
A - 1979
B - 1980

Following is a list of the various models manufactured for each respective year with different engine sizes and model code designators. The letter "V" indicates a 5-speed transmission.

1975

Trident-750
(Only model produced)

1974

Bonneville-750-T140V
Trident-750-T1550V
Tiger-750-TR7RJ
Daytona-500-T100R
Trophy Trail-500-TR5T
Avenger-500-TR5MX

1973

Bonneville-750-T140 or T140RV
Trident-750-T150V
Tiger-750-TR7RV
Daytona-500-T100R
Trophy Trail-500-TR5T
Hurricane-750-TRX75

1972

Bonneville-650-T120R
Bonneville-650-T120RV or T120V
Trident-750-T150
Trident-750-T150V
Tiger-650-TR6R
Tiger-650-TR6RV

Daytona-500-T100R
Trophy-650-TR6C
Trophy-500-T100C

1971

Bonneville-650-T120R
Bonneville-650-T120RV
Trident-750-T150
Trident-750-T150V
Tiger-650-TR6R
Daytona-500-T100R
Trophy-650-TR6C
Trophy-500-T100C
Blazer-250-T25SS
Trail Blazer-250-T25T

1970

Bonneville-650-T120R
Bonneville-750-T120RT

Trident-750-T150
Tiger-650-TR6R
Daytona-500-T100R
Trophy-250-TR25W
Trophy-500-T100C
Trophy-650-TR6C

1969

Bonneville-650-T120R
Trident-750-T150
Tiger-650-TR6R
Daytona-500-T100R
Trophy-250-TR25W
Trophy-500-T100C
Trophy-650-TR6C

1968

Bonneville-650-T120R
Tiger-650-TR6R
Daytona-500-T100R
Trophy-250-TR25W
Trophy-500-T100C
Trophy-650-TR6C

Vin System - Prior to 1969 the VIN was composed of a model designator as a prefix, followed by two letters which represented the engine size and a five digit sequential production number.



Engine Number - Located on left side of engine crankcase at base of cylinder. From 1968 the engine number is stamped on a raised boss in this location. Beginning in 1969 the boss was inscribed with the Triumph logo prior to the number being stamped. Beginning in 1965 the frame and engine numbers are the same (although some exceptions have been noted). Prior to 1965 these numbers were different.

VELOCETTE

(No Longer in Production)

VIN SYSTEM: VNE-10062

VIN Location - On rear of top bar on frame, underneath right rear of gas tank (not visible except in short tank - Scrambler and Endurance Models).

Engine Number - Stamped on left side of engine case.

VESPA

Vespa Motorcycles and Mopeds are imported through BIANCHI Vespa of America Corporation, 385 Oyster Point Blvd. #6, South San Francisco, California 94080

VIN SYSTEM: All Vespa products have a prefix that precedes the frame serial number. This prefix corresponds to the following identification:

MOPEDS

FRAME PREFIX

Ciao Standard	C7N1T
Ciao Special	C7E1T
Ciao Super	C7V3T
Ciao Supreme	
(Model equipped with turn signals)	C7E1T(C7E1T/B)
Bravo Deluxe	EEV1T
Bravo Super Deluxe	
(Model equipped with turn signals)	EEV1T/B
Grande Deluxe	048
Grande Super Deluxe	
(Model equipped with turn signals)	048/B

MOTORSCOOTERS

FRAME PREFIX

ENGINE PREFIX

Vespa 90 Sport	V9A1T	V9A1M
Vespa 125 Primavera	VMA2T	VMA2M
Vespa 150 Super	VBC1T	VBC1M
Vespa 150 Sprint	VLB1T	VLB1M
Vespa 200 Rally	VSE1T	VSE1M
Vespa 50 Special	V5B3T	V5A4M
Vespa P125X	VNX1T	VNL4M
Vespa P200E	VSX1T	VSE1M

Frame and Engine Number Locations

Models - C7N1T, C7E1T, C7V3T, C7E1T (C7E1T/B)

Frame Number - Under plastic chain protection cover, right side.

Engine Number - On right side of engine adjacent to cylinder head.

Models - 048, 048/B

Frame Number - On headstock, left side.

Engine Number - On right side of engine case, adjacent to cylinder head.

Models - V9A1T, VMA2T

Frame Number - Stamped on right side just above engine. It is necessary to remove engine side cover to see number.

Engine Number - On rear of crankcase next to oil fill plug.

Models - VNX1T, VSX1T

Frame Number - Stamped on body, right rear side (remove cowling).

Engine Number - Stamped on engine swingarm adjacent to exhaust pipe.

Models - VBC1T, VLB1T

Frame Number - Stamped on body, left side, below left cowl next to exhaust pipe.

Engine Number - Stamped on engine swingarm adjacent to exhaust pipe.

Model - VSE1T

Frame Number - Stamped on body, right rear side (remove cowling)

Engine Number - Stamped on engine swing arm adjacent to exhaust pipe.

Model - V5B3T

Frame Number - Stamped on body, right side, just above engine (remove side cover).

Engine Number - Stamped on rear of crankcase next to oil fill plug.

YAMAHA

Yamaha motorcycles are produced in Iwata, Japan. The United States distributor is Yamaha Motor Corporation, P.O. Box 6555, Cypress, California 90630. The Yamaha motorcycle is an extremely popular machine and according to R.L. Polk and Co., Detroit, comprised 16.05% of new motorcycle registrations in the first quarter of 1985. In 1985 there were 5,807 outstanding stolen Yamaha motorcycles in California. This is second only to Honda.

VIN SYSTEMS: 1981-1986

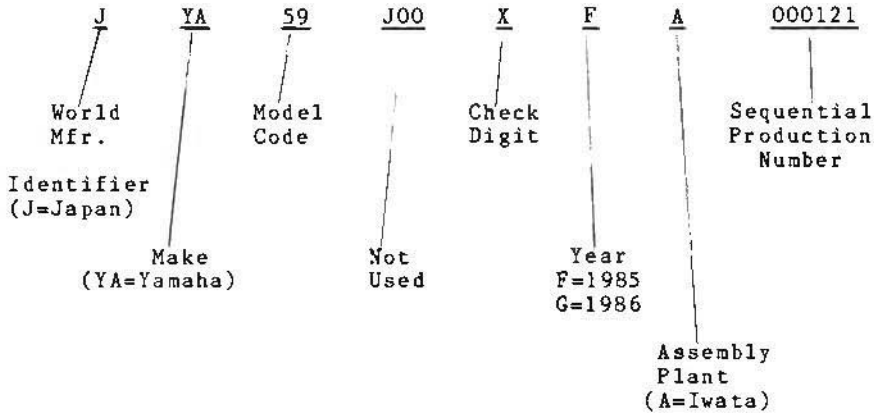

1985 Motorcycle Frame, Engine, and Model Numbers

STREET

<u>MODEL</u>	<u>ACTUAL DISPLACEMENT</u>	<u>MODEL CODE</u>	<u>STARTING PRIMARY ID NUMBER</u>	<u>STARTING VIN/FRAME NUMBERS</u>
XVZ12DN	1198	59J	59J-000101	JYA59J00()FA000101
VMX12N	1198	1FK	1FK-000101	JYA1FK00()FA000101
VMX12NC	1198	1JH	1JH-000101	JYA1JH00()FA000101
FJ1100N	1097	50H	50H-010101	JYA50H00()FA010101
FJ1100NC	1097	47M	47M-010101	JYA47M00()FA010101
XV1000N	981	56V	56V-000101	JYA56V00()FA000101
XV1000NC	981	56W	56W000101	JYA56W00()FA000101
FZ750N	750	1AE	1AE-000101	JYA1AE00()FA000101
KJ700XN	697	1AA	1AA-000101	JYA1AA00()FA000101
XJ700XNC	697	1FJ	1FJ-000101	JYA1FJ00()FA000101
KJ700NC	696	1JJ	1JJ-000101	JYA1JJ00()FA000101
XV700N	699	56E	56E-000101	JYA56E00()FA000101
XV700NC	699	56F	56F-000101	JYA56F00()FA000101
FJ600N	598	49A	49A-007101	JYA49A00()FA007101
FJ600NC	598	51K	51K-001101	JYA51K00()FA001101
RZ350N	347	48H	48H-010101	JYA48H00()FA010101
RZ350NC	347	1EL	1EL-000101	JYA1EL00()FA000101
QT50N	49	5U9	5U9-120101	JYA5U900()FA120101

ENDURO

XT600N	595	49N	49N-005101	JYA49N00()FA005101
XT600NC	595	49R	49R-002101	JYA49R00()FA002101
XT350N	346	57T	57T-000101	JYA57T00()FA000101
XT350NC	346	56R	56R-000101	JYA56R00()FA000101

OFFROAD

TT600N	595	55U	55U-000101	JYA55U00()FA000101
YZ490N	487	57H	57H-000101	JYA57H00()FA000101
TY350N	341	46Y	46Y-000101	JYA46Y00()FA000101
YZ250N	246	56A	56A-000101	JYA56A00()FA000101
IT200N	195	43G	43G-007101	JYA43G00()FA007101
BW200N	196	54G	54G-000101	JYA54G00()FA000101
YZ125N	123	55Y	55Y-000101	JYA55Y00()FA000101
YZ80N	83	58T	58T-000101	JYA58T00()FA000101
PW80N	79	21W	21W-110101	JYA21W00()FA110101

1985 Motorcycles Cont'd

<u>MODEL</u>	<u>ACTUAL DISPLACEMENT</u>	<u>MODEL CODE</u>	<u>STARTING PRIMARY ID NUMBER</u>	<u>STARTING VIN/FRAME NUMBERS</u>
<u>OFFROAD</u>				
PW50N	49	36E	36E-008101	JYA36E00()FA008101
<u>MOTO-4</u>				
YFM200N	196	52H	52H-000101	JY452H00()FC000101
YFM80N	79	55X	55X-000101	JY455X00()FC000101
<u>TRI-MOTO</u>				
YTZ250N	246	38W	38W-000101	JY338W00()FC000101
YTM225DXN	223	29U	29U-100101	JY329U00()FC100101
YTM200ERN	196	52G	52G-000101	JY352G00()FC000101
YTM200N	196	21V	21V-160101	JY321V00()FC160101
YT125N	123	21Y	21Y-070101	JY321Y00()FC070101
YT60N	59	36R	36R-063101	JY336R00()FC063101
<u>RIVA</u>				
XC180DN	171	54L	25J-136101	JYA25J00()FA136101
XC180DNC	171	54M	25J-136101	JYA25H00()FA136101
XC180ZN	171	46T	25J-141101	JYA25J00()FA141101
XC180ZNC	171	46T	25H-141101	JYA25H00()FA141101
XC125N	124	50M	50M-000101	JYA50M00()FA000101
XC125NC	124	50N	50N-000101	JYA50N00()FA000101
CV80N	79	32Y	32Y-000101	JYA32Y00()FA662101
CA50N	49	20G	14T-662101	JYA14T00()FA662101

1983 & 1/2 -1984 Motorcycle Frame, Engine & Model Numbers

STREET

XVZ12DL	1198	41V	41V-000101	JYA41V00()	EA000101
XVZ12L	1198	41R	41R-000101	JYA41R00()	EA000101
XVZ12DKC2*	1198	47T	47T-000101	JYA47T00()	DA000101
XVZ12KC2*	1198	47R	47R-000101	JYA47R00()	DA000101
FJ1100L	1097	50H	50H-000101	JYA50H00()	EA000101
FJ1100LC*	1097	47M	47M-000101	JYA47M00()	EA000101
XV1000L	981	42G	42G-000101	JYA42G00()	EA000101
XV1000LC*	981	42H	42H-000101	JYA42H00()	EA000101
XV700L	699	42W	42W-000101	JYA42W00()	EA000101
XV700LC*	699	42X	42X-000101	JYA42X00()	EA000101
FJ600L	598	49A	49A-000101	JYA49A00()	EA000101
FJ600LC*	598	51K	51K-000101	JYA51K00()	EA000101
RZ350L	347	48H	48H-000101	JYA48H00()	EA000101
QT50L	49	5U9	5U9-100101	JYA5U900()	EA100101
RX50L	49	23H	23H-110101	JYA12H00()	EA110101

ENDURO

XT600L	595	49N	49N-000101	JYA49N00()	EA000101
XT600LC*	595	49R	49R-000101	JYA49R00()	EA000101
XT250L	249	42U	42U-000101	JYA42U00()	EA000101
XT250LC*	249	43E	43E-000101	JYA43E00()	EA000101

OFF-ROAD

TT600L	595	34K	34K-020101	JYA34K00()	EA020101
YZ490L	487	40T	40T-000101	JYA40T00()	EA000101
YZ250L	246	39X	39X-000101	JYA39X00()	EA000101
YZ125L	123	39W	39W-000101	JYA39W00()	EA000101
YZ80L	83	39K	39K-000101	JYA39K00()	EA000101
IT490L	487	26A	26A-100101	JYA26A00()	EA100101
IT200L	195	43G	43G-000101	JYA43G00()	EA000101

MOTORCYCLE FRAME, ENGINE AND MODELS NUMBERS Cont'd

RIVA - 1984

XC180L	171	25J	25J-100101	JYA25J00()	EC100101*
XC180LC	171	25H	25H-100101	JYA25H00()	EC100101*
XC180ZL	171	45L	25J-130101	JYA25J00()	EA130101
XC180ZLC	171	46T	25H-130101	JYA25H00()	EA130101
CV80L	79	13T	13T-100101	JYA13T00()	EC100101*
CV50L	49	46H	39H-007101	JYA39H00()	DC007101*
CA50L	49	20G	14T-210101	JYA14T00()	EC210101*

*Some units of these models were mfg. at a different plant and therefore require slightly different VIN/Frame numbers.

<u>MODEL</u>	<u>ADDITIONAL STARTING VIN/FRAME NUMBER</u>
XC180L	JYA25J00()EA101101
XC180LC	JYA25H00()EA100701
CV80L	JYA13T00()EA100701
CV50L	JYA39H00()EA007601
CA50L	JYA14T00()EA211601

TRI-MOTO - 1984

YTM225DXL	223	29U	29U-060101	29U-060101
YTM200EL	196	24W	24W-100101	24W-100101
YTM200L	196	21V	21V-100101	21V-100101
YT125L	123	21Y	21Y-050101	21Y-050101
YT60L	59	36R	36R-000101	36R-000101

1982 MOTORCYCLE FRAME, ENGINE & MODEL NUMBERS

STREET

<u>MODEL</u>	<u>STARTING ENGINE/FRAME NO.</u>	<u>STARTING 17-DIGIT VIN</u>
LB50PJ	2U7-060101	JYA-2U700 -()CA-060101
QT50J	5U9-000101	JYA-5U900 -()CA-000101
MJ50J	5N7-000101	JYA-5N700 -()CA-000101
SR185J	11E-000101	JYA-11E00 -()CA-000101
SR250J	5V0-000101	JYA-5V000 -()CA-000101
XS400J	12R-000101	JYA-12R000-()CA-000101
XS400SJ	14V-000101	JYA-14V00 -()CA-000101
XS400RJ	16M-000101	JYA-16M00 -()CA-000101
XJ550J	5K5-020101	JYA-5K500 -()CA-020101
XJ550RJ	4U8-020101	JYA-4U800 -()CA-020101
XZ550RJ	11H-000101	JYA-11H00 -()CA-000101
XJ650J	5N8-000101	JYA-5N800 -()CA-000101
XJ650RJ	5V2-000101	JYA-5V200 -()CA-000101
XJ650LJ	16G-000101	JYA-16G00 -()CA-000101
XS650SJ	5V4-000101	JYA-5V400 -()CA-000101
XJ750J	15R-000101	JYA-15R00 -()CA-000101
XJ750RJ	5G2-100101	JYA-5G200 -()CA-100101
XV750J	4X7-200101	JYA-4X700 -()CA-200101
XV920J	10L-000101	JYA-10L00 -()CA-000101
XV920RJ	5H1-100101	JYA-5H100 -()CA-100101
XJ1100J	10M-000101	JYA-10M00 -()CA-000101

ENDURO

DT80J	3J8-150-101	JYA-3J800 -()CA-150101
DT100J	3A3-070101	JYA-3A300 -()CA-070101
XT125J	15E-000101	JYA-15E00 -()CA-000101
XT1200J	15A-000101	JYA-15A00 -()CA-000101
XT1250J	3Y1-120101	JYA-3Y100 -()CA-120101
XT550J	5Y1-000101	JYA-5Y100 -()CA-000101

OFF-ROAD

PW50J	4X4-2000101
MX80J	367-654111
MX100J	3T0-064857
TT250J	3Y0-150101
IT175J	5X8-000101
IT250J	4V5-020101
IT465J	4V6-010101

1982 MOTORCYCLE FRAME, ENGINE, AND MODEL NUMBERS CONT'D

OFF-ROAD Cont'd

<u>VIN</u>	<u>MODEL</u>	<u>STARTING ENGINE/FRAME NO.</u>	<u>STARTING 17-DIGIT</u>
	YZ60J	5X1-000101	
	YZ80J	5X2-000101	
	YZ100J	5X3-000101	
	YZ125J	5X4-000101	
	YZ250J	5X5-000101	
	YZ490J	5X6-000101	
	YT125J	5V6-000101	
	YT175J	5V7-000101	

1981 MOTORCYCLE FRAME, ENGINE, AND MODEL NUMBERS.

<u>MODEL</u>	<u>ENGINE/FRAME PREFIX (DESIGNATES MODEL)</u>	<u>17 DIGIT START NO.</u>
LB50H	2U7	JYA-2U700-()-BA-054761
LC50H	3L9	JYA-3L900-()-BA-00862
QT50H-B/R	3L5	JYA-3L500-()-BA-240660
SR185-B/R	5H0	JYA-5H000-()-BA-000101
SR250H-B/R	3Y6	JYA-3Y600-()-BA-112653
SR250TH	3Y6	JYA-3Y600-()-BA-101801
XS400H-B/R	4Y5	JYA-4R500-()-BA-003351
XS400SH-B/R	4R4	JYA-4R400-()-BA-003361
SR500H	4R8	JYA-4R800-()-BA-001218
XJ550H-B/R	5K5	JYA-5K500-()-BA-000101
XJ550RH	4U8	JYA-4U800-()-BA-000101
XS650H-B/R	4N9	JYA-4N900-()-BA-005079
XS650SH-B/S	4M4	JYA-4M400-()-BA-005951
XJ650H-B/S	4H7	JYA-4H700-()-BA-106297
XJ650LH	4W5	JYA-4W500-()-BA-001201
XJ750RH-B/R	5G2	JYA-5G200-()-BA-000101
XV750H-B/R	4X7	JYA-4X700-()-BA-000101
XS850H	4R3	JYA-4R300-()-BA-001201
XS850SH-B/R	4R2	JYA-4R200-()-BA-003801
XS850LH	4W3	JYA-4W300-()-BA-000254
XV920RH	5W1	JYA-5W100-()-BA-000101
XS1100H	4R1	JYA-4R100-()-BA-002001
XS1100SH-B/R	4R0	JYA-4W100-()-BA-000801
DT80H	3J8	JYA-3J800-()-BA-102361
DT100H	3A3	JYA-3A300-()-BA-041631
DT125H	3J0	JYA-3J000-()-BA-051151
DT175H	3J1	JYA-3J100-()-BA-063066
XT250H-R/S	3Y1	JYA-3Y100-()-BA-102401
XT500H	4R9	JYA-4R900-()-BA-001818

VIN Locations - Stamped into the right side of headstock. In 1981 and 1982 models this number consisted of a nine digit number that was a derivative of the full 17 digit VIN.

Example: J Y A 4 L 4 0 0 3 B A 2 4 0 6 6 0 (17 digit VIN)
4 L 4 2 4 0 6 6 0 (9 digit VIN stamped on frame)

The full 17 digit VIN was shown in its entirety on the Federal Certification Label. If the vehicle was intended for off-road use, there was no Federal Certification Label and the vehicle could only be identified by the nine digit number.

Beginning in 1983, the full 17 digit VIN was stamped on the headstock. The same number was repeated on the Federal Certification Label. If the vehicle was intended for off road use, there will be no Federal Certification Label.

Engine Numbers - The Yamaha engine number is a derivative of the VIN.

Example: VIN: J Y A 5 9 J 0 0 1 F A 0 0 0 1 0 1
Engine #: 5 9 J 0 0 0 1 0 1

This number is stamped on top of the left or right side of the front portion of the engine.

VIN SYSTEM: 1974-1980

In 1974 the model number was changed and indicated the following:

Each Model designation consists of three parts: alphabetical prefix, number and alphabetical suffix.

<u>Example:</u>	DT100A	<u>Model</u>	<u>Engine Size</u>	<u>Year</u>
		DT	100	A
		(Enduro)	(Cubic Centimeters)	(1974)

The prefix consists of two letters that indicate the type of motorcycle.

Prefix	Type
LB	Street - 2 stroke
RD	
RS	
LC	
QT	Street - 4 stroke
SR	
TX	
XS	
XJ	Mini
GT	
DT	Enduro
XT	Off-Road
IT	
TT	
YT	Moto Cross-Regular
MX	
YZ	Racer
SC	Scrambler
TA	Road Racer - Air Cooled
TZ	Water cooled
TY	Trial

The middle portion, which describes the engine's displacement in cubic centimeters, consists of two, three, or four numbers, depending upon the size of the engine. The final single letter represents the model year. These letters are alphabetically assigned, beginning with "A" in 1974.

VIN System Cont'd

These combinations were then translated into an all numeric prefix which was part of the frame number.

Example:

Model#:	RD	350	A	Frame #
				= 351-123456
	Street	350cc	1974	
	2 stroke	Engine		

VIN Location: - Stamped into headstock right side. The engine number was the same as the frame number .

Engine Number Locations: - This varied according to model and engine size.

The following chart shows model number, frame prefix and engine number location from 1974-1976.

1974 MODELS

<u>MODEL</u>	<u>CC</u>	<u>FRAME,ENGINE PREFIX</u>	<u>ENGINE NUMBER LOCATION</u>
<u>STREET</u>			
RD60A	60	388-6 digits	Left side of engine
RD200A	200	397-6 digits	Left side of engine
RD250A	250	352-6 digits	Right side of engine
RD350A	350	351-6 digits	Right side of engine
TX500A	500	371-6 digits	Left side of engine
TX650A	650	447-6 digits	Front of engine
<u>STREET/TRAIL</u>			
GT80A	80	393-6 digits	Left side of engine
DT100A	100	437-6 digits	Right side of engine
DT125A	125	444-6 digits	Left side of engine
DT175A	175	443-6 digits	Right side of engine
DT250A	250	450-6 digits	Right side of engine
DT360A	360	446-6 digits	Right side of engine
<u>MOTOCROSS</u>			
GTMXA	80	367-6 digits	Left side of engine
MX100A	100	427-6 digits	Right side of engine
MX125A	125	402-6 digits	Right side of engine
MX175A	175	455-6 digits	Right side of engine
MX250A	250	364-6 digits	Left side of engine
MX360A	360	365-6 digits	Left side of engine
SC500A	500	363-6 digits	Left side of engine
YZ80A	80	462-6 digits	Left side of engine
YZ125A	125	453-6 digits	Left side of engine
YZ250A	250	431-6 digits	Left side of engine
YZ360A	360	432-6 digits	Left side of engine
<u>TRIALS</u>			
TY80A	80	451-6 digits	Left side of engine
TY250A	250	434-6 digits	Left side of engine

VIN Sytem Cont'd

<u>MODEL</u>	<u>CC</u>	<u>FRAME, ENGINE PREFIX</u>	<u>ENGINE NUMBER LOCATION</u>
<u>STREET</u>			
<u>1975 MODELS</u>			
RD60B	60	388-6 digits	Left side of engine
RS100B	100	465-6 digits	Left side of engine
RD125B	125	507-6 digits	Left side of engine
RD200B	200	397-6 digits	Left side of engine
RD250B	250	352-6 digits	Right side of engine
RD350B	350	351-6 digits	Right side of engine
XS500B	500	371-6 digits	Left side of engine
XS650B	650	447-6 digits	Front of engine
<u>STREET/TRAIL</u>			
GT80B	80	393-6 digits	Left side of engine
DT100B	100	437-6 digits	Right side of engine
DT125B	125	444-6 digits	Left side of engine
DT175B	175	443-6 digits	Right side of engine
DT250B	250	450-6 digits	Right side of engine
DT400B	400	501-6 digits	Right side of engine
<u>MOTOCROSS</u>			
GTMXB	80	367-6 digits	Left side of engine
MX100B	100	427-6 digits	Right side of engine
MX125B	125	402-6 digits	Right side of engine
MX175B	175	455-6 digits	Right side of engine
MX250B	250	509-6 digits	Right side of engine
MX400B	400	510-6 digits	Right side of engine
YZ80B	80	492-6 digits	Left side of engine
YZ125B	125	453-6 digits	Left side of engine
YZ250B	250	483-6 digits	Left side of engine
YZ360B	360	484-6 digits	Left side of engine
<u>TRIALS</u>			
TY80B	80	451-6 digits	Left side of engine
TY175B	175	525-6 digits	Left side of engine
TY250B	246	493-6 digits	Left side of engine

VIN System Cont'd

<u>MODEL</u>	<u>CC</u>	<u>FRAME, ENGINE PREFIX</u>	<u>ENGINE NUMBER LOCATION</u>
<u>STREET</u>			
<u>1976 MODELS</u>			
LB80-IIAC	80	591-6 digits	Left side of engine
LB80-IIHC	80	542-6 digits	Left side of engine
RS100C	100	465-6 digits	Top left
RD125C	125	507-6 digits	Top left
RD200C	200	581-6 digits	Top left
XS650C	650	447-6 digits	Top front
<u>STREET/TRAIL</u>			
GT80C	80	393-6 digits	Top left
DT100C	100	558-6 digits	Top right
DT125C	125	560-6 digits	Top left
DT175C	175	559-6 digits	Top right
DT250C	250	450-6 digits	Top right
DT400C	400	501-6 digits	Top right
<u>MOTOCROSS</u>			
YZ125C	125	537-6 digits	Right side of engine
GTMXC	80	367-6 digits	Top left
MX125C	125	565-6 digits	Top right
YZ80C	80	598-6 digits	Top left
TT500C	500	583-6 digits	Top right
<u>TRIALS</u>			
TY175C	175	525-6 digits	Top right
<u>STREET</u>			
<u>MODEL</u>		<u>I.D. PREFIX</u>	<u>ENGINE NUMBER LOCATION</u>
XS360C		1L9-6 digits	Top right
XS500C		1J3-6 digits	Top right
XS750D		1J7-6 digits	Top right
XT500C		1G8-6 digits (125cc)	
		1E6-6 digits (300cc)	
<u>RACER</u>			
YZ250C		509-6 digits	Top right
YZ400C		510-6 digits	Top right

Due to the fact that the frame and engine prefixes are different on the older model Yamahas, it is essential that both the VIN and engine number be checked when making an inquiry through SVS or NCIC. It should be noted that there are Yamaha models that possess different sequential numbers as well as different prefixes. These instances are rare but do exist.

The following list describes the different models that have been produced. Included in this list are the frame and engine prefixes along with their respective beginning and ending sequential production numbers:

<u>MODEL</u>	<u>YEAR</u>	<u>ENGINE</u>	<u>FRAME</u>	<u>BEGIN.</u>	<u>END</u>
DT100F-W/G	1979	2F5	2F5	050101	
DT125F-B/Y	1979	2N4	2N4	000101	
DT175F-R/S	1979	2N5	2N5	000101	
DT250F	1979	2N6	2N6	000101	
DT100G-R/S	1980	3A3	3A3	000101	
DT125G-S/O	1980	3J0	3J0	000101	
DT175G-R/B	1980	3J1	3J1	000101	
GTMXF	1979	367	367	500101	
GT80F	1979	2F4	2F4	100101	
GT80G	1980	3J8	3J8	000101	
IT175F	1979	2W6	2W6	000101	
IT250F	1979	2X7	2X7	000101	
IT400F	1979	2X8	2X8	000101	
IT125G	1980	3R9	3R9	000101	
IT175G	1980	3R6	3R6	000101	
IT250G	1980	3R7	3R7	000101	
IT425G	1980	3R8	3R8	000101	

<u>MODEL</u>	<u>YEAR</u>	<u>ENGINE</u>	<u>FRAME</u>	<u>BEGIN.</u>	<u>END</u>
LB50PF	1979	2U7	2U7	004101	
LB50PG	1980	2U7	2U7	050101	
LC50G	1980	3L9	3L9	000101	
MX100F	1979	3M1	3M1	000101	
MX175F	1979	3M2	3M2	000101	
MX80G	1980	367	367	600101	
MX100G	1980	3T0	3T0	000101	
MX175G	1980	3M2	3M2	100101	
QT50F	1979	3L5	3L5	700101	
QT50G	1980	3L8	3L8	709501	
RD400F	1979	2V0	2V0	000101	
SR500F-R/B	1979	2J2	2J2	020101	
SR250G-B/R	1980	346	346	000101	
TT500F	1979	1T1	1T1	200101	
TT250G	1980	340	340	000101	
TT500G	1980	1T1	1T1	230101	
XS650F	1979	2F0	2F0	020101	
XS650SF-R	1979	2F0	2F0	150101	
XS650SF-B	1979	2F0	2F0	150101	
XS650-2F	1979	2F0	2F0	250101	
XS750F-BG	1979	1J7	1J7	240101	
XS750F-BU	1979	1J7	1J7	240101	
XS750SF-BG	1979	1J7	1J7	350101	
XS750SF-R	1979	1J7	1J7	350101	
XS750SF-B	1979	1J7	1J7	350101	
XS1100F-R	1979	2H7	2H7	020101	
XS1100F-B	1979	2H7	2H7	020101	
XS1100SF-B	1979	3H3	3H3	000101	
XS1100SF-R	1979	3H3	3H3	000101	
XT500F	1979	1E6	1E6	220101	
XS400G	1980	3F8	3F8	020101	
XS400SG-B	1980	3F9	3F9	000101	
XS400SG-R	1980	3F9	3F9	000101	
SR500G	1980	3H1	3H1	000101	
XS650G	1980	3G0	3G0	000101	
XS650SG-R	1980	2F0	2F0	200101	
XS650SG-B	1980	2F0	2F0	200101	
XJ650G-B	1980	4H7	4H7	000101	
XJ650G-R	1980	4H7	4H7	000101	
XS850G	1980	3J3	3J3	000101	
XS850SG-B	1980	3J2	3J2	000101	
XS850SG-R	1980	3J2	3J2	000101	
XS850LG	1980	4H1	4H1	000001	
XS1100G-S	1980	3H5	3H5	000101	
XS1100G-R	1980	3H5	3H5	000101	
XS1100SG-R	1980	3J6	3J6	000101	

<u>MODEL</u>	<u>YEAR</u>	<u>ENGINE</u>	<u>FRAME</u>	<u>BEGIN.</u>	<u>END</u>
XS1100SG-B	1980	3J6	3J6	000101	
XS1100LG	1980	4H3	4H3	000001	
XT250G-W	1980	3Y1	3Y1	000101	
XT250G-R	1980	3Y1	3Y1	000101	
XT500G	1980	3H6	3H6	000101	
YT125G	1980	3X3	3X3	000101	
YZ80F	1979	2X6	2X6	000101	
YZ100F	1979	2W5	2W5	000101	
YZ125F	1979	2X3	2X3	000101	
YZ250F	1979	2X4	2X4	000101	
YZ400F	1979	2X5	2X5	000101	
YZ50G	1980	3R0	3R0	000101	
YZ80G	1980	3R1	3R1	000101	
YZ100G	1980	3R2	3R2	000101	
YZ125G	1980	3R3	3R3	000101	
YX250G	1980	3R4	3R4	000101	
YZ465G	1980	3R5	3R5	000101	
AS2C	1969	AS2	AS2	000101	005520
AT1	1969	AT1	AT1	100101	119829
AT1M	1969	AT1	AT1	300101	303790
AT1B	1970	AT1	AT1	120101	138890
AT1MB	1970	AT1	AT1	310101	312326
AT1C	1971	AT1	AT1	139101	162879
AT1MX	1971	AT1	AT1	313101	317191
AT2	1972	AT1	AT1	165101	197560
AT2M	1972	AT1	AT1	317101	323520
AT3	1973	AT1	AT1	200101	232651
ATMX	1973	AT1	AT1	325101	336220
CS3-C	1970	CS3	CS3	000101	005980
CS3-B	1971	CS3	CS3	100101	111576
CS5	1972	CS3	CS3	200101	216570
CT-1		CT1	CT1	000101	009740
CT-1B	1970	CT1	CT1	010101	031460
CT-1C		CT1	CT1	032101	060230
				200101	202200
CT2	1972	CT1	CT1	065101	98830
CT3	1973	CT1	CT1	100101	144920
DS6C	1969	DS6	DS6	600101	605498
DS6C	1970	DS6	DS6	51055	55066
DS6B	1970	DS6	DS6	100679	111930
DS7	1972	DS7	DS7	100101	126767
DT1	1969	DT1	DT1	00101	08883
DT-1B	1969	DT1	DT1	15001	42520
DT1S	1969	DT1	DT1	90101	91573
DT-1C	1970	DT1	DT1	50101	66389
DT-1M	1970	DT1	DT1	95101	97218

<u>MODEL</u>	<u>YEAR</u>	<u>ENGINE</u>	<u>FRAME</u>	<u>BEGIN.</u>	<u>END</u>
				20101	45120
DT-1E	1971	DT1F	DT1F	00101	03492
DT1-MX	1971	DT1F	DT1F	90101	93694
DT100A	1974	437	437	000101	023094
DT125A	1974	444	444	000101	019910
DT175A	1974	443	443	000101	025820
DT250A	1974	450	450	000101	031781
DT360A	1974	446	446	000101	027673
DT2	1972	DT1F	DT1F	105101	134781
DT2-MX	1972	DT1F	DT1F	185101	195637
DT3	1973	DT1F	DT1F	135101	165633
GT1	1973	393	393	000101	025690
GTMXA	1974	367	367	100101	110730
GTMX	1973	267	267	000101	017860
GT80A	1974	393	393	100101	117240
G5T	1969	G5	G5	200101	211043
G5S	1969	G5	G5	300101	302100
G6S	1969	G5	G5	310101	314600
G65B	1970	G5	G5	320101	323480
G7S	1972	G5	G5	330101	336540
HS1	1970	HS1	HS1	000101	305970
HS1B	1971	HS1	HS1	307101	309160
HT-1	1970	HT1	HT1	200101	214450
HT-1B	1971	HT1	HT1	215101	229459
HT-1MX	1971	HT1	HT1	000101	023405
JT-1	1971	JT1	JT1	000101	041708
JT-1L	1971	JT1	JT1	200101	211048
JT-2	1972	JT1	JT1	300101	330000
JT-2MX	1972	JT1	JT1	50101	71730
LS2	1972	LS2	LS2	000101	013440
LT2	1972	LT2	LT2	000101	031280
LT2M	1972	LT2	LT2	100101	104430
LT3	1973	LT2	LT2	035101	071760
LTMX	1973	LT2	LT2	105101	113130
L2CM	1967	L2	L2	550001	554939
L5T	1969	L5	L5	000101	015810
LSTA	1969	L5	L5	010101	015810
MG1B	1964	G1	M3	200031	208810
MJ2	1962	J2	M3	800001	800767
MJ2B	1962	J2B	M3	800263	808363
MJ2T	1965	J2B	M3	505678	521732
MX100A	1974	427	427	000101	012030
MX125A	1974	402	402	000101	009220
MX175A	1974	455	455	000101	006305
MX250	1973	364	364	000101	011040
MX250A	1974	364	364	020101	

<u>MODEL</u>	<u>YEAR</u>	<u>ENGINE</u>	<u>FRAME</u>	<u>BEGIN.</u>	<u>END</u>
MX360	1973	365	365	000101	009306
MX360A	1974	365	365	020101	
SC500	1973	363	363	000101	005298
RD200A	1974	397	397	010101	015900
RD250	1973	352	352	100101	108117
RD250A	1974	352	352	200101	211280
RD350	1973	351	351	100101	124870
RD350A	1974	351	351	200101	224734
RD60	1973	388	388	101	002540
RD60A	1974	388	388	003101	006270
RT-1	1970	RT1	RT1	00101	08883
RT-1M	1970	RT1	RT1	50101	97218
RT1B	1971	RT1	RT1	09191	24820

<u>MODEL</u>	<u>YEAR</u>	<u>ENGINE</u>	<u>FRAME</u>	<u>BEGIN.</u>	<u>END</u>
RT1MX	1971	RT1	RT1	53101	55215
RT2	1972	RT1	RT1	100101	124142
RT2-MX	1972	RT1	RT1	185101	191618
RT3	1973	RT1	RT1	125101	150994
R3	1969	R3	R3	00101	06200
R5	1970	R5	R5	000101	013649
R5B	1971	R5	R5	015101	042209
R5C	1972	R5	R5	100101	130606
SC500A	1974	363	363	020101	024183
TA125	1973	AS3	400	990101	
TA125A	1974	AS3	400	990101	
TA250	1973	DS7	TD3	990101	990590
TZ250A	1974	DS7	430	991101	
TZ350	1973	R5	383	991001	
TZ350A	1974	R5	383	991001	
TZO-750A	1974	409	409	000101	
TD-1A	1965	D6	62-T1	001	
TD-1B	1965	D6	T1	127	529
TD-1C	1965	D6	T1	000101	000402
TX500	1973	371	371	000101	013716
TX500A	1974	371	371	100101	
TX650	1973	S650	S650	200101	217100
TX650A	1974	447	447	000101	012150
TX750	1973	341	341	101	022795
TY80A	1974	451	451	000101	012476
TY250A	1974	434	434	000101	015984
U5	65-69	F5	M5	213171	309662
USE	65-69	F5	M5	500291	510879
U5L	1969	F5	M5	520797	521478
U7E	1972	V70	V70	900101	904750
XS1	1970	S650	S650	000101	006686
XS1B	1971	S650	S650	008101	025383
XS2	1972	S650	S650	100101	133900
GS650	1972	GS650	GS650	102651	102850
YAS1C	1969	AS1	AS1	300101	310340
YA5	61-64		Y12	46476	138210
YA6	64-67	A7	Y21	102863	210890
YA6M	68-70	A7	Y21	173001	45540
JCS1	1967	CS1	CS1	00102	18676
YCS1C	1968	CS1	CS1	500101	506520
*YD3		D5	Y13	10001	36000
*YDT1		D5	Y19	55519	59385
*YDS2		D6	F14	1001	16443
*YDS3		D9 or 10	Y23	1001	37577
*YDS3C		D10C	Y23C	1001	16552
YDS5	1968	DS5	DS5	00101	08032

* = VIN and engine sequential may vary.

1976

<u>MODEL</u>	<u>FRAME START</u>	<u>END</u>
DT250C	450500101/505102	
YZ250C	5091000101	509103405
TY250C	493100101	493101209
RD400	1A1000101	1A1017310
DT400C	501200101	501211470
YZ400C	510100101	510102838
XS500C	1J3000101	1J3008500
TT500C	583000101	583006370
KT500C	1E6000101	1E6011360
XS650C	447200101	447211894
KS750D	1J7000101	
1T400C	510200101	510205196
KS360C	169000101	1L9005843
TZ250C	430993101	430993235
TZ750C	409100101	409100140

1977

LB8011AD	1F7100101	1F7101110
GTMXD	367300101	367303100
YZ80D	1T0000101	1T0020290
DT100D	1T9000101	1T9017690
YZ100D	1J4100101	1J4103550
YZ125D	1W1000101	1W1015610
1T175D	1W2000101	1W2010428
YZ250D	1W3000101	1W3006520
DT250D	1M1000101	1M1009399
1T250D	1W5000101	1W5002480
T4250D	493200101	493201551
LB80111D	1T8000101	1T8005610
XS360D	169100101	169103500
XS3602D	1T6000101	1T6007200
RD400D	1A1300101	1A1314824
XS400D	2A2000101	2A200849
DT400D	1M2000101	1M2006493
1T400D	1W6000101	1W6003540
YZ400D	1W4000101	1W4006720
XS500D	1J3100101	1J3102100
KT500D	1E6100101	1E6110250
TT500D	1T1000101	1T1008500
XS650D	447700101	447724061
KS7502D	1J7100101	1J7112320

1977 Cont'd

<u>MODEL</u>	<u>FRAME START</u>	<u>END</u>
TZ250D	430994101	430994481
TZ750D	409200101	409200101

1978

<u>MODEL</u>	<u>FRAME START</u>
LB802AE	2F7000101
RD400E	1A1350101
XS400ER	2L0000101
XS400EB	2L0000101
XS4002E	2G5000101
SR500ER	2J2000101
XS500E	1J3200101
XS650EB	2F0000101
XS750E	1J7220101
XS1100E	2H7000101
GT80E	2F4000101
DT100E	2F5000101
DT125	2A6000101
DT175E	2A7000101
DT250E	1M1100101
DT400E	1M2100101
XT500E	1E6200101
GTMXE	367400101
YZ80E	2J5000101
YZ100E	2K5000101
YZ125E	2K6000101
YZ250E	2K7000101
YZ400E	2K8000101
1T175E	1W2020101
1T250E	2K9000101
1T400E	1W6100101
TT500	1T1100101

YANKEE

(No Longer in Production)

VIN SYSTEM: 9900-019

VIN Location - Stamped into frame at headstock.

Engine Number - M - 262-740

Located on crankcase. Not same as VIN.

Models Produced:

Street Scrambler	-	500cc
Yankee Z	-	500cc
Yankee Z SST	-	500cc

MOTORCYCLE IDENTIFICATION

**A GUIDE TO THE IDENTIFICATION OF ALL MAKES AND MODELS OF
MOTORCYCLES, INCLUDING OFF ROAD MACHINES AND MOPEDS**

**BY
LEE S. COLE**

**LEE BOOKS
PO BOX 906
NOVATO, CA 94948
415-897-3550**

COPYRIGHT 1986

BY

LEE S. COLE

A

LEE BOOK

PRINTED IN THE
UNITED STATES OF AMERICA

ALL RIGHTS RESERVED, INCLUDING THE RIGHT TO
REPRODUCE THIS BOOK, OR ANY PART THEREOF,
IN ANY FORM.

ISBN # 0-939818-11-6



3 9077 01029397 8

ISBN #0-939818-11-6