



STEM.ORG
ACCREDITED[™]
EDUCATIONAL EXPERIENCE ✓



QUICK CONSTRUCTION



MOTORISED GEARBOX



GEAR SYSTEM



2 WAY SWITCH

CRAWLERS

Blix



AGE
8+

PIECES
70+

MODELS
8

Do - it yourself manual

- 1 Read all instructions carefully before constructing.
- 2 Place all the pieces used in a step on the side before starting.
- 3 Always remove batteries when not in use.



How to construct

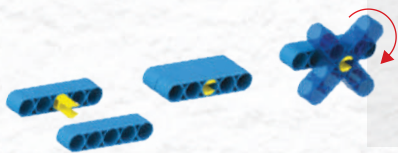

I - CL2 - Use this connector to loosely connect 2 pieces.



II - CT2 - Use this connector to attach 2 pieces.

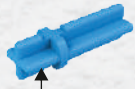

III - CT3 - Use this connector to attach 3 pieces.



During assembly ensure position of collar is same as in the image in manual.

How to dismantle

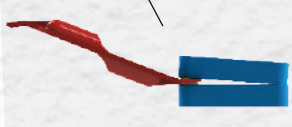
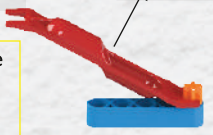

- Narrow edge to remove connectors
- Fit the tool into narrow side of connector collar

- Broad edge to split two pieces

Safety Guidelines

- Do not mix old and new batteries.
- Do not mix alkaline, standard (Carbon-Zinc) or rechargeable (Nickel-Cadmium) batteries.
- Batteries are to be inserted by matching (+) and (-) polarity markings as shown in the image.
- Non-rechargeable batteries are not to be charged.
- Rechargeable batteries are to be removed before being charged.
- Exhausted batteries are to be removed from toy.
- The supply terminals are not to be short-circuited.
- The kit is not intended for children under 3 years old.
- Remove batteries before cleaning any part of the toy.
- Prevent wire from coming in contact with the wheels and tracks, by using wire clip.

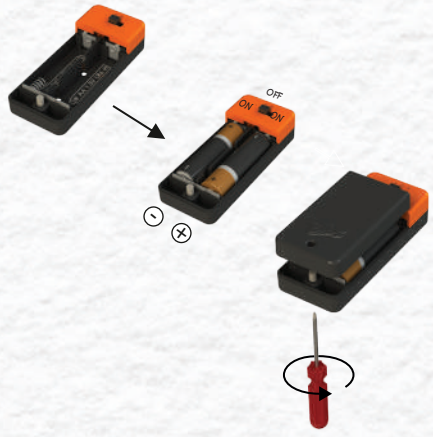

Add 2 x 1.5 V AA size batteries

MODEL-1

Step - 1

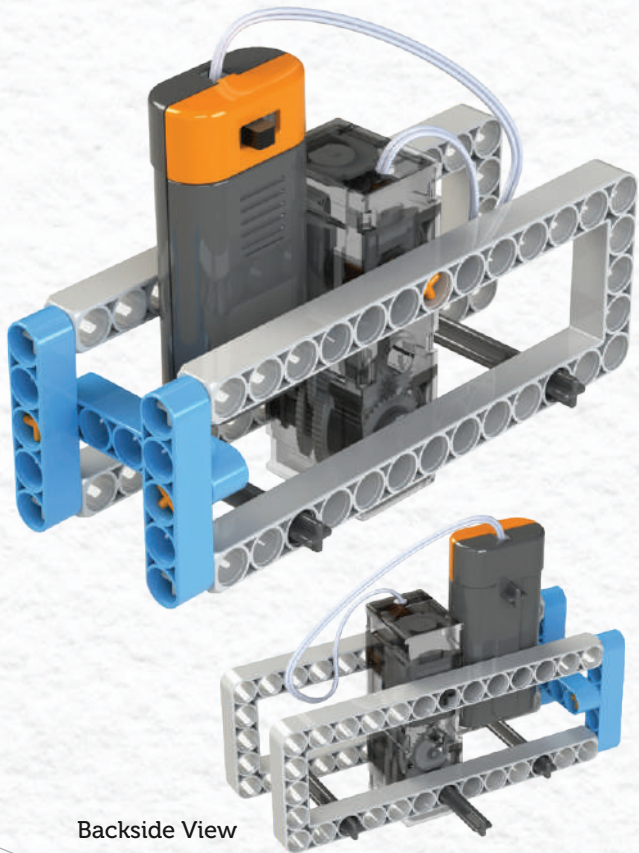
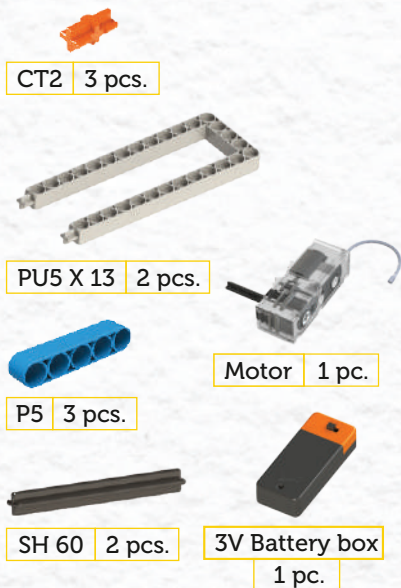

Step - 2

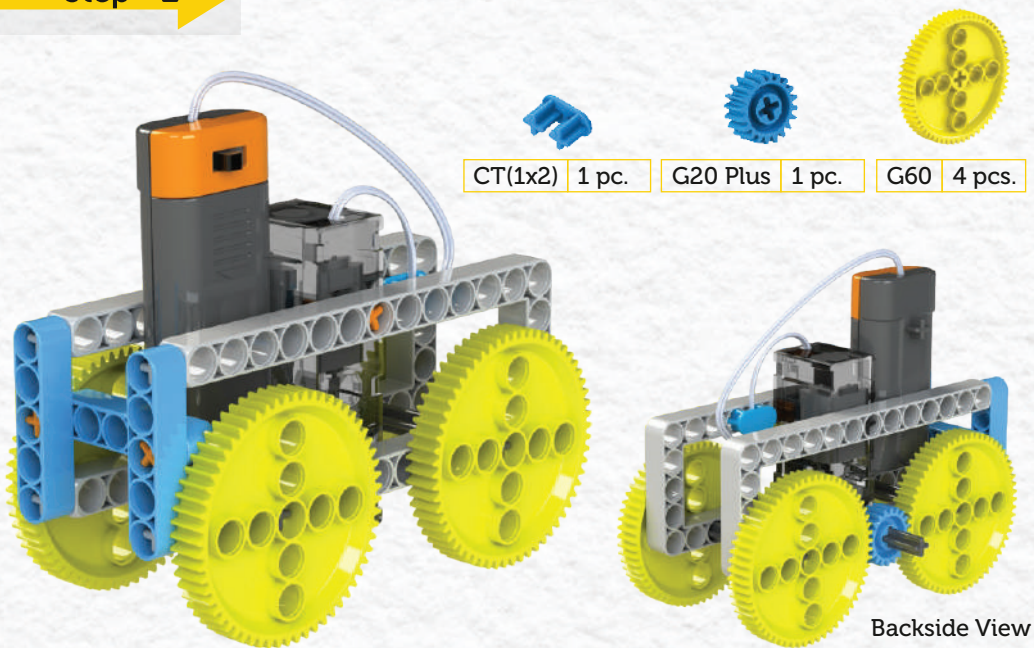

Step 3



CL2 8 pcs.



CH2 2 pcs.



CT2 2 pcs.

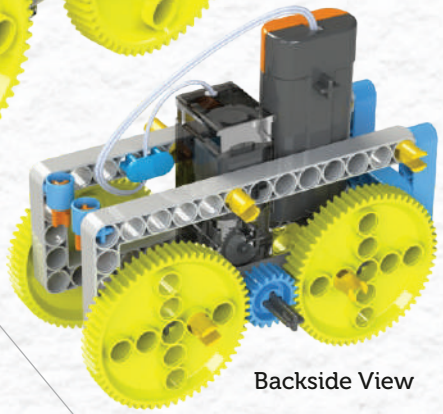
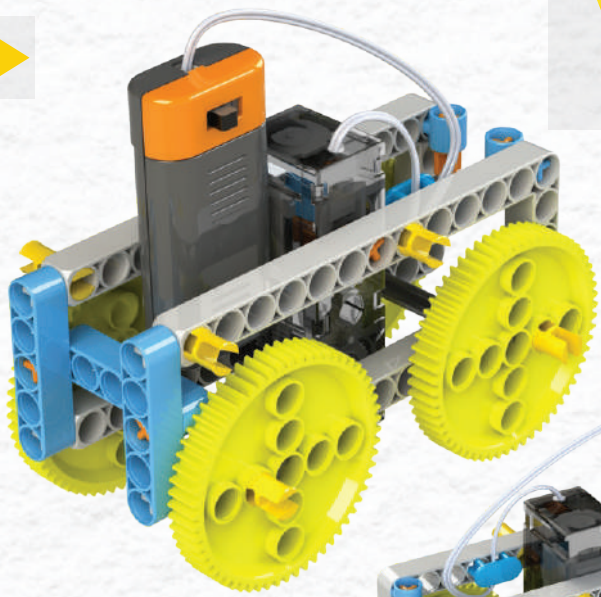

Backside View

Step 4

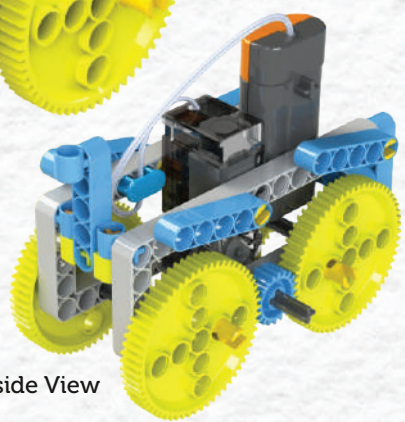
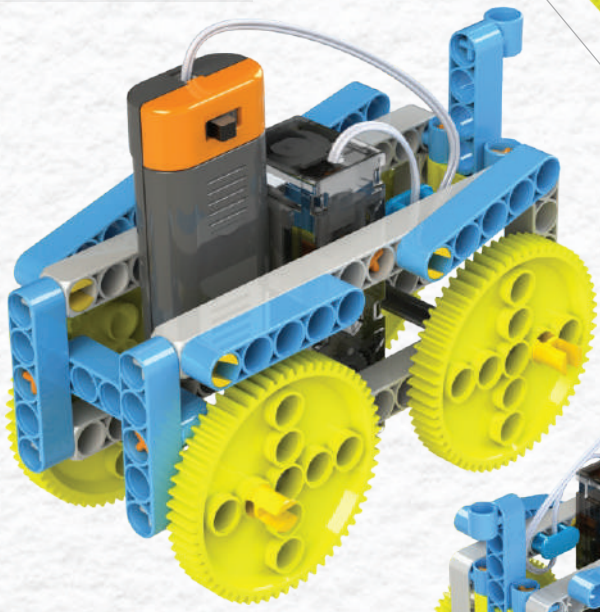

Backside View

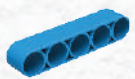

P5 5 pcs.



PC3 1 pc.



CH2 1 pc.

Step 5

CL2 4 pcs.

PC3 1 pc.

P11 4 pcs.

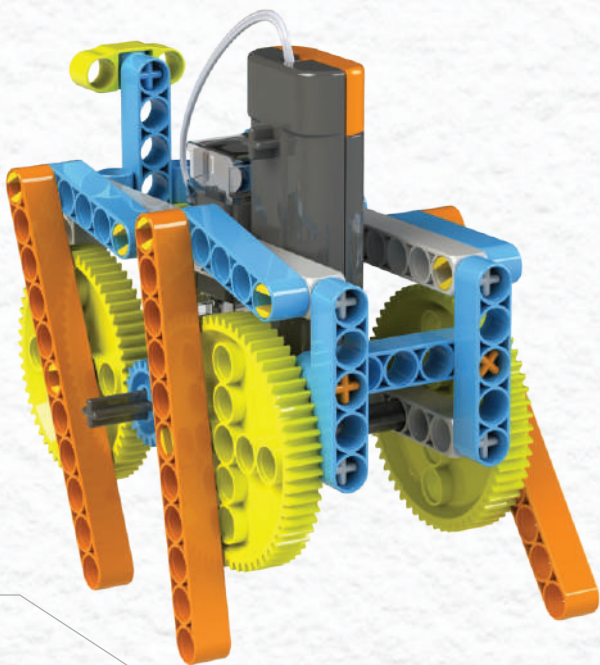

Step 6

CL2 2 pcs.

P3 Plus 2 pcs.

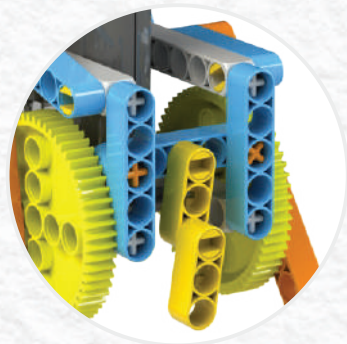
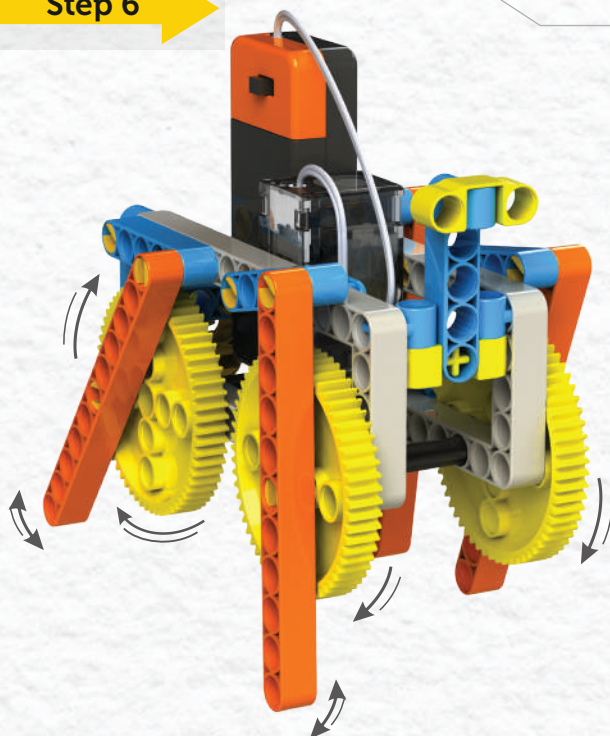

Backside View

MODEL-2



Step - 1

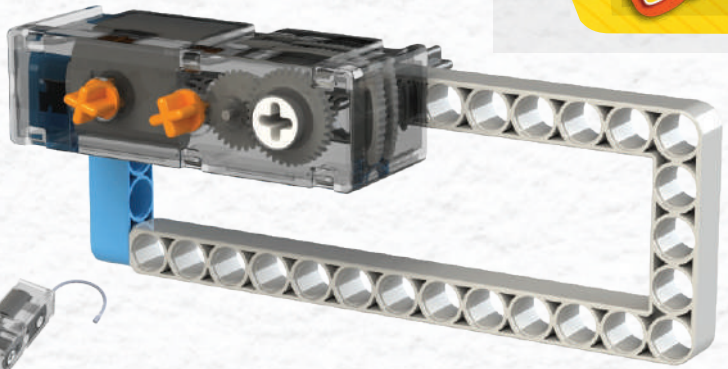

CT2 2 pcs.



P5 1 pc.



Motor 1 pc.



PU5 X 13 1 pc.



3V Battery box
1 pc.

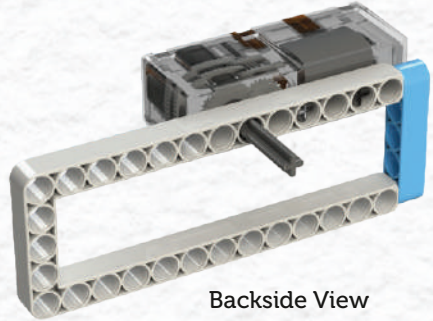

Backside View

Step - 2

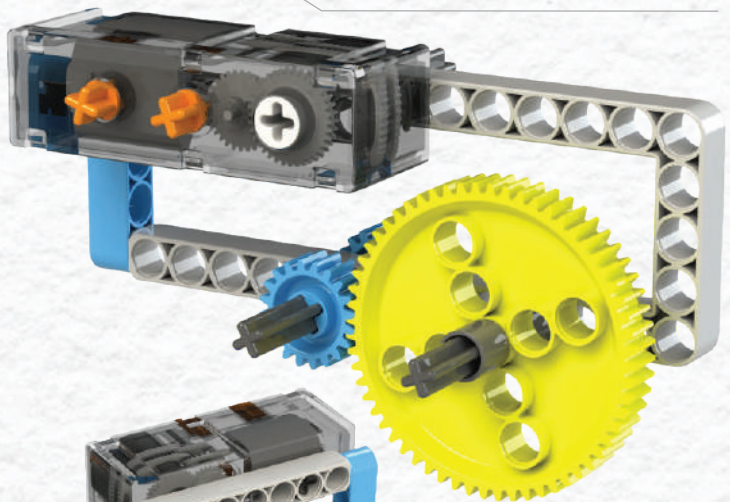

TW1 3 pcs.



G20 Plus 2 pcs.



G60 1 pc.



SH 60 2 pcs.

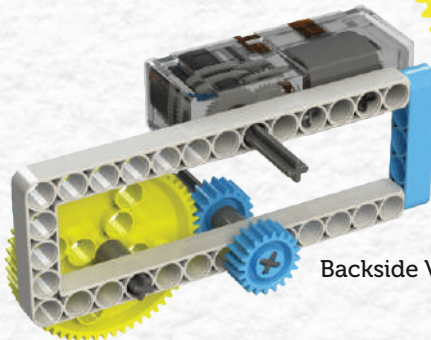

Backside View

Step 3



CL2 2 pcs.



P5 2 pcs.



G60 2 pcs.



SH 60 1 pc.



PU5 X 13 1 pc.

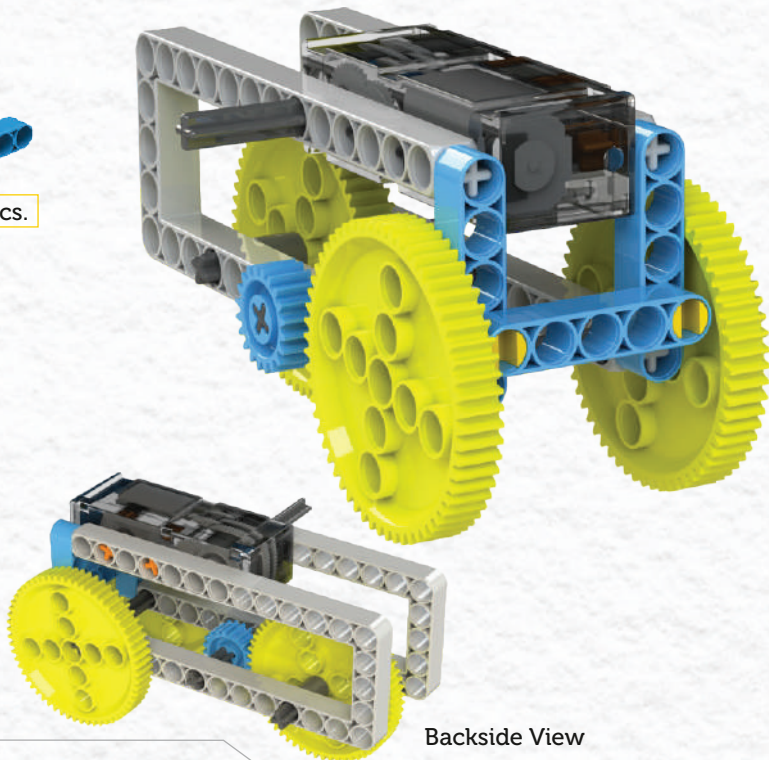

Backside View

Step 4



CL2 4 pcs.



P3 Plus 2 pcs.

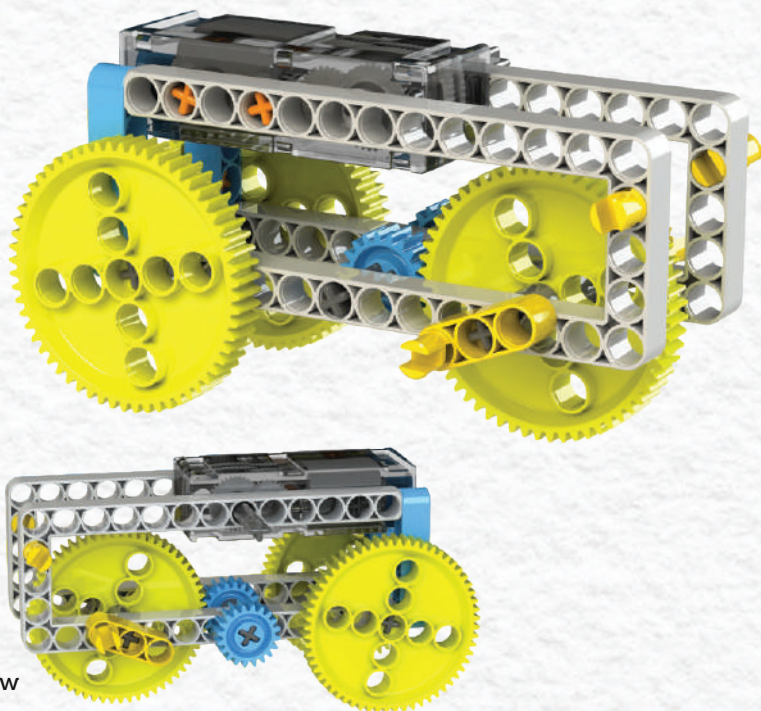

Backside View

Step 5

Blix

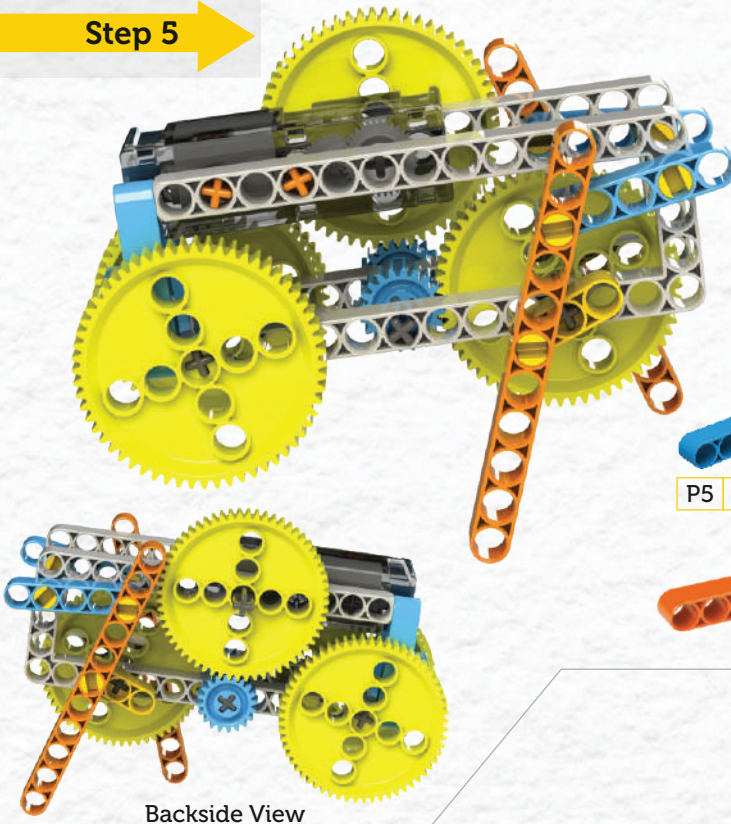

Backside View

CL2 2 pcs.

P5 2 pcs.

G60 1 pc.

P11 2 pcs.

Step 6

CT2 4 pcs.

CT(1x2) 1 pc.

P5 2 pcs.

Rubber Band
2 pcs.

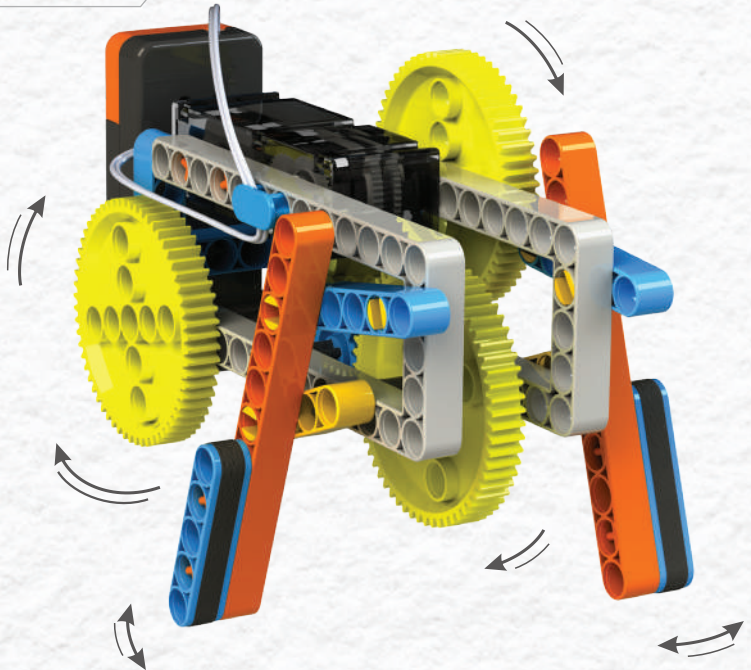

MODEL-3

Step - 1

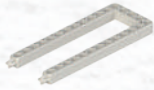

PU5 X 13 2 pcs.



Motor 1 pc.



CT2 1 pc.



CH2 2 pcs.

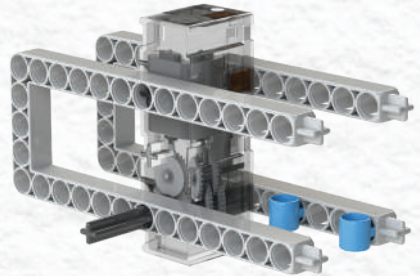
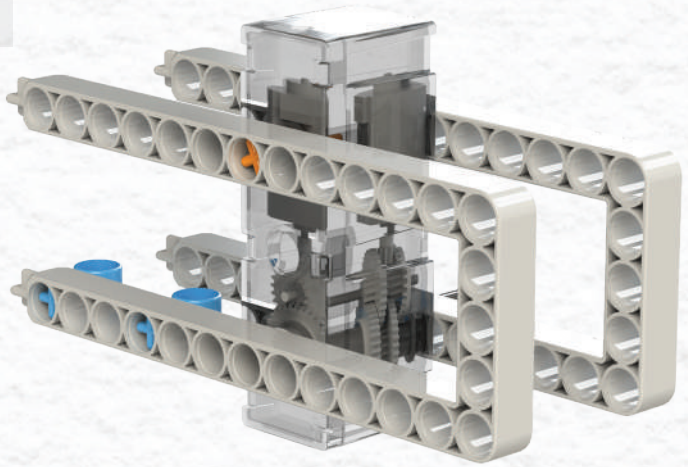

Step - 2



G(20) 1 pc.



G60 4 pcs.



SH60 2 pcs.

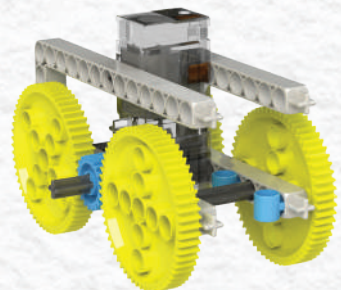
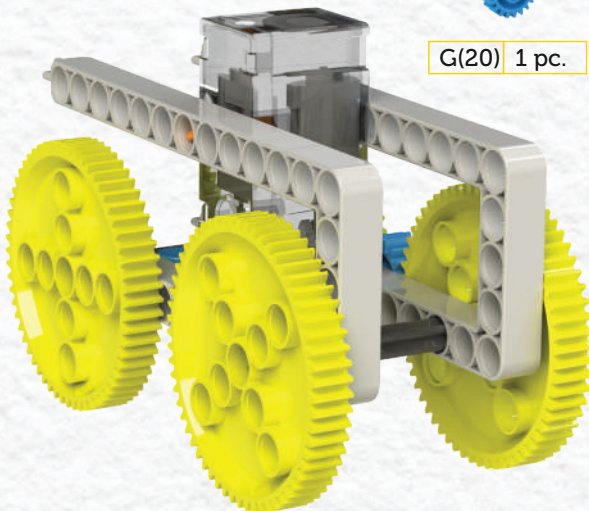

Backside View

Step 3

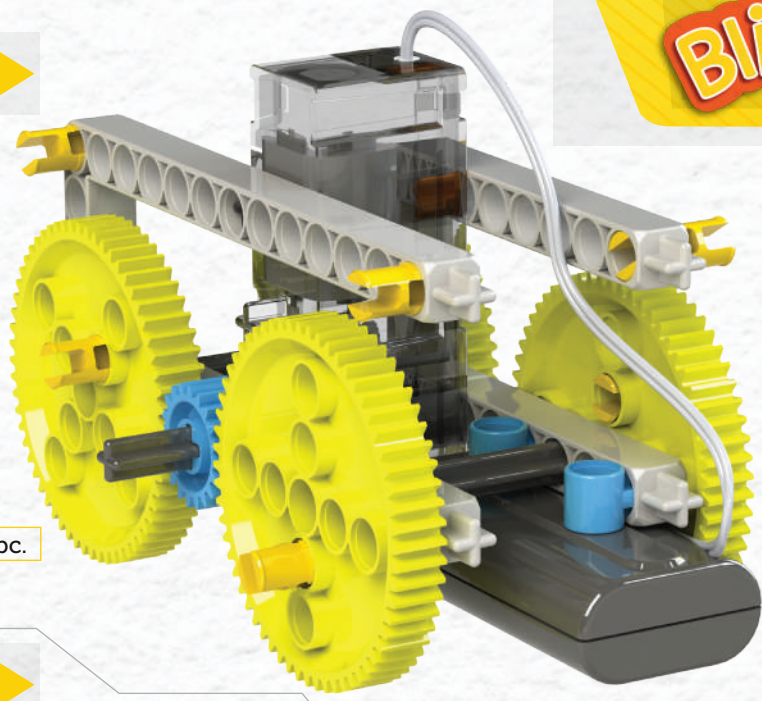

CL2 8 pcs.

3V Battery Box 1 pc.

Step 4

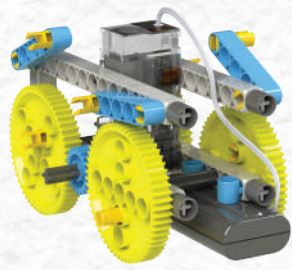

Backside View

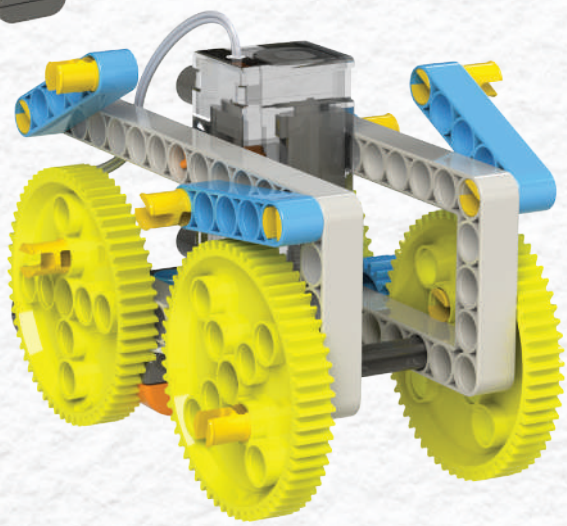

P5 4 pcs.

CL2 4 pcs.

TW1 4 pcs.

Step - 5



P11 4 pcs.



CT2 4 pcs.



P5 4 pcs.

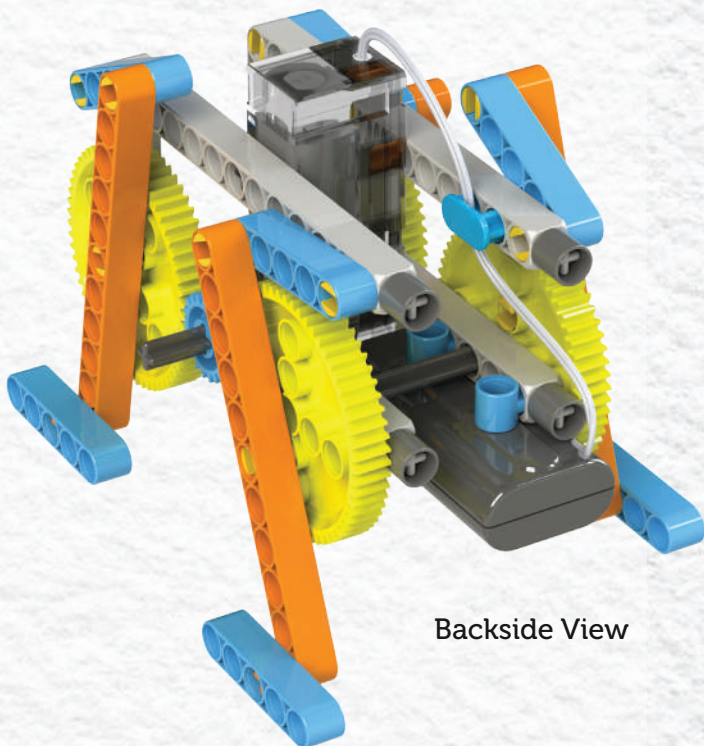
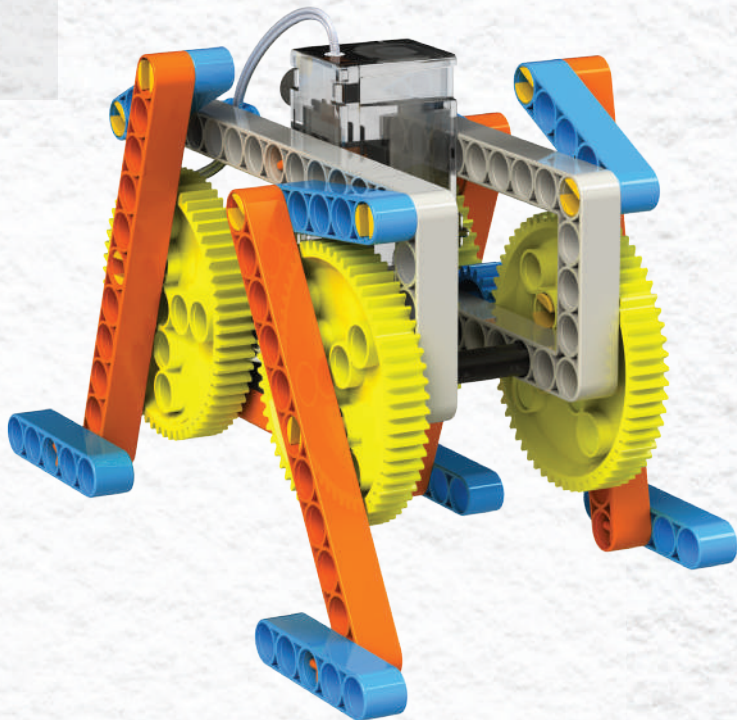

Backside View

MODEL-4



Step 1



CT2 6 pcs.



CH2 2 pcs.



PU5 X 13 2 pcs.



P3 Plus 1 pc.



G(20) 1 pc.



TW1 2 pcs.



SH60 3 pcs.

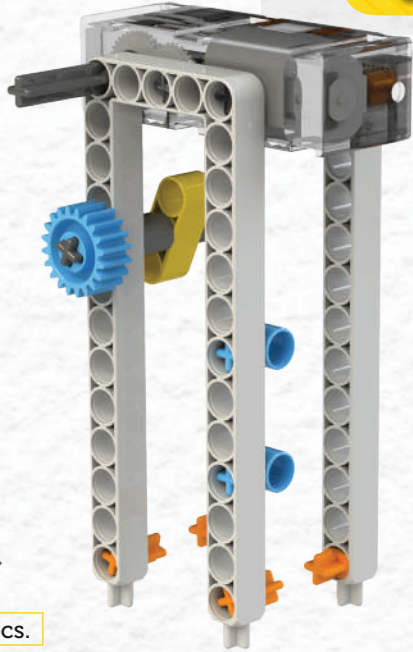

Step 2



P11 2 pcs.



SH60 1 pc.



G(20) 1 pc.

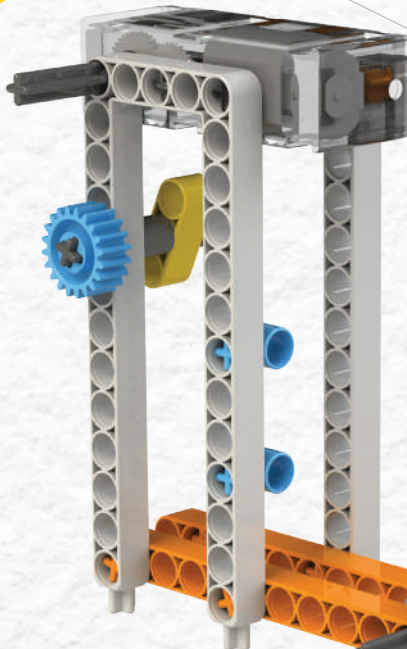

Backside View

Step - 3



G60 3 pcs.



SH60 1 pc.

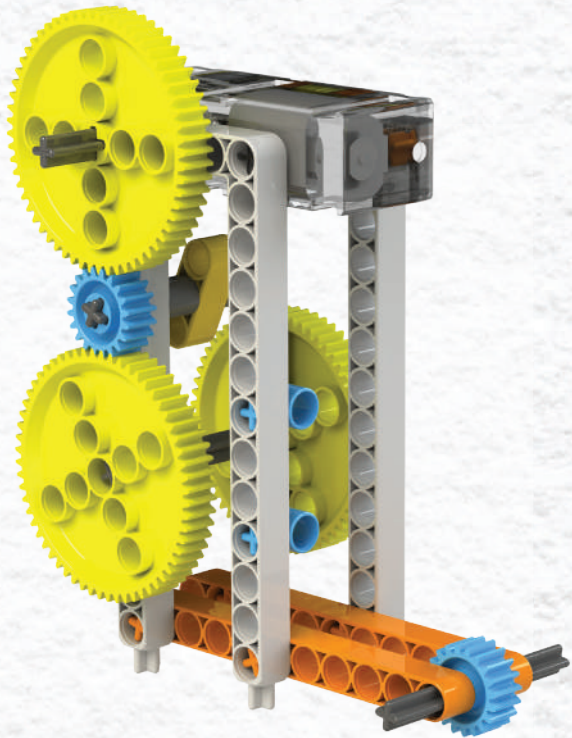

Step - 4



CL2 2 pcs.

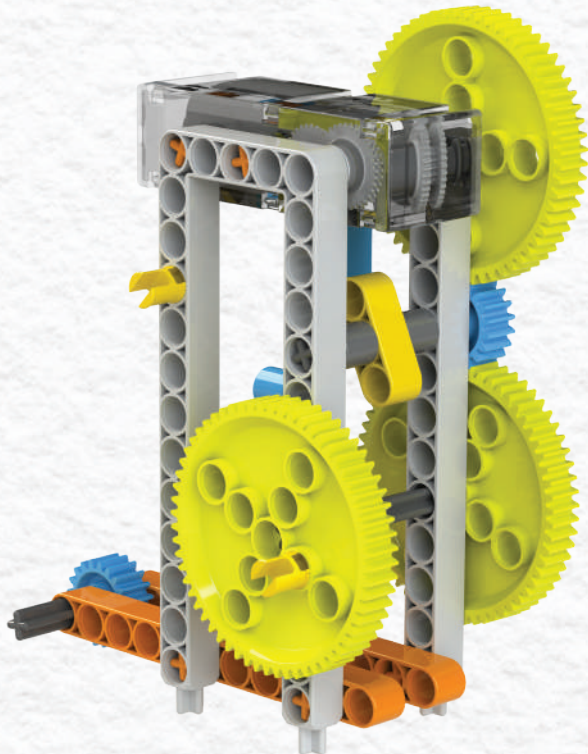

Step - 5



CT2 2 pcs.



CL2 6 pcs.



P5 4 pcs.



P11 2 pcs.



CT1 X 2 1 pc.

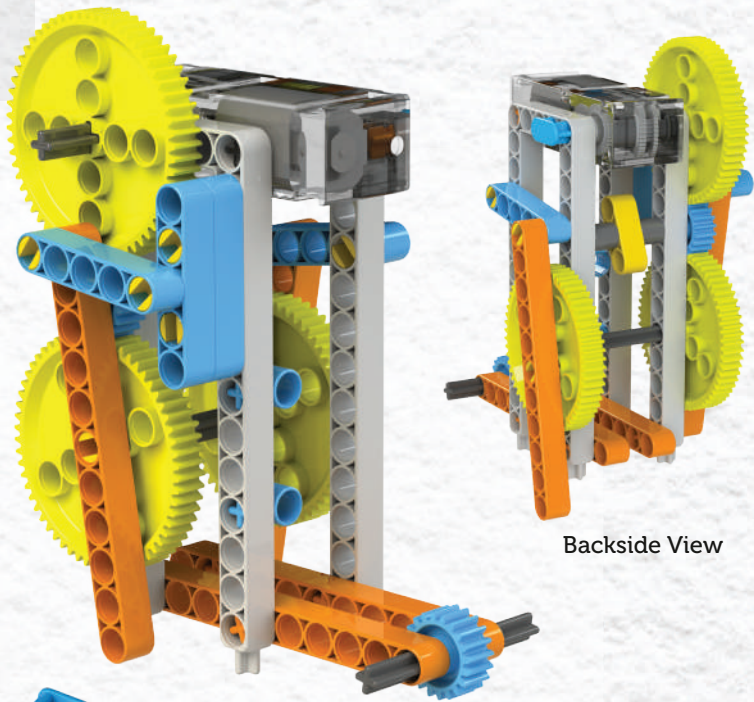

Backside View

Step - 6



P5 4 pcs.



CL2 4 pcs.



Rubber Band 2 pcs.



3v Battery box 1 pc.

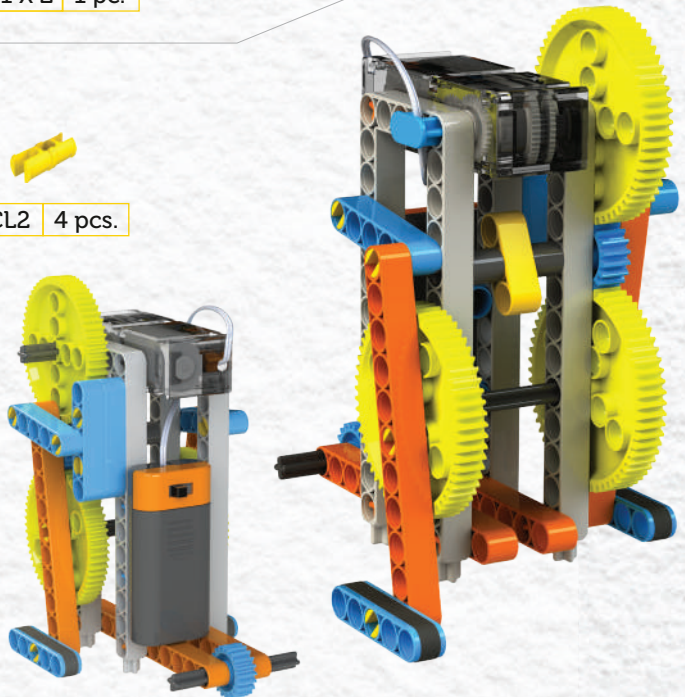

Backside View

MODEL-5

Step - 1



CT2 1 pc.



PU5 X 13 1 pc.



Motor 1 pc.

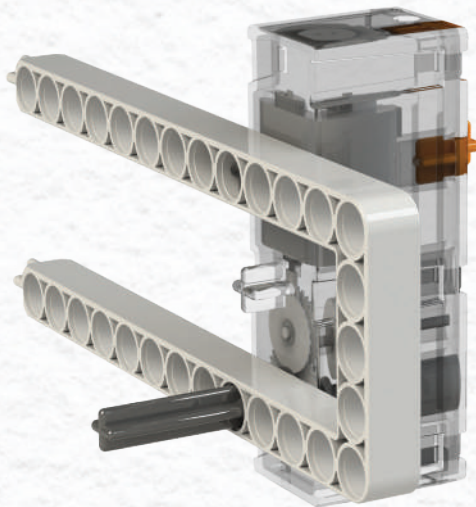

Step - 2



PU5 X 13 1 pc.



SH60 3 pcs.



G(20) 2 pcs.



G60 4 pcs.



3V Battery box
1 pc.

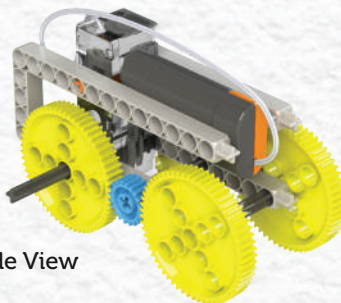
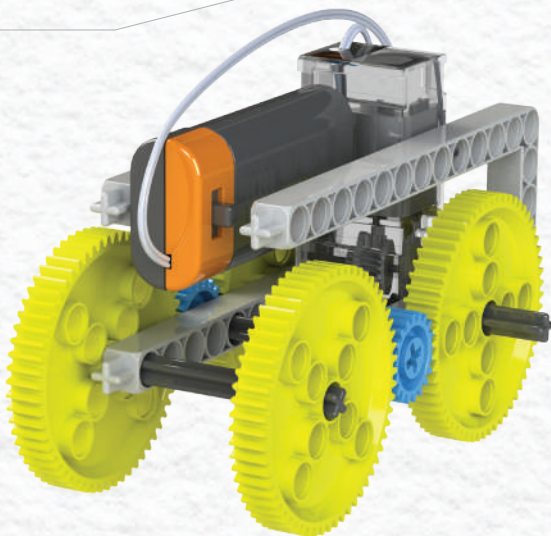

Backside View

Step 3

CL2 4 pcs.

CT1 X 2 1 pc.

P5 4 pcs.

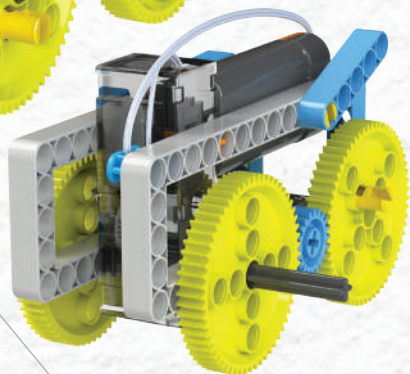
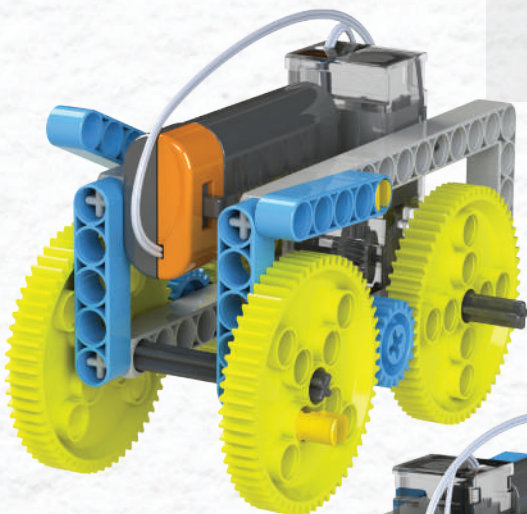

Backside View

Step 4

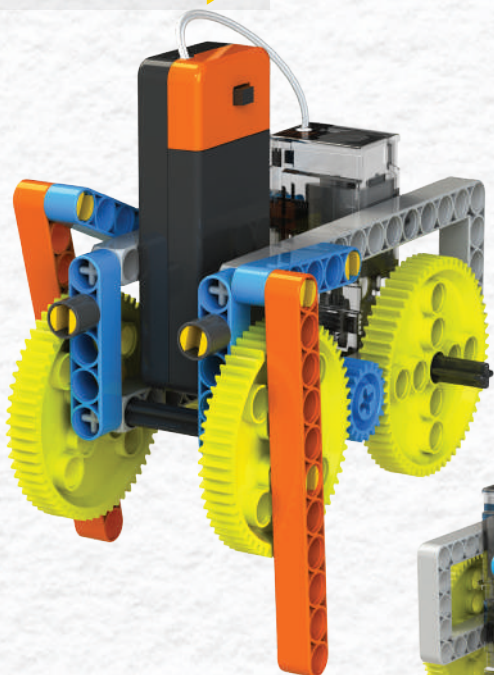

P11 2 pcs.

CL2 2 pcs.

TW1 2 pcs.

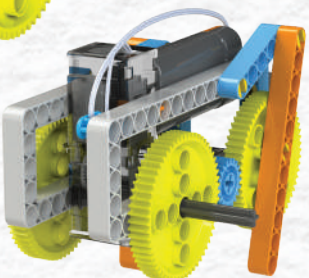
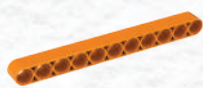

Backside View

MODEL-6

Step - 1



PU5 X 13 1 pc.



CT2 4 pcs.



CH2 2 pcs.



CL2 2 pcs.



P5 3 pcs.



PC3 2 pcs.

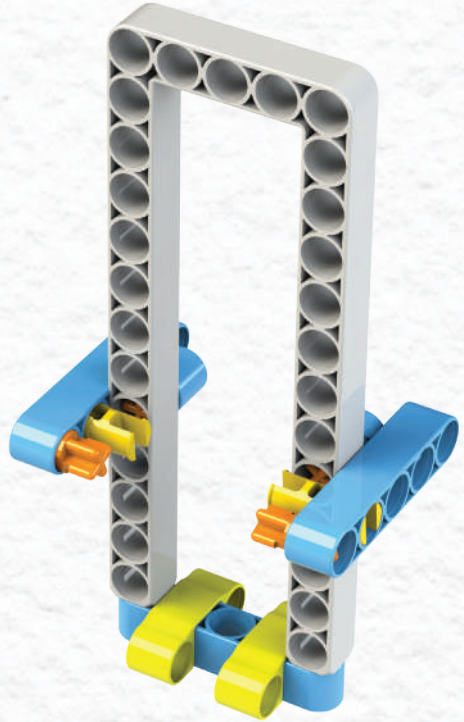

Step - 2

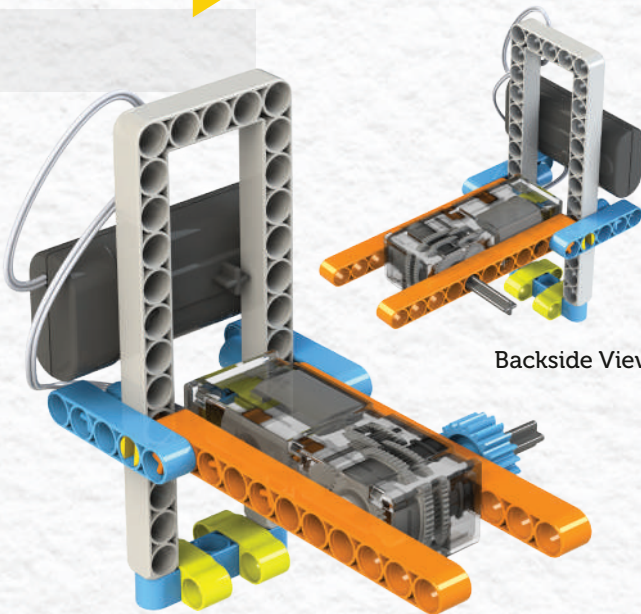

Backside View



CT2 2 pcs.



G(20) 1 pc.



P11 2 pcs.



Motor 1 pc.



3V Battery box
1 pc.

Step 3



SH60 2 pcs.



G60 4 pcs.

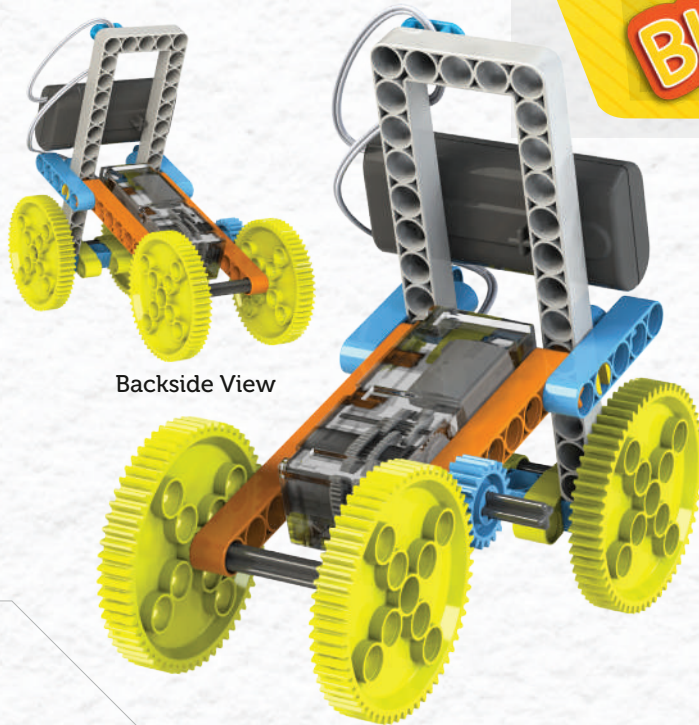

Step 4



P5 2 pcs.



CL2 4 pcs.

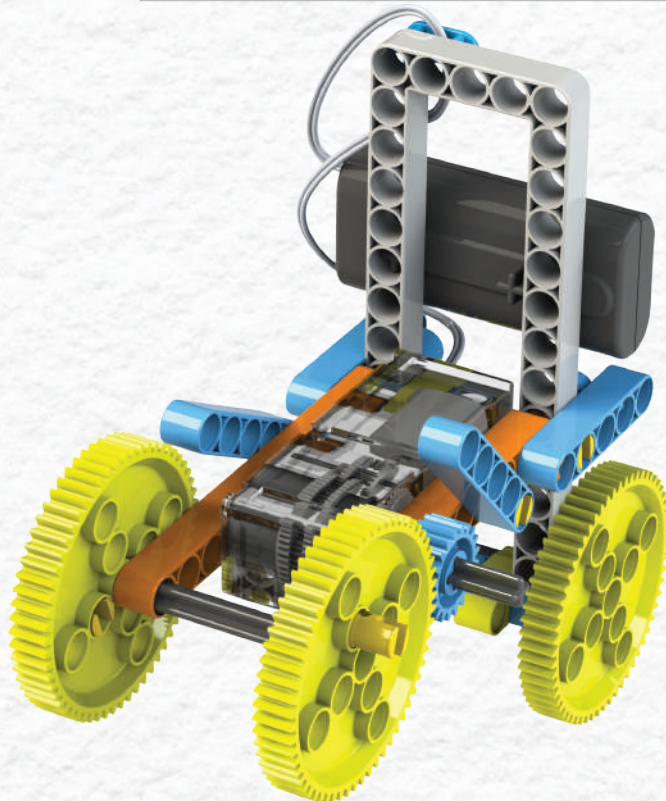

Step - 5



CL2 4 pcs.



Rubber band 2 pcs.



P11 2 pcs.



P5 2 pcs.

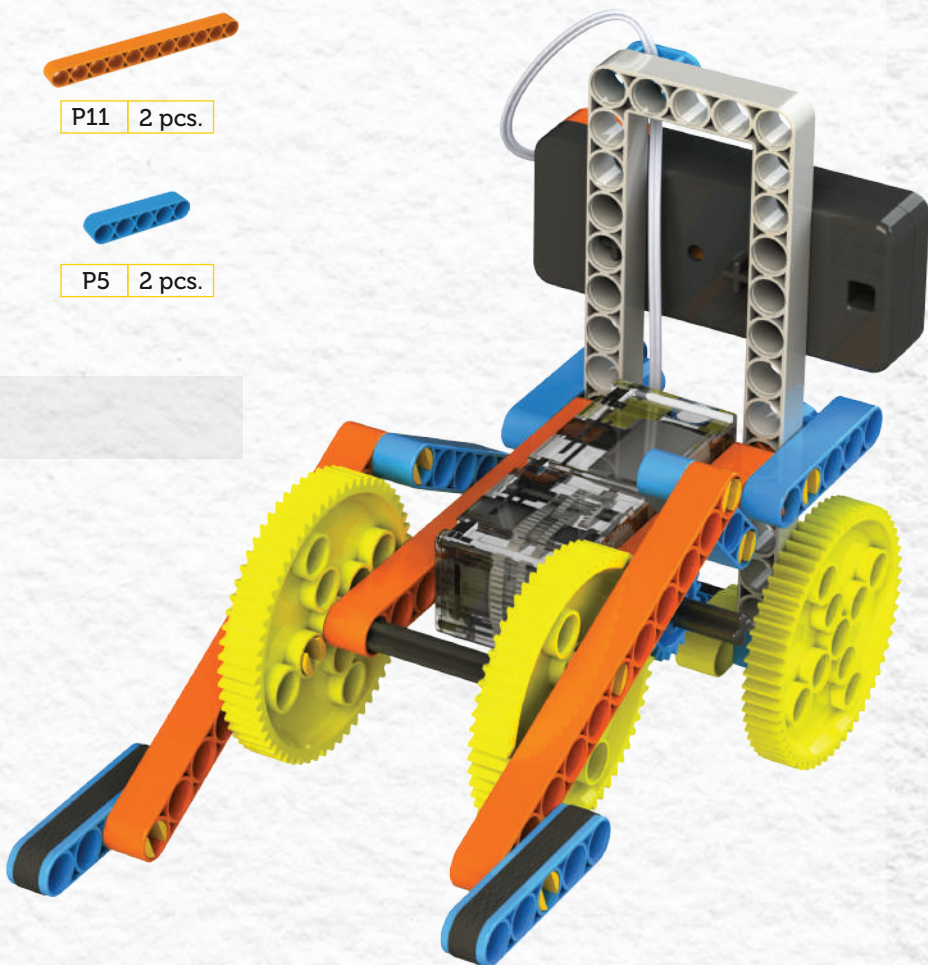

MODEL-7

Blix

Step 1



PU5 X 13 1 pc.



CT2 2 pcs.



CH2 2 pcs.



Motor 1 pc.



Step 2

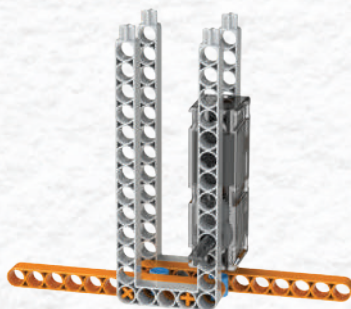
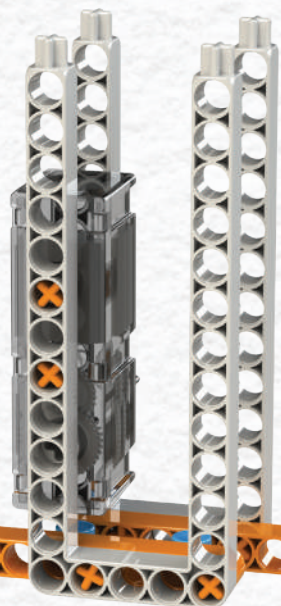

Backside View



CT2 4 pcs.

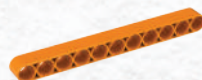

P11 1 pc.



PU5 X 13 1 pc.

Step - 3



G(20) 1 pc.



SH60 1 pc.



G60 2 pcs.

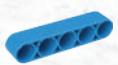

P5 2 pcs.

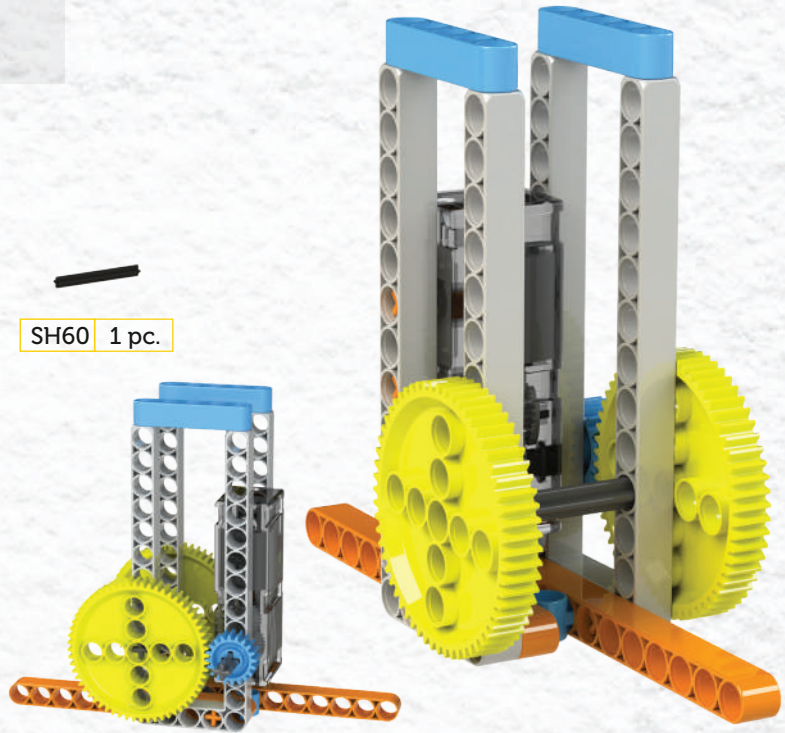

Backside View

Step - 4

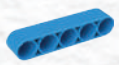

P5 2 pcs.



CL2 4 pcs.

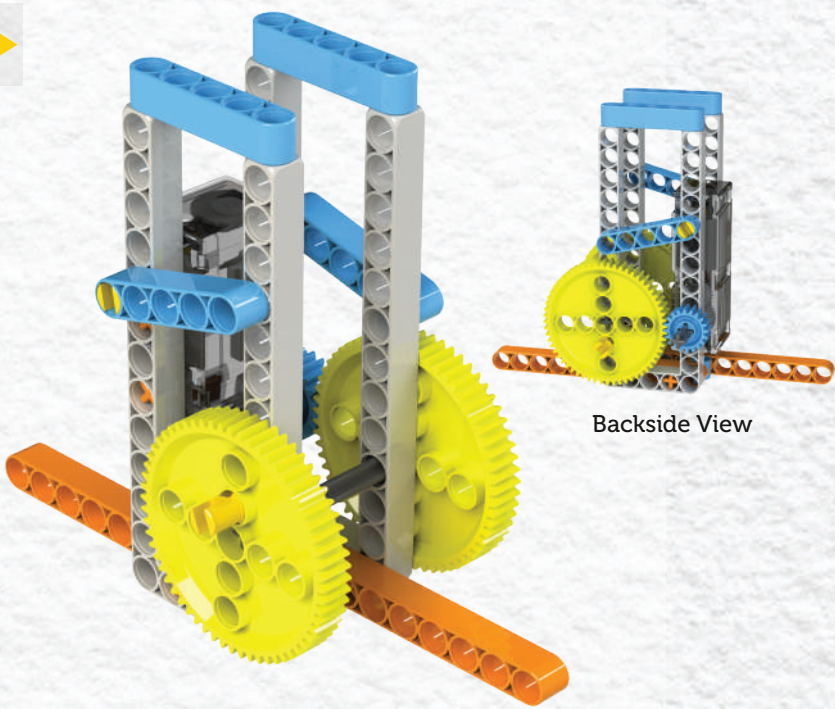

Backside View

Step - 5



CL2 4 pcs.



P11 2 pcs.



SH60 2 pcs.



P3 Plus 2 pcs.

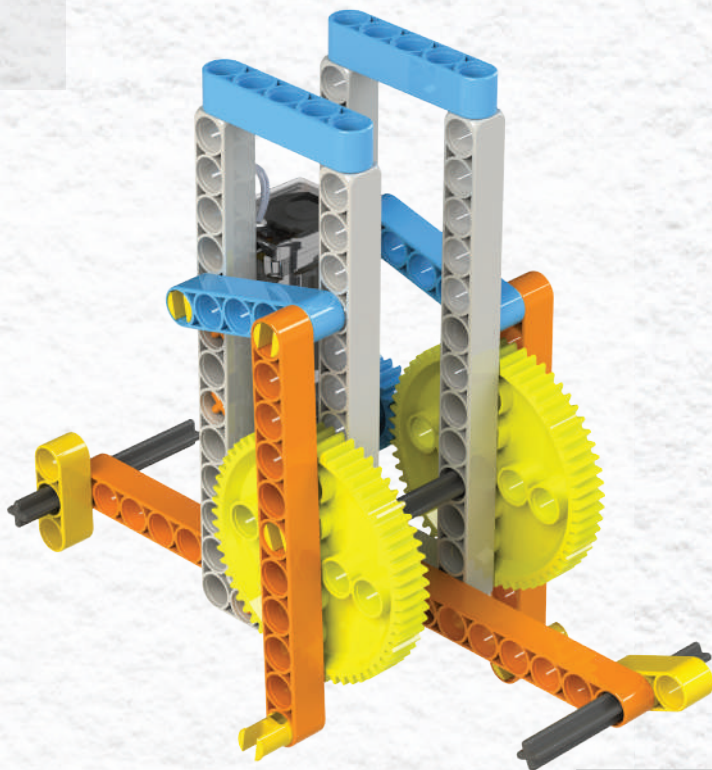

Step - 6



Rubber band 2 pcs.



3V Battery box
1 pc.



G60 2 pcs.



P5 2 pcs.

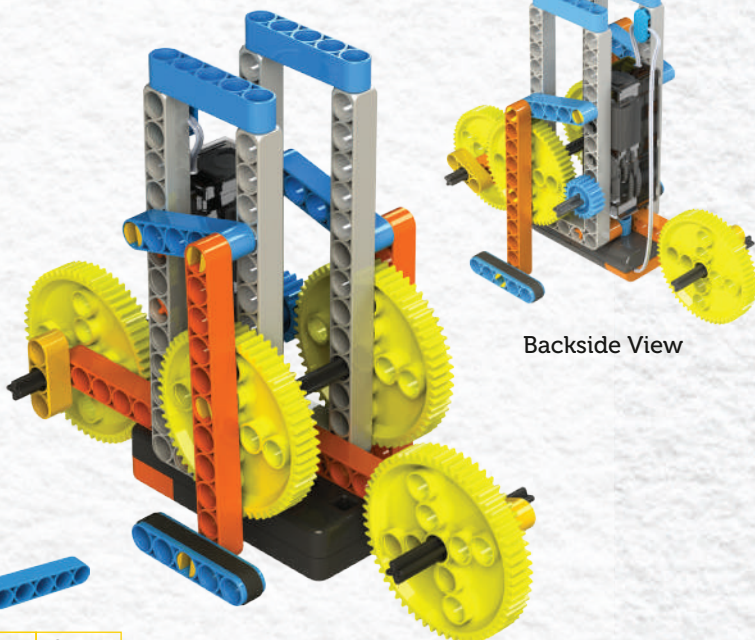

Backside View

MODEL-8

Step - 1



PU5 X 13 2 pcs.



P5 2 pcs.



Motor 1 pc.



CT2 1 pc.



3V Battery box
1 pc.

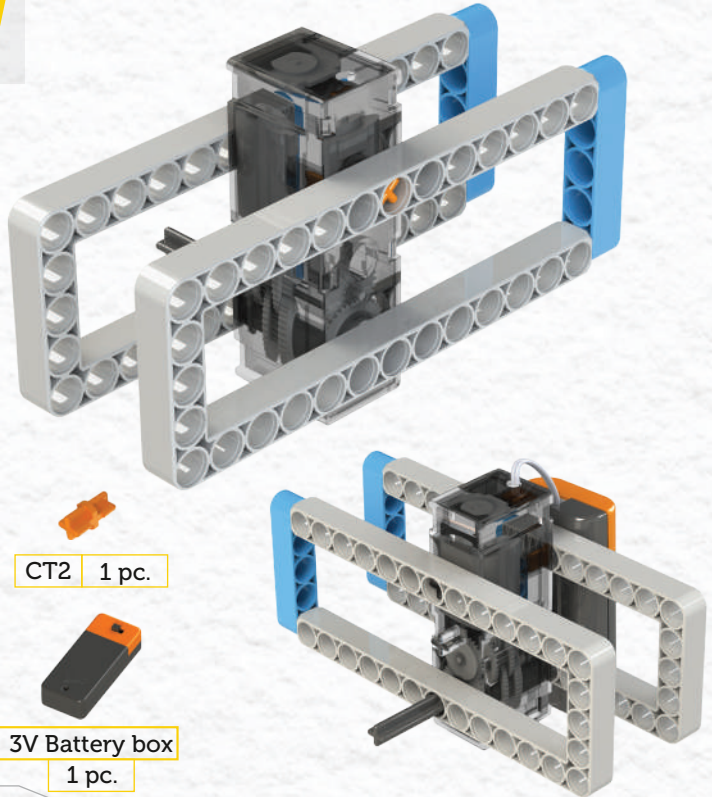

Backside View

Step - 2

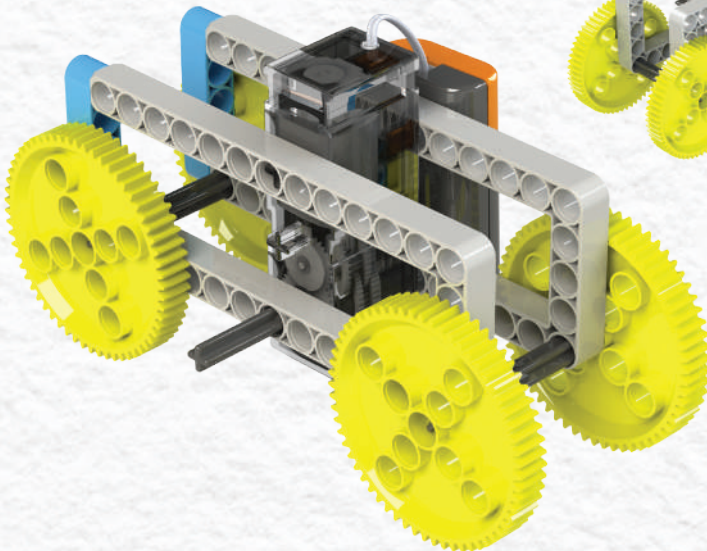

Backside View

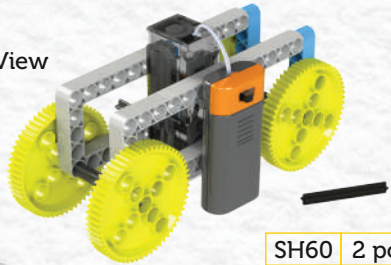

SH60 2 pcs.



G60 4 pcs.

Step 3



CL2 8 pcs.

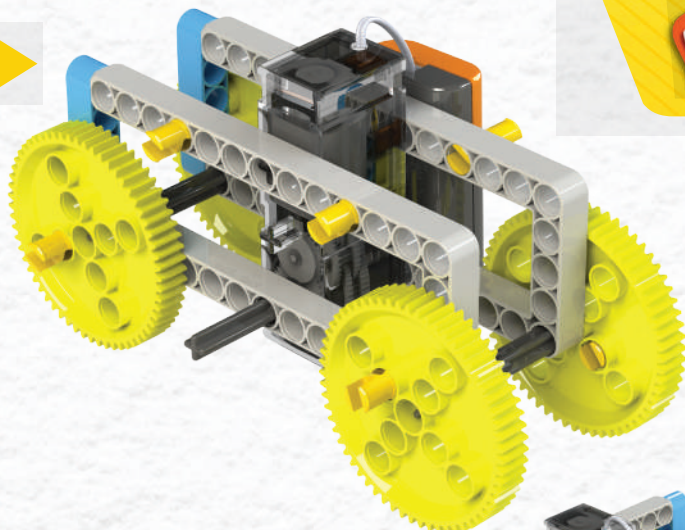

Backside View

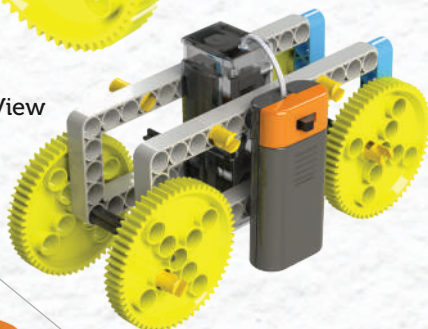

Step 4

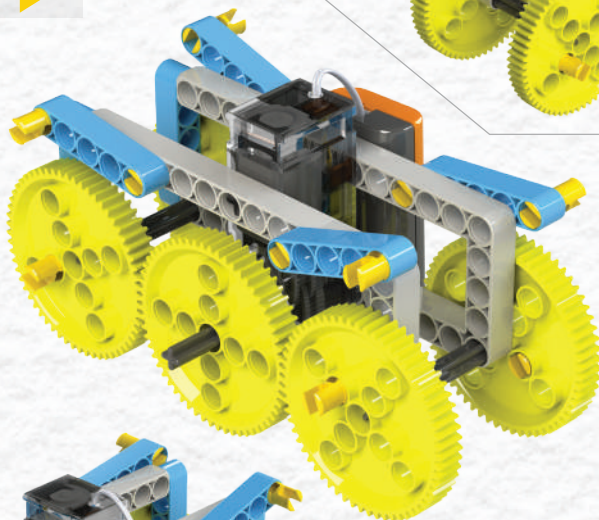

P5 4 pcs.



CL2 4 pcs.



G60 1 pc.

Backside View

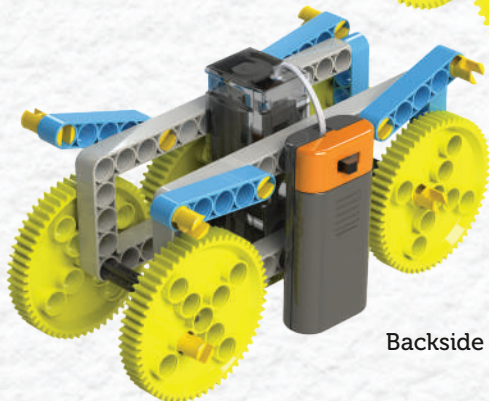

Step - 5

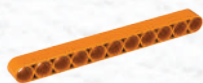

P11 4 pcs.

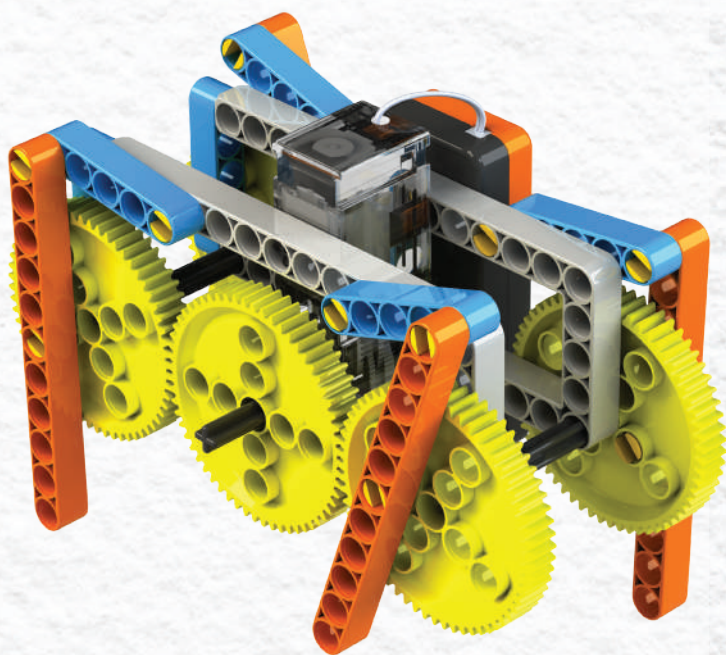

Blix™

CRAWLERS



TW1 7 pcs.



CL2 17 pcs.



CH2 6 pcs.



CT2 10 pcs.



G20 Plus 2 pcs.



CT(1x2) 1 pc.



P3 Plus 2 pcs.



PC3 2 pcs.



G60 5 pcs.



P5 8 pcs.



SH 60 3 pcs.



PU5 X 13 2 pcs.



Rubber Band
2 pcs.



Removal Tool 1 pc.



P11 4 pcs.

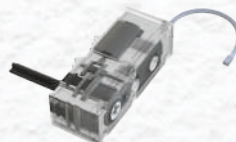

Motor 1 pc.



3V Battery Box 1 pc.



BLIX EDUCATION PRIVATE LIMITED

Ansa Indl.Premi. Coop. SOC.Ltd,Saki Vihar Road,Sakinaka,
Andheri East - 400072, Mumbai

Call : +91 86579 84770

E-Mail: contact@blix.in

Website: <https://blix.in>