

ZEPHYR

More Than Just Play

POWER SCREW

Blix

QUICK
CONSTRUCTION

MOTORIZED
GEARBOX

POWER SCREW
MECHANISM

2 WAY
SWITCH



AGE

7-99

PIECES

208

MODELS

7

Do - it yourself manual

- 1 Read all instructions carefully before constructing.
- 2 Place all the pieces used in a step on the side before starting.
- 3 Always remove batteries when not in use.

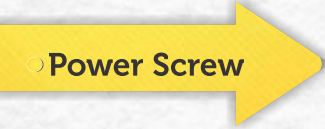

○ Power Screw

If you have noticed a motor running, you must have realized that the Shaft of the motor rotates in a circular motion (rotary motion). But in some applications and machines, we need motion in a Straight line (linear motion) rather than rotation.

For this purpose we have to use a mechanism to convert the rotary Motion of the motor into linear motion required by the machine. A few examples of mechanisms that can be used for this purpose are power screws, rack and pinions, wheel and axles, cams etc.



○ Why use Power Screw?

● Mechanical Advantage

The motor has some power with which it rotates. But when you have to carry luggage into a plane, or have to lift the carriage in a dumper truck, the motor is not strong enough to lift that load.

A power screw is a mechanism that converts the low power of the motor into high powered output which can be used to lift heavy loads. A thing to note is that the speed of the motor seems much faster than the distance travelled by the P5 Nut.

This amplification of force is called Mechanical Advantage.

How It Works

There are 2 components in a Power screw mechanism,

- 1. The Screw
- 2. The Nut.

The screw is attached to the input (in this case the motor), and the nut is fitted on the screw with a constraint to ensure the nut doesn't rotate. In our case, we attach the P5 Nut to either a P11 or base plate.

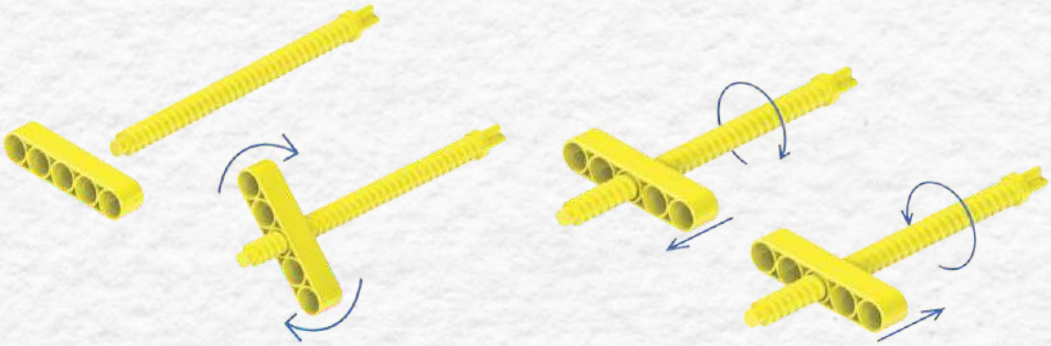

Now when the motor rotates, the nut moves forward or back depending on the direction of rotation.

- Calculations:

Pitch of power screw (Distance between 2 teeth) = 3mm.

With every full circle of the motor, the nut moves just 3mm ahead.

Therefore, assuming the motor is rotating at 100 RPM (Rotations per Minute), the nut moves 300 mm in a minute (about 30 cm/minute) which seems very slow. But the advantage of Power screw is that what it loses in speed, it converts into force.



How to Construct



I - CL2- Use this Connector to loosely connect 2 pieces.

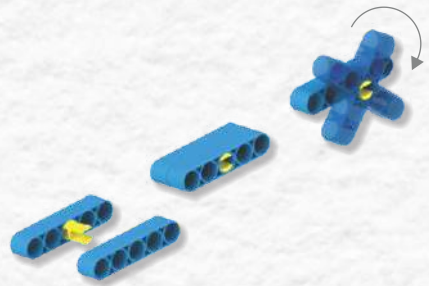

III - CT2 - Use this Connector to attach 2 pieces.



II - CT3 - Use this Connector to attach 3 pieces.

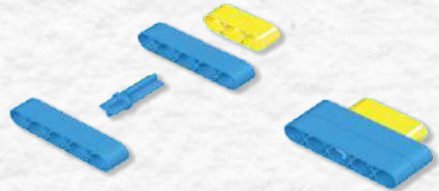

During assembly ensure position of collar is same as in the image in manual.

How to Dismantle

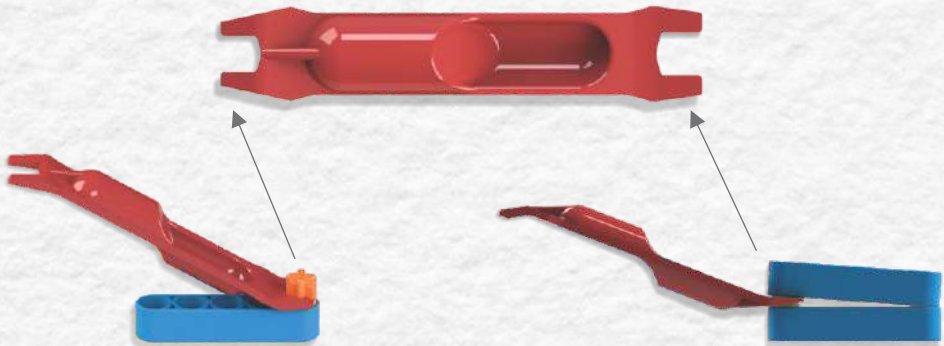

- Narrow edge to remove connectors
- Fit the tool into narrow side of connector collar

- Broad edge to split two pieces

Step - 1



CH2 4 pcs.



CT2 2 pcs.



Motor 1 pc.

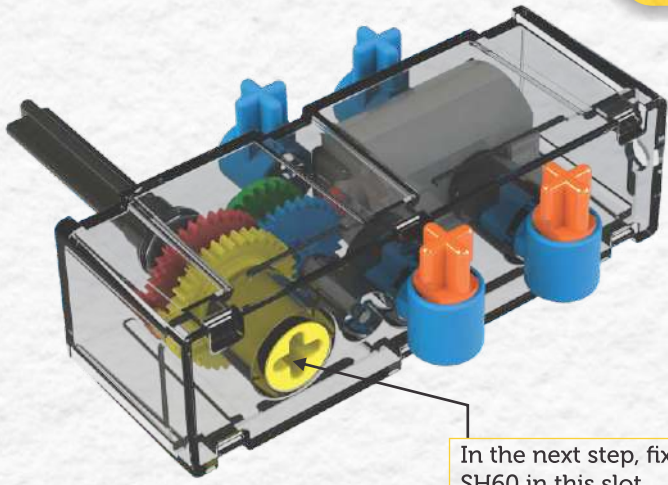

In the next step, fix SH60 in this slot.

Step - 2



P11 2 pcs.



CT3 4 pcs.



CH2 2 pcs.



TW1 4 pcs.



SH60 1 pc.



SH100 1 pc.

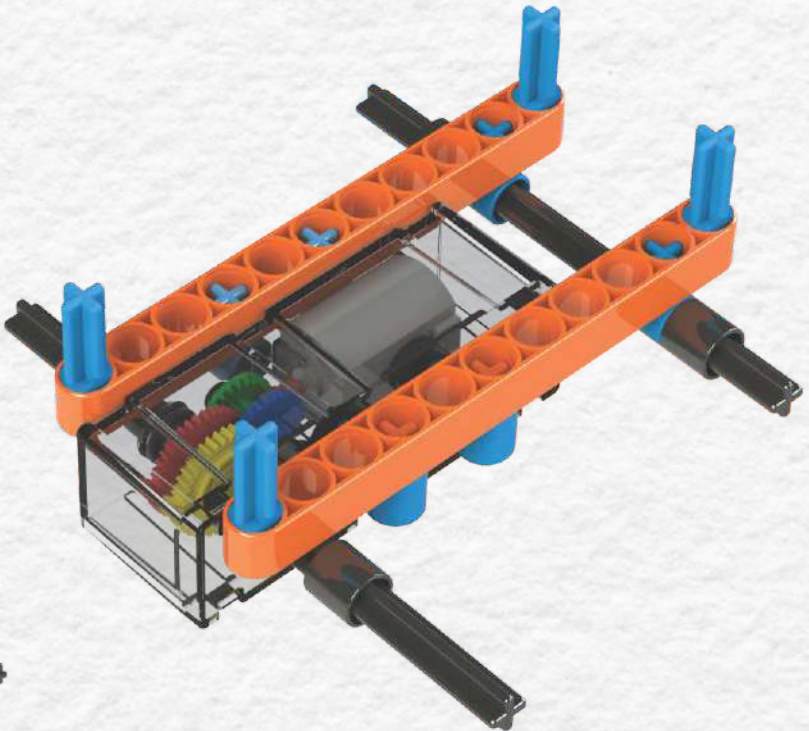

Step - 3



Wheels 4 pcs.

P11 2 pcs.

Step - 4

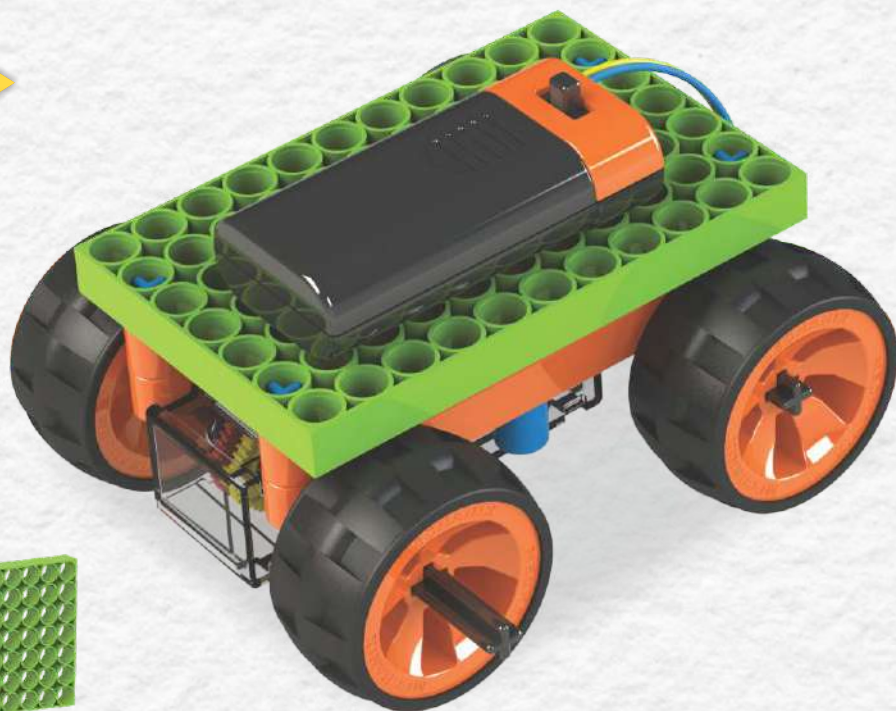

P7X11 1 pc.

Step - 1



P11 2 pcs.



CT2 8 pcs.

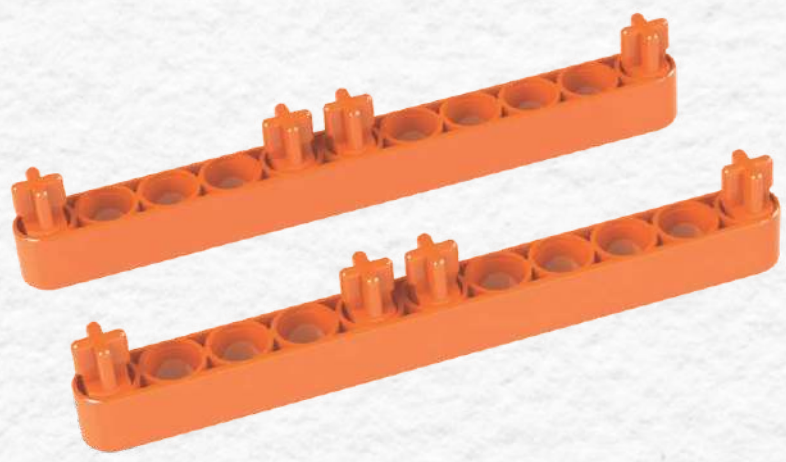

Step - 2

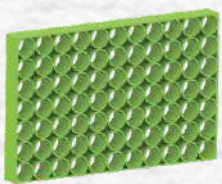
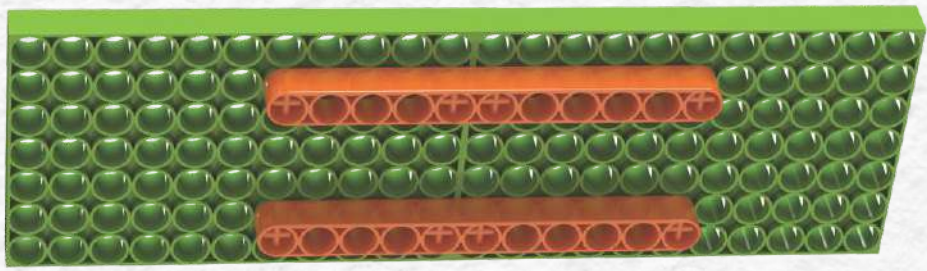

P7X11 2 pcs.

Step - 3



CT2 7 pcs.



CT3 2 pcs.



CH2 3 pcs.

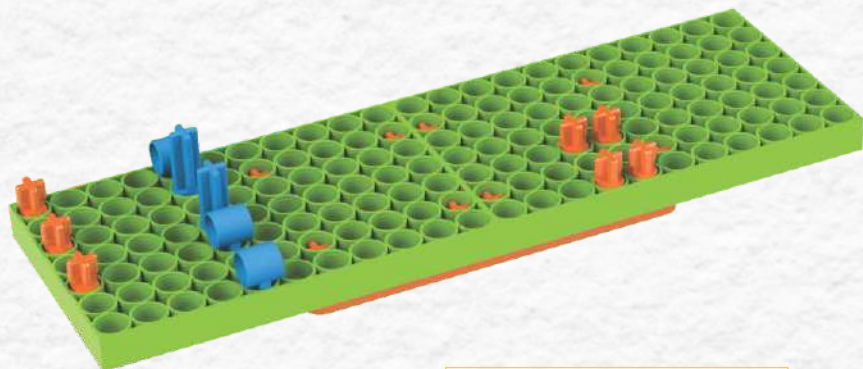

Double check if all pieces are in the right places.

Step - 4



P3 3 pcs.



P5 1 pc.

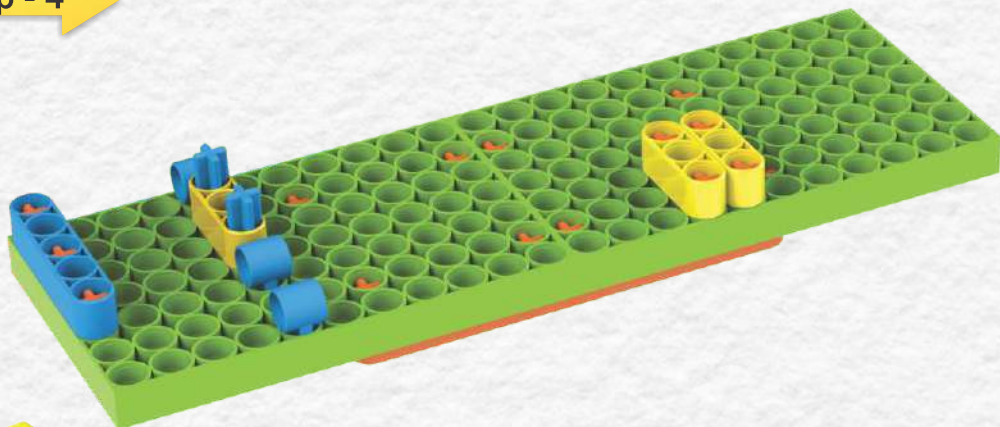

Step - 5



CH2 4 pcs.



Motor 1 pc.

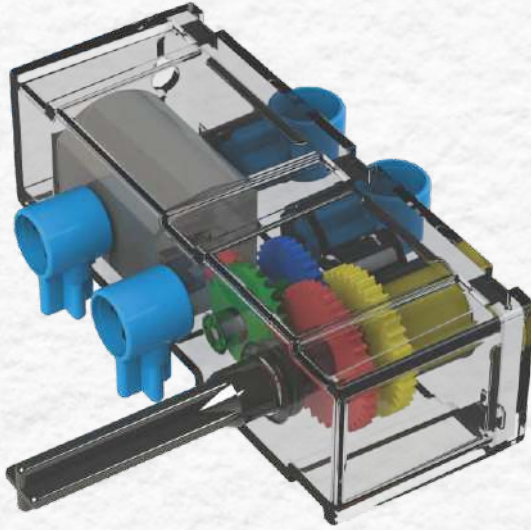

Step - 6

Assembly of step 4 and step 5

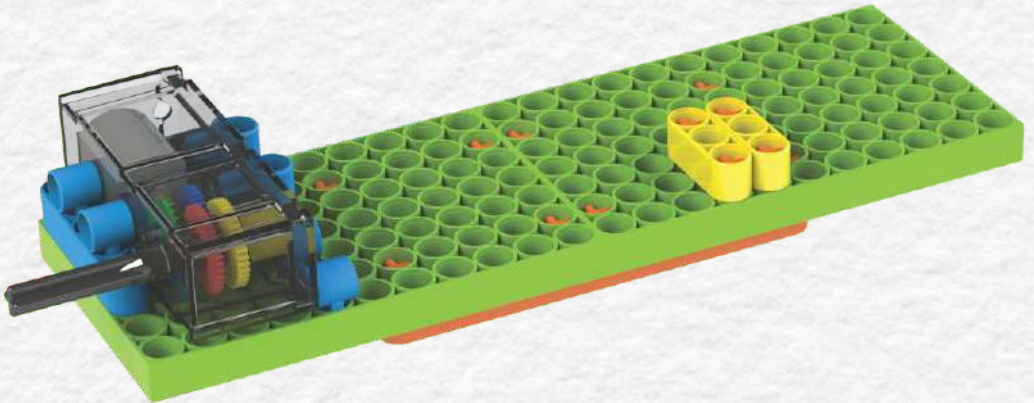

Step - 7



CT2 5 pcs.

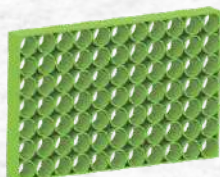

P7X11 2 pcs.



Power Screw 1 pc.



P5 Nut 1 pc.

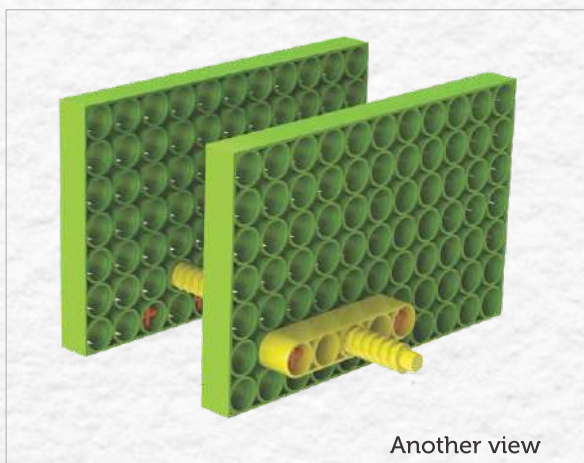
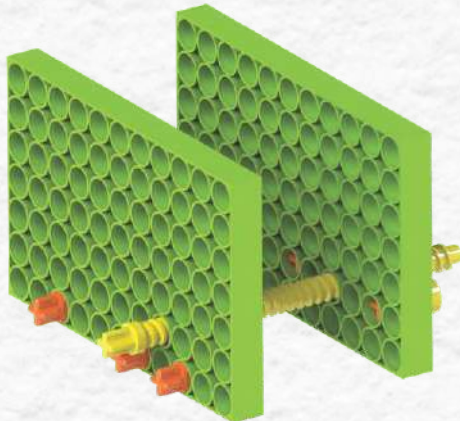

Another view

Step 8

Assembly of step 6 and step 7



CH2 2 pcs.

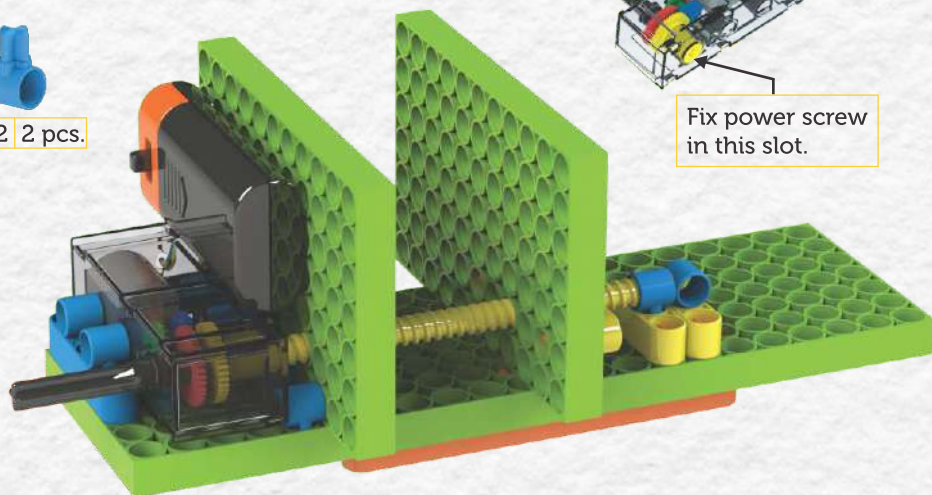

Fix power screw in this slot.

Step - 1

 P3 2 pcs.

 CH2 5 pcs.

 P11 2 pcs.

 CT2 8 pcs.

 CL2 1 pc.

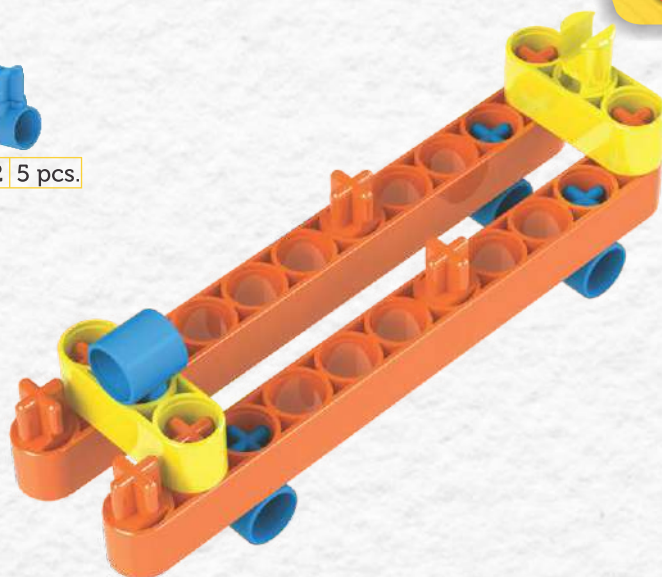

Step - 2

 P3 1 pc.

 P5 2 pcs.

 CT2 2 pcs.

 CT3 1 pc.

 CH2 4 pcs.

 Steering Wheel 1 pc.

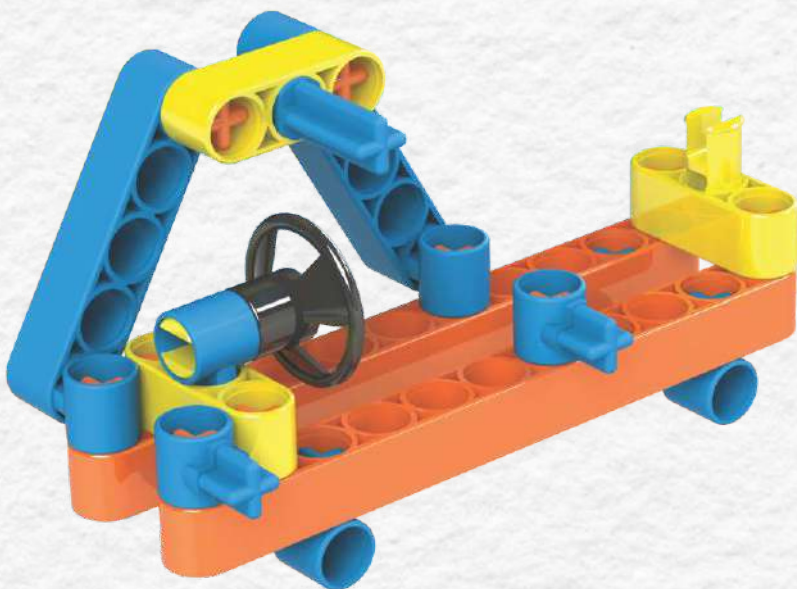

Step - 3



Place 2 TW1's on shaft before each wheel.



TW1 8 pcs.



CT2 2 pcs.



P3 2 pcs.

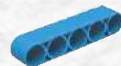

P5 2 pcs.



Wheels 4 pcs.



SH100 2 pcs.

Step - 4



CT2 10 pcs.



CT3 6 pcs.

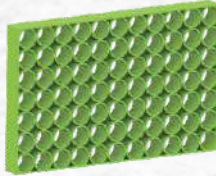

P7X11 2 pcs.

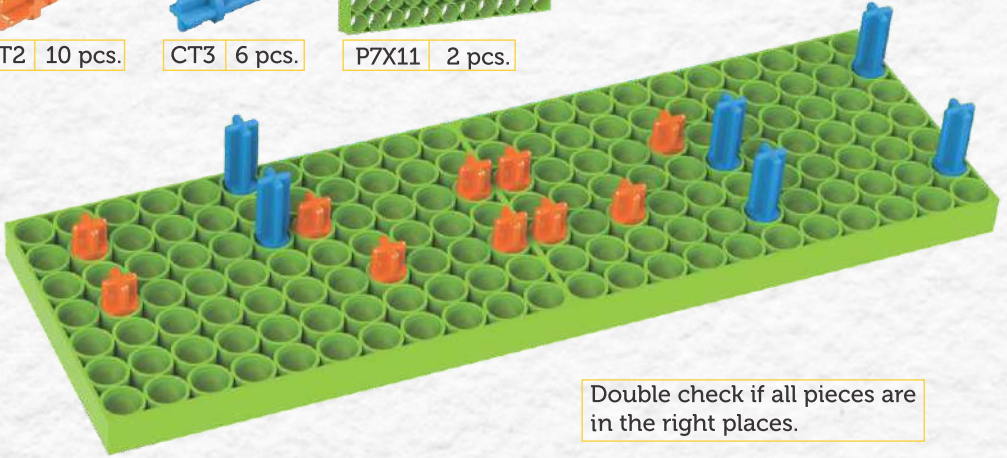

Double check if all pieces are in the right places.

Step - 5

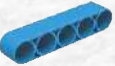

P5 1 pc.



TW1 4 pcs.



CH2 2 pcs.



CL2 2 pcs.



P11 4 pcs.

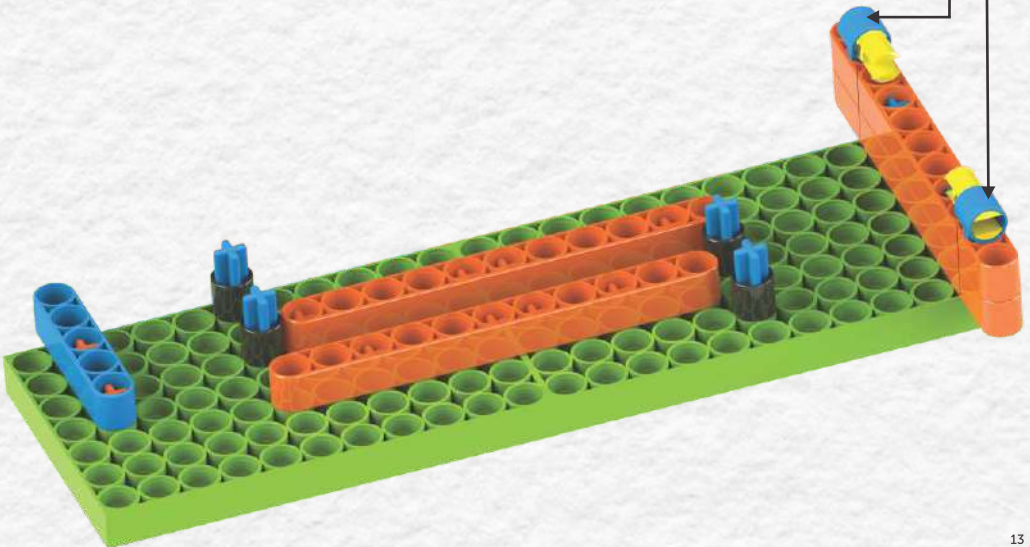

2nd Hole

Step - 6



P5 Nut 1 pc.



CH2 5 pcs.



Motor 1 pc.



Power Screw 1 pc.



CT2 2 pcs.

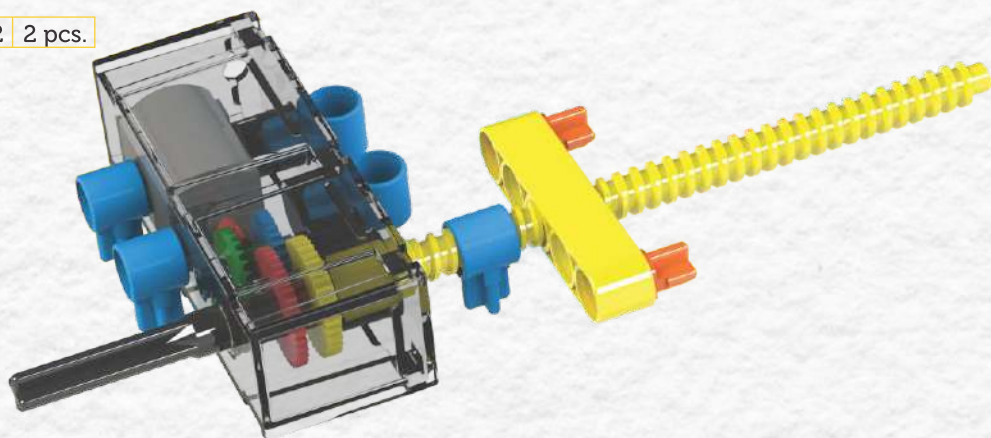

Step - 7



P11 1 pc.



CH2 1 pc.

Ensure P11 is fixed off center as mentioned here.

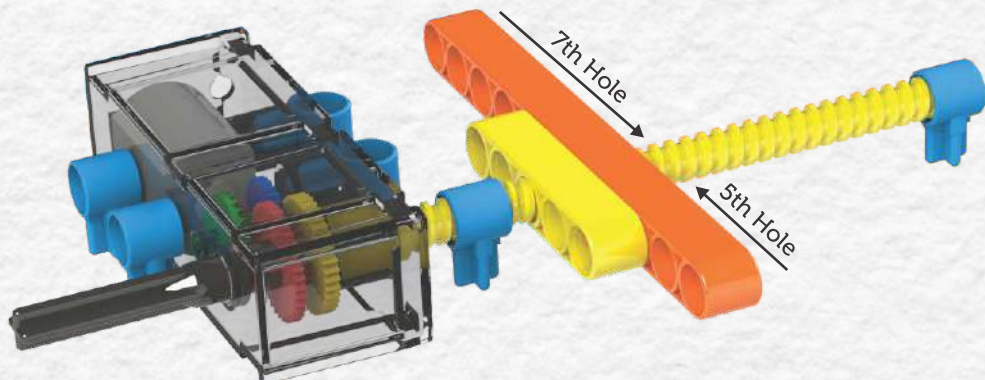

Step - 8



P3 1 pc.



CH2 2 pcs.

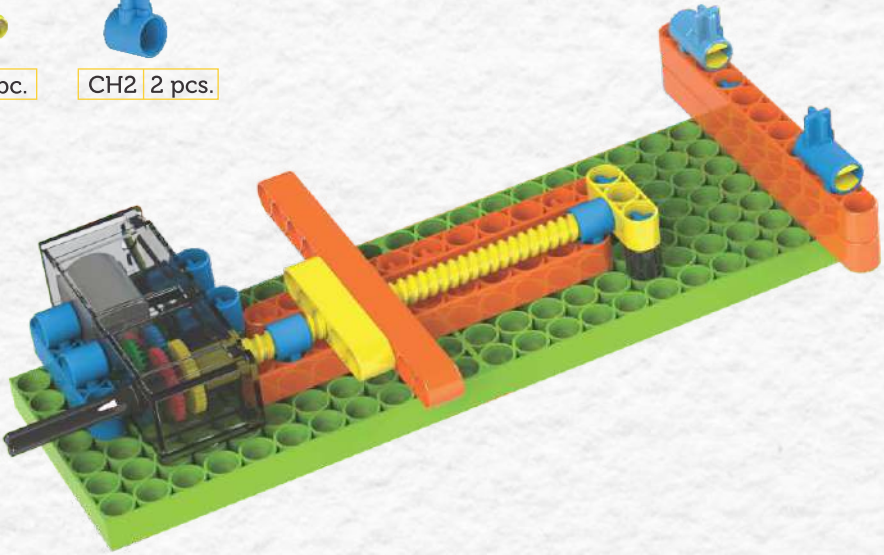

Backside Image

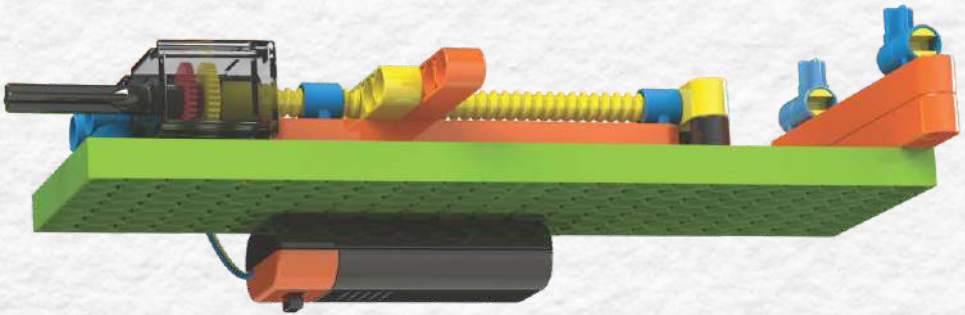

Step - 9



P11 2 pcs.



CL2 4 pcs.



CH2 4 pcs.

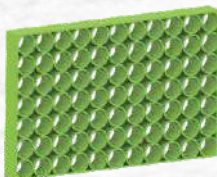

P7X11 1 pc.

Fix CH2 on 3rd Hole

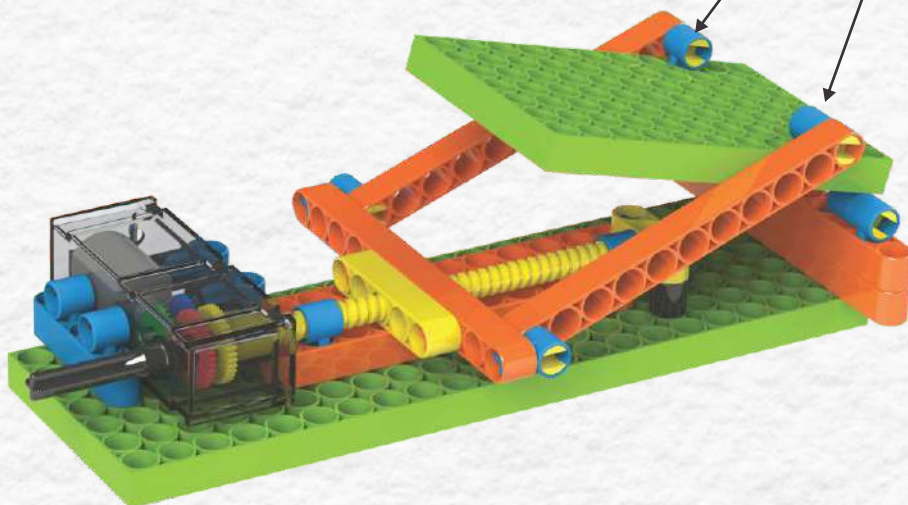

Step - 10



P11 2 pcs.



CT2 8 pcs.

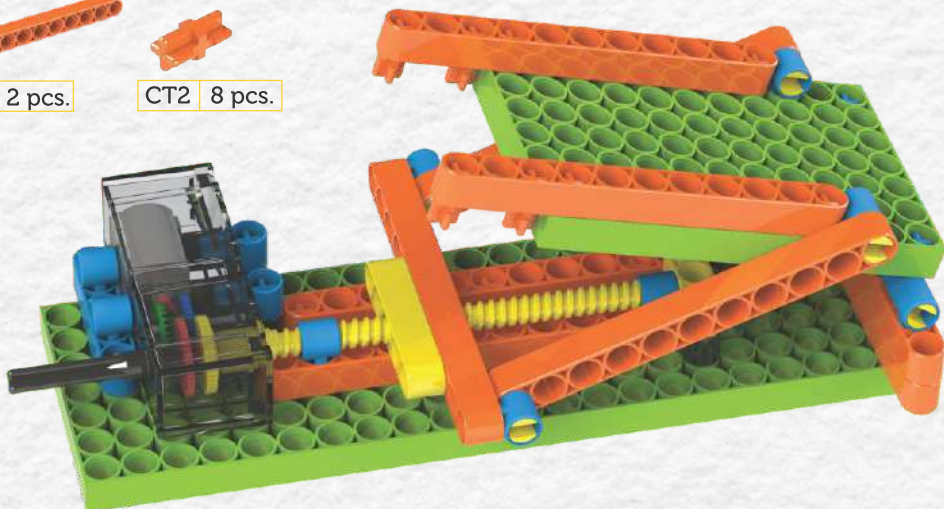

Step - 11



P11 3 pcs.



CT2 6 pcs.

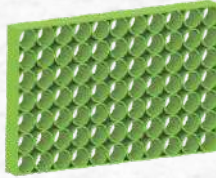

P7X11 1 pc.

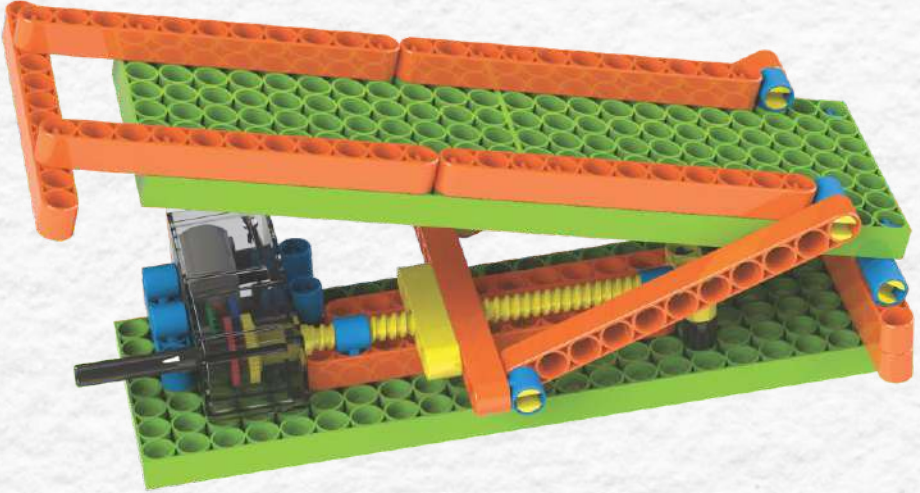

Step - 12

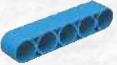

P5 1 pc.

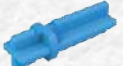

CT3 2 pcs.



CH2 2 pcs.



TW1 4 pcs.



Wheels 2 pcs.



SH100 1 pc.

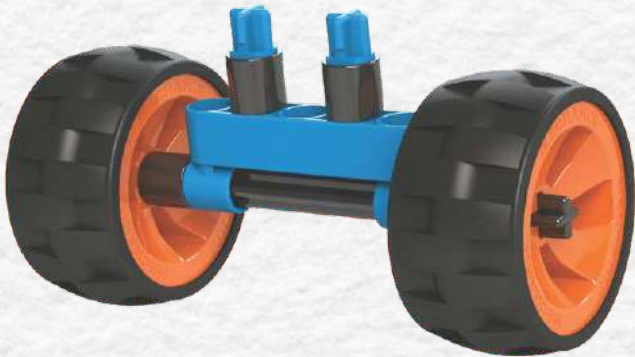

Step - 13

Assembly of step 11 and step 12

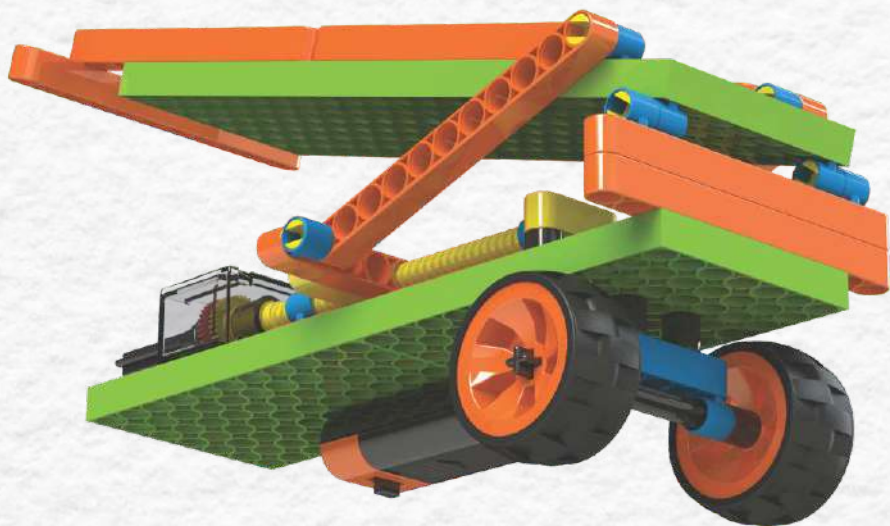

Step - 14

Assembly of step 3 and step 13



Step - 1

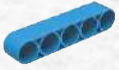

P5 4 pcs.



CH2 4 pcs.



CT3 8 pcs.



CT2 4 pcs.



P11 2 pcs.

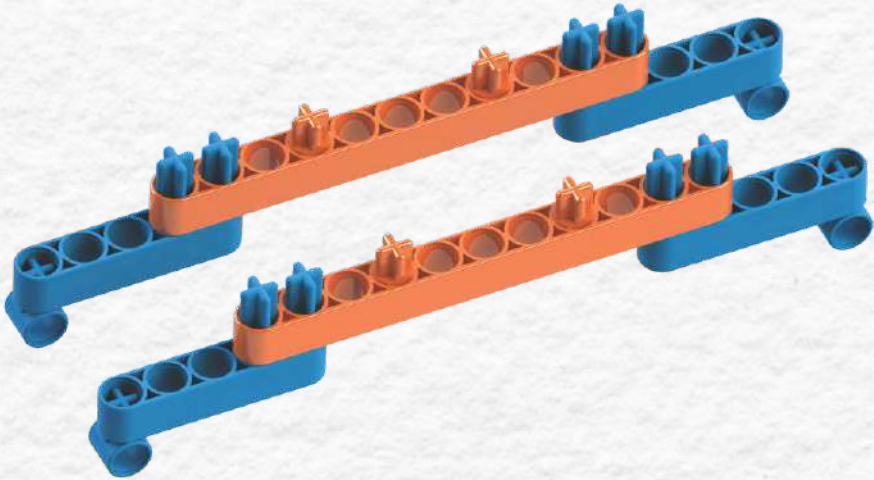

Step - 2

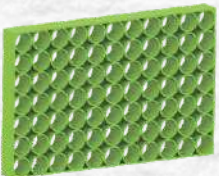
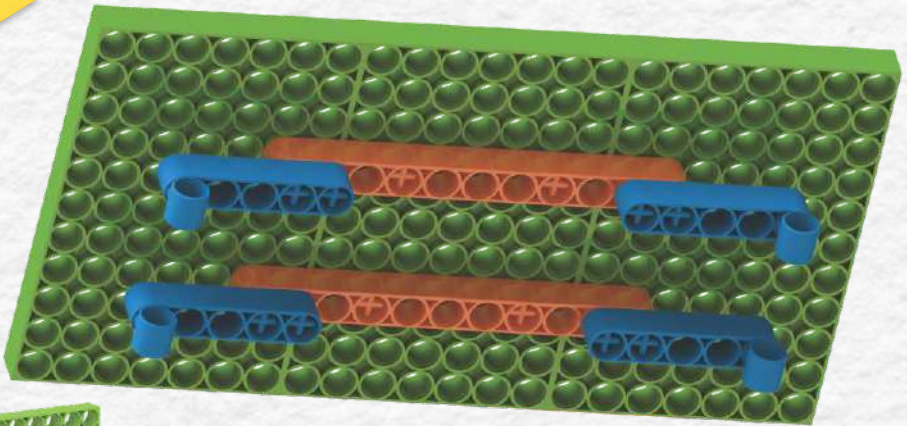

P7X11 3 pcs.

Step - 3



CT2 8 pcs.

CT3 2 pcs.

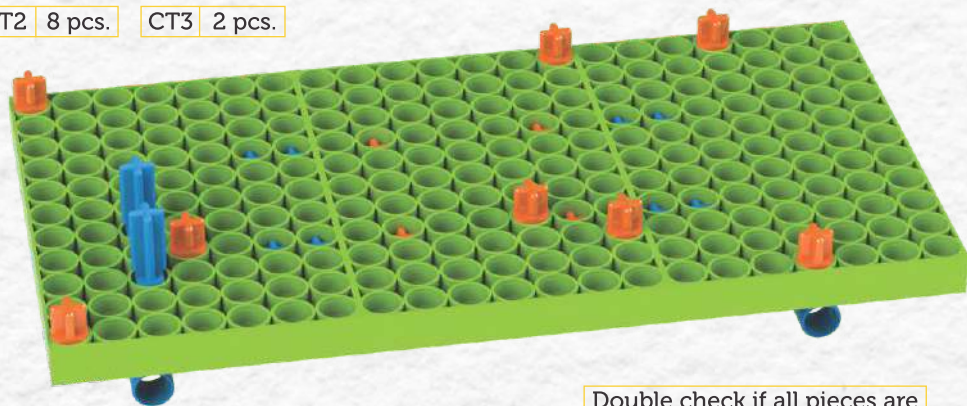

Double check if all pieces are in the right places.

Step - 4



P3 1 pc.

P11 4 pcs.

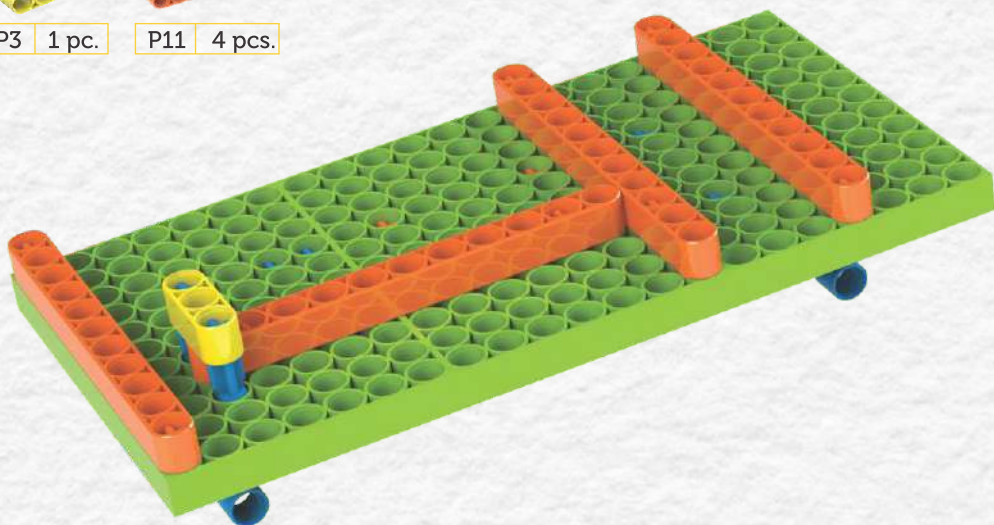

Step - 5



P5 Nut 1 pc.



CT2 2 pcs.



Motor 1 pc.



CH2 6 pcs.



Power Screw 1 pc.

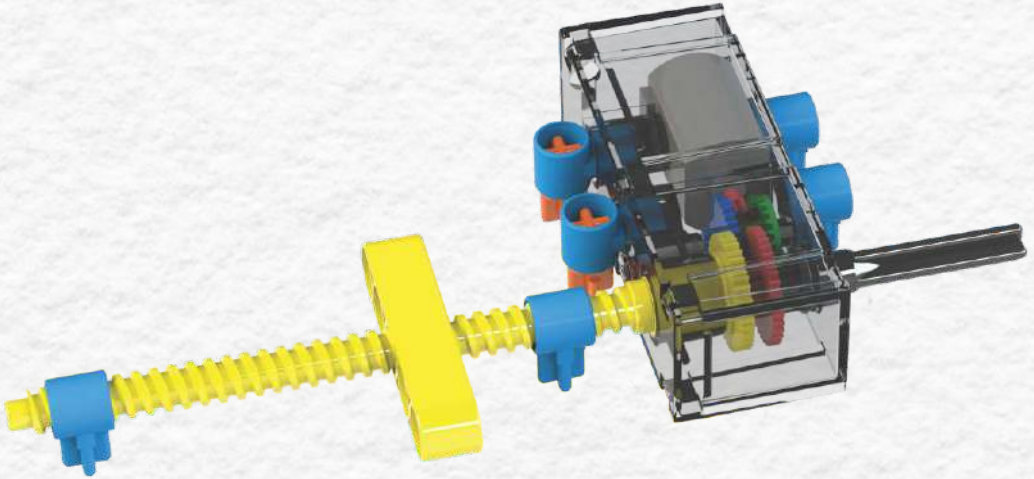

Step - 6

Assembly of step 4 and step 5

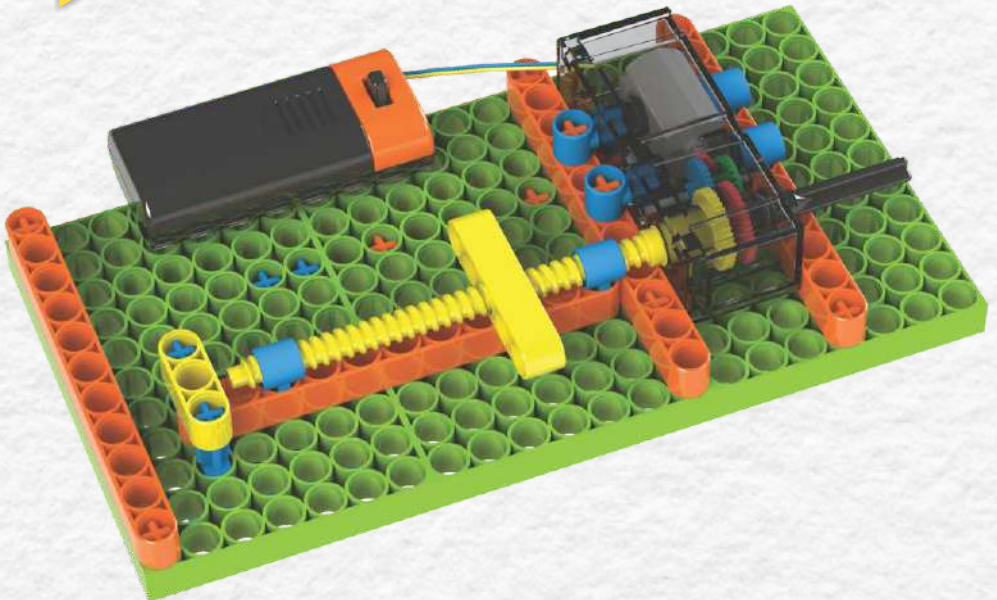

Step - 7



TW1 4 pcs.



Wheels 4 pcs.



SH100 2 pcs.



Place 1 TW1 on shaft before each wheel.

Step - 8



P3 1 pc.



P11 8 pcs.



CT3 1 pc.



CL2 14 pcs.



CH2 4 pcs.

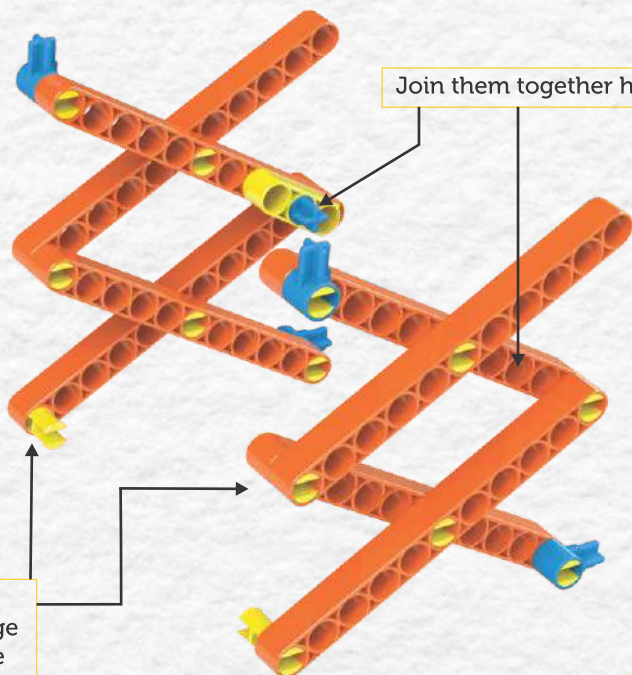

Join them together here

Ensure both assemblies are fixed exactly as shown in image both are different and must be constructed carefully.

Step - 9

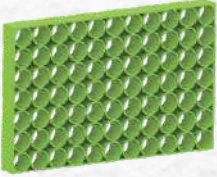

P7X11 1 pc.



CH2 2 pcs.

Fix CH2 on 2nd Hole

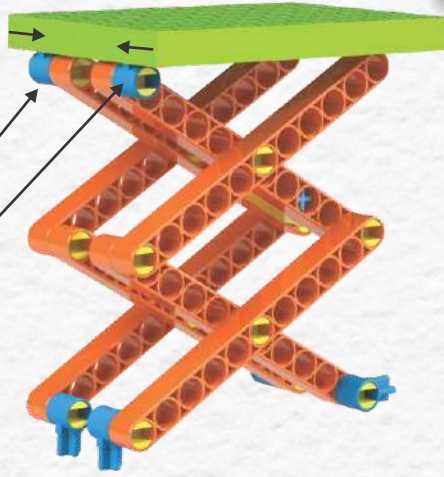

Step - 10

Assembly of step 7 and step 9



Model - 5

Scissor Gate

Step - 1



P11 2 pcs.



CT2 18 pcs.



CT3 2 pcs.

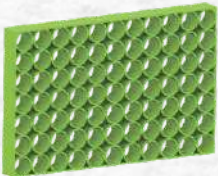

P7X11 4 pcs.

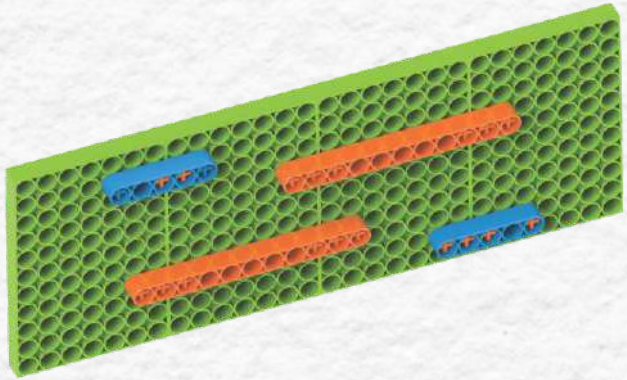
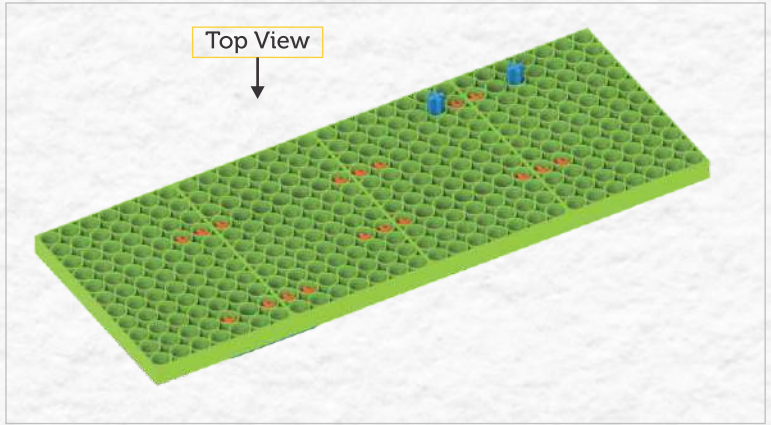

Step - 2



CT2 10 pcs.



CT3 5 pcs.

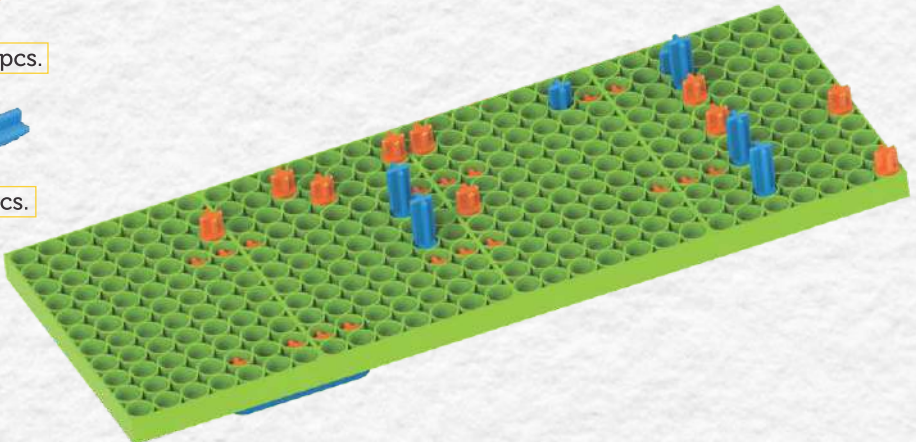

Step - 3



P3 2 pcs.



TW1 4 pcs.



CH2 8 pcs.

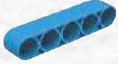

P5 2 pcs.



P11 2 pcs.



P5 Nut 1 pc.



Power Screw 1 pc.

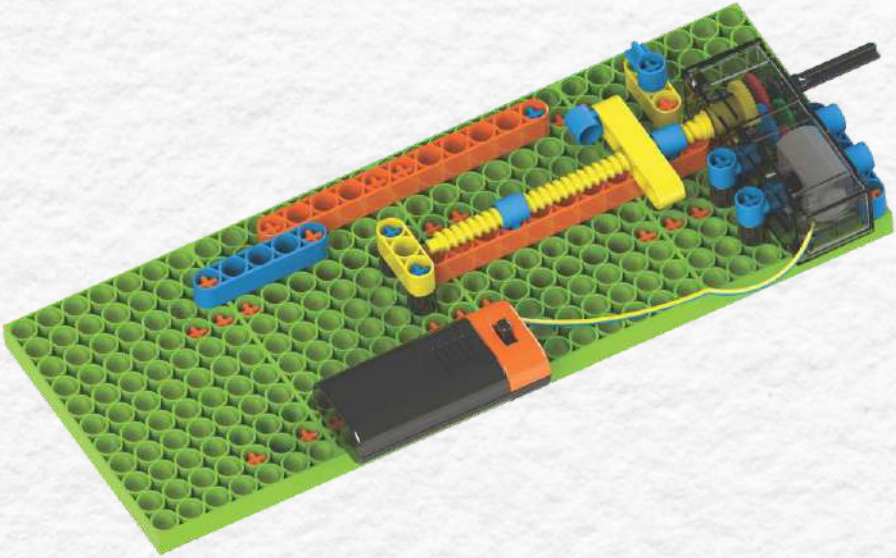

Step - 4



P11 10 pcs.

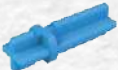

CT3 1 pc.



CL2 12 pcs.

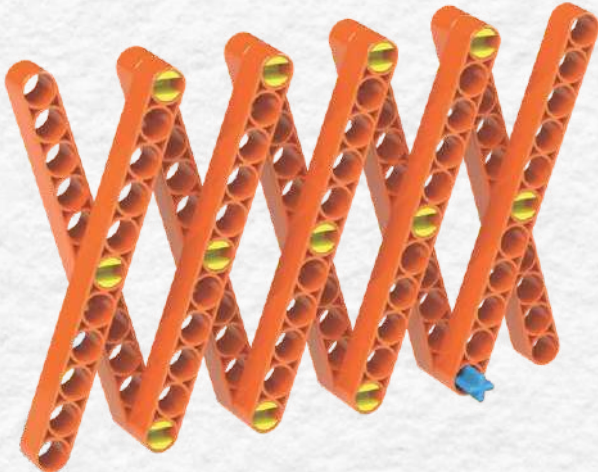

Step - 5

Assembly of step 3 and step 4

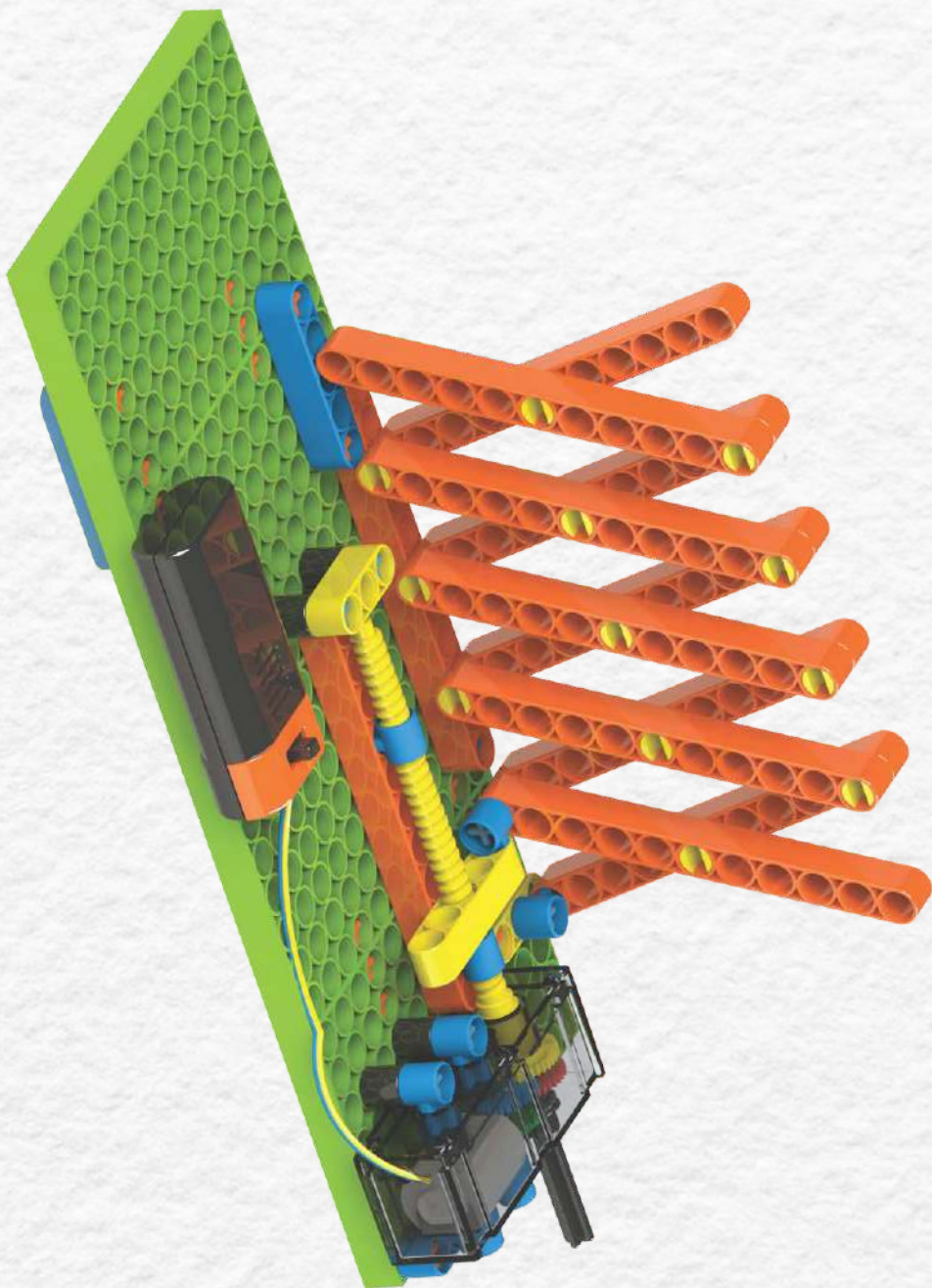

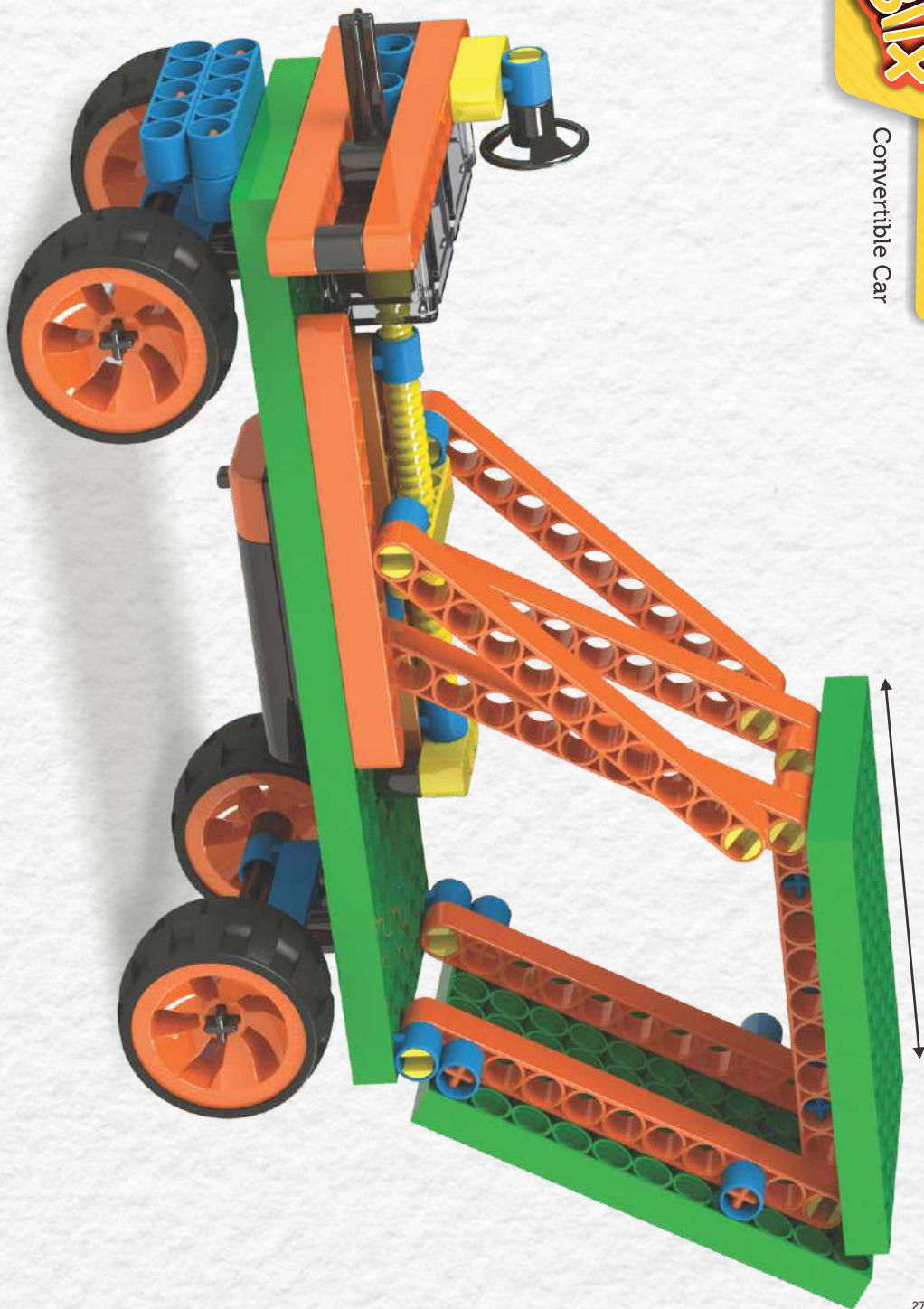



Check out our other
Blix Sets



Blix CARS-1



Blix CARS-2



Watch out for a lot
more construction fun with Blix

Geared Car

Reverse - Neutral - 1st Gear - 2nd Gear

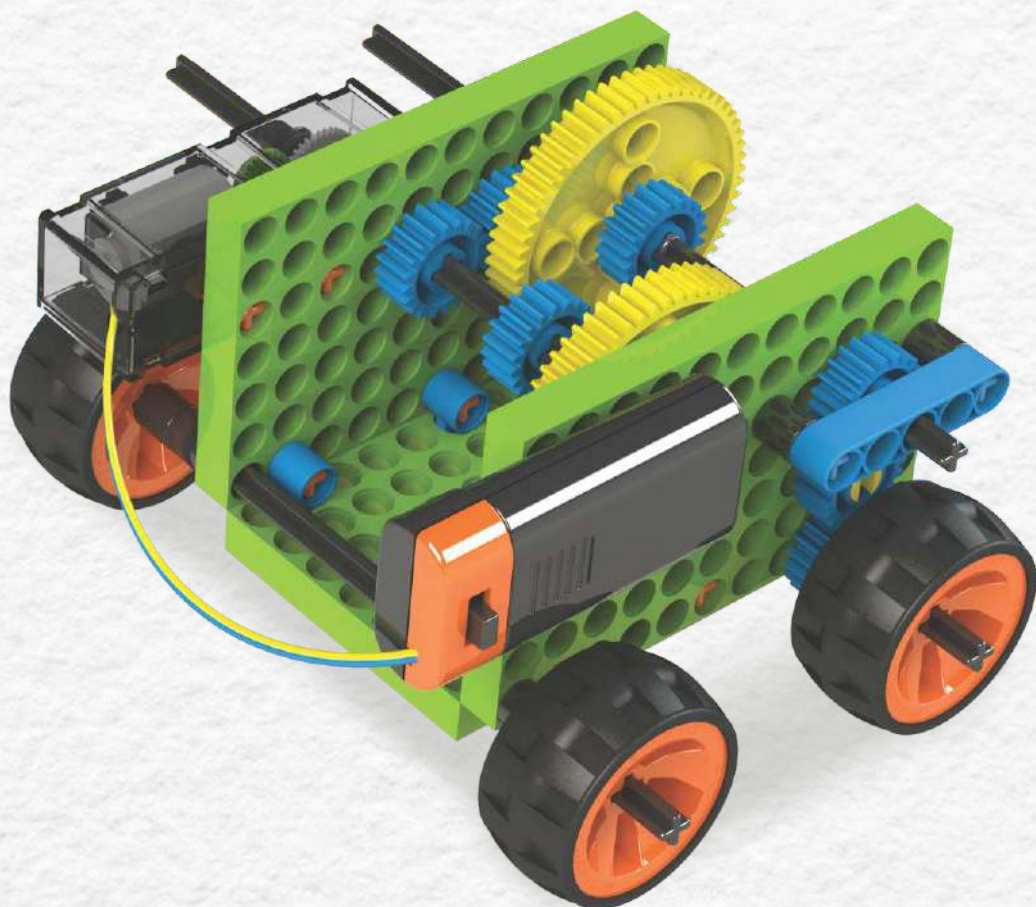

COMING SOON

Also From

ZEPHYR

More Than Just Play

MECHANIX - Robotix - 3



MECHANIX - Battle Station - Transporter



MECHANIX - Eiffel Tower



MECHANIX

Blix

POWER SCREW



P3 8 pcs.

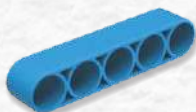

P5 6 pcs.

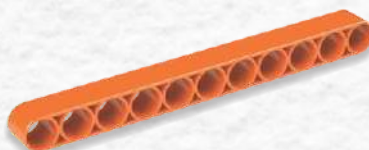

P11 14 pcs.

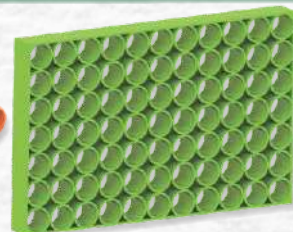

P7X11 4 pcs.



CT2 40 pcs.



CT3 30 pcs.



CL2 30 pcs.



CH2 30 pcs.



TW1 30 pcs.



Wheels 6 pcs.



Battery Box 1 pc.

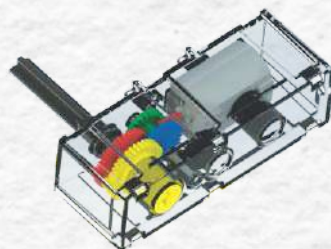

Motor 1pc.



Power Screw
1 pc.

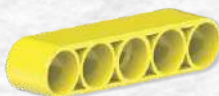

P5 Nut 1 pc.



Steering Wheel 1 pc.



SH60 1 pc.



SH100 3 pcs.



Remover Tool 1 pc.