

8 IN 1

Blix™

RC EXPLORERS

BUILD YOUR OWN REMOTE CONTROLLED TOYS

Do - it yourself manual

- 1 Read all instructions carefully before constructing.
- 2 Place all the pieces used in a step on the side before starting.
- 3 Always remove batteries when not in use.



STEM
ACCREDITED
EDUCATIONAL EXPERIENCE ✓

How to construct

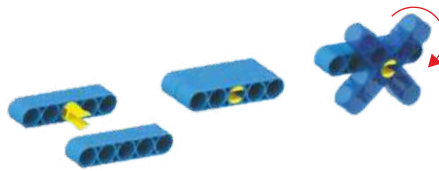

I - CL2 - Use this connector to loosely connect 2 pieces.



II - CT2 - Use this connector to attach 2 pieces.



III - CT3 - Use this connector to attach 3 pieces.



During assembly ensure position of collar is same as in the image in manual.

How to dismantle

- Narrow edge to remove connectors
- Fit the tool into narrow side of connector collar

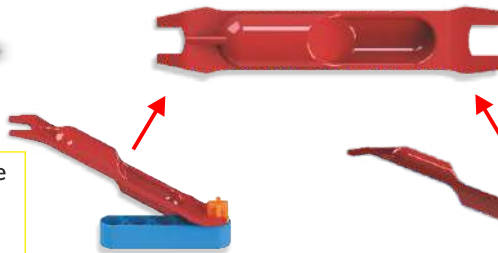

- Broad edge to split two pieces



Safety Guidelines

- Do not mix old and new batteries.
- Do not mix alkaline, standard (Carbon-Zinc) or rechargeable (Nickel-Cadmium) batteries.
- Batteries are to be inserted by matching (+) and (-) polarity markings as shown in the image.
- Non-rechargeable batteries are not to be charged.
- Rechargeable batteries are to be removed before being charged.
- Exhausted batteries are to be removed from toy.
- The supply terminals are not to be short-circuited.
- The kit is not intended for children under 3 years old.
- Remove batteries before cleaning any part of the toy.
- Prevent wire from coming in contact with the wheels and tracks, by using wire clip.

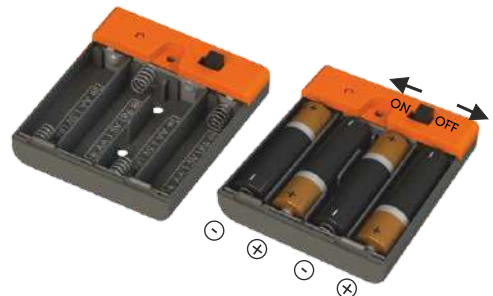

Add 4 x 1.5V "AA" size batteries

Clockwise
Anticlockwise



○ Inserting batteries in the 2.4GHz Transmitter

Steps to pair 2.4GHz Transmitter and Receiver wirelessly.

1. Make sure batteries are inserted in the 6V battery box.
2. Connect 2.4GHz receiver to the 6V battery box
3. Turn on the 6V battery box.
4. LED on the receiver lights up.
5. Make sure batteries are inserted in the 2.4GHz transmitter.
6. Turn ON the transmitter by moving the slide switch to the ON position.
7. The LED on the transmitter starts blinking. It indicates that it is searching the receiver.
8. Once the LED on the transmitter stops blinking, it means that the transmitter and receiver are paired.

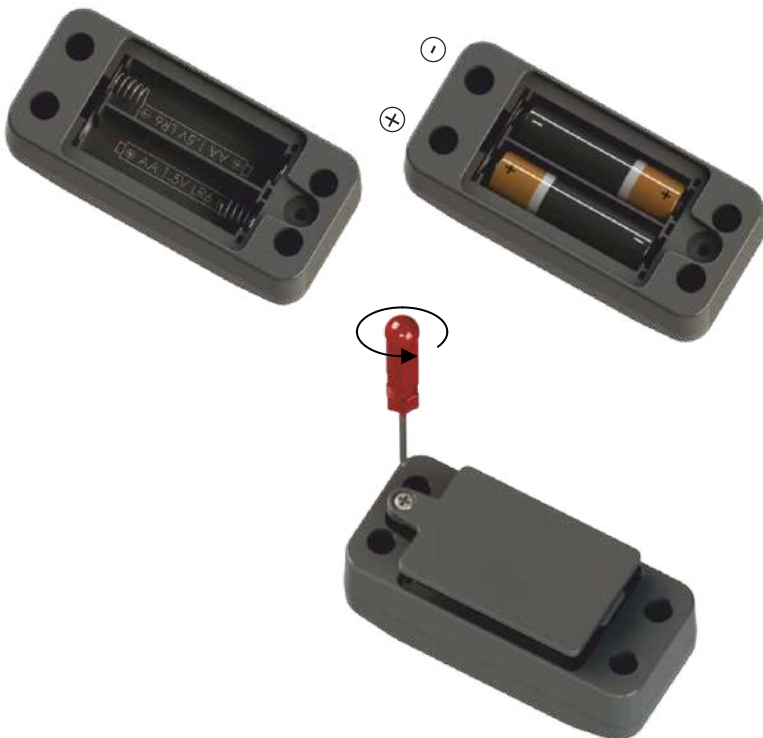

Step - 1



CH2 2 pcs.



CT3 2 pcs.



Motor 1 pc.

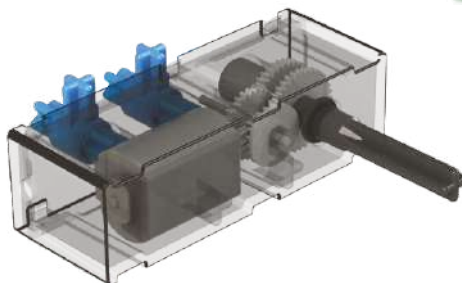

Step - 2



CT3 2 pcs.

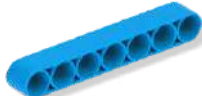

P7 1 pc.



Motor 1 pc.

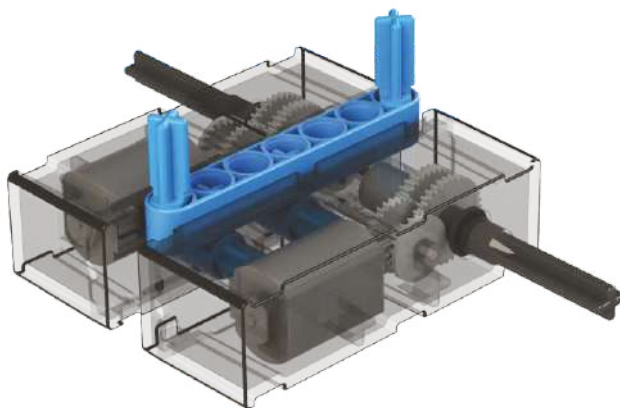

Step - 3

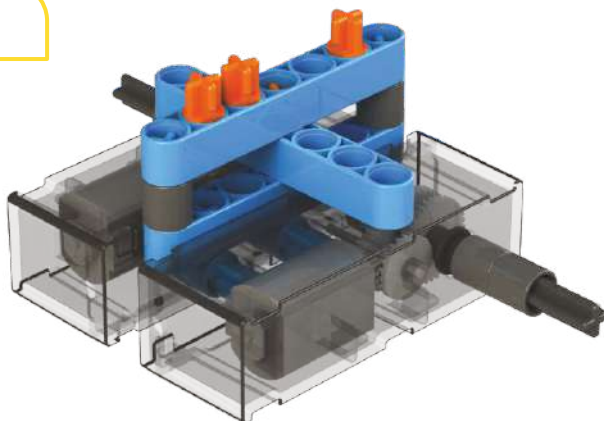

TW1 6 pcs.



CT2 4 pcs.



P7 2 pcs.

Step - 4



CH2 1 pc.



P5 1 pc.



CL2 1 pc.



P11 1 pc.

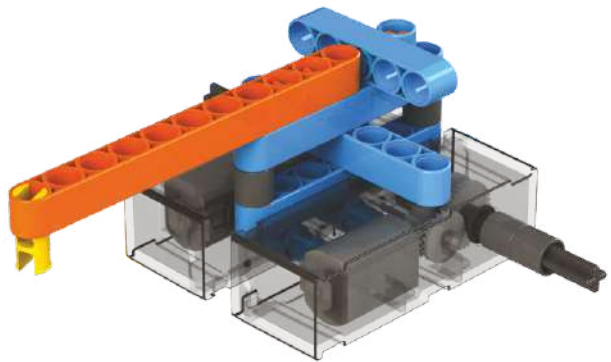

Step - 5



SH60 1 pc.



P3 2 pcs.



TW1 4 pcs.



Wheel 1 pc.



P5 1 pc.



CT3 2 pcs.



CH2 2 pcs.



Step - 6

Assembly of step 4 & 5



Wheels 2 pcs.

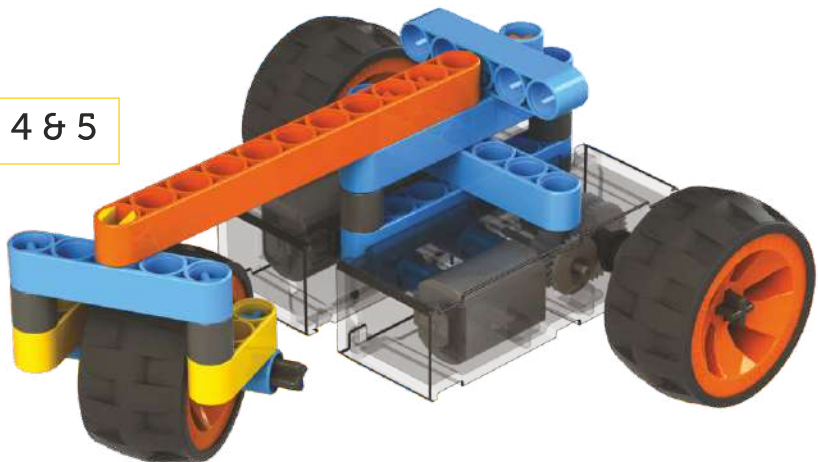

Step - 7

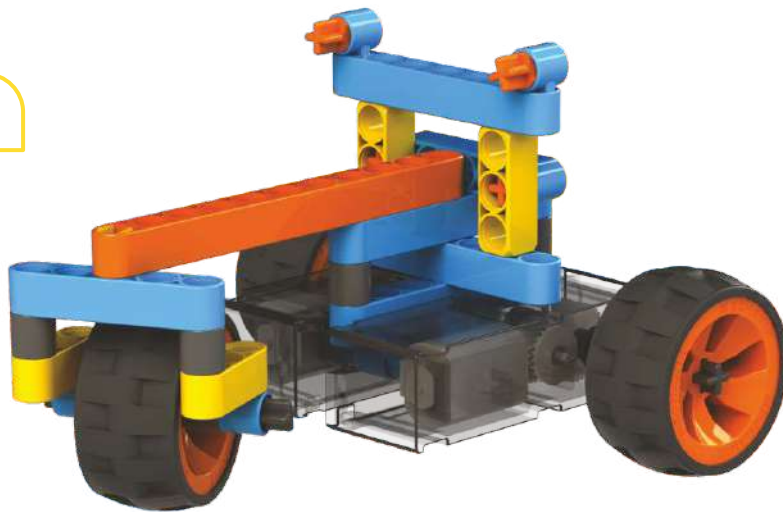

CH2 2 pcs.



CT2 4 pcs.



P3C2 2 pcs.



P7 1 pc.

Step - 8



CH2 2 pcs.



CT2 6 pcs.



P3 2 pcs.

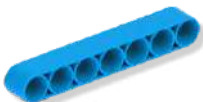

P7 2 pcs.



P7 X 11 1 pc.



Step - 9



CT2 5 pcs.



CH2 2 pcs.



PU5 X 7 1 pc.



Step - 10

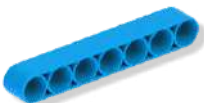

P7 2 pcs.



P7 X 11 1 pc.



Step - 11



2.4GHz Receiver
1 pc.



6V Battery Box
1 pc.



2.4GHz Transmitter
1 pc.

Step - 1



CH2 2 pcs.



CT3 2 pcs.



Motor 1 pc.

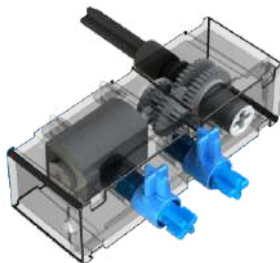

Step - 2



TW1 2 pcs.



CT2 2 pcs.



P5 1 pc.



Motor 1 pc.

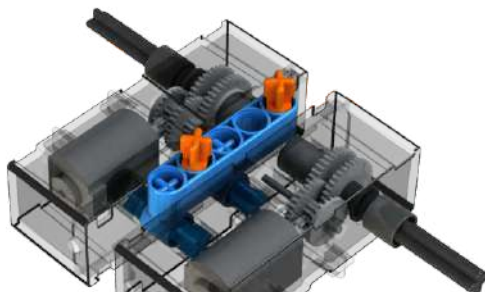

Step - 3



CT2 2 pcs.



P11 1 pc.

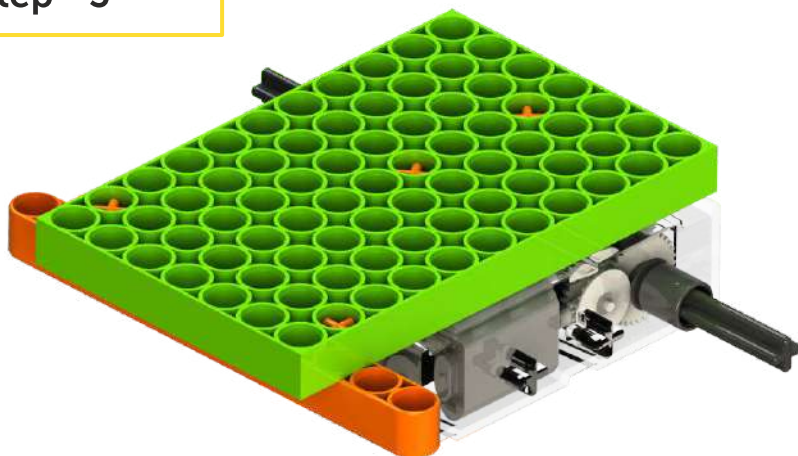

P7 X 11 1 pc.

Step - 4



CH2 4 pcs.



CT2 2 pcs.



CT3 2 pcs.



Wheels 2 pcs.

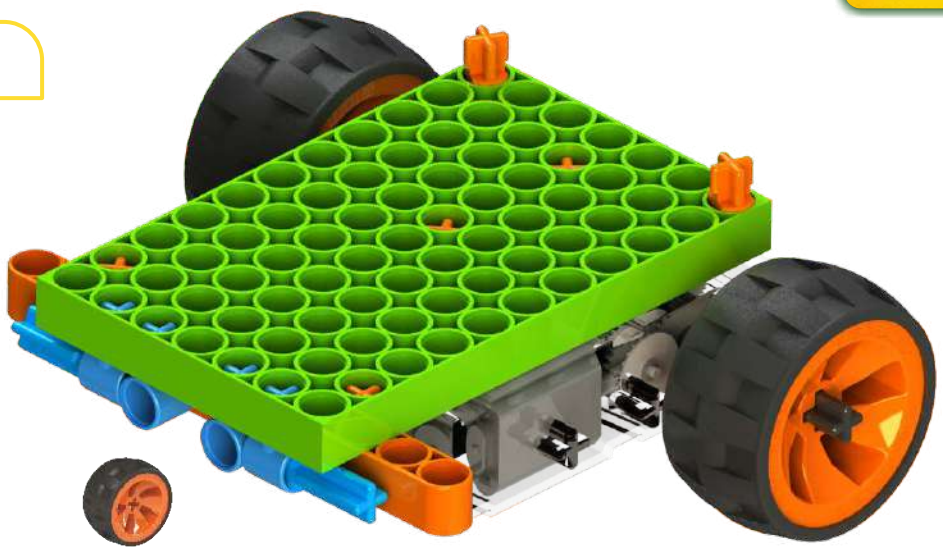

Step - 5



CT2 2 pcs.



P3C2 1 pc.

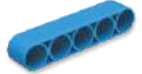

P5 1 pc.

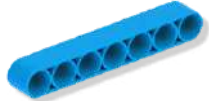

P7 1 pc.



Step - 6

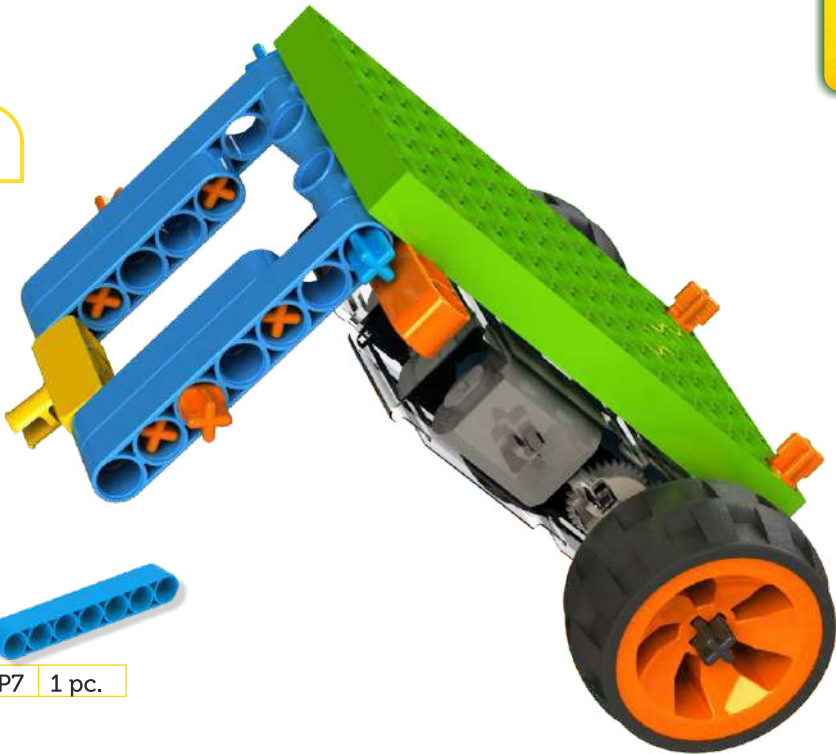

CT2 4 pcs.

CL2 1 pc.

P5 1 pc.

P7 1 pc.

Step - 7

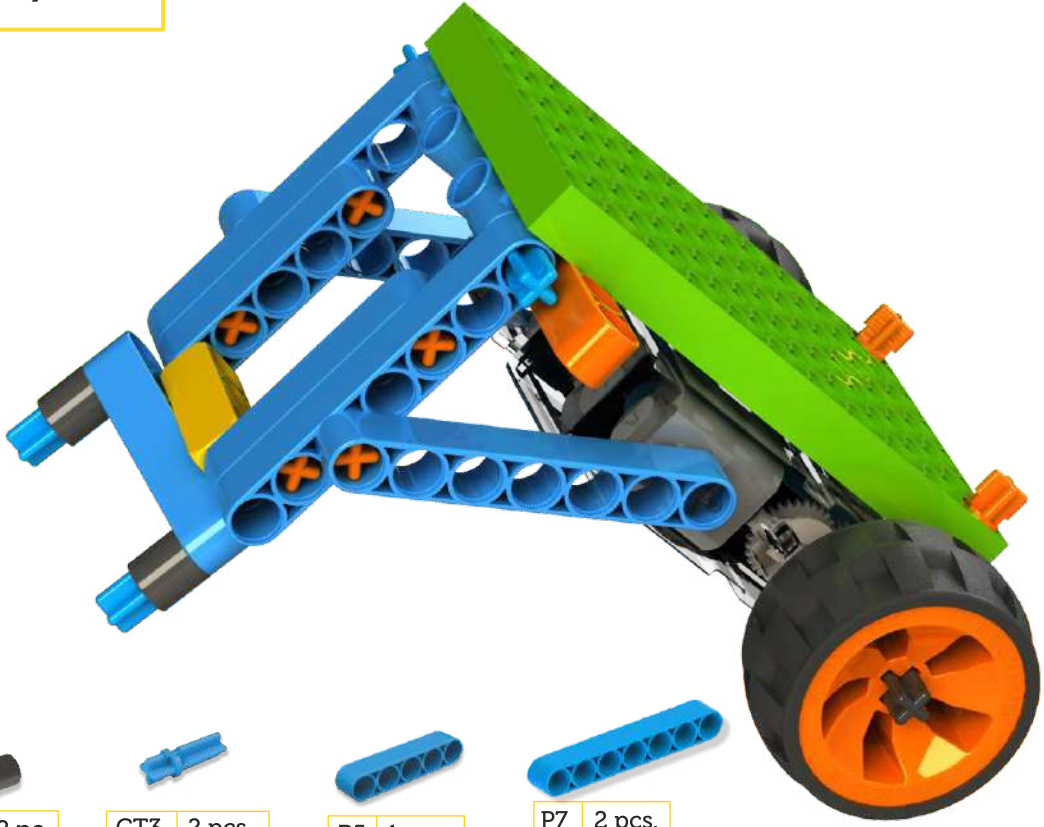

TW1 2 pcs.

CT3 2 pcs.

P5 1 pc.

P7 2 pcs.

Step - 8



TW1 2 pcs.



CH2 2 pcs.



P3 2 pcs.



SH60 1 pc.



Wheel 1 pc.



Step - 9



CH2 2 pcs.



P3 2 pcs.



P3C2 2 pcs.



PU5 X 7 1 pc.



P7 1 pc.



Step - 10



2.4GHz Receiver
1 pc.



6V Battery Box
1 pc.



2.4GHz Transmitter
1 pc.

Step - 1

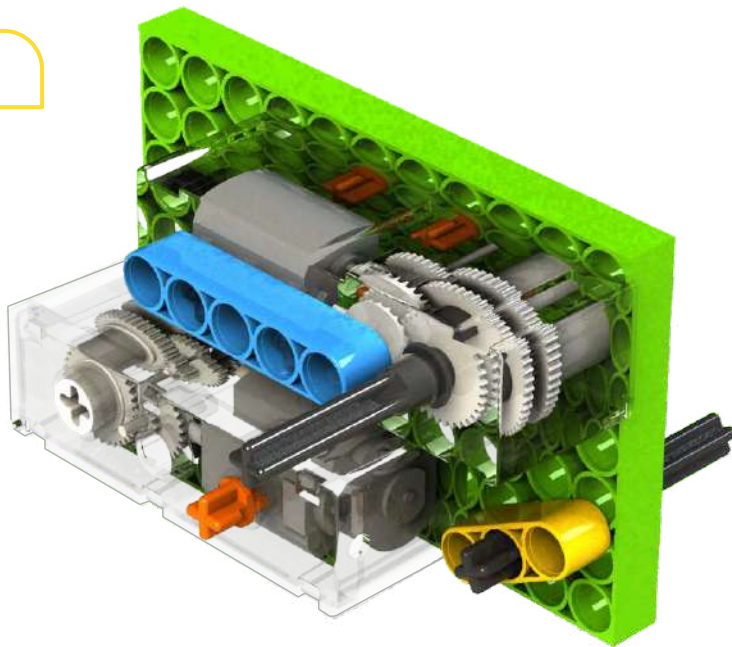

CT2 3 pcs.



P3 Plus 1 pc.

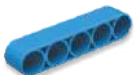

P5 1 pc.



SH60 1 pc.



Motor 2 pcs.



P7 X 11 1 pc.

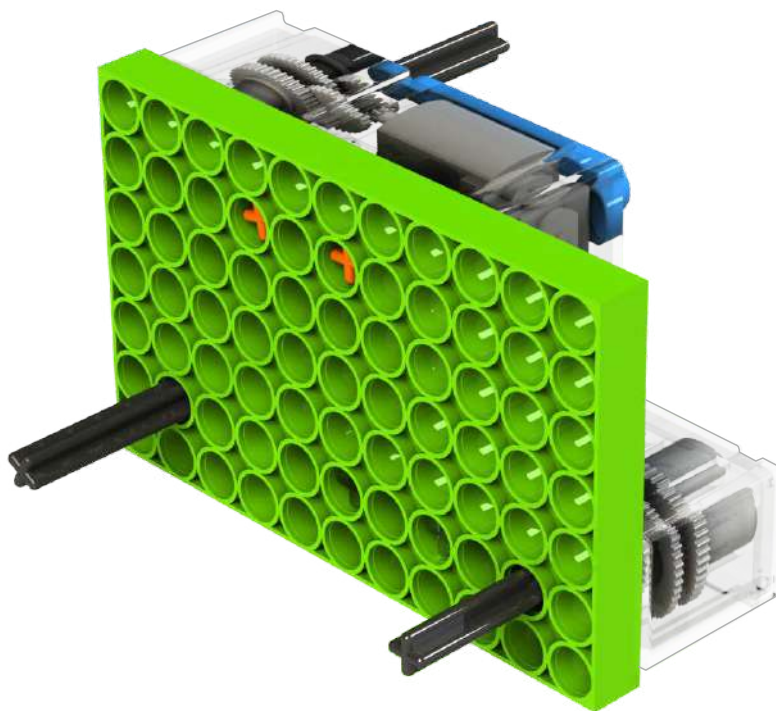

Backside View

Step - 2

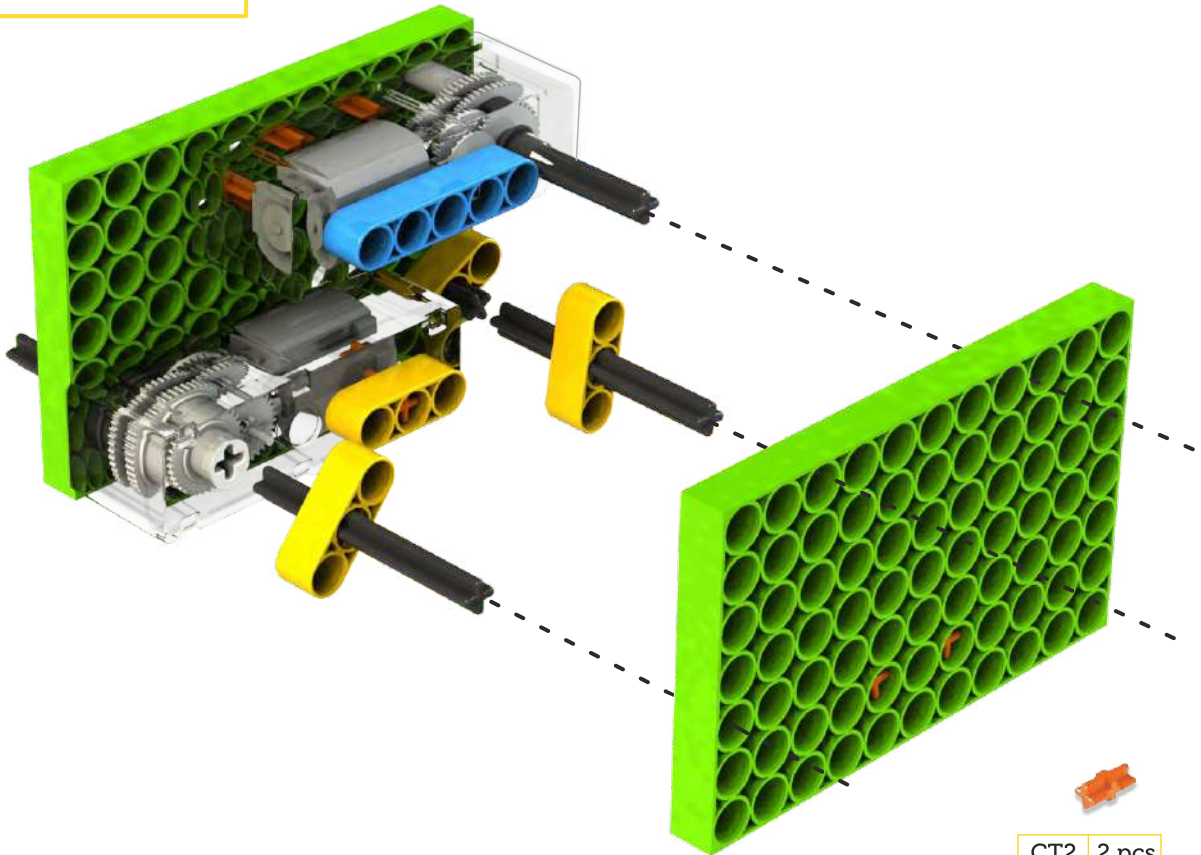

CT2 2 pcs.



P3 1 pc.



P3 Plus 2 pcs.



SH60 2 pcs.



P7 X 11 1 pc.

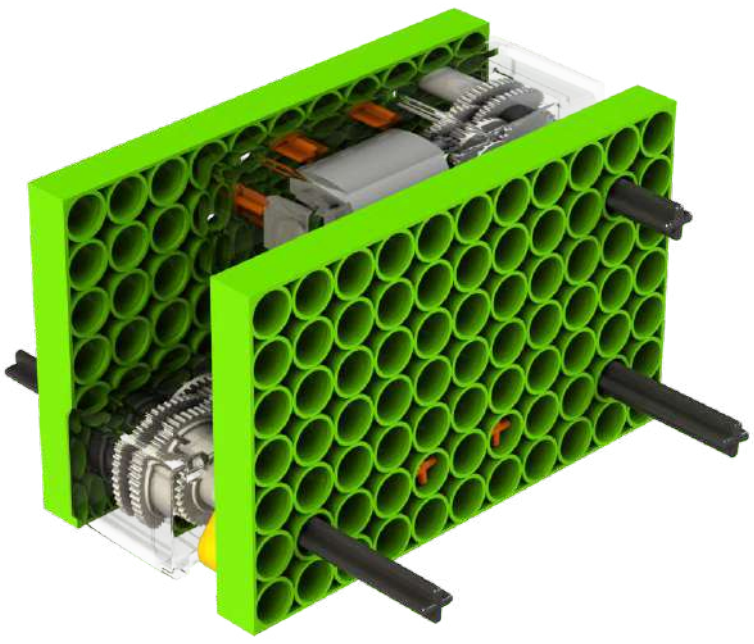

Step - 3



CL2 2 pcs.



SH60 1 pc.

Step - 4



SH60 1 pc.



CL2 2 pcs.



G20 Idler
4 pcs.



G20 5 pcs.



G60 2 pcs.

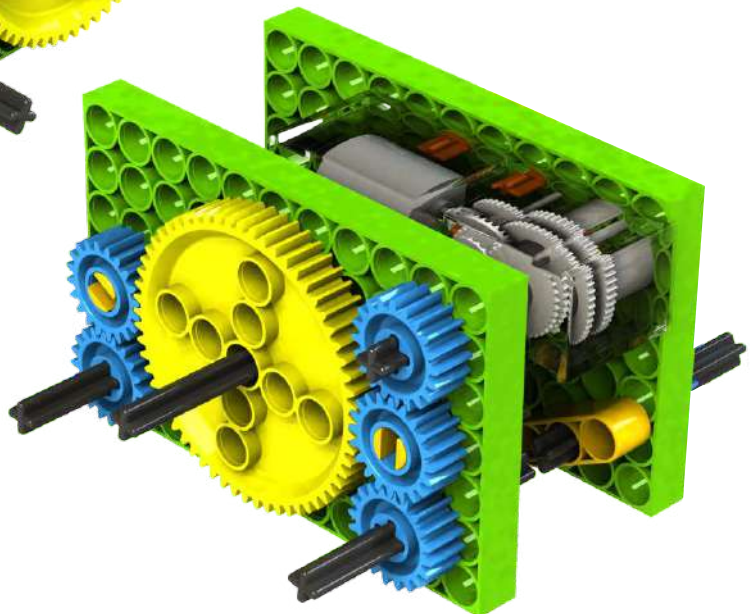

Step - 5

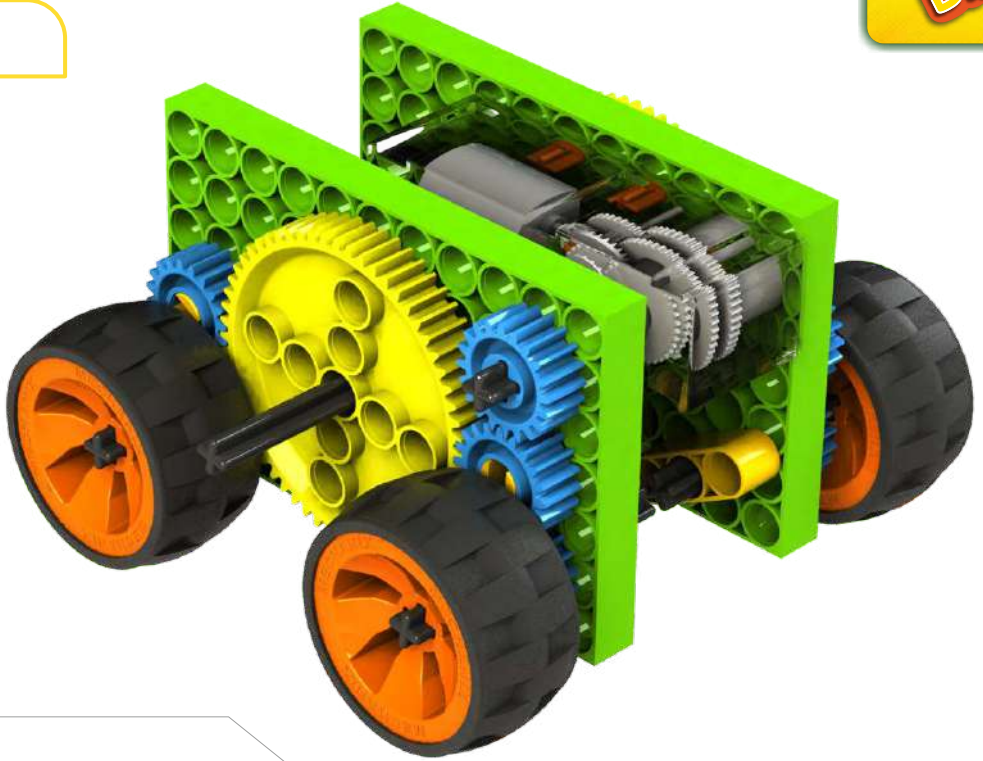

TW1 4 pcs.



Wheels 4 pcs.

Step - 6

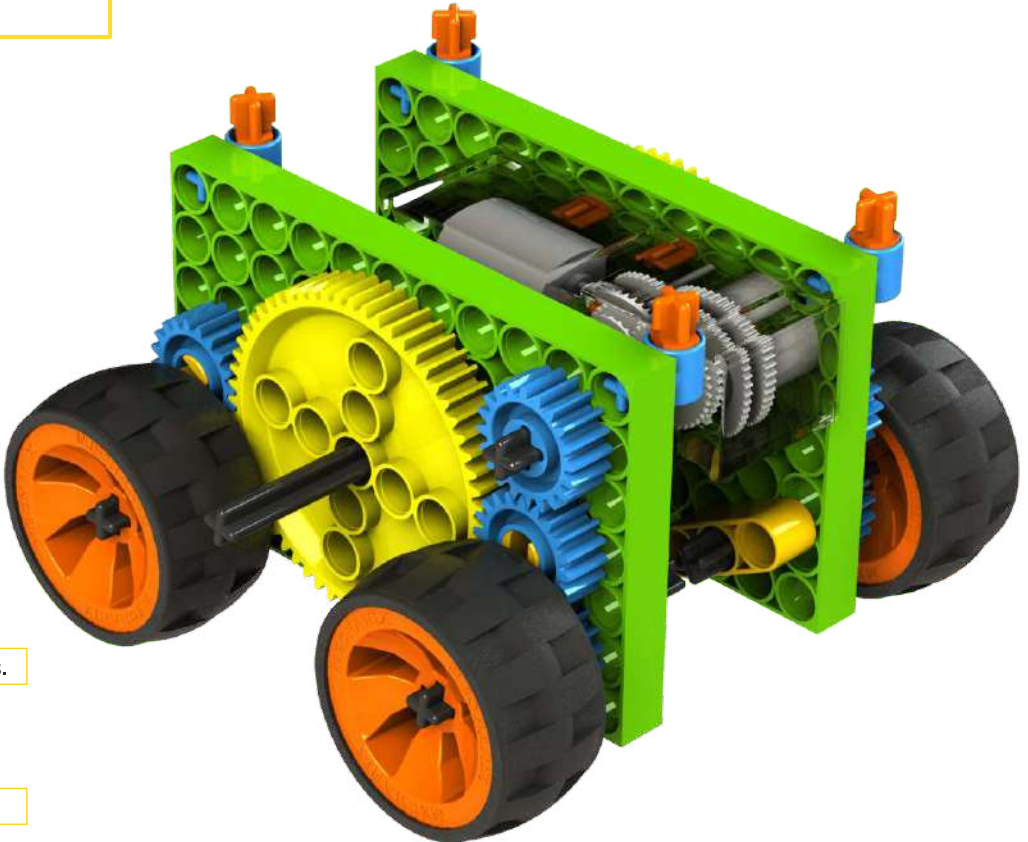

CH2 4 pcs.



CT2 4 pcs.

Step - 5



CH2 2 pcs.



P7 2 pcs.

Step - 6

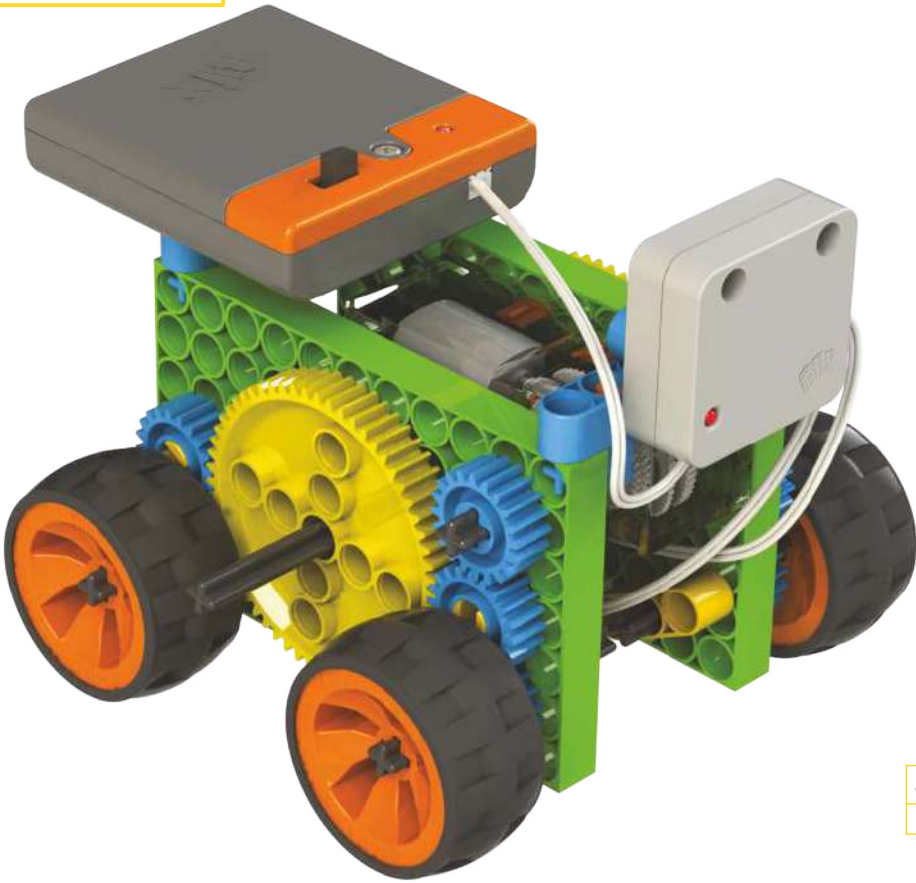

2.4GHz Receiver
1 pc.



6V Battery Box
1 pc.



2.4GHz Transmitter
1 pc.

Step - 1



CT2 1 pcs.



CL2 3 pcs.



SH60 2 pcs.



P7 X 11 1 pc.



Step - 2

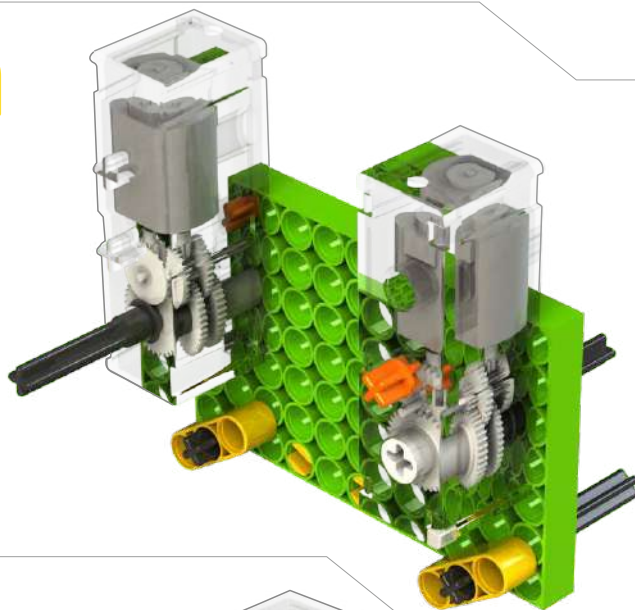

CT2 1 pcs.



P3 Plus 2 pcs.



Motor 2 pcs.

Step - 3

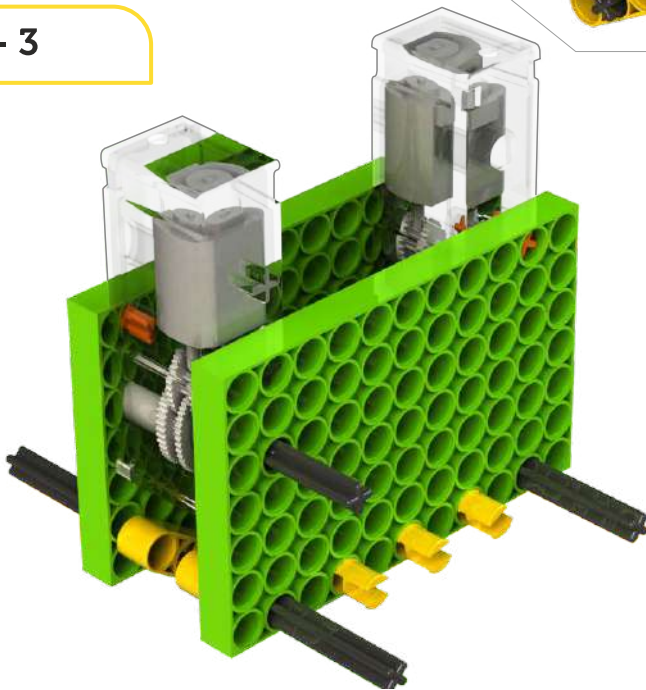

SH60 2 pcs.



CL2 3 pcs.



P7 X 11 1 pc.



P3 Plus 2 pcs.

Step - 4

Backside View

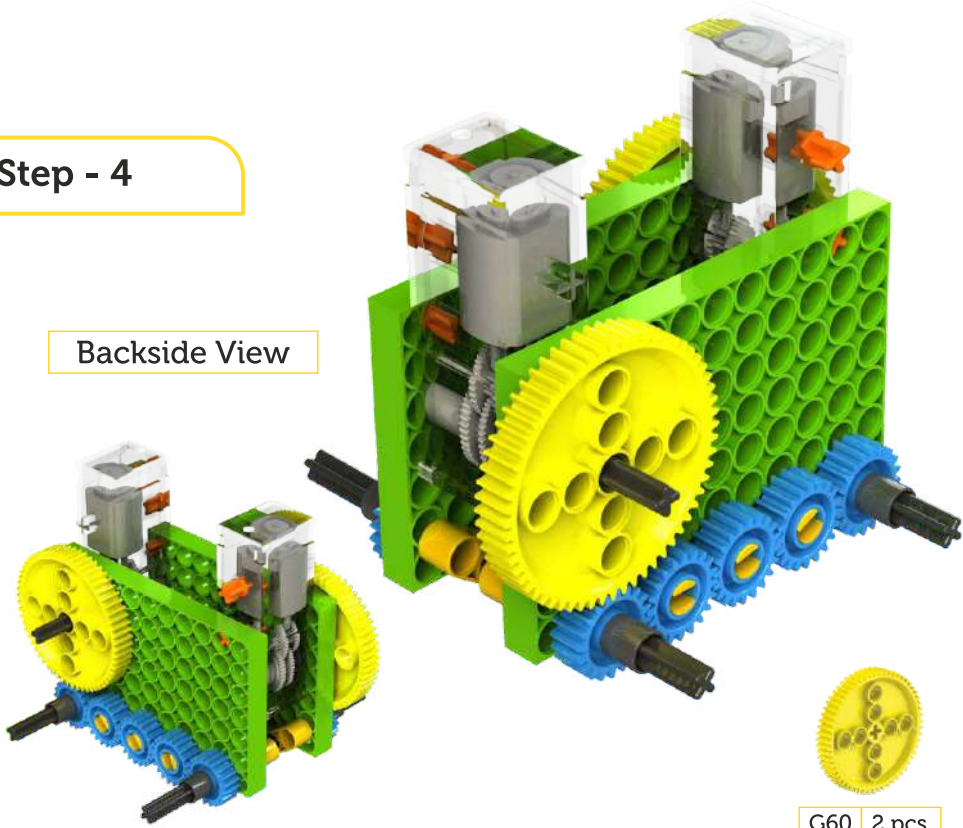

TW1 4 pcs.



CT2 2 pcs.



G20 Idler 6 pcs.



G60 2 pcs.



G20 4 pcs.

Step - 5



CH2 4 pcs.



Wheels 4 pcs.

Step - 6



CT2 4 pcs.

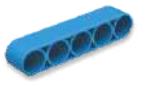

P5 1 pc.



PU5 X 13 1 pc.

Step - 7



P5 2 pcs.

Step - 8



2.4GHz Receiver
1 pc.



6V Battery Box
1 pc.



2.4GHz Transmitter
1 pc.

Step - 1



CT3 2 pcs.



Motor 1 pc.

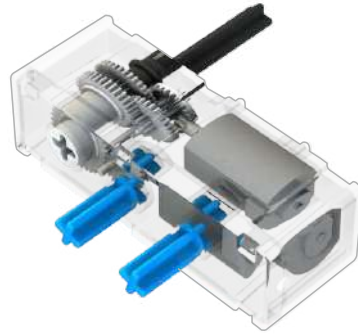

Step - 2

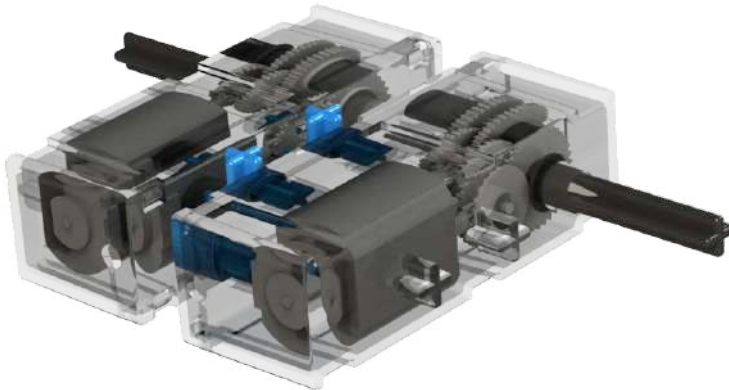

CH2 2 pcs.



Motor 1 pc.

Step - 3



P3 Plus 2 pcs.



CT3 2 pcs.

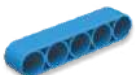

P5 1 pc.

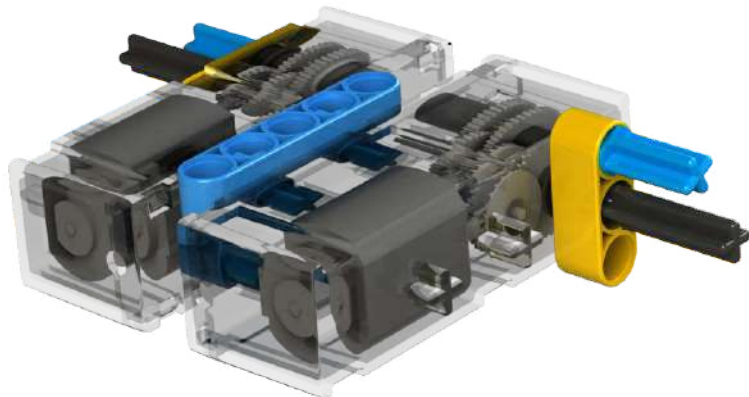

Step - 4

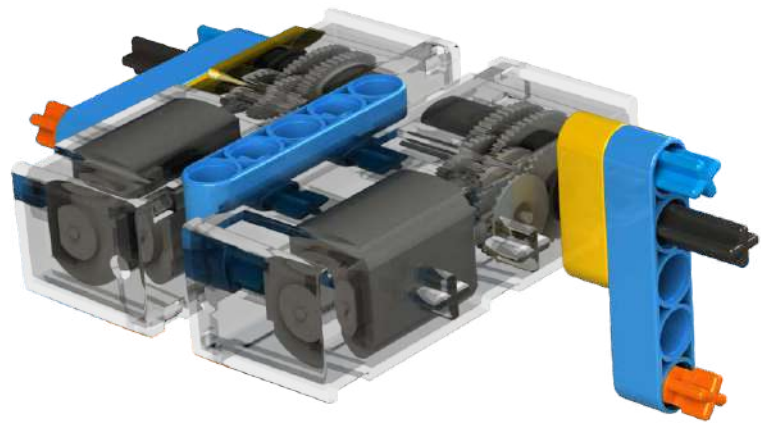

CT2 2 pcs.



P5 2 pcs.

Step - 5

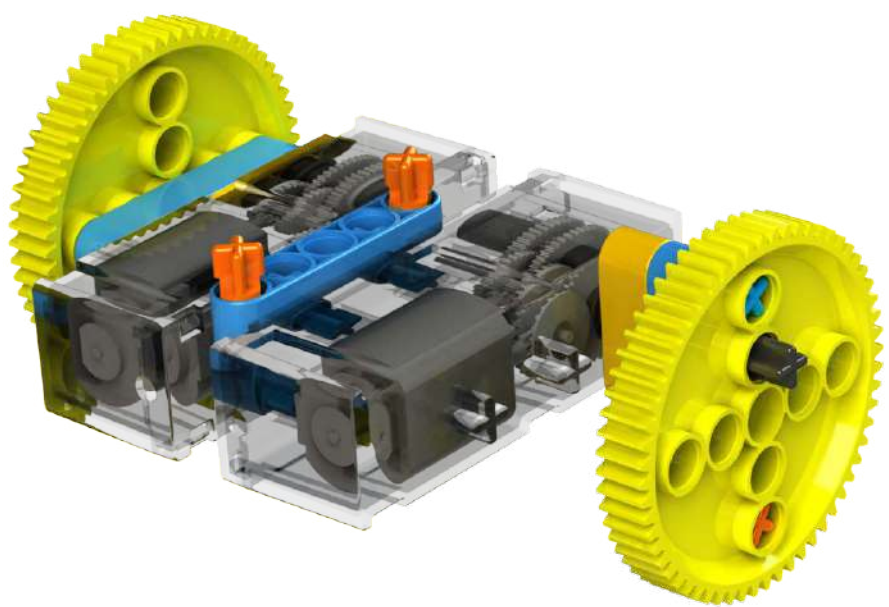

CT2 2 pcs.



G60 2 pcs.

Step - 6

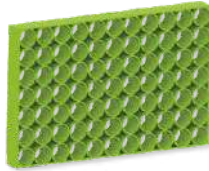
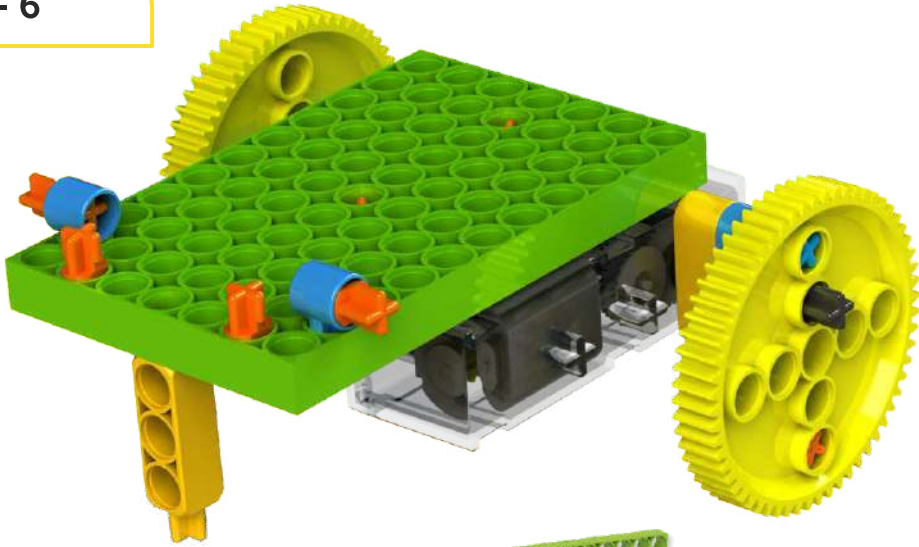

P7 X 11 1 pc.



P3C2 1 pc.



CH2 2 pcs.



CT2 4 pcs.

Step - 7

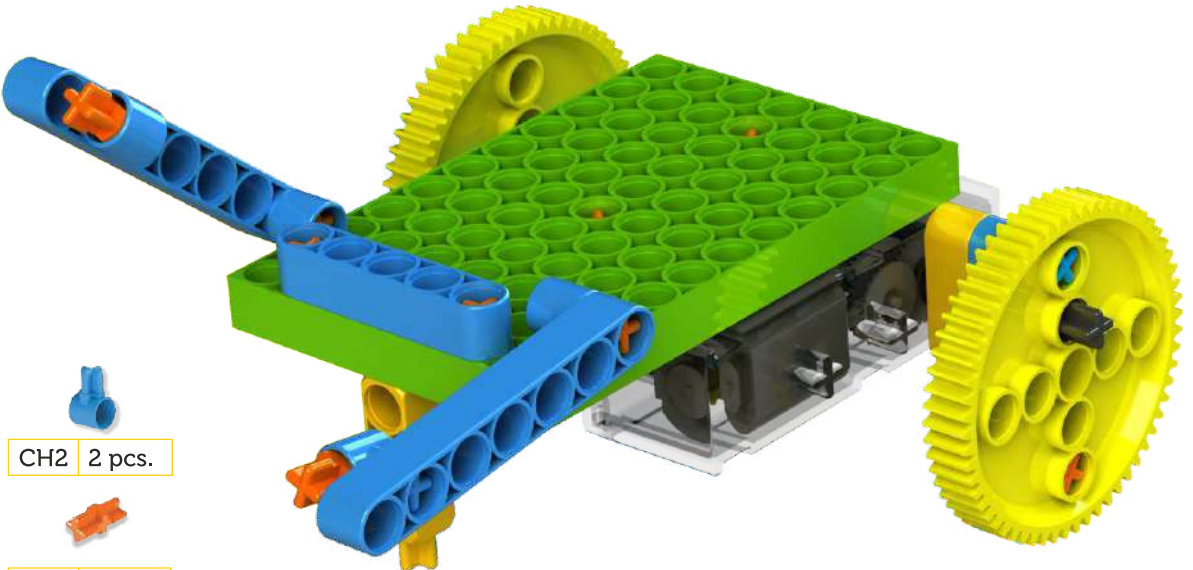

CH2 2 pcs.



CT2 2 pcs.

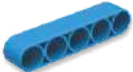

P5 1 pc.

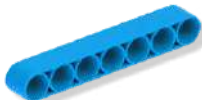

P7 2 pcs.

Step - 8

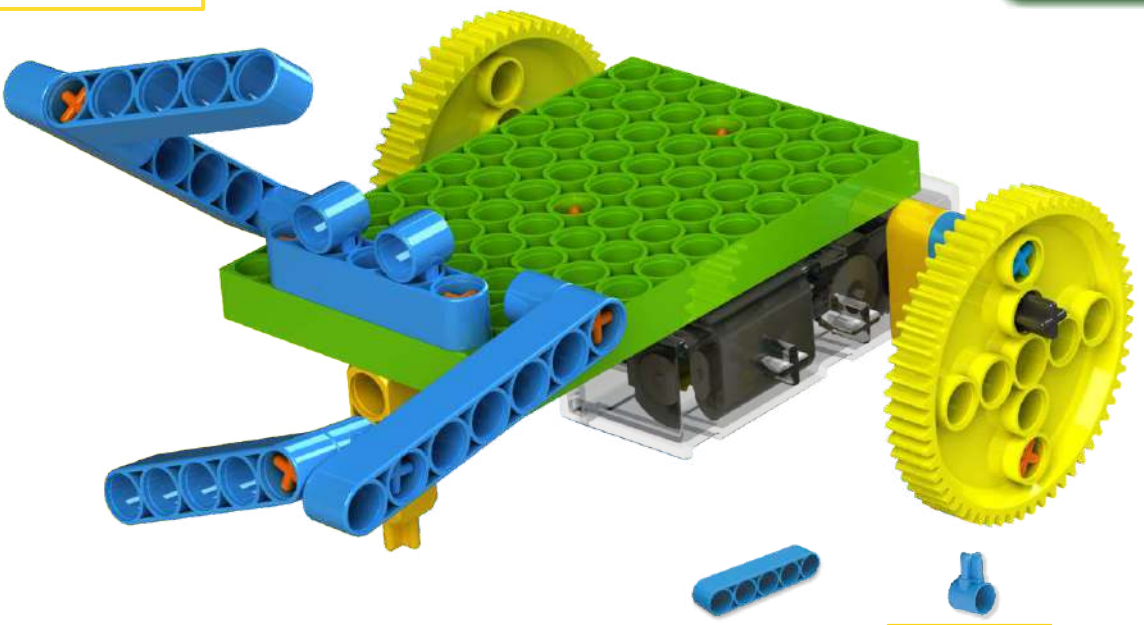

P5 2 pcs.

CH2 2 pcs.

Step - 9

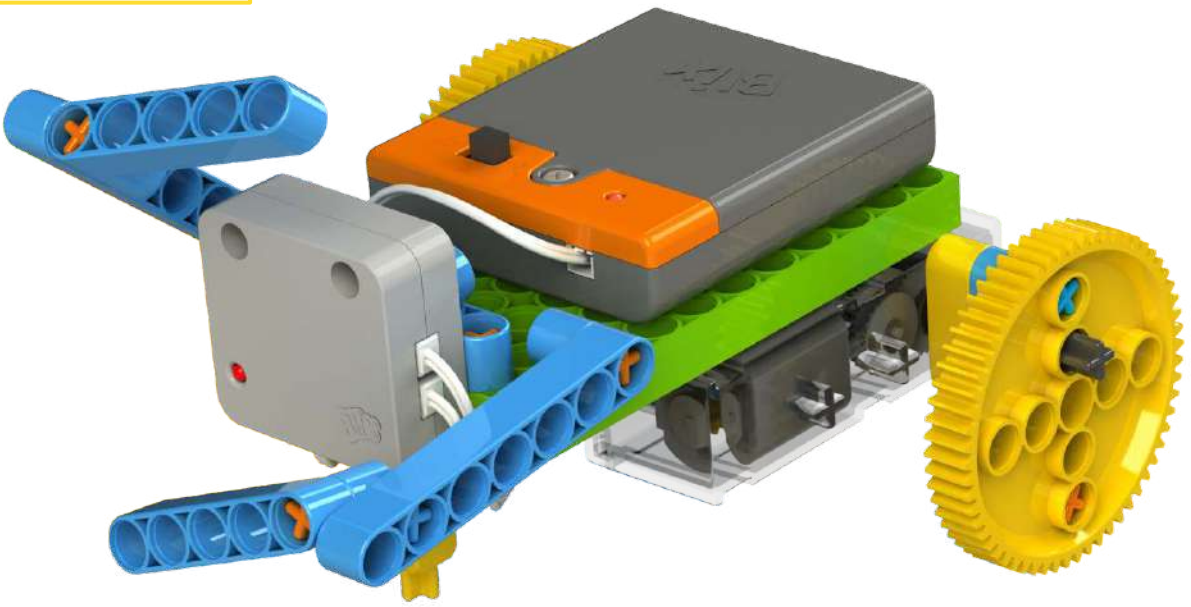

2.4GHz Receiver
1 pc.

6V Battery Box
1 pc.

2.4GHz Transmitter
1 pc.

Step - 1



CT1 2 pcs.



Motor 1 pc.

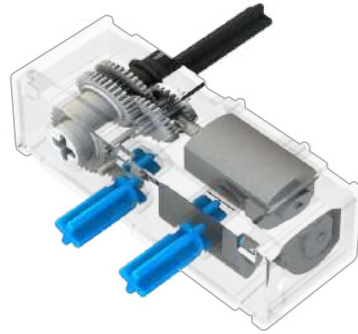

Step - 2

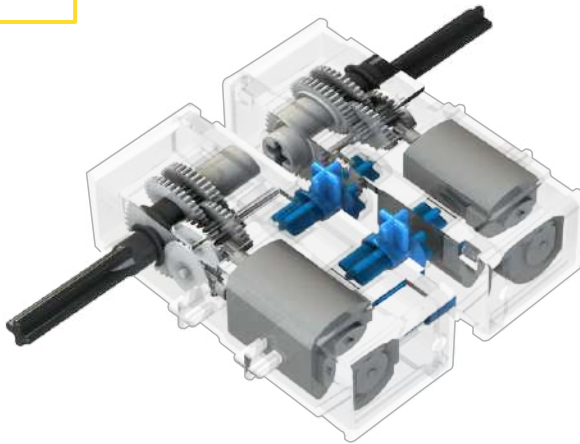

CH2 2 pcs.



Motor 1 pc.

Step - 3



TW1 4 pcs.



CT2 2 pcs.

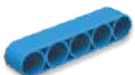

P5 1 pc.

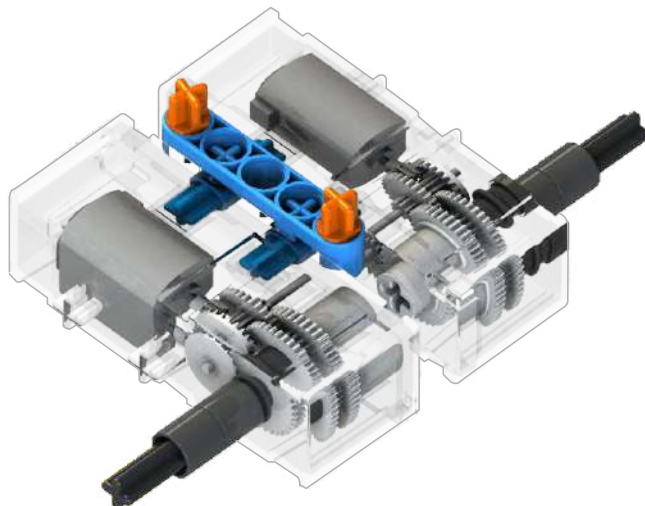

Step - 4



CH2 2 pcs.



CT2 2 pcs.



Wheels 2 pcs.



P7 X 11 1 pc.



Step - 5



TW1 4 pcs.



CH2 4 pcs.



SH60 2 pcs.



Wheels 2 pcs.

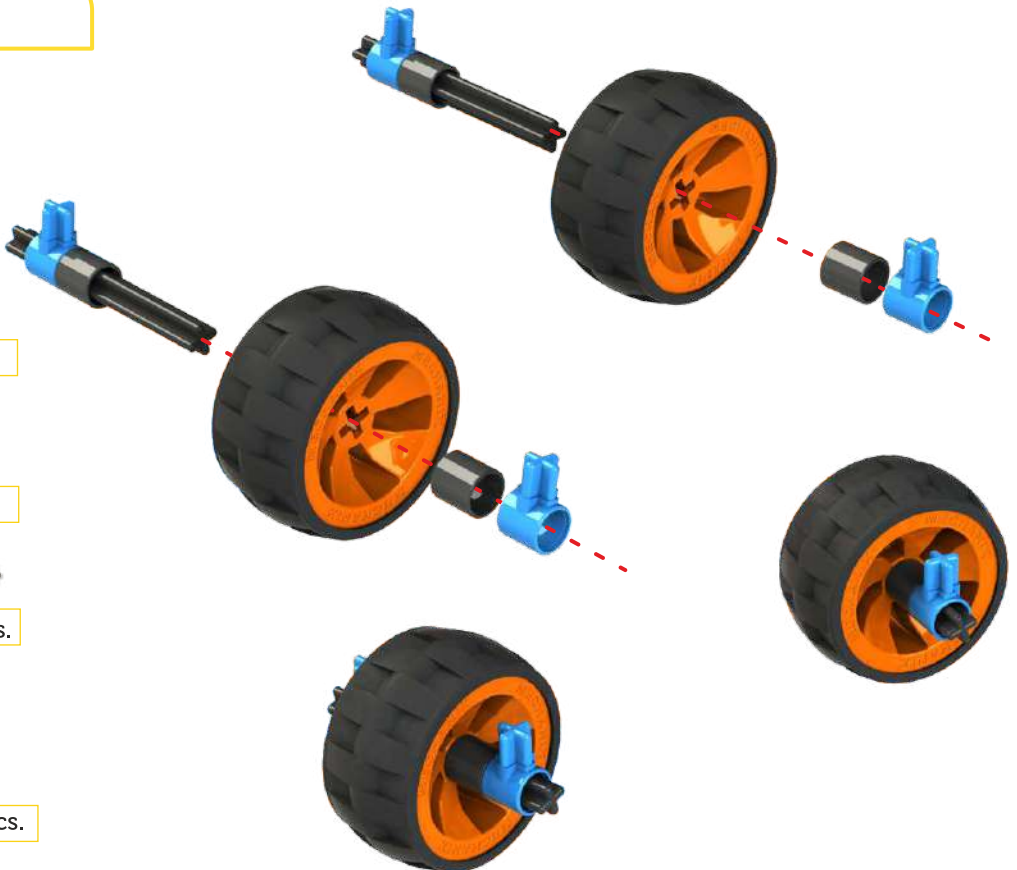

Step - 6

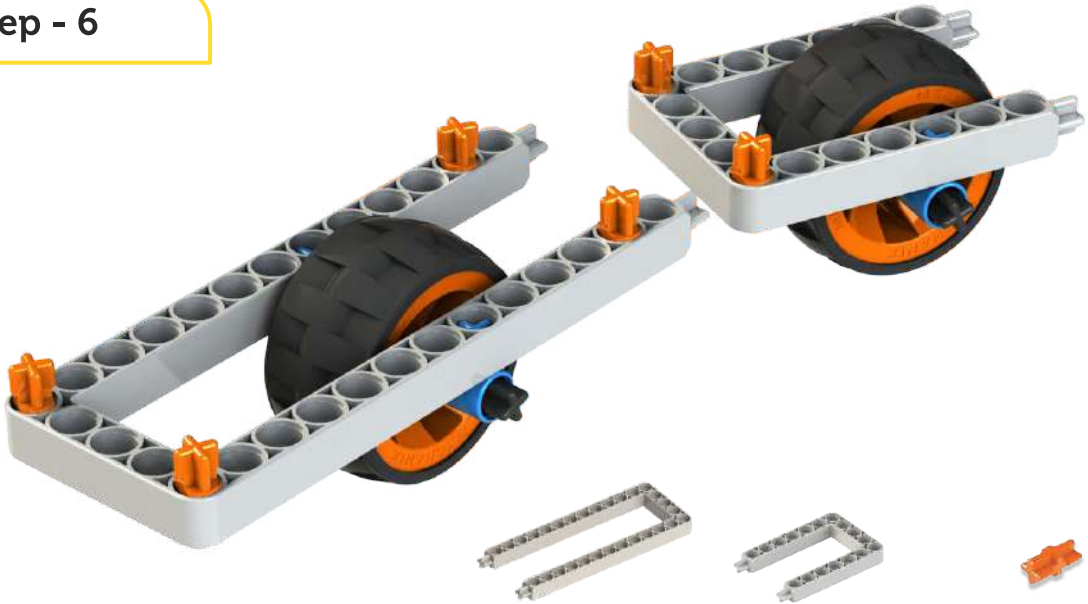

PU5 X 13 1 pc.

PU5 X 7 1 pc.

CT2 6 pcs.

Step - 7

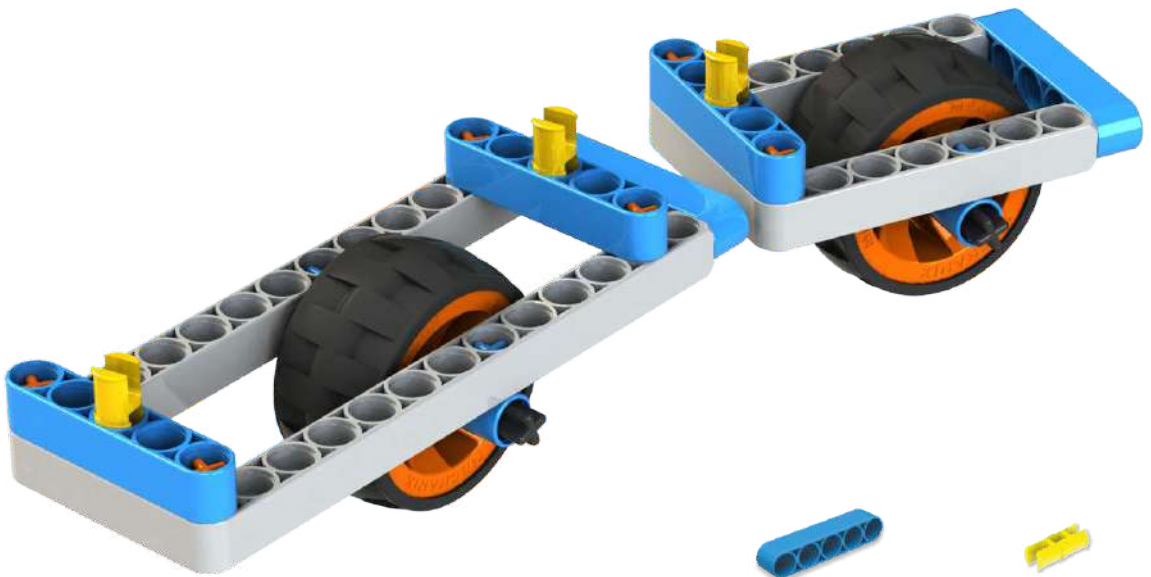

P5 5 pcs.

CL2 3 pcs.

Step - 8

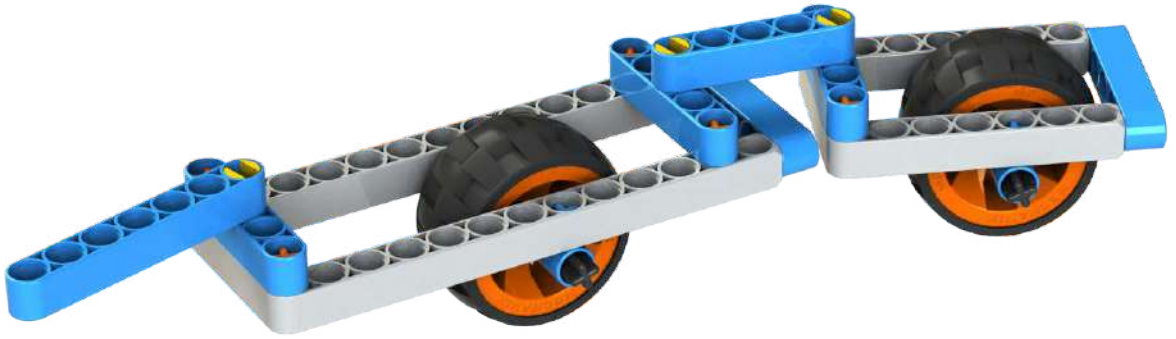

P5 1 pc.



P7 1 pc.

Step - 9

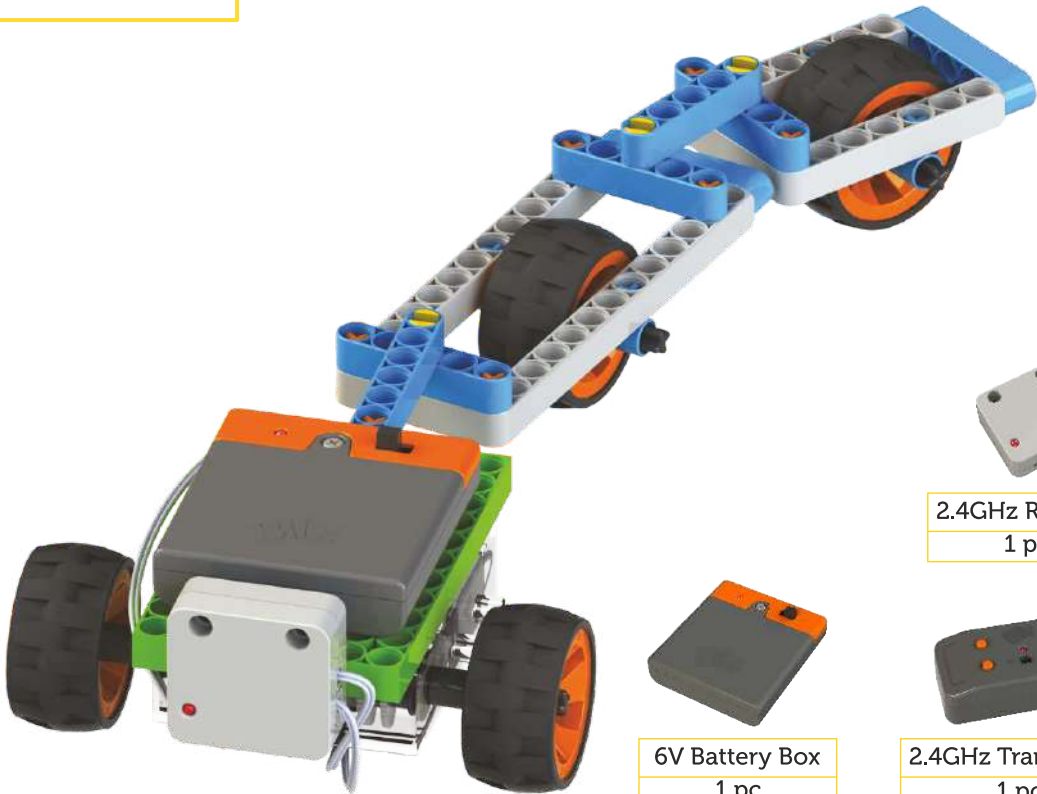

2.4GHz Receiver
1 pc.



6V Battery Box
1 pc.



2.4GHz Transmitter
1 pc.

Step - 1



CT3 2 pcs.



Motor 1 pc.

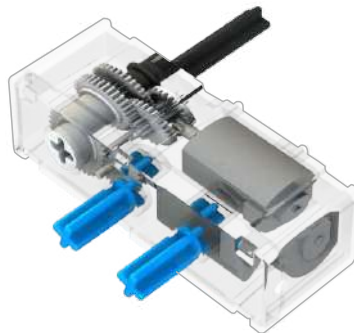

Step - 2

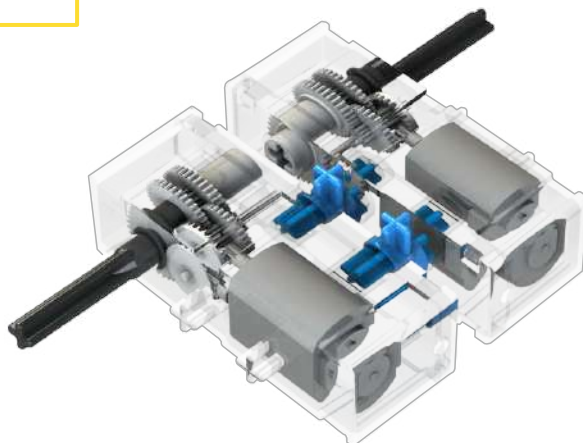

CH2 2 pcs.



Motor 1 pc.

Step - 3



TW1 4 pcs.



CT2 2 pcs.



P5 1 pc.

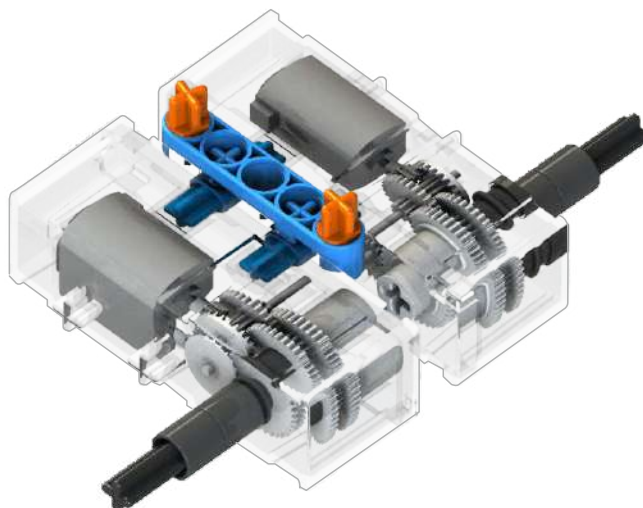

Step - 4



CH2 2 pcs.



CT2 2 pcs.



Wheels 2 pcs.

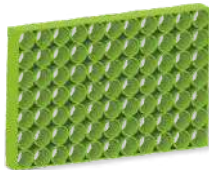

P7 X 11 1 pc.



Step - 5



TW1 4 pcs.



CH2 4 pcs.



SH60 2 pcs.



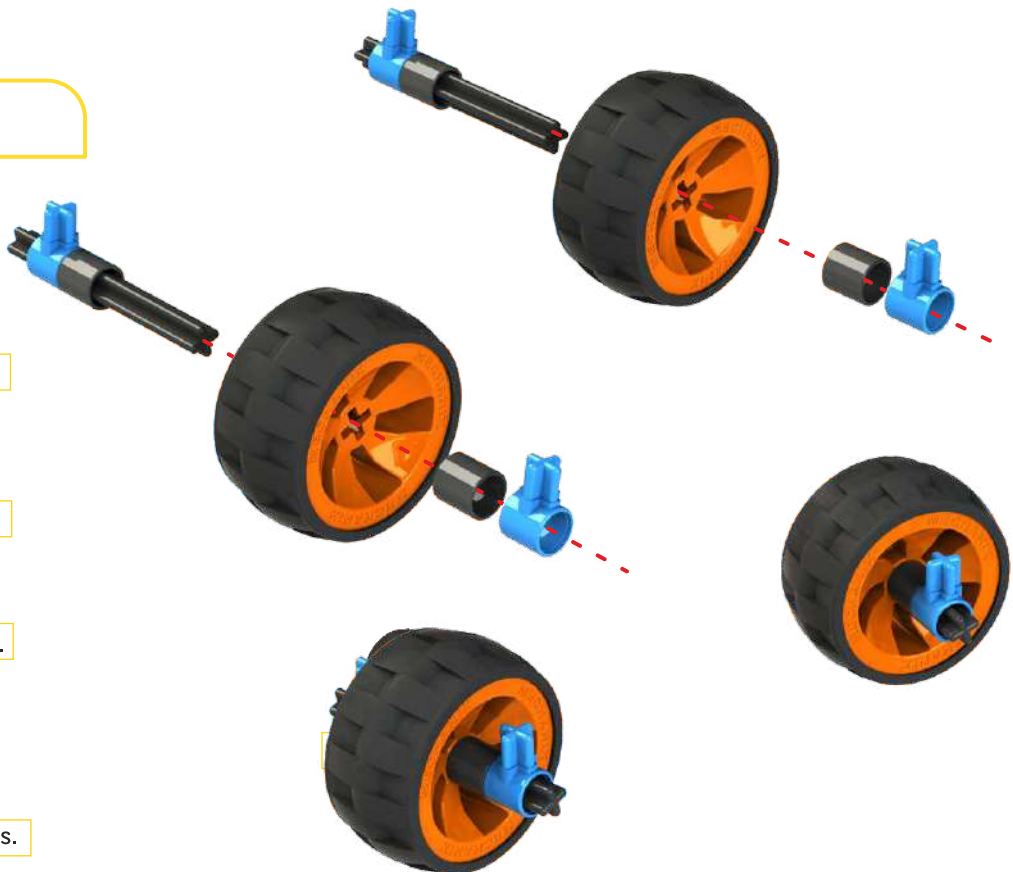

Wheels 2 pcs.

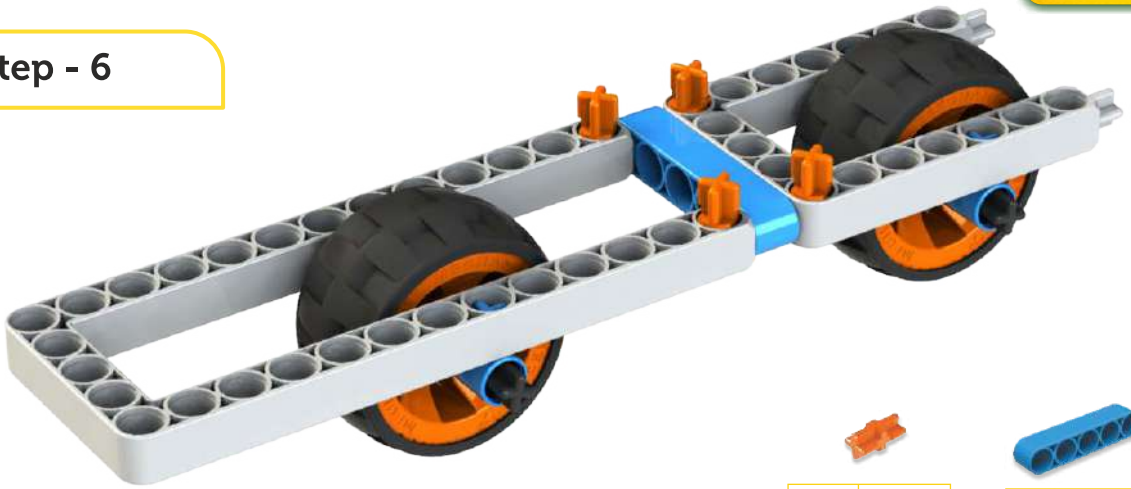

Step - 6

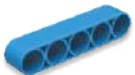

-  CT2 4 pcs.
-  P5 1 pc.

-  PU5 X 7 1 pc.
-  PU5 X 13 1 pc.

Step - 7

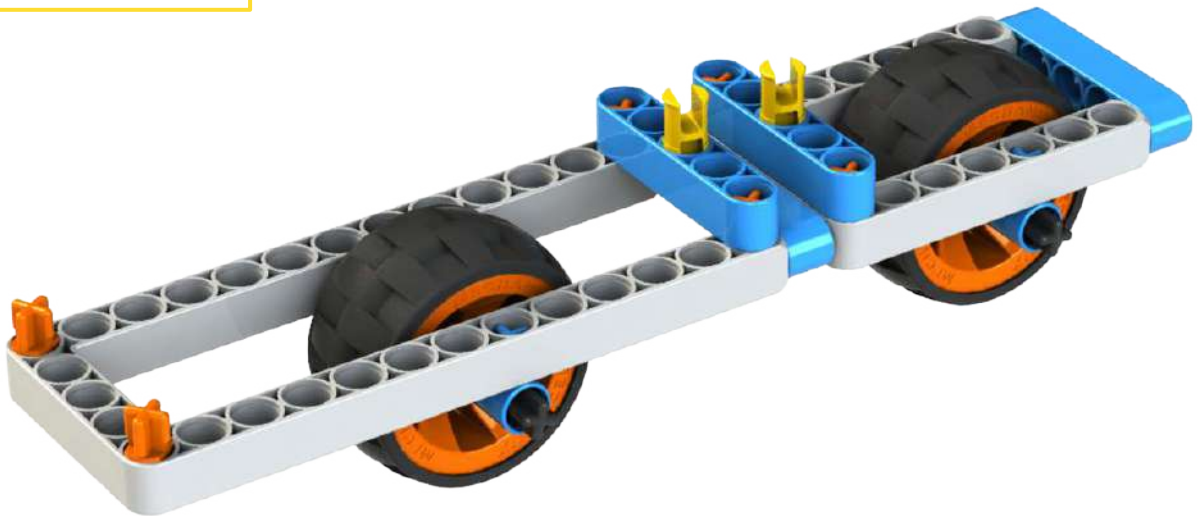

-  CT2 2 pcs.
-  CL2 2 pcs.
-  P5 3 pcs.

Step - 8

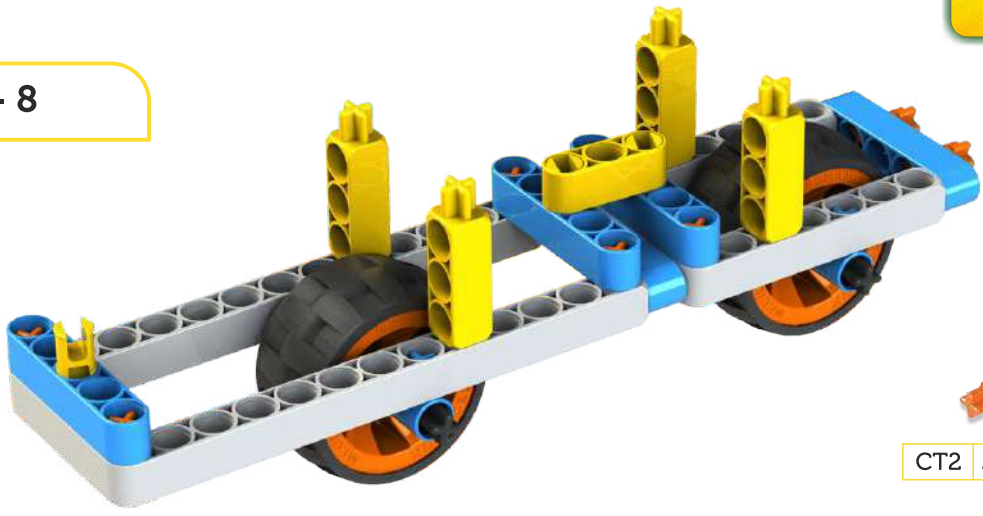

CT2 2 pcs.



P5 1 pc.



P3C2 4 pcs.



P3 1 pc.



CL2 1 pc.

Step - 9

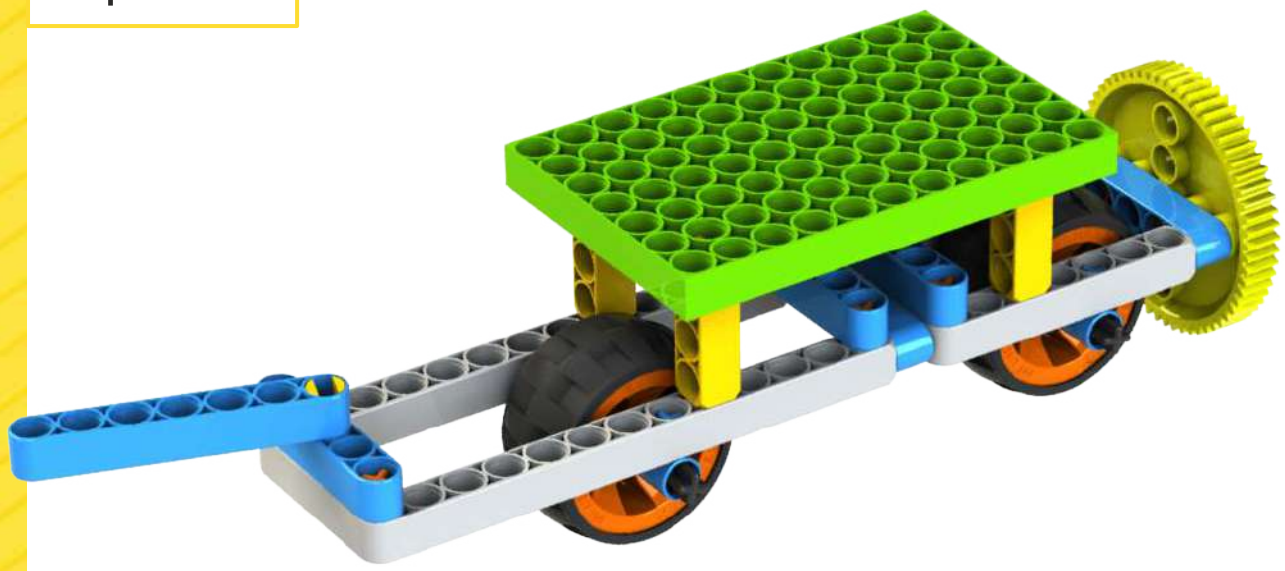

G60 1 pc.

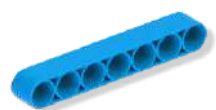

P7 1 pc.



P7 X 11 1 pc.

Step - 10



2.4GHz Receiver
1 pc.



6V Battery Box
1 pc.



2.4GHz Transmitter
1 pc.

Step - 1



CT1 2 pcs.



Motor 1 pc.

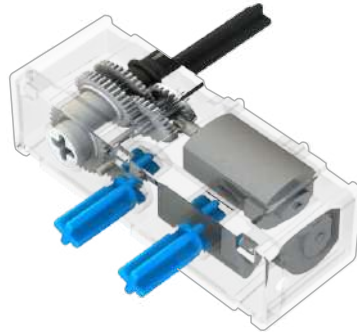

Step - 2

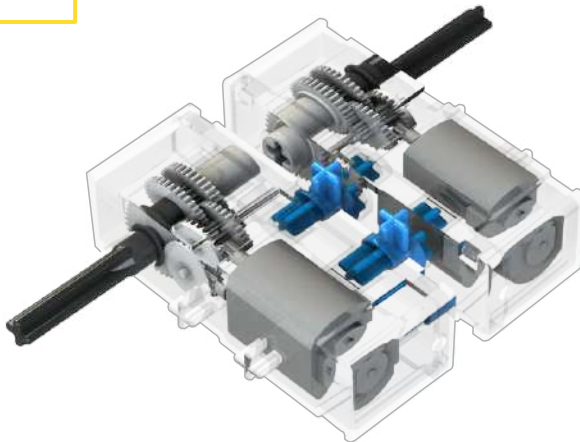

CH2 2 pcs.



Motor 1 pc.

Step - 3



TW1 4 pcs.



CT2 2 pcs.

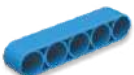

P5 1 pc.

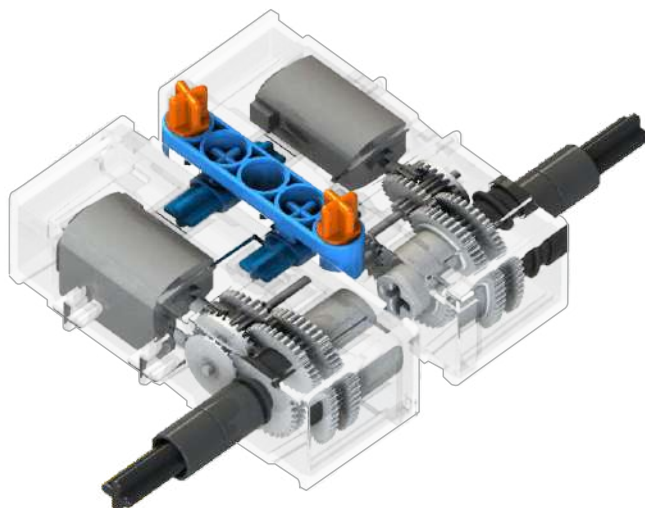

Step - 4



CT2 2 pcs.



CH2 2 pcs.



G60 1 pc.



P7 X 11 1 pc.

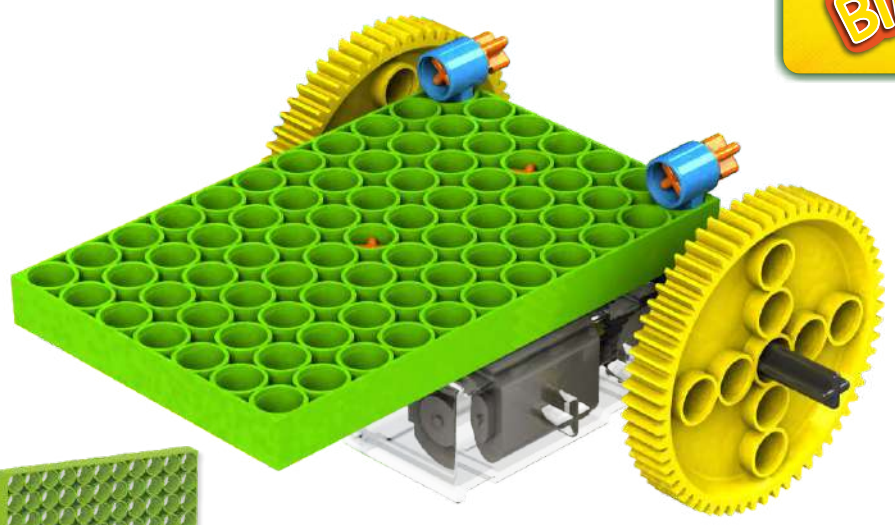

Step - 5



CT2 2 pcs.



P7 X 11 1 pc.

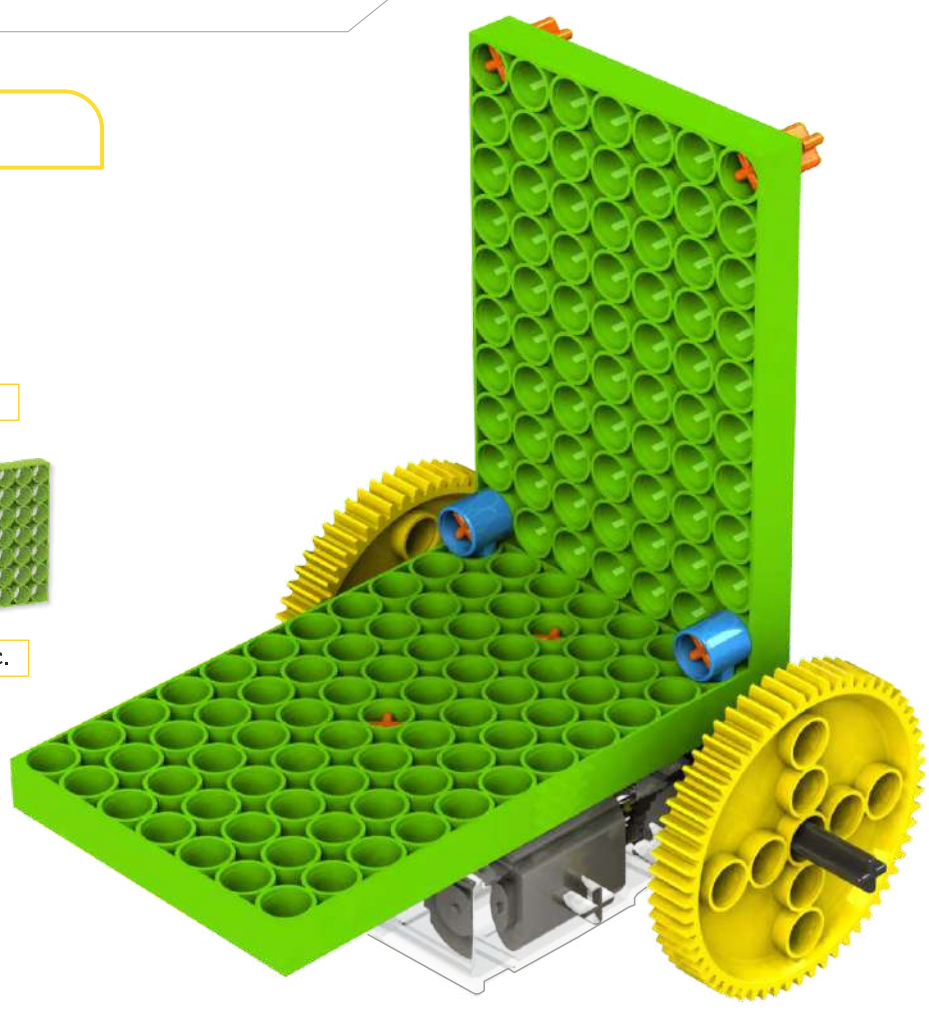

Step - 6



CH2 4 pcs.



CT2 2 pcs.



CT3 2 pcs.

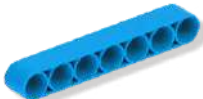

P7 2 pcs.

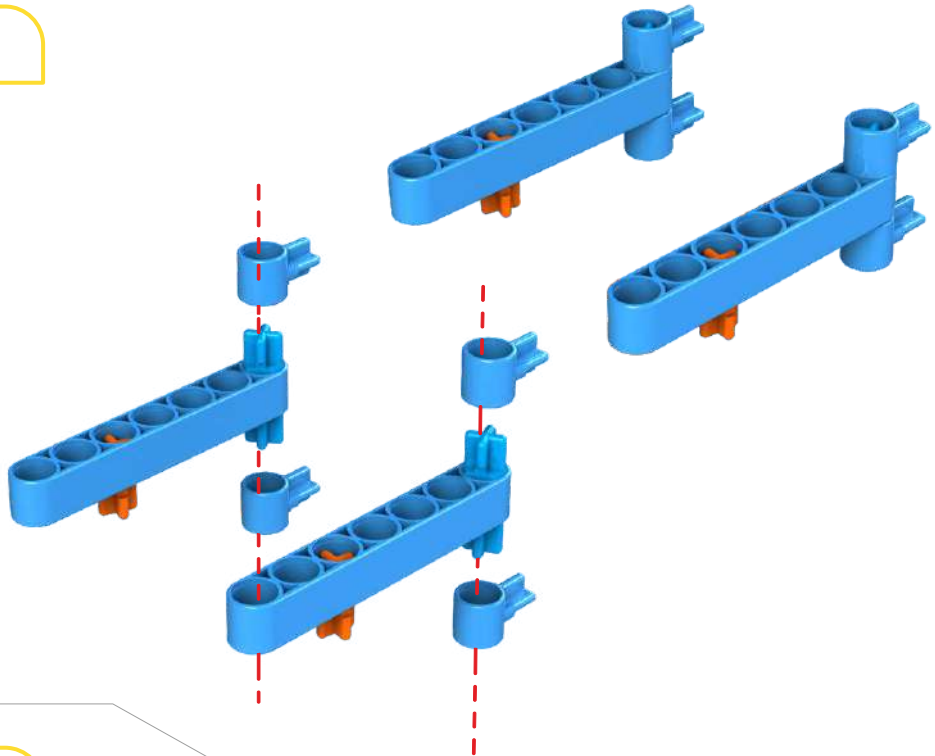

Step - 7

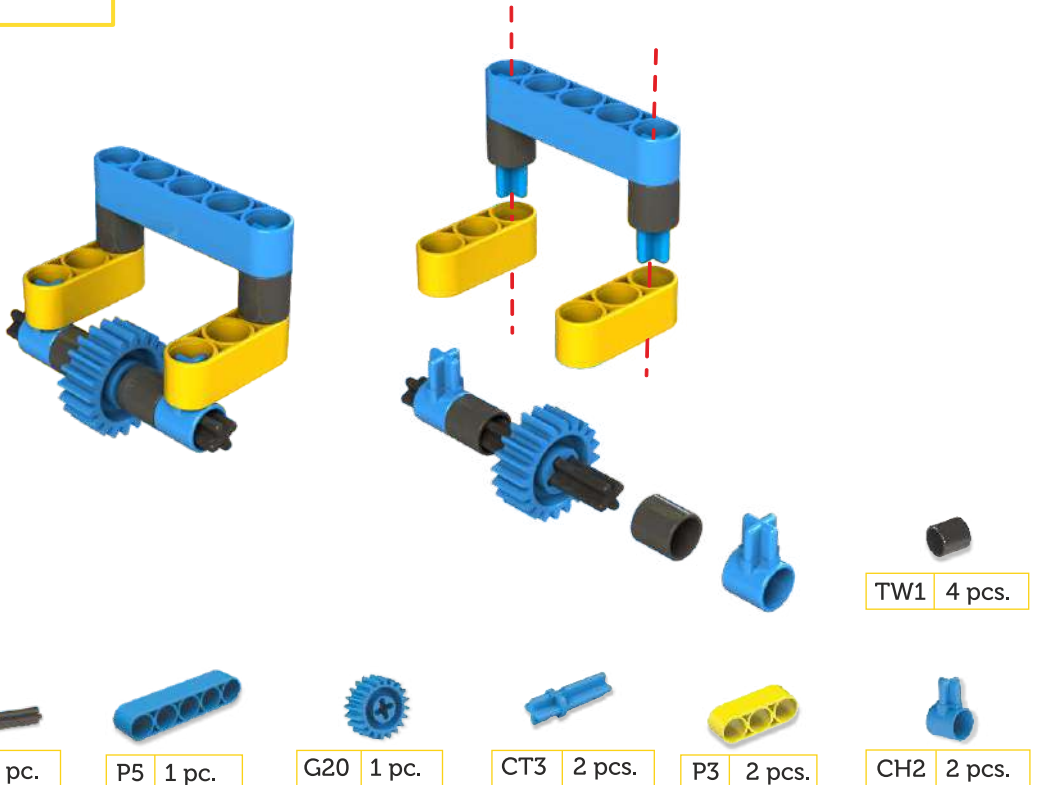

TW1 4 pcs.



SH60 1 pc.



P5 1 pc.



G20 1 pc.



CT3 2 pcs.



P3 2 pcs.



CH2 2 pcs.

Step - 8

Assembly of step 5 & Step 6



CH2 4 pcs.

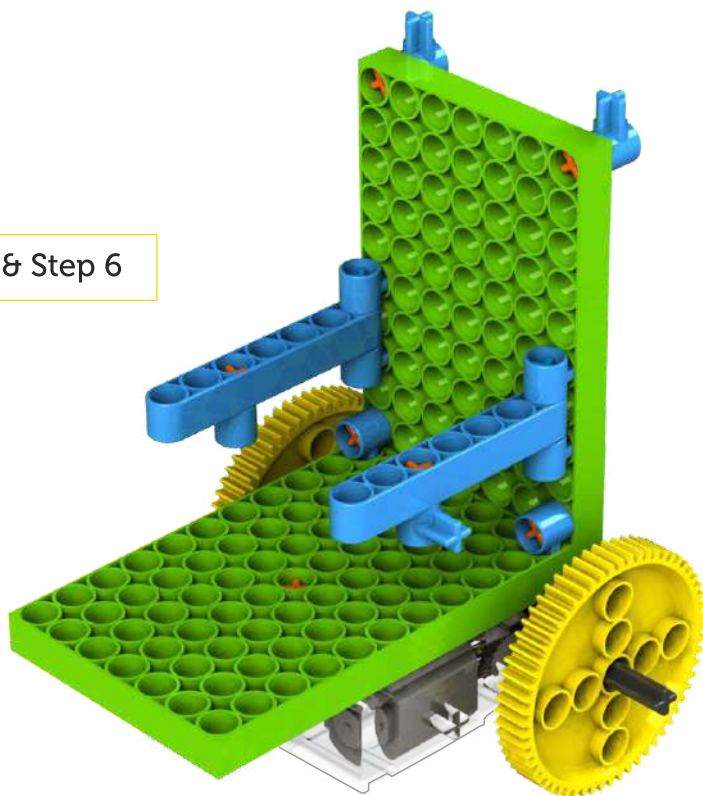

Step - 9



CL2 1 pc.



P3 2 pcs.

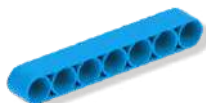

P7 2 pcs.



Step - 10

Assembly of step 7 & Step 9



Step - 11



2.4GHz Receiver
1 pc.



2.4GHz Transmitter
1 pc.



6V Battery Box
1 pc.

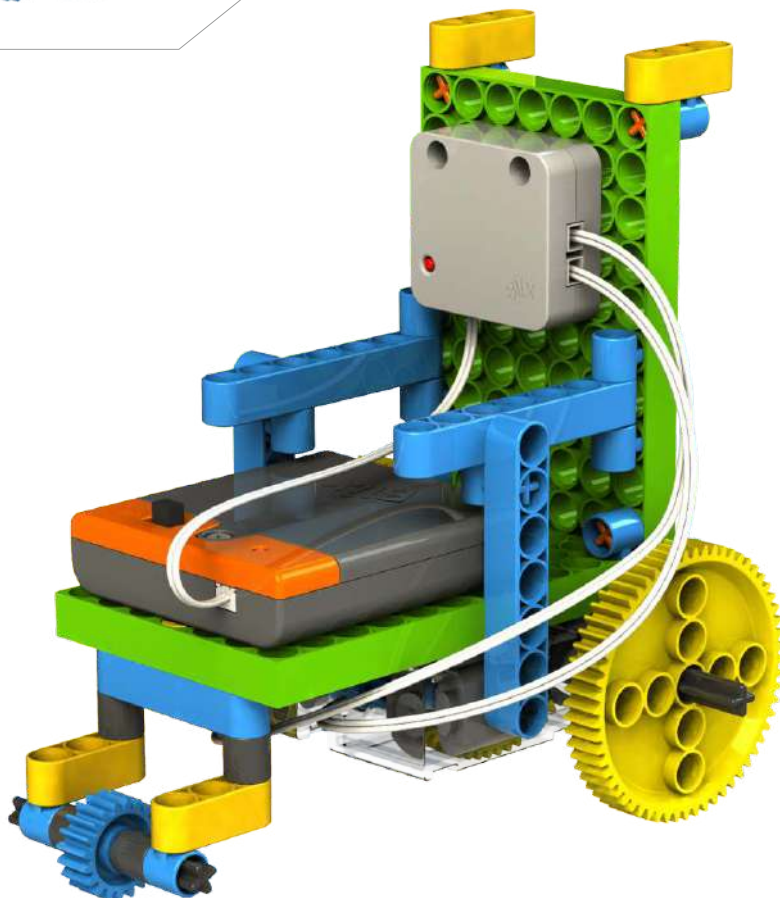



CT2 20 pcs.



CT3 12 pcs.



CL2 10 pcs.



CH2 18 pcs.



TW1 12 pcs.



P3C2 4 pcs.



P3 4 pcs.



P3 Plus 4 pcs.



CT 1 X 2 1 pc.



P5 7 pcs.

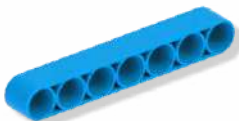

P7 6 pcs.



P11 1 pc.



PU5 X 7 1 pc.



PU5 X 13 1 pc.



G(20) 6 pcs.



G(20) Idler
6 pcs.



G60 2 pcs.



Wheels 4 pcs.



SH60 5 pcs.



P7 X 11 2 pcs.



2.4GHz Transmitter
1 pc.



2.4GHz Receiver
1 pc.



Motor
2 pcs.



6V Battery Box
1 pc.



Remover Tool 1 pc.