

KAHUNA  CHAIR®

KAHUNA MASSAGE CHAIR

SM9300

MANUAL





CONTENTS



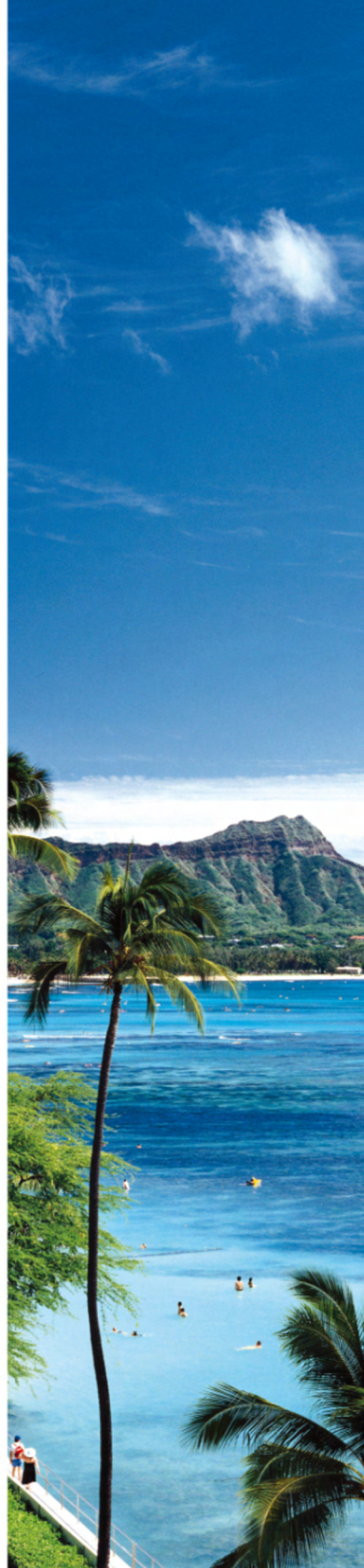

Please read and follow all safety instructions listed in this user manual prior to use. Basic precautions should always be considered when operating an electrical appliance.

Safety Instructions	2
Product Components	7
Chair Installation	10
Remote Controller	15
Operation Guide	16
Maintenance	28
Troubleshooting	29
Product Specifications	30



- Please read this manual carefully to make sure the installation and operation of the massage chair is done correctly.
- "Safety Instructions" are provided for important safety information. Both Warning and Caution are important safety caution, please be more cautious.

	Warning	This sign indicates warning of causing possible death or injury to body.
	Caution	This sign indicates caution of causing possible pain or damage to body.

	This sign indicates forbidden behavior.
	This sign indicates must follow instruction to operate.
	This sign indicates self disassembly is forbidden.
	This sign indicates correct operation of cable.

- The following should be kept for any further references.

SAFETY INSTRUCTION



Warning

	<ul style="list-style-type: none"> • Osteoporosis patient ; • People with heart disease including embedded pacemaker or other medical electronic device inside the body ; • For pregnant women or people with health issues, please consult with doctor before use ; • Patients with a high fever forbid to use this machine. • Perceptual disabilities patients forbid to use this machine. • People over 80 years old forbid to use this machine. • Kids are not allowed to use the chair ; • Don't operate the chair after the use of alcohol. • Please don't sleep in the chair. • Don't use the chair when your body is wet. 	<p>People who are not suitable to use the chair</p>
	<ul style="list-style-type: none"> • Make sure there are no kids or pets or other objects around (under, behind or in front of) the chair at the moment of backrest, leg-rest up/down or leg-rest retraction/extension from reclining position. • During operation, if body is being abnormal, please stop the operation and go consult with your physician. • Please do not take strong massage on the head. • Do not massage belly or knees, be careful when massaging neck. • Children or pets are not allowed to play on the chair especially during massage. Standing or sitting on the back or armrest is not allowed either. • Those who move around with difficulty or can't express themselves must be taken care of strictly and continuously during massage. 	<p>Accident /injury</p>
	<ul style="list-style-type: none"> • Insert the plug of the chair into correct and suitable power socket. • Make sure the plug is completely inserted into the socket to reduce short circuit or fire risk. • Unplug the power when not in use, stop all massage functions and turn off on/off key before unplugging. 	<p>Fire and electric shock</p>
	<ul style="list-style-type: none"> • Massage cushions of the chair are not allowed to fold for storage. • The machine is forbidden for no-load running for a long time. 	<p>Accident</p>
	<ul style="list-style-type: none"> • Power cord, plug, socket can't be used in broken or loose contact condition. • Don't use other electric power except rated voltage in case of fire, electric shock or any breakdown. • Any broken, re-process, knotted, twisted power cord or pressed under heavy cargo is not allowed to use. 	<p>Fire and electric shock</p>



Warning

	<ul style="list-style-type: none"> If the chair is dysfunctional, or is broken, splashed with water or falls into water, please have it repaired by professional repairman or send the chair to assigned service agent. Self-modification, disassembly or maintenance is forbidden. If power cord or plug is damaged, please don't replace it yourself, please contact us or appointed dealer for replacement. To avoid electric shock or body injury, please don't open or disassemble any part of the chair, there is not any attached part of the chair for maintenance by customers. Check leather or cloth material on the back and other areas is broken or not. If broken, even though it is small, please stop using the chair, unplug the power and have it repaired. 	<p>Disassembly and maintenance</p>
--	--	------------------------------------





Caution

	<ul style="list-style-type: none"> Please operate the chair when it is flat or on leveled place 	To avoid sudden falling.
	<ul style="list-style-type: none"> Position the chair 4 inches from the wall to allow for sufficient space to recline up and down. 	To make sure the back lying.
	<ul style="list-style-type: none"> The maximum suggested operating time is 20 mins. 5 mins for each position beginning with the slight- step massage. Along continuous massage in the same position may cause uncomfortable feeling. 	Too long time massage is bad for your body.
	<ul style="list-style-type: none"> Before sitting on the chair to avoid injury please inspect everything to confirm that the massage heads are in the correct position. 	To avoid accidental injury.
	<ul style="list-style-type: none"> Please make sure that the power switch is on "OFF" position before inserting the plug into the socket. 	
	<ul style="list-style-type: none"> Turn off all controls before removing plug from outlet. 	To avoid the accident when turn on the power.
	<ul style="list-style-type: none"> Make sure the plug is completely inserted into the socket. 	
	<ul style="list-style-type: none"> Checking whether there are any damages on the wire and make sure there are no water or rubbish on the wire. 	To reduce short circuits and any fire hazard.
<ul style="list-style-type: none"> Installing the wire in a correct way. The plug must be inserted into socket with the connect, the connect couldn't be bent or cut off. 		To avoid electric shock in any leakage or breakdown.
	<ul style="list-style-type: none"> Don't use or store the chair in the wet environment like near the swimming pool, or bathroom. Keep the chair and remote control dry at all time. Don't use the chair when your body is wet. 	<p>To avoid leakage or electric shock.</p>

SAFETY INSTRUCTION

Caution

	<ul style="list-style-type: none"> • Don't press with hands or step on the massage heads with feet. • Don't put hands between the working massage heads. Don't put hands or feet in the gap of mechanical parts. Don't drop or insert anything into the slot of massage chair. • Don't stand or sit or put anything on the backrest, armrest, or leg-rest. • Don't stand on the chair during operation. Don't move the chair during operation. • Don't pull out the plug or turn off the power during operation. Don't put your hands or head between leg-rest or beneath. Don't use the massage chair while wearing hair ornaments. Don't put hard things in pocket when take buttocks and huckle massage. • Don't sit or press on the backrest when the chair is in reclining position. • Don't use on bare skin or wearing thin clothes, thin clothes may cause better massage effect, But it also may cause irritation to the skin or cryogenic burns. 	<p>To avoid accidents or injury</p>
	<ul style="list-style-type: none"> • Keep the chair away from heat, wet, sharp things and corrosive, inflammable, explosive environment. • To use electric blanket or other heating products on the chair is forbidden. • Don't put in the space of dust serious or corrosive gas environment. • Don't put the chair in a small space places or use in the bad air circulation places. 	<p>To avoid fade, discolor on upholstery or hardened, deteriorated on PU.</p>
	<ul style="list-style-type: none"> • Keep the chair away from stove or other heating products. • Don't put the chair directly under the sun or other high temperature places. • Don't use the chair in outdoor. 	<p>To avoid electric shock.</p>
<ul style="list-style-type: none"> • Make sure to install the wire in correct way(Incorrect install way may cause electric shock. If you don't know how to install, please find a professional electrician) • Don't use plug adapter (If the enclosed plug doesn't match with socket, please don't change the plug by yourself and find a professional electrician to install a matched socket.) 	<p>To avoid electric shock.</p>	

Caution

	<ul style="list-style-type: none"> • Unplug the power before cleaning the chair. • Unplug the power after using the chair. 	To avoid electric shock or fire hazard.
	<ul style="list-style-type: none"> • Unplug the power when any damage on the power. 	
	<ul style="list-style-type: none"> • Hold the plug to unplug the power but to not try to pull the wire to unplug the power. 	To avoid accidents
	<ul style="list-style-type: none"> • Please turn off the power switch and unplug the power after massage. 	
	<ul style="list-style-type: none"> • Unplug the power immediately when electricity goes off. 	To avoid damage or accidents when power on again.



- Warning :
- 1.Do not use it when wet.
 - 2.The disabled may need supervision.
 - 3.The chair has heat function, people who are insensitive to heat must pay high attention.

| Grounding instruction |

The chair is equipped with a cord having a grounding conductor. The plug must be plugged into an appropriate socket that is properly installed and matched with the plug.



Earth wire is not allowed to be in these places

Gas pipe: probably cause explosion or fire.
 Phone wire and lightning rod: probably cause electric shock and fire when thundering.
 Water pipe: earth wire is useless where there are plastics

PRODUCT COMPONENTS

| Main body diagram (Front) |

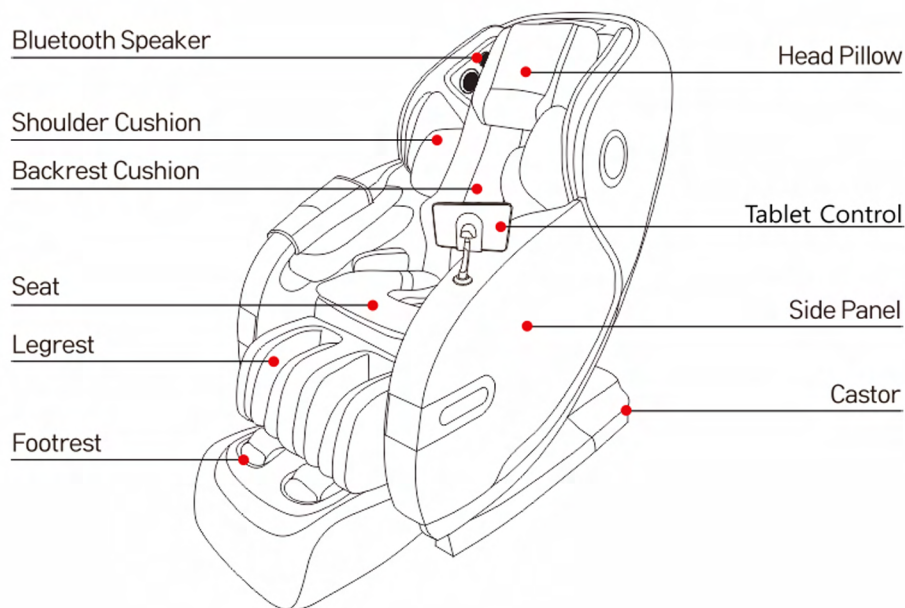

| Main Body Diagram (Rear) |

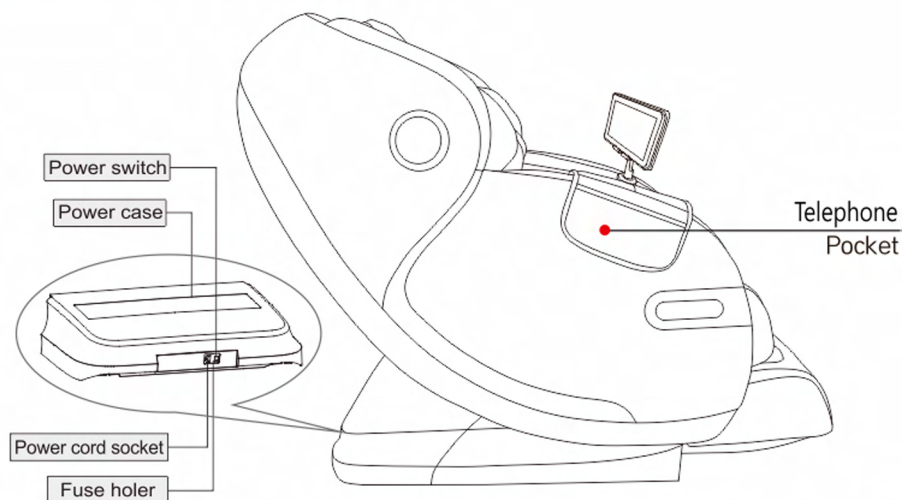

| Internal Structure |

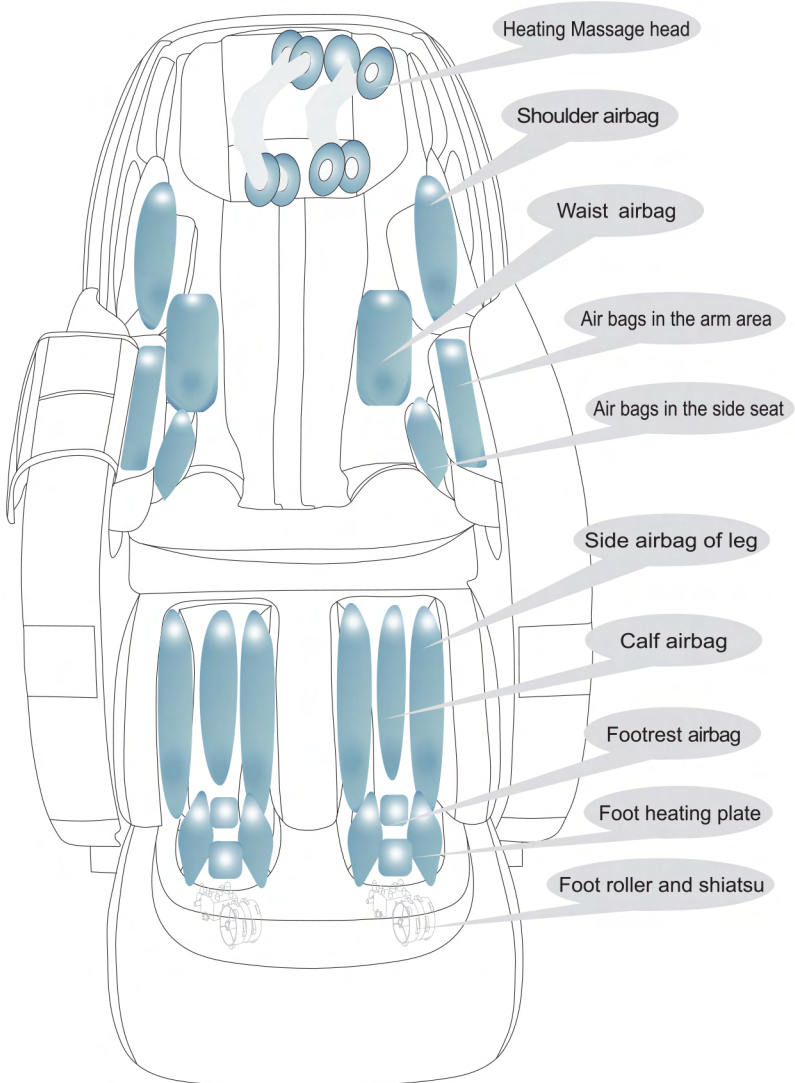

PRODUCT COMPONENTS

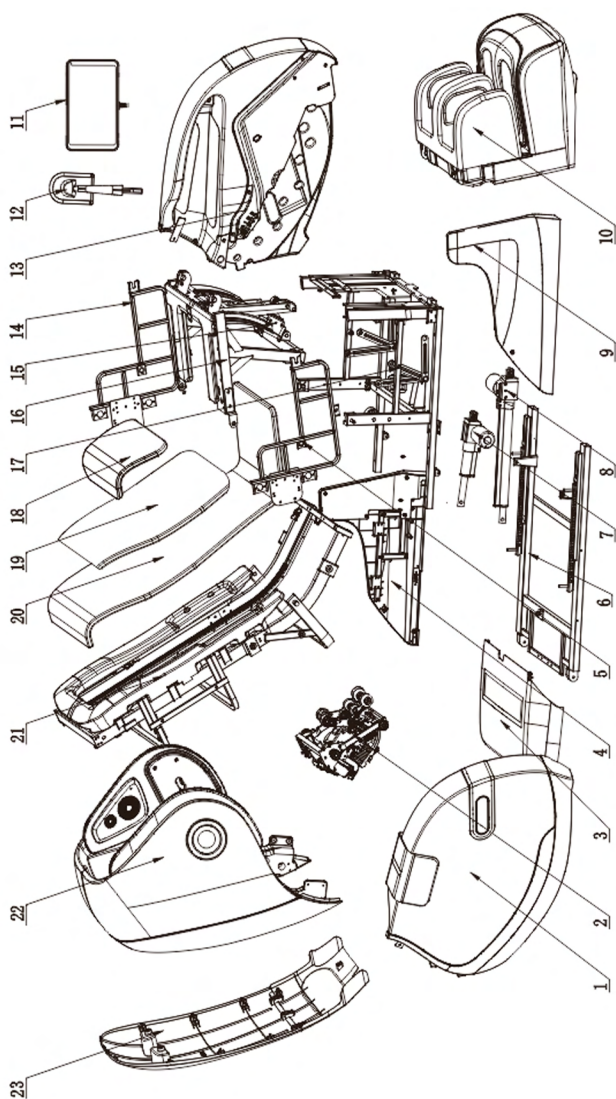

- 1 Right armrest assembly
- 2 Massage machine
- 3 Power case assembly
- 4 Left side fender
- 5 Right armrest frame assembly
- 6 Under frame assembly
- 7 Seat electric actuator
- 8 Backrest electric actuator
- 9 Right side fender
- 10 Foot and leg assembly
- 11 Tablet Control
- 12 Tablet support pole
- 13 Left armrest assembly
- 14 Left armrest frame assembly
- 15 Footrest electric actuator
- 16 Seat frame surface assembly
- 17 Seat bottom frame assembly
- 18 Pillow
- 19 Shoulder pad
- 20 Back and seat cushion
- 21 Backrest assembly
- 22 Shoulder device assembly
- 23 Back cover assembly

1. Remove the package and take out the chair parts and components



Remove the carton.

Take out the packing material.

Take out all parts including component list below with seat cushion and pillow.

*The spare parts include remote control, holder, user manual wheel, power cord.

Components

1. A screw driver and Allen-wrench is needed to complete installation.
2. Allen wrenches are included in the parts bag, but you will need a screw driver as well.
3. Please remove Velcro-cover when you attach Velcro.
4. Extra Foot Paddings for softer foot massage are included for personal preference.



Head pad Controller bag Electric power cable The left /right armrest exterior parts Back seat cushion

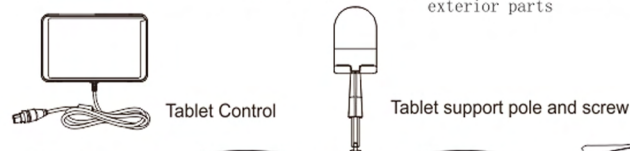

Tablet Control

Tablet support pole and screw

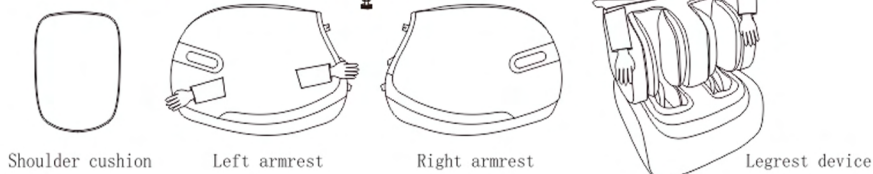

Shoulder cushion

Left armrest

Right armrest

Legrest device

CHAIR INSTALLATION

2. Install the legrest |

1. Unscrew the bolt from hanger of legrest.

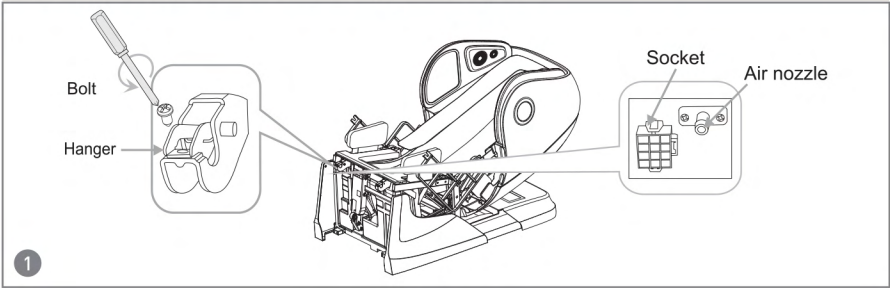

2. Connect the legrest's air hose with the corresponding air nozzles of the main body tightly.

3. Connect the cable plug and the socket.

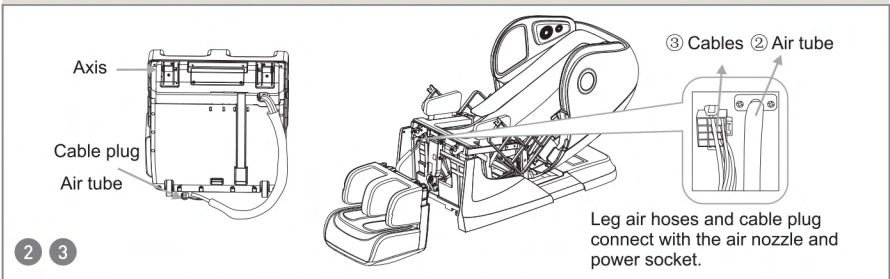

4. Raise the rotation shaft board on hangers, raise the legrest with hands, put rotation shaft into hangers on main body, and put rotation shaft board down.

5. Screw it back tight.

6. Connect the legrest leather piece with seat by velcro.

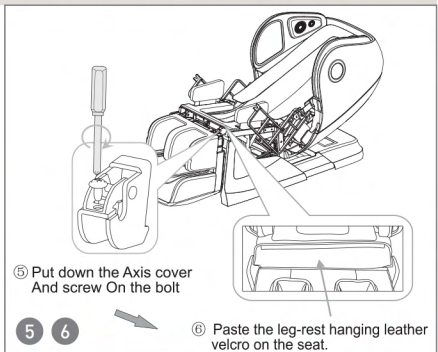
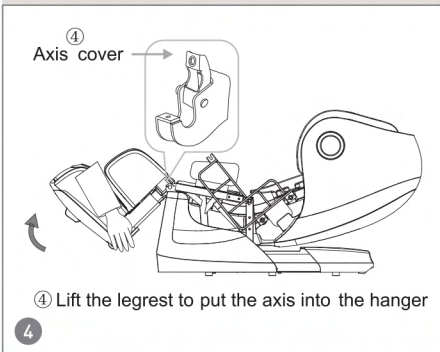

Attention: When connecting the air pipe and cables, don't twist the air pipe and cables together.

CHAIR INSTALLATION

3. Install the side arm panel |

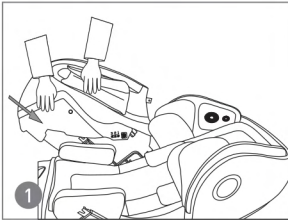
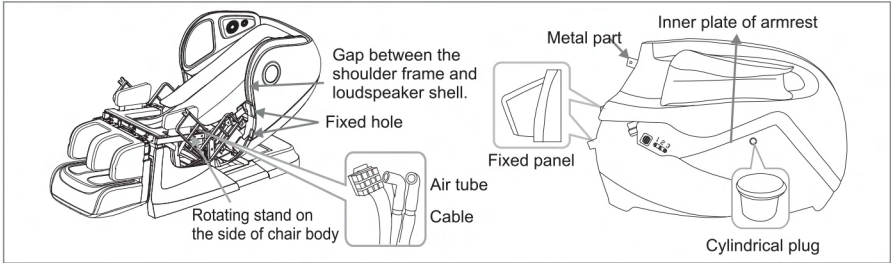

1 Lift the front armrest and push the cylindrical plug into the rotating stand on the side of the chair body and push back.

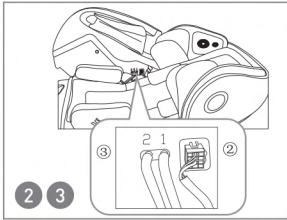

2 Put the cable plug into the connector.

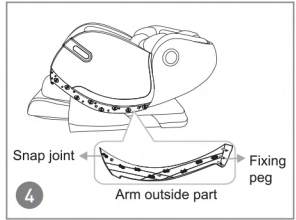

4 Insert the 3 fixing peg of the arm outside part into the 3 fixing holes of the front bottom armrest, and buckle 8 snap joints in place.

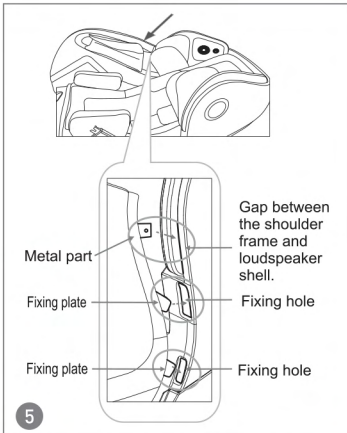

5 Insert the 2 metal fixing part of the back armrest into the fixing hole on the back main body, and insert the up fixing part into the gap between shoulder frame and loudspeaker shell.

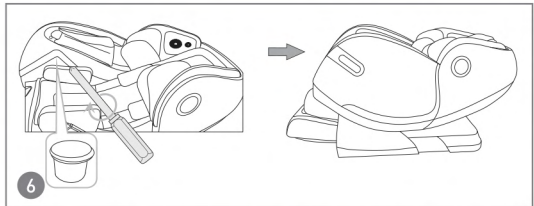

6 Remove the rubber plug of the armrest, spin the screws inside the hole tightly then put on the rubber plug tightly.

Reminder : when installing the left armrest, there's no cable, only install the air tube is ok.

CAUTION

Do not squeeze the air tubes during the installation. This may cause air leakage or the air bags not inflatable. Please make sure that the fixed plate and wire need to be plugged firmly, otherwise the armrest may drop or USB can't charge.

CHAIR INSTALLATION

4. Install the controller and the seat cushion

- ① Insert the Velcro of seat pocket through the upper position of arm airbag installed in right armrest, paste it on another Velcro, then you can put your telephone, watches and key ect. in this pocket for easy using.
- ② Insert the tablet supporting pole into the left armrest, when inserting please according to the shape between the pole and the hole on the armrest.
- ③ After insert the support pole, using M6*16 screw tight it from the upper air bag of the armrest.
- ④ Put the tablet on the support pole.
- ⑤ Connect the tablet line into the massage chair with the line socket which on the left side of the seat part, then tight the screw nut.

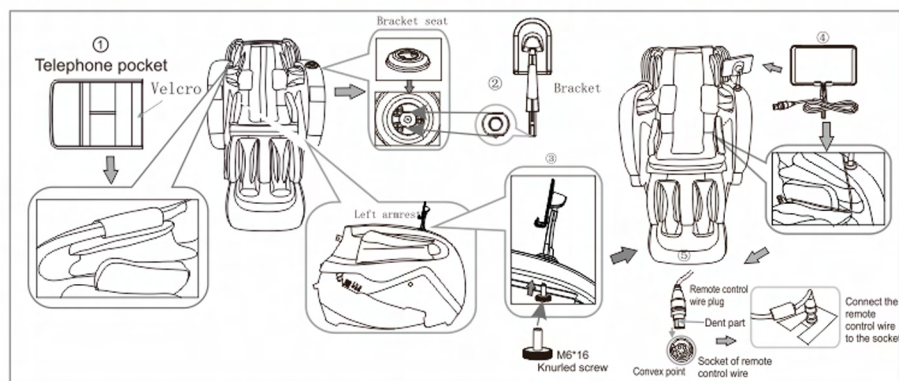

Put the back seat cushion, shoulder cushion, head pad onto the backrest and connect the two parts with zipper and velcro.

★ Warm tips

In order to get exact correct body test data for comfortable massage effect, when you sit on the chair, please make the bottom rim of the head pad flush with your ears before zippering the said two parts.

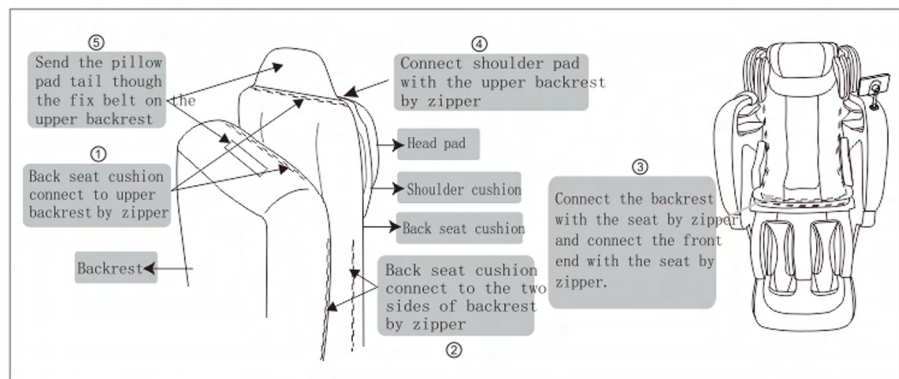
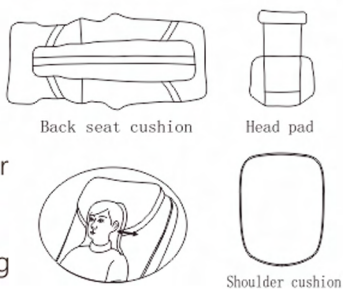

5. Moving the massage chair

After completing the installation, put the chair in incline / upright position to move the chair easily.

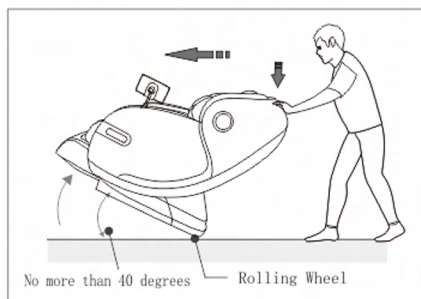

- As illustrated, tilt the chair back onto its wheels at 40° angle. Slowly push and maneuver the massage chair to desired location. Lower massage chair slowly and smoothly until it is fully flat on the ground.

6. Place the massage chair in an open area

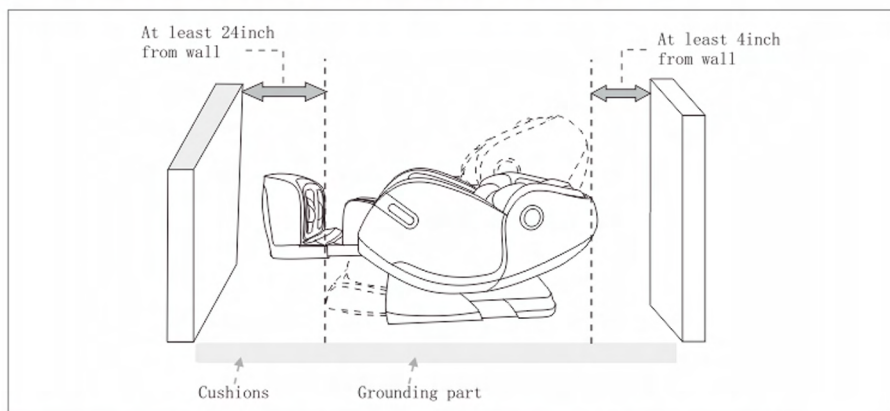

Because the chair is heavy, it may ruin your floor in long time setting. Please put a blanket or other soft things to protect your floor.

CAUTION

- * Don't use the chair in wet places like near swimming pool , bath room to avoid leakage or electric shock.
- * Please use chair in flat place to avoid chair falling or noise or other unexpected trouble.
- * Don't use under sunlight or near stove or other heating place to avoid upholstery deteriorated.

| Tablet Remote |

Top Face of Tablet Remote Control



Tablet Remote Control

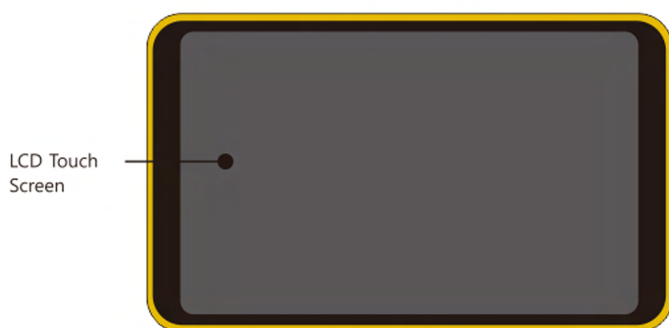

1. After the chair is powered on, the tablet will turn on by default and display the boot interface. After a while, enter the main interface and press the power switch at the right end of the top face of the tablet to turn on/off the display of the tablet.



Main Interface I

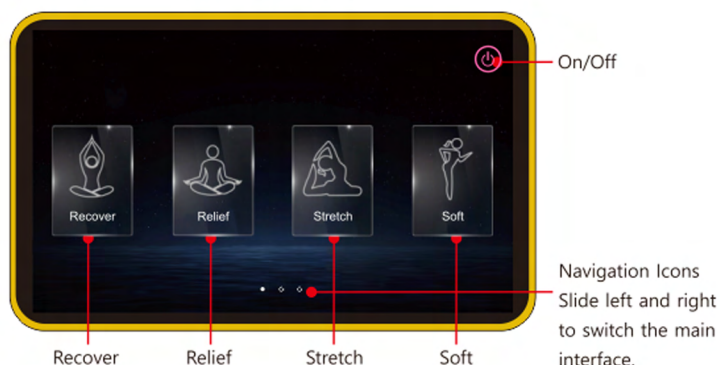

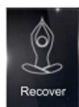

In the ON status, press this icon to enter Demo mode, default working time for this auto program is 8 minutes.

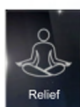

In the ON status, press this icon to enter health mode, default working time for this auto program is 20 minutes.



In the ON status, press this icon to enter stretch mode, default working time for this auto program is 20 minutes.



In the ON status, press this icon to enter the pain relief mode, default working time for this auto program is 20 minutes.

Main Interface I

Recover, Relief, Stretch and Soft interface

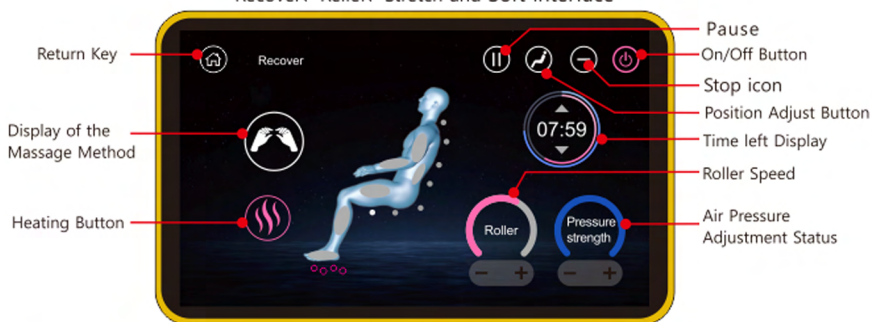

"Return" Press this button, return to the home page.



Press Power button, it turned to Pink color and massage function can be used normally



Stop icon, press this icon, the massage will stop, and remote screw back to main interface.



Press Pause button, massage function stopped, and change to this button press this button again, massage function re-start



"Knock" message method status display.



"Knead" message method display.



"Tap" message method status display.



"Shiatsu" message method display.



"Heating" is off by default. press this button to turn on Heating function.



Massage time left and adjust button, shows the time left for the current massage function, Up and down arrow key can add or reduce the time.



Roller speed adjustment, has fast and slow two levels.



Adjust air pressure strength by this button with 4 levels.



Position adjustment button, click and enter the position adjustment interface.



Body massage position, (screen can show the air massage, roller massage, heating status)

Position adjust interface

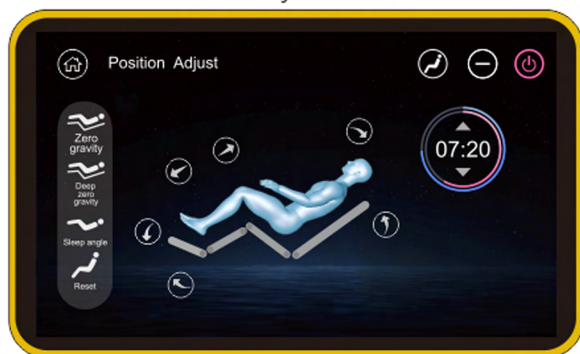

Zero gravity icon, click it to light to enter into the zero gravity function, the back will lie down, and the legrest will rise up.



Deep zero gravity icon, click it to light to enter into the deep zero gravity angle, the backrest lie down, and the legrest rise up.



Sleep angle icon, click it to light to enter into the sleep angle, the backrest lie down, and legrest rise up



"Press "Rest" button, it tured lighter,function started, back part rising and leg &foot part recover to normal.

Legrest retract

Legrest extend

Legrest down

Legrest up



Backrest downward and legrest upward

Back rest upward and legrest downward

Main interface II

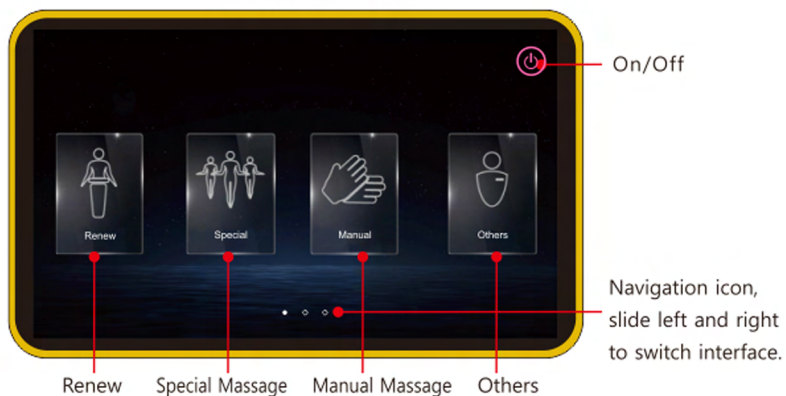

In the ON status, click it the icon lights up, enter into the relax massage mode, the default working time is 20 minutes.

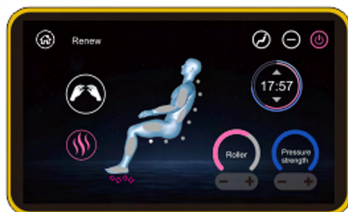

Renew Interface

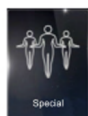

In the ON status, press this key to enter Special Massage, 7 special auto programs for your option. (See Special interface introduction

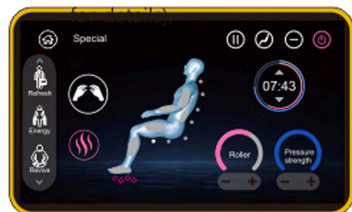

Special Massage Interface

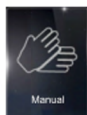

In the ON status, press this key to enter Manual program interface. (See Manual interface introduction for details).

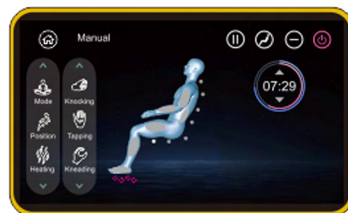

Manual Massage Interface

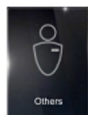

In the ON status, press this key to enter Personal Center interface. (See Personal Center interface introduction for details).



Personal Center Interface

OPERATION GUIDE

Main interface II Special Massage

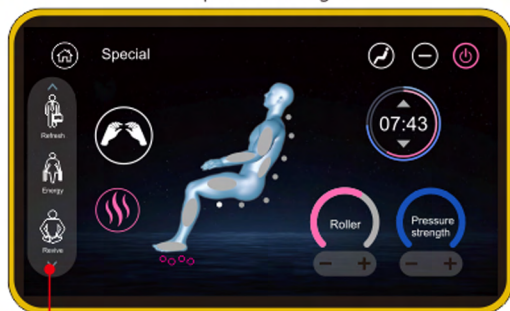

Special Massage Display Area



In the ON status, after clicking this button, the icon lights up, the "Refresh" is turned on.



In the ON status, after clicking this button, the icon lights up, the "Energy" is turned on.



In the ON status, click it the icon lights up, the "Revive" is turned on.



Music sync

In the ON status, after clicking this button, the icon lights up, the "Music Sync" is turned on.



Active

In the ON status, after clicking this button, the icon lights up, the "Active" is turned on.



Yoga Stretch

In the ON status, after clicking this button, the icon lights up, the "Yoga Stretch" is turned on.



Healing

In the ON status, after clicking this button, the icon lights up, the "Healing" is turned on.

Main interface II Manual Massage Interface

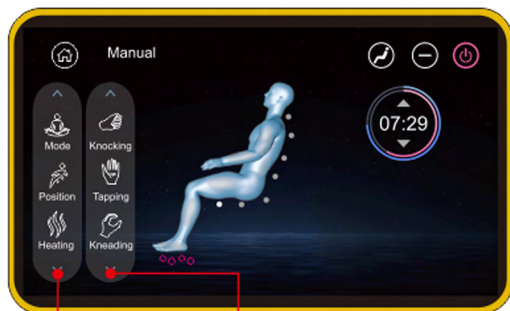

Manual Massage Mode Display Area
Display Area



Mode

In the ON status, after clicking this button, the icon lights up, one menu will pop up and display Knocking, tapping, kneading, Shiatsu, knead&tap five kinds of massage technique.

Main interface II Manual Massage Interface

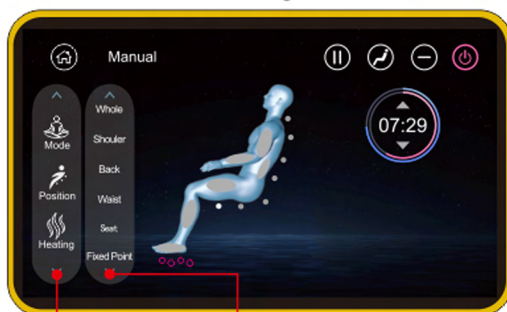

Manual Massage Display Area Mode Display Area



Position

When Power on, press this button and the menu of parts will showing: whole body, shoulder, back, waist, seat and fixed point; press "fixed point" button, it will show up and down button, you can adjust the upper and lower back massage position. Press Position again, the tablet will get back to this interface again.

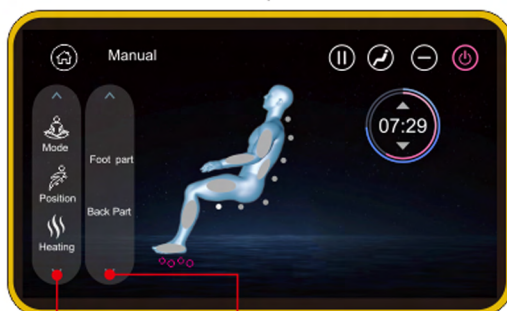

Manual Massage Display Area Mode Display Area



Heating

When power on, press this button and it will appear the menu showing "Foot parts" and "Back Part". Press the button of each part to turn on/off the heating function.

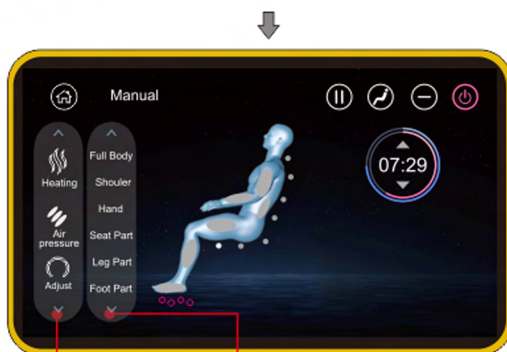

Manual Massage Display Area Mode Display Area



Air pressure

When power on, press this button and it will appear the menu showing Full body, Shoulder, Hand, Seat Part, Leg Part, Foot Part button, press one of these buttons, the air pressure massage will be started.

Main interface II Manual Massage Interface



Manual Massage Display Area
4D Adjustment
Adjustment Display Area
Air Pressure Adjustment
Roller Speed Adjustment



Adjust

In the ON status, click the icon lights up, finger touch slide from left to right, to adjust the "speed" "4D width", time, 4D, pressure strength, roller speed. 4D has 4 level, width 3 level, roller speed 2 level. Click the " " + - to adjust.

Main Interface II Personal Center Interface



Personal Center Display Area
Mode Display Area ↓



Language

When power on, press this button, it will show three languages: Japanese, Korean, Vitnamese and English.

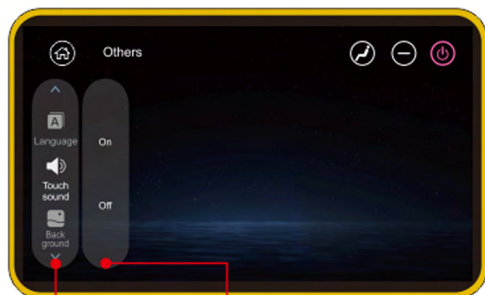

Personal Center Display Area
Mode Display Area



Touch sound

In the ON status, click this icon to light up, to open or close the touch sound.

Main Interface II Personal Center Interface

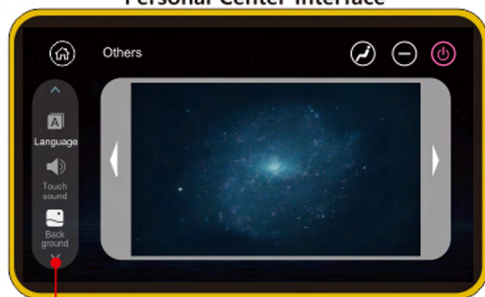

Personal Center
Display Area



When power on, press this button, it will show background interface, you can choose background accordingly.

Body Scanning

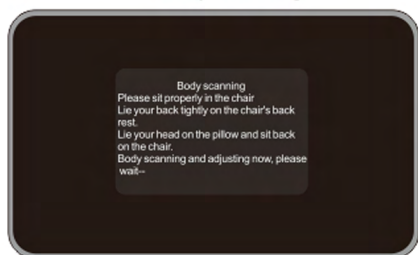

After Body Scanning ,it will show this interface

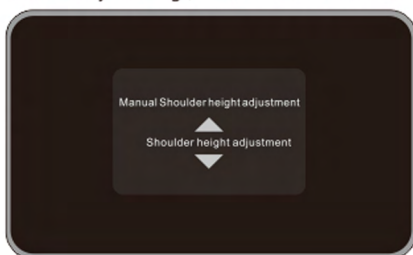

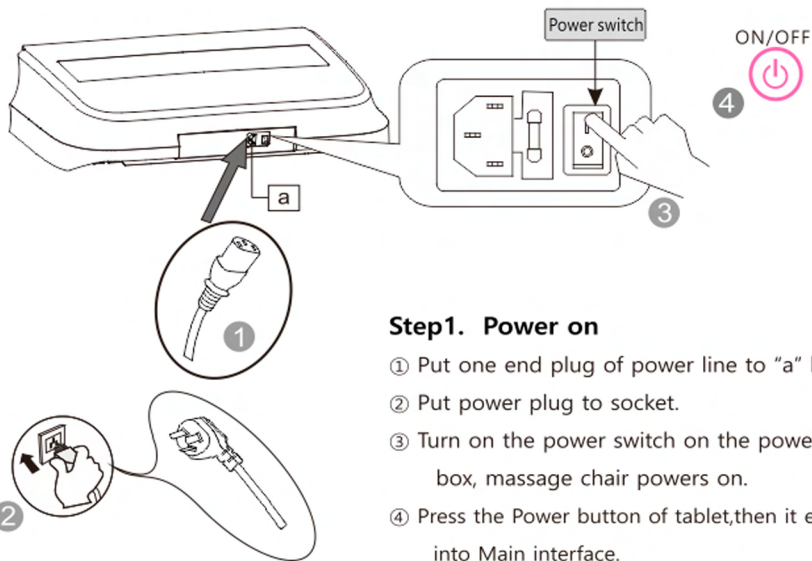

Step1. Power on

- ① Put one end plug of power line to "a" hole.
- ② Put power plug to socket.
- ③ Turn on the power switch on the power box, massage chair powers on.
- ④ Press the Power button of tablet, then it enter into Main interface.

Step2. Massage

- ① Please operate according to above Tablet Using Method and choose the suitable function.
- ② When massage finished, the chair recover to normal status, and the tablet control's Power button become to white color.



Tablet Control

On/Off

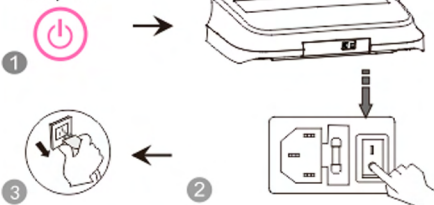

Step3. Turn off the power

- ① When the chair is On, Tablet Control press On/Off button to turn off the massage chair and it will restore automatically.
- ② Turn off the power switch on the bottom of the back of chair after the rollers reach storage position.
- ③ Unplug the power plug from the socket.

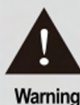

Warning

1. Before using, pull up the pillow, back cushion etc. to check if the PU material is broken, if there is damage, please stop using, unplug the chair, and ask for repairment.
2. Only plug to proper socket.



Attention

1. Before sitting down, make sure there is no things pinched between armrest, legrest, backrest and seat of the chair.
2. Foot-rest is equipped with safety protection device, if there is any obstacle between the leg and foot, foot-rest will stop retraction automatically.
3. Make sure the chair is in reset state before using.
4. Do not stand on it when using the massage chair.

Annular functional area |

● Legrest Up

Press this button on controller, legrest goes up. Release the button, legrest stops moving, the angle is locked in this position.



● Legrest Down

Press this button on controller, legrest goes down. Release the button, legrest stops moving, the angle is locked in this position.



● Legrest up and backrest down

Press this button on controller, backrest goes down and legrest goes up. Release this button, backrest and legrest stops moving, the angle is locked in this position.



● Backrest up and Legrest down

Press this button on controller, backrest goes up and legrest goes down. Release this button, backrest and legrest stops moving, the angle is locked in this position.



● Zero gravity

Press the "Zero Gravity" button on the remote control, the backrest will fall, the legrest will rise, and adjust the angle to achieve a comfortable zero gravity. It can effectively relieve the pressure on the spine and joints. Press this button again, the backrest will rise, the legrest will fall, and the angle will return to the power-on state.



★ Tips: Zero-gravity

is according to the NASA Space capsule relax theory, through the back ,seat, legrest three sections multi angle changeable,

making the legrest up and seat down can make the angle 128 (+/-7)degrees between Body and legrest..let the heart and knee at the same level, reducing the blood circulation pressure to the lowest,but all the body pressure will put on the buttocks,And because of the ZERO GRAVITY position design,increase the forced area from the body and massage chair,so all the forces can be dispersed to the massage chair, reducing heart and spine pressure ,realizing the best Zero gravity massage experience. creating a completely relax,matural and comfortable massage posture.

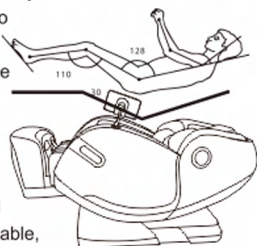

CAUTION

1. Please make sure there is no people, no pets or any stuff around the backrest to avoid unexpected hurt or property loss.
2. When adjusting the backrest, be careful of the gap between the backrest and armrest.
3. When the legrest is moving, please do not stand on or leave from the seat, do not stop the legrest from moving in case of causing damage to the chair.
4. Please refer to control instruction for more details.

OPERATION GUIDE

- **Legrest extend and retract**
Legrest can extend and retract within 8.65inches automatically.

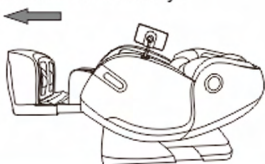

- **Arm massage**

Massage chair use space capsule type armrest, with built-in pulse air pressure massage function. Put the arms between armrest's air bags. After filling air, achieve kneading massage on the arms and hands. The arms could get comfortable massage in any angle of the chair.

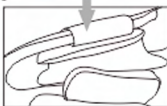

- **Shoulder massage**

Multi-layer exposed airbags are located on both shoulders to assist with stretch function. The 4D massage rollers push forward your body, while the airbags grip your shoulders to provide the ultimate full body stretch.



- **Warm foot therapy**

Innovatively developed two-way rotary foot kneading technique, realizing the sole function of kneading foot, combining with foot heating, it can perform best foot massage experience, good for health.



- **New Curve rail, Combination of back and buttocks massage.**

Massage chair adopts 4D curved rail technology, combining with 4D massage mechanism patent, realizing multi-angle integrated massage for back and buttocks. It has broken through traditional L shape rail's function which can't realize lying flat and stretching, and achieve best massage effect.



- **Music therapy**

There are multiple speakers surrounding the headrest. The blue-tooth wireless music player can integrates music into the massage techniques with synchronic therapy, which allow the rollers to massage you to the beats of your music. Relaxing to your own tunes will improve your blood and ease fatigue.

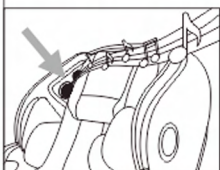

Attention!

- After using, press ON/OFF to end all the massage method and wait for restoration. Make sure to cut the electricity to avoid any unexpected hurt to children or pets.
- After using, turn off the power, unplug the electricity. Avoid moisture, dirt and aging of insulation in case of causing damage.

4.Voice control operation

*When the massage chair is open or in stand by mode, say "Activate Kahuna" or press the voice control wake-up button on the right armrest to wake up the voice control function.

*After the successful wake-up, the massage chair will reply "Ready to massage". At this time, the voice control entry corresponding to the function is realized within 6 seconds. After the massage chair is respond, the corresponding voice control function can be realized;if did not correctly say any voice entry for more than 6 seconds, the voice control function automatically turns off and needs to be reawakened.

Voice control enter		
Awakening words-"Active Kahuna" Answer – Ready to massage		
Serial No	Voice control entry	Answer entry
1	Active Kahuna	Ready to massage
2	Power OFF	Powering OFF
3	Change Position	Changing Position
4	Renew Massage	Start Renew Massage
5	Senior Massage	Start Senior Massage
6	Stretching Massage	Start Yoga Stretching
7	Heating ON	Heating ON
8	Heating OFF	Heating OFF

OPERATION GUIDE

| 3 After use |

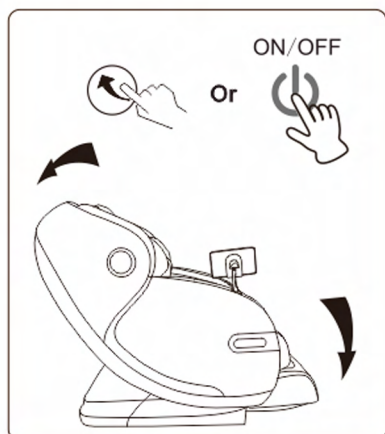

1. After the massage program is completed return the massage chair to upright position by turning off the massage chair.

Please check the surrounding prior to adjust the recline angle, paying special attention to children or pets that may be in close proximity.

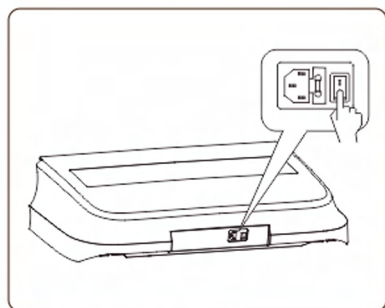

2. Press the power button to power off the massage chair and return remote controller to the storage area on arm pocket.

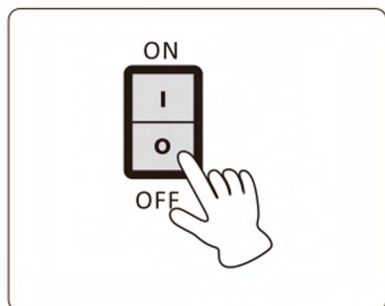

3. Turn off main power switch when you are not using the chair for a long period of time. Remove Plug from the power outlet to avoid accidents by kids and pets.

4. Do not operate with wet hands.

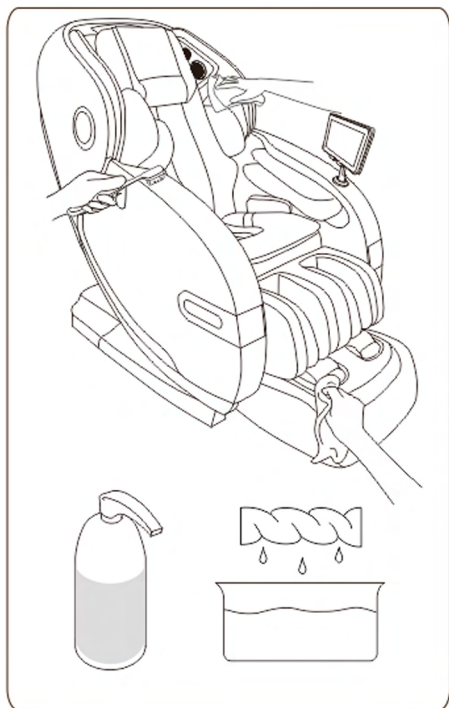

| Use dry cloth to clean |

Turn off and pull out the plug before cleaning the massage chair, do not touch the plug with wet hands.



Prohibit using liquid cleaning products like water, alcohol, or other cleaning product to maintain a good quality.

TROUBLE SHOOTING

If the sounds or movements are not normal, please turn off the massage chair and remove the plug from the electric outlet. Please contact the customer service department for further assistance.

855.646.9500, service@kahunachair.com

Problem	Solution
The massage chair is connected to power but is not functioning.	Check to see if the power plug is inserted or if the power outlet is functioning properly.
The remote controller is responding, but the massage chair is not functioning.	The massage chair may have automatically shut down due to overheating protection devices. Please turn off the power and allow the chair to cool off for 30 to 50 minutes.
Both the remote controller and massage chair are not responding.	The massage chair automatically turns into "full stop" mode when a massage program is completed. Please press the power button again to turn of the chair.



KAHUNA CHAIR PRODUCT WARRANTY REGISTRATION
<https://www.kahunachair.com/services/>

PRODUCT SPECIFICATIONS

Description	Specifications
Product Name	Kahuna Massage Chair
Model No.	SM 9300
Rated Voltage	120-240V~
Rated Frequency	50/60Hz
Rated Power Consumption	260 W
Product Dimension (LxWxH)	60 x 32 x 50 inches
Weight (LBS)	Net Weight: 338.5lbs Gross Weight :402.9lbs



Product KAHUNA Massage Chair

Model SM 9300

Distributed by AJX Distribution INC

11125 Knott Ave, Suite D

Cypress, CA 90630

Tel 1-855-646-9500

Email INFO@KAHUNACHAIR.COM

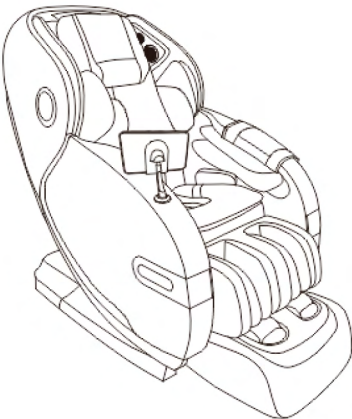

You must register warranty at www.kahunachair.com/services/

INSTRUCTION MANUAL
MODEL : SM 9300

Please read this user manual thoroughly prior to operating the massage chair. Store this booklet for future reference.