

# Operation and Maintenance Manual

Electronic Laboratory Autoclaves  
Models LABSCI 15L, LABSCI 15+L

*First time published; 04.30.2017*

---

EL-D: standard autoclave  
C: optional system for fast cooling  
PV: optional vacuum pump  
BH: optional bio hazard filtration  
F: optional fan for super-fast cooling

---

Cat. No. MAN205-0466003EN Rev N

---

 Heidolph North America , 1235 N Mittel Blvd. Suite B Wood Dale IL 60191  
☎ Phone: 224-265-9600 ☒ Fax: 224-265-9611, e-mail: [service@heidolph.com](mailto:service@heidolph.com)

---

## Table of Contents

<b>PARAGRAPH</b>	<b>PAGE NO.</b>
<b>1. General 6</b>	
<b>1.1 Introduction 6</b>	
<b>1.2 Incoming Inspection 7</b>	
<b>1.3 Warranty 8</b>	
<b>1.4 Warranty Statement 8</b>	
<b>1.5 Ordering Information 9</b>	
<b>2. Safety Instructions 10</b>	
<b>3. Technical Data 12</b>	
<b>3.1 Introduction 12</b>	
<b>3.2 Electrical Data 13</b>	
<b>3.3 Storage Conditions 14</b>	
<b>3.4 Operating Conditions 14</b>	
<b>3.5 Directives and Standards 15</b>	
<b>3.6 Water Quality 15</b>	
<b>3.7 Specifications 17</b>	
<b>3.8 Overall Dimensions 18</b>	
<b>3.9 Utilities 20</b>	
<b>3.10 Construction 21</b>	
<b>3.11 Environment Emission Information 21</b>	
<b>3.12 Safety Features 21</b>	
<b>3.13 Stickers Description 21</b>	
<b>3.14 Front View 23</b>	
<b>3.15 Rear View Models LABSCI 15L 24</b>	
<b>3.16 Rear View Model LABSCI 15+L 25</b>	
<b>3.17 Rear view for the fan configuration. 26</b>	
<b>4. Control Panel 27</b>	
<b>4.1 Control Panel Drawing 27</b>	
<b>4.2 Description and Functions of the Front Panel Keyboard 28</b>	
<b>4.3 Displayed Error Messages / Symbols 30</b>	
<b>4.4 Displayed operational messages / Symbols 30</b>	
<b>5. Sterilization Programs 32</b>	
<b>5.1 Program 1: Glass 34</b>	
<b>5.2 Program 2: Plastic 35</b>	
<b>5.3 Program 3: Liquid A 36</b>	
<b>5.4 Program 4: Liquid B – Waste 37</b>	

- 5.5 *Program 5: Liquid A – Cooling (C – cooling models only) 38*
- 5.6 *Program 6: Liquid B – Waste Cooling (C – cooling models only) 40*
- 5.7 *Program 7: Bio Hazard 1 (BH, bio-hazard models only) 41*
- 5.8 *Program 8: Bio Hazard 2 (BH, bio-hazard models only) 43*
- 5.9 *Program 9: Bio Hazard Liquids (BH, bio-hazard models only) 44*
- 5.10 *Program 10: Vacuum Test (PV, pre-vacuum models only) 45*
- 5.11 *Program 11: Warm-Up 46*
- 5.12 *Program 12: Isothermal 47*
- 5.13 *Program 13: Air Mixture 48*
- 5.14 *Program 14: Glass Test 49*
- 5.15 *Program 15: Durham 51*
- 6. *Screens 53*
  - 6.1 *Screens following a completely successful cycle – "Cycle Ended" 53*
  - 6.2 *Screens following aborted cycles after complete sterilization stage 53*
  - 6.3 *Screens following a fail cycle: 54*
- 7. *Printer 56*
  - 7.1 *Printer Output 56*
  - 7.2 *Printer Handling 59*
  - 7.3 *Filling the Water Reservoir 61*
  - 7.4 *Condense collecting tray 62*
- 8. *Installation 63*
  - 8.1 *Placing 63*
  - 8.2 *Lifting and carrying 64*
- 9. *Preparation before Sterilization 65*
  - 9.1 *Instruments 65*
  - 9.2 *Wrapped Instruments 66*
  - 9.3 *Packs 67*
  - 9.4 *Tubing 68*
  - 9.5 *Liquids 68*
- 10. *Operating Instructions 69*
  - 10.1 *Turning on the autoclave 69*
  - 10.2 *Opening the door 69*
  - 10.3 *Safety 70*
  - 10.4 *Loading 70*
  - 10.5 *Operation 70*
  - 10.6 *Closing and locking the door 71*
  - 10.7 *Starting cycle 72*
  - 10.8 *Unloading 73*
  - 10.9 *Stopping the process and cancelling the ERROR message 74*
  - 10.10 *Unloading 74*
  - 10.11 *Cycle by Clock mode 75*

---

<b>11.</b>	<b><i>Checking and Changing Parameters and Other Data</i></b>	<b>76</b>
11.1	<i>Browsing through the menus</i>	76
11.2	<i>Changing a Parameter</i>	77
11.3	<i>Quick options screen</i>	79
11.4	<i>Logging in and entering the Main menu</i>	83
11.5	<i>Changing parameters</i>	84
11.6	<i>System Parameters</i>	85
11.7	<i>Maintenance</i>	86
11.8	<i>Cycle parameters</i>	87
<b>12.</b>	<b><i>Service and Maintenance Instructions</i></b>	<b>89</b>
12.1	<i>Preventive and Scheduled Maintenance</i>	89
12.2	<i>Replacing the Air Filter</i>	91
12.3	<i>Draining the Reservoir</i>	92
12.4	<i>Cleaning water strainer</i>	93
12.5	<i>Checking the Safety Valve</i>	94
12.6	<i>Cleaning the water sensor</i>	95
12.7	<i>Moving the Autoclave</i>	96
<b>13.</b>	<b><i>Troubleshooting</i></b>	<b>97</b>
<b>14.</b>	<b><i>Baskets and Containers</i></b>	<b>102</b>
<b>15.</b>	<b><i>Spare Parts List</i></b>	<b>103</b>
<b>16.</b>	<b><i>Accessories List</i></b>	<b>103</b>
<b>1.</b>	<b><i>General</i></b> .....	<b>6</b>
1.1	<i>Introduction</i> .....	6
1.2	<i>Incoming Inspection</i> .....	7
1.3	<i>Warranty</i> .....	8
1.4	<i>Warranty Statement</i> .....	8
1.5	<i>Ordering Information</i> .....	9
<b>2.</b>	<b><i>Safety Instructions</i></b> .....	<b>10</b>
<b>3.</b>	<b><i>Technical Data</i></b> .....	<b>12</b>
3.1	<i>Introduction</i> .....	12
3.2	<i>Electrical Data</i> .....	13
3.3	<i>Storage Conditions</i> .....	14
3.4	<i>Operating Conditions</i> .....	14
3.5	<i>Directives and Standards</i> .....	15
3.6	<i>Water Quality</i> .....	15
3.7	<i>Specifications</i> .....	17
3.8	<i>Overall Dimensions</i> .....	18
3.9	<i>Utilities</i> .....	20
3.10	<i>Construction</i> .....	21
3.11	<i>Environment Emission Information</i> .....	21

---

3.12	<i>Safety Features</i> .....	21
3.13	<i>Stickers Description</i> .....	21
3.14	<i>Front View</i> .....	23
3.15	<i>Rear View Models LABSCI 15L</i> .....	24
3.16	<i>Rear View Model LABSCI 15+L</i> .....	25
3.17	<i>Rear view for the fan configuration.</i> .....	26
4.	<i>Control Panel</i> .....	27
4.1	<i>Control Panel Drawing</i> .....	27
4.2	<i>Description and Functions of the Front Panel Keyboard</i> .....	28
4.3	<i>Displayed Error Messages / Symbols</i> .....	30
4.4	<i>Displayed operational messages / Symbols</i> .....	30
5.	<i>Sterilization Programs</i> .....	32
5.1	<i>Program 1: Glass</i> .....	34
5.2	<i>Program 2: Plastic</i> .....	35
5.3	<i>Program 3: Liquid A</i> .....	36
5.4	<i>Program 4: Liquid B – Waste</i> .....	37
5.5	<i>Program 5: Liquid A – Cooling (C – cooling models only)</i> .....	38
5.6	<i>Program 6: Liquid B – Waste Cooling (C – cooling models only)</i> .....	40
5.7	<i>Program 7: Bio Hazard 1 (BH, bio-hazard models only)</i> .....	41
5.8	<i>Program 8: Bio Hazard 2 (BH, bio-hazard models only)</i> .....	43
5.9	<i>Program 9: Bio Hazard Liquids (BH, bio-hazard models only)</i> .....	44
5.10	<i>Program 10: Vacuum Test (PV, pre-vacuum models only)</i> .....	45
5.11	<i>Program 11: Warm-Up</i> .....	46
5.12	<i>Program 12: Isothermal</i> .....	47
5.13	<i>Program 13: Air Mixture</i> .....	48
5.14	<i>Program 14: Glass Test</i> .....	49
5.15	<i>Program 15: Durham</i> .....	51
6.	<i>Screens</i> .....	53
6.1	<i>Screens following a completely successful cycle – "Cycle Ended"</i> .....	53
6.2	<i>Screens following aborted cycles after complete sterilization stage</i> .....	53
6.3	<i>Screens following a fail cycle:</i> .....	54
7.	<i>Printer</i> .....	56
7.1	<i>Printer Output</i> .....	56
7.2	<i>Printer Handling</i> .....	59
7.3	<i>Filling the Water Reservoir</i> .....	61
7.4	<i>Condense collecting tray</i> .....	62
8.	<i>Installation</i> .....	63
8.1	<i>Placing</i> .....	63
8.2	<i>Lifting and carrying</i> .....	64
9.	<i>Preparation before Sterilization</i> .....	65
9.1	<i>Instruments</i> .....	65

---

9.2	<i>Wrapped Instruments</i> .....	66
9.3	<i>Packs</i> .....	67
9.4	<i>Tubing</i> .....	68
9.5	<i>Liquids</i> .....	68
10.	<i>Operating Instructions</i> .....	69
10.1	<i>Turning on the autoclave</i> .....	69
10.2	<i>Opening the door</i> .....	69
10.3	<i>Safety</i> .....	70
10.4	<i>Loading</i> .....	70
10.5	<i>Operation</i> .....	70
10.6	<i>Closing and locking the door</i> .....	71
10.7	<i>Starting cycle</i> .....	72
10.8	<i>Unloading</i> .....	73
10.9	<i>Stopping the process and cancelling the ERROR message</i> .....	74
10.10	<i>Unloading</i> .....	74
10.11	<i>Cycle by Clock mode</i> .....	75
11.	<i>Checking and Changing Parameters and Other Data</i> .....	76
11.1	<i>Browsing through the menus</i> .....	76
11.2	<i>Changing a Parameter</i> .....	77
11.3	<i>Quick options screen</i> .....	79
11.4	<i>Logging in and entering the Main menu</i> .....	83
11.5	<i>Changing parameters</i> .....	84
11.6	<i>System Parameters</i> .....	85
11.7	<i>Maintenance</i> .....	86
11.8	<i>Cycle parameters</i> .....	87
12.	<i>Service and Maintenance Instructions</i> .....	89
12.1	<i>Preventive and Scheduled Maintenance</i> .....	89
12.2	<i>Replacing the Air Filter</i> .....	91
12.3	<i>Draining the Reservoir</i> .....	92
12.4	<i>Cleaning water strainer</i> .....	93
12.5	<i>Checking the Safety Valve</i> .....	94
12.6	<i>Cleaning the water sensor</i> .....	95
12.7	<i>Moving the Autoclave</i> .....	96
13.	<i>Troubleshooting</i> .....	97
14.	<i>Baskets and Containers</i> .....	102
15.	<i>Spare Parts List</i> .....	103
16.	<i>Accessories List</i> .....	103

# 1. General

---

## 1.1 Introduction

Model LABSCI 15+L is a laboratory sterilizer designed especially for the sterilization of instruments, liquids, and other materials in hospital laboratories, laboratories & research institutes, food laboratories and pharmaceutical facilities.

The PV (pre-vacuum) models are equipped with a vacuum pump.

The advantages of the pre-vacuum sterilizer in comparison to the regular gravity displacement steam sterilizer are as follows:

- Removal of air pockets from packs and porous loads and most kinds of tubes (rubber, plastic etc.) by vacuum at the first stage of the cycle.
- Better steam penetration into the load; resulting in effective sterilization.
- Better temperature uniformity.
- Better drying of materials with closed doors due to the vacuum achieved in the chamber at the end of the sterilization cycle.

In BH (bio-hazard) models, a bio-hazard filter installed in the chamber enables sterilizing bio-hazard load without contaminating the surrounding.

There is a configuration equipped with fan that allows shortening the cooling operation.

The temperature and pressure are controlled through sensors placed inside and outside the media container or bottles.

A special feature of the autoclave is fast cooling stage for liquids. In this stage pressure in the chamber is increased by means of compressed air to compensate the fast decreasing of pressure due to the fast cooling. The fast cooling shortens the time required for safe handling of bottles.

In BH (bio-hazard) models, a bio-hazard filter installed in the chamber enables sterilizing bio-hazard load without contaminating the surrounding.

A computerized control unit ensuring a fully automatic sterilization cycle controls the autoclave.

The temperature and pressure are controlled through sensors placed inside and outside the media container or bottles.

The sterilizer is fully automatic with a choice of 15 programs, eliminating any need for operator intervention during a cycle (programs 9-10 are for vacuum testing only). A computerized control unit enables precise control and monitoring of physical parameters and clear documentation of the sterilization cycles.

The autoclave is equipped with a safety valve, which will discharge at an overpressure of over 2.8 Bar (40 psi), which is located on the chamber near the pressure switch and the steam pressure gauge. The control system provides adequate protection, to ensure the safety of personnel and reliable operation with a minimum of down time.

The sterilizer has multiple built - in safety devices, which provides adequate protection to ensure the safety of operating personnel.

The printer prints the preset and actual parameters of the cycle (temperature, time and pressure).

The autoclave is provided with a pressure gauge that is used as guide only. Should there be a power failure during the operation of the autoclave, the pressure gauge indicates to the operator that there is pressure in the chamber.

A deviation of +1.6% is accepted.

**Note:** After operating the sterilizer, brown stains might appear on the bottom of the chamber. These stains are a result of the heating elements that are located at the lower external part of the chamber. The brown color is a common phenomenon, can easily be removed, and will not have any effect on the sterilized goods.

This manual is intended to give the user a general understanding of how the autoclave works and indicates the best ways to operate and take care of it in order to obtain optimum results and a trouble-free operation. After reading this manual, operating the autoclave should be straightforward. However, since the autoclave is built using high technology sensitive components, no attempt should be made by the user or any other unauthorized person to repair or recalibrate it.



**Caution!**

**Only technical personnel having proper qualifications, holding technical documentation and adequate test instrumentation are authorized to undertake repair or service.**

## **1.2 Incoming Inspection**

The autoclave should be unpacked and inspected for mechanical damage upon receipt. Observe packing method and retain packing materials until the unit has been inspected. Mechanical inspection involves checking for signs of physical damage such as: scratched panel surfaces, broken knobs, etc.

If damage is apparent, contact your dealer or point of purchase, so that they may notify the manufacturer and file a claim with the appropriate carrier.



All **Tuttnauer** products are carefully inspected prior to shipment and all reasonable precautions are taken in preparing them for shipment to assure safe arrival at their destination.

### **1.3 Warranty**

We certify that this instrument is guaranteed to be free from defects in material and workmanship for one year against faulty components and assembly with the exception of glassware, lamps and heaters.

**The warranty does not include and does not replace routine treatment and preventive maintenance to be performed according to instructions in sec. 12.1 (Preventive Maintenance).**

Our obligation is limited to replacing the instrument or parts, after our examination, if within one year after the date of shipment they prove to be defective. This warranty does not apply to any instrument that has been subjected to misuse, neglect, accident or improper installation or application, nor shall it extend to products that have been repaired or altered outside the factory without prior authorization from us.

**The Autoclave should not be used in a manner not described in this manual!**

### **1.4 Warranty Statement**

To activate your warranty or for warranty information on this unit please contact your dealer or Heidolph at one of the #'s listed below:

☒ Heidolph North America, 1235 Mittel Blvd. Suite B Wood Dale IL 60191

#### **Service & Repair Division**

Troubleshooting, Service incidents, Warranty repair, Repair, Services and Return authorization

☎ Phone: 224-265-9600 ☒ Fax: 224-265-9611, e-mail: [service@heidolph.com](mailto:service@heidolph.com)

**Tuttnauer USA Co., Ltd.**, 25 Power Drive Hauppauge, NY 11788, USA  
(800) 624 5836, (631) 737 4850, Fax: (631) 737 0720  
e-mail: [info@tuttnauerUSA.com](mailto:info@tuttnauerUSA.com).

#### **Note:**

If you have any questions or there are any difficulties with this instrument and the solution is not covered in this manual, please contact your dealer or Heidolph.

---

**Do not attempt to service this instrument yourself.**

If there is any difficulty with this instrument, and the solution is not covered in this manual, contact our representative or us first. Do not attempt to service this instrument yourself. Describe the difficulty as clearly as possible so we may be able to diagnose the problem and provide a prompt solution.

If the autoclave is equipped with a printer, send along a copy of the last printout for our inspection. If replacement parts are needed, stipulate the model and serial number of the machine.

No products will be accepted for repair without proper authorization from us. All transportation charges must be paid both ways by the owner. This warranty will be void if the unit is not purchased from an authorized full service **Tuttnauer** dealer.

## **1.5 Ordering Information**

Several items must be specified when ordering the unit from your dealer.

- The chamber diameter and chamber depth required
- Please specify the supply voltage available (i.e. 115v/208v; 1Ph/3Ph)
- The temperature scale needed (Celsius or Fahrenheit).

The pressure scale needed (kPa or psi)

## 2. Safety Instructions

---

The autoclave has unique characteristics. Please read and understand the operation instructions before first operation of the autoclave. The following issues may require instructions guidance provided by the manufacturer: how to operate the autoclave, the door safety mechanism, the dangers involved in circumventing safety means, how to ensure that the door is closed, and how to select a correct sterilization program.

1. Make sure that you know where the main power switch is, where the water cut-off valve is and where the steam and compressed air disconnection valves are located.
2. Autoclave maintenance is crucial for the correct and efficient function of the device. We enclose a log booklet that includes maintenance recommendations, with every device.
3. The weekly spore test is part of the preventive maintenance plan, along with the annual validation of the sterilization processes that ensures appropriate temperature dispersion within the chamber.
4. Never use the autoclave to sterilize corrosive products, such as: acids, bases and phenols, volatile compounds or solutions such ethanol, methanol or chloroform nor radioactive substances.
5. Never start using a new autoclave or a new steam generator, before the safety, licensing and authorization department has approved it for use.
6. All autoclave users must receive training in proper usage from an experienced employee. Every new employee must undergo a training period under an experienced employee.
7. A written procedure must be established for autoclave operation, including: daily safety tests, seal inspection and door hinge inspection, smooth action of the closing mechanism, chamber cleaning, prevention of clogging and preservation from corrosion, what is permitted and what is prohibited for sterilization and choosing a sterilization program.
8. Liquids may be sterilized only with the "liquids" program. The container must be covered but not sealed. Sealed bottles may only be sterilized using a special program. The bottle must be either Pyrex or a Borosilicate glass bottle.
9. When sterilizing plastic materials, make sure that the item can withstand sterilization temperature. Plastic that melts in the chamber is liable to cause a great deal of damage.
10. Individual glass bottles may be placed within an appropriate container that will be placed on a tray. Never place glass bottles on the floor of the autoclave. Never fill more than 2/3 of the bottle volume.
11. On closing the autoclave's door, make sure it is properly locked before activating.

12. Before withdrawing trays, wear heat resistant gloves.
13. Before opening the door, verify that there is no pressure in the chamber (chamber pressure gauge is located on the autoclave's front panel).
14. Open the door slowly to allow steam to escape and wait 5 minutes before you remove the load. When sterilizing liquids, wait 10 minutes.
15. Once a month, ensure that the safety valves are functioning, and once annually a certified tester must conduct pressure chamber safety tests.
16. Once annually, or more frequently, effective tests must be performed, i.e., calibration and validation.
17. Examine the condition of assemblies on a regular basis. Make sure there are no leaks, breaks, blockages, whistles or strange noises.
18. It is required to conduct maintenance operations as instructed.
19. Immediately notify the person in charge of any deviation or risk for the proper function of the device.

## 3. Technical Data

---

### 3.1 Introduction

Models LABSCI 15L and LABSCI 15+L are table-top sterilizers designed especially for sterilization of instruments, liquids medical waste, and other materials in hospital laboratories, laboratories & research institutes, food laboratories and pharmaceutical facilities.

A computerized control unit ensuring a fully automatic sterilization cycle controls the autoclave.

The temperature and pressure are controlled through sensors placed inside and outside the media container or bottles.

Special feature of ELCPV-D model is the vacuum pump that enables air removal prior to sterilization and during the drying stage.

The advantages of the pre-vacuum sterilizer in comparison to the regular gravity displacement steam sterilizer are as follows:

- Removal of air pockets from packs and porous loads and most kinds of tubes (rubber, plastic etc.) by vacuum at the first stage of the cycle.
- Better steam penetration into the load; resulting in effective sterilization.
- Better temperature uniformity.
- Better drying of materials with closed doors due to the vacuum achieved in the chamber at the end of the sterilization cycle.

The sterilizer is equipped with a fan on the door to shorten the cooling operation.

There is a configuration equipped with fan that allows to shorten the cooling operation.

The sterilizer is fully automatic with a choice of seven programs (including vacuum test program), eliminating any need for operator intervention during a cycle. The custom programs are programs that may be changed by an authorized person. A computerized control unit enables precise control and monitoring of physical parameters and clear documentation of the sterilization cycles.

The autoclave is equipped with a safety valve, which blows off at 280 kPa (40 psi) (max. working pressure). The safety valve is located in the mineral free water reservoir. The control system provides adequate protection, to ensure the safety of personnel and reliable operation with a minimum of down time.

On all models, a printer is an optional addition to the autoclave. The printer prints the preset and actual parameters of the cycle (temperature, time and pressure/vacuum).

The autoclave is provided with a pressure gauge that is used as guide only. Should there be a power failure during the operation of the autoclave, the pressure gauge indicates to the operator that there is pressure in the chamber.

A deviation of +1.6% is accepted.

After operating the sterilizer, brown stains might appear on the bottom of the chamber. These stains are a result of the heating elements that are located at the lower external part of the chamber. The brown color is a common phenomenon, can easily be removed, and will not have any effect on the sterilized goods.

This manual is intended to give the user a general understanding of how the autoclave works and indicates best ways to operate and maintain it in order to obtain optimum results and a trouble free operation.

After reading this manual, operating the autoclave should be straight forward. However, since the autoclave is built using high technology sensitive components, no attempt should be made by the user or any other unauthorized person to repair or re-calibrate it.



**Caution!**

**Only technical personnel having proper qualifications, holding technical documentation and adequate test instrumentation, are authorized to undertake repair or service.**

### 3.2 Electrical Data

#### 230V configuration

Property	Value: LABSCI 15	Value: LABSCI 15+L
Total Power	3000W (2*1500W)	4500W (3*1500W)
Voltage	1Ph, 230VAC	3Ph, 230VAC
Amperage	13A	13A
Protection against electrical shock	Class I (IEC 60601-1)	
Mains supply fluctuation	+/- 10%	
Degree of protection by enclosure	IP31	

## 400V configuration

Property	Value: LABSCI 15	Value: LABSCI 15+L
Total Power	3000W (2*1500W)	4500W (3*1500W)
Voltage	3Ph, 400VAC	3Ph, 400VAC
Amperage	13A	13A
Protection against electrical shock	Class I (IEC 60601-1)	
Mains supply fluctuation	+/- 10%	
Degree of protection by enclosure	IP31	

### 3.3 Storage Conditions



#### Caution!

**Packed or unpacked, the autoclave shall be retained in indoor conditions!**

### 3.4 Operating Conditions

- ◆ The autoclave is intended to work in 'indoor' conditions only.
- ◆ Only autoclavable materials shall be used.
- ◆ The environment shall not exceed an ambient temperature range of 5°C (41°F)-40°C (104°F) and a relative humidity of 85% respectively.
- ◆ The operation altitude shall not be over 2000 meters (6561 feet) (ambient pressure shall not be lower than 80 kPa (11.6 psi)).



#### Cautions!

**Waste water should be brought into the public net in accordance with the local rules or requirements i.e. ONLY NON-HAZARDOUS LIQUIDS SHALL BE DISPOSED IN PUBLIC SEWAGE!**

**The autoclave shall not be used in a manner not specified in this manual! If the equipment is used in a manner not specified by the manufacturer, the protection provided by the equipment may be impaired.**

**Do not use the autoclave in the presence of dangerous gases.**

### 3.5 Directives and Standards

Every autoclave meets the provisions of the following Directives and is constructed in compliance with the following Standards:

<b>EN ISO</b>	13485:2012	(Quality Systems for Devices)
<b>ISO</b>	9001:2008	(Quality Systems)
<b>MDD</b>	93/42/EEC	(Device Directive)

Tuttnauer. Ltd. company also works in conjunction with and refers to:

<b>AAMI/ANSI-ST8</b>	Hospital sterilizers	
<b>ASME</b>	American Society of Mechanical Engineers Section VIII, Division 1, for unfired pressure vessels	
<b>EN 13060</b>	Small Steam Sterilizers	
<b>UL</b>	UL 61010-1	
<b>PED</b>	97/23EEC	
<b>IEC</b>	IEC 61010-2-040 Safety	
<b>IEC</b>	IEC 61326-1 EMC	
<b>ISO</b>	17665-1:2006 (Validation and Routine Control)	

### 3.6 Water Quality

The distilled or mineral-free water supply shall be according to the table below:

#### Physical Characteristics and Maximum acceptable contaminants levels in water or steam, for steam generator and sterilizers

	Contaminants in water supplied to generator/chamber	Contaminants in condensate at steam inlet to sterilizer
<b>Evaporate residue</b>	≤ 10 mg/l	N/A
<b>Silicate (SiO<sub>2</sub>)</b>	≤ 1 mg/l	≤ 0.1 mg/l
<b>Iron</b>	≤ 0.2mg/l	≤ 0.1mg/l
<b>Cadmium</b>	≤ 0.005 mg/l	≤ 0.005 mg/l
<b>Lead</b>	≤ 0.05 mg/l	≤ 0.05 mg/l
<b>Rest of heavy metals except iron, cadmium, lead</b>	≤ 0.1 mg/l	≤ 0.1 mg/l
<b>Chloride (Cl)</b>	≤ 2 mg/l	≤ 0.1 mg/l



<b>Phosphate (P<sub>2</sub>O<sub>5</sub>)</b>	≤ 0.5 mg/l	≤ 0.1 mg/l
<b>Conductivity (at 25°C)</b>	3 to 15 µs/cm	≤ 3 µs/cm
<b>pH value (degree of acidity)</b>	5 to 7.5	5 to 7
<b>Hardness (Σ ions of alkaline earth)</b>	≤ 0.02 mmol/l	≤ 0.02 mmol/l
<b>Appearance</b>	Colorless, clean, without sediments	

Compliance with the above data should be tested in accordance with acknowledged analytical methods, by an authorized laboratory.

**Attention:**

**The use of water for autoclaves that do not comply with the table above may have severe impact on the working life of the sterilizer and can invalidate the manufacturer's guarantee.**

**Use only deionized water, having a maximum conductivity of 15 µs/cm. Conductivity greater than 15 µs/cm may cause failures.**

**Tap water supply**

**The range of hardness value 0.7-2.0 mmol/l (70- 200 mg/l CaCO<sub>3</sub>)**

**The use of soft water is strictly forbidden!**

**Please consult a water specialist!**

**3.6.1 Drain Cooling**

The feed water supplied to the drain cooling must meet the following requirements:

- Hardness: 0.7 - 0.2 mmol/l.
- Water temperature shall not exceed 15°C (59°F).

**3.6.2 Reverse Osmosis**

A Reverse Osmosis (RO) system may be used to improve the quality of the water used to generate steam in the autoclave chamber.

In RO, the water is forced through a semi-penetrable membrane, which filters out contaminants to a high degree of efficiency. In deionisation (DI) ions and charged particles are removed either by electric fields or by ion exchange in resin beds.

Although the RO cannot normally attain the degree of purity possible with the DI methods, it is more than adequate for the feed water intended for clean-steam generators.

Moreover the RO has several advantages:

1. RO is cheaper to install and to run than DI.
2. RO removes particulate matter, organic molecules and pyrogens that DI cannot remove
3. RO water is less corrosive to steel and copper than DI water.

4. RO maintenance requirements are less demanding than those of the DI units.  
Therefore the use of mineral free water will contribute to better performance and longer life of the autoclave.

### 3.7 Specifications

Model		LABSCI 15L	LABSCI 15+L
Property			
Overall dimensions	Height	540mm	540mm
	Width	720mm	720mm
	Length	765mm	765mm
Maximum dimensions (door open)	Width	805mm	800mm
	length	1260mm	1430mm
Distance between supporting legs	Width	620mm (rear legs), 480mm (front legs)	620mm (rear legs), 480mm (front legs)
	Length	540mm	720mm
Weight per support area (max. load)		According to overall weight and floor loading requirements	
Net weight		98kg	98kg
Shipping volume		0.76	0.76
Shipping weight		120 kg	120 kg
Shipping dimensions	length	1150mm	1150mm
	width	850mm	850mm
	height	780mm	780mm
Max. Allowable Working pressure (MAWP)		2.8 bar	2.8 bar
Chamber	diameter	380mm	380mm
	Depth	490mm	690mm
Chamber Volume		65L	85L

### 3.8 Overall Dimensions

#### Model LABSCI 15L

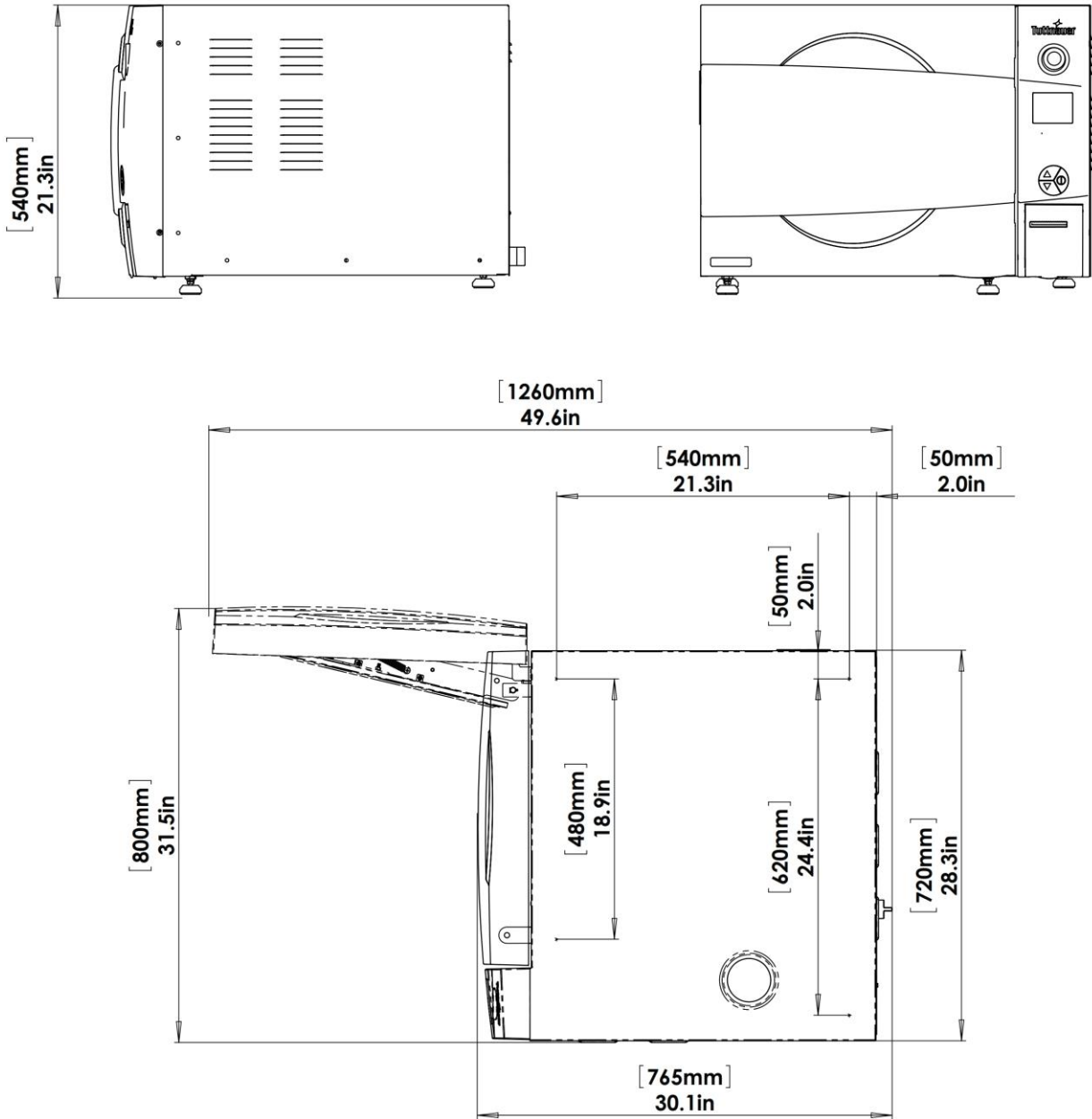

**Models LABSCI 15+L**

Fan motor (3870 ELPRC only, other models have it inside)

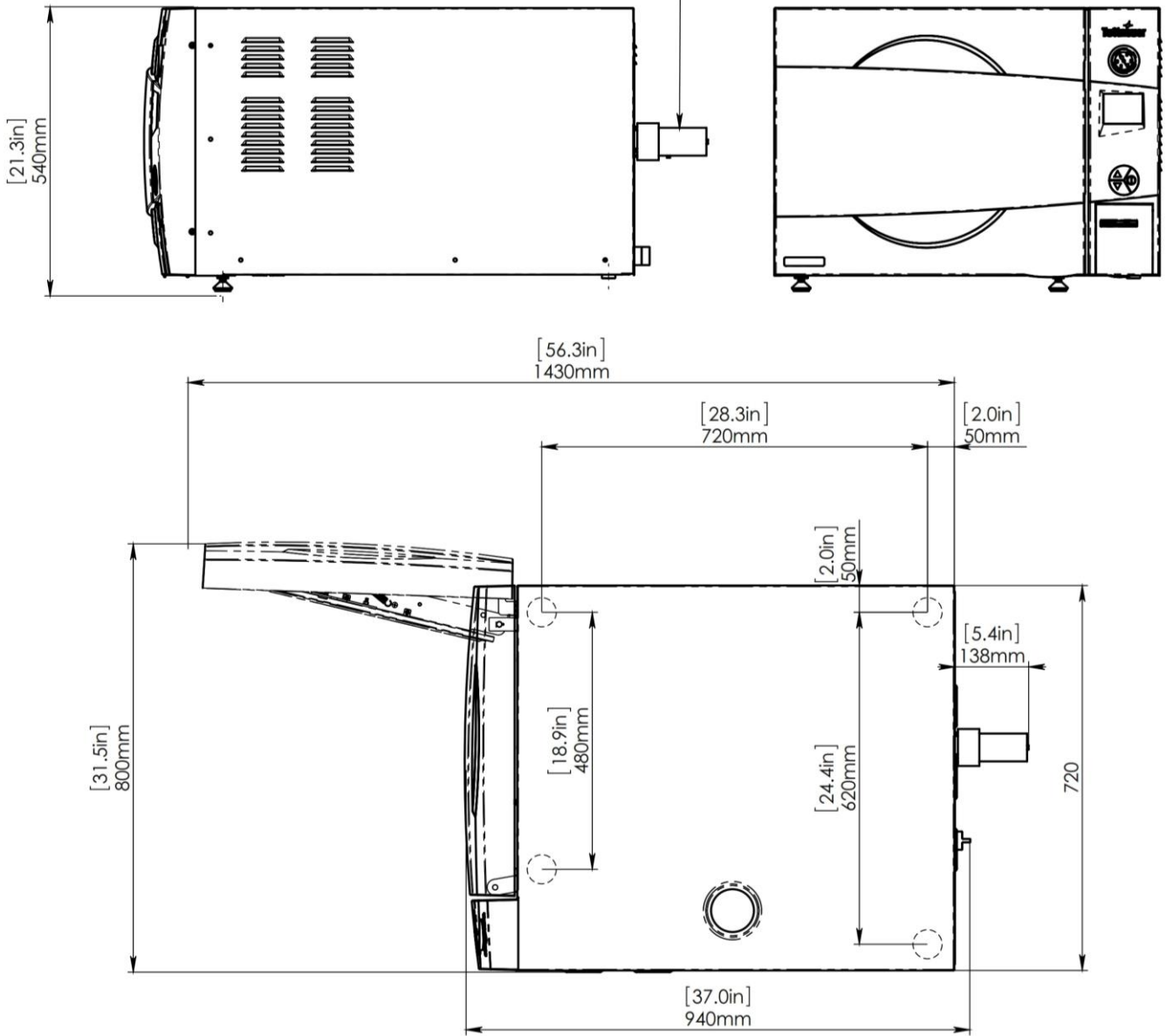

## 3.9 Utilities

### 3.9.1 Electrical utility

Property	Value: LABSCI 15L	Value: LABSCI 15+L
Power supply	208/230VAC $\pm$ 10%, 50Hz	400VAC $\pm$ 10%, 50Hz
Recommended circuit breaker	15A	10A

### 3.9.2 Other Utilities

<b>Compressed Air (C models only)</b>	1/2" 3 Bar (44-58 psi)
<b>Tap water</b>	1/2", 2-6 Bar (29-44 psi)
<b>Mineral free water</b>	1/2", 2-3 Bar (29-44 psi)
<b>Drain</b>	2" Minimum Withstanding temp. of 80°C (176°F)



#### Attention:

- A switch or circuit-breaker must be included in the building installation. This switch or circuit-breaker shall be in close proximity to the equipment, within easy reach of the operator; and marked as the disconnecting device for the equipment.
- The electrical net must be protected with a current leakage safety relay.
- The electrical network must comply with local rules or regulations.
- Verify that there is an easy access to the main power switch, to the water cut-off valve and to the current leakage safety relay.
- Make sure while placing the autoclave, to leave space around the machine, to give the technician access to service the machine.
- All water connections to autoclave must be performed through "BACK FLOW PREVENTION SYSTEM" only, as per IEC 61770.

### 3.10 Construction

The main parts of the autoclave are made of materials as indicated below:

- Chamber and door are made of stainless steel
- Trays are made of stainless steel.
- Water reservoir is made of hard plastic material.
- Door handle is made of hard plastic material, which is safe to touch and thermo-insulated.

### 3.11 Environment Emission Information



- The peak sound level generated by the autoclave is less than 70 dBA with background noise of 60 dBA.
- The total heat per hour transmitted by the autoclave 3840, 3850 models is < 300 W/h, and for 3870 model is < 450Wh.





### 3.12 Safety Features

This autoclave includes built-in safety features such as:

- Error message display.
- Temperature dependent door locking system according to European standards.
- Electronic pressure and temperature measurement.
- Safety relief valve to avoid build-up of excessive pressure.
- Door switch enabling operation to be started only when the door is closed.
- Water level safety device.
- Excess temperature protection.

### 3.13 Stickers Description

Symbol	Meaning	Part Number	Location
	Caution! Hot steam.	LAB048-0058	Near the safety valve
	Protective earth (Ground)	LAB048-0020	Near the earthing screw

	<p>Caution! Hot surface.</p>	<p>LAB048-0023</p>	<p>On the rear cover above the water strainer</p>
	<p>Press &amp; Hold Until "System Ready" is Displayed = 10 sec.</p>	<p>LAB048-0461 (Automatic door only)</p>	<p>On the door right edge</p>
	<p>Don't Touch Microswitches please Contact Tuttnauer Service</p>	<p>LAB048-0462</p>	<p>On the door frame behind the door cover</p>
	<p>Don't Touch Microswitches please Contact Tuttnauer Service</p>	<p>LAB048-0463</p>	<p>On the door frame behind the door cover</p>
<div style="border: 1px solid black; padding: 5px; width: 100px;"> <p style="text-align: center;"><b>ON</b></p>     <p style="text-align: center;"><b>OFF</b></p> </div>	<p>On-Off</p>	<p>LAB048-0018</p>	<p>Near the Power switch</p>

### 3.14 Front View

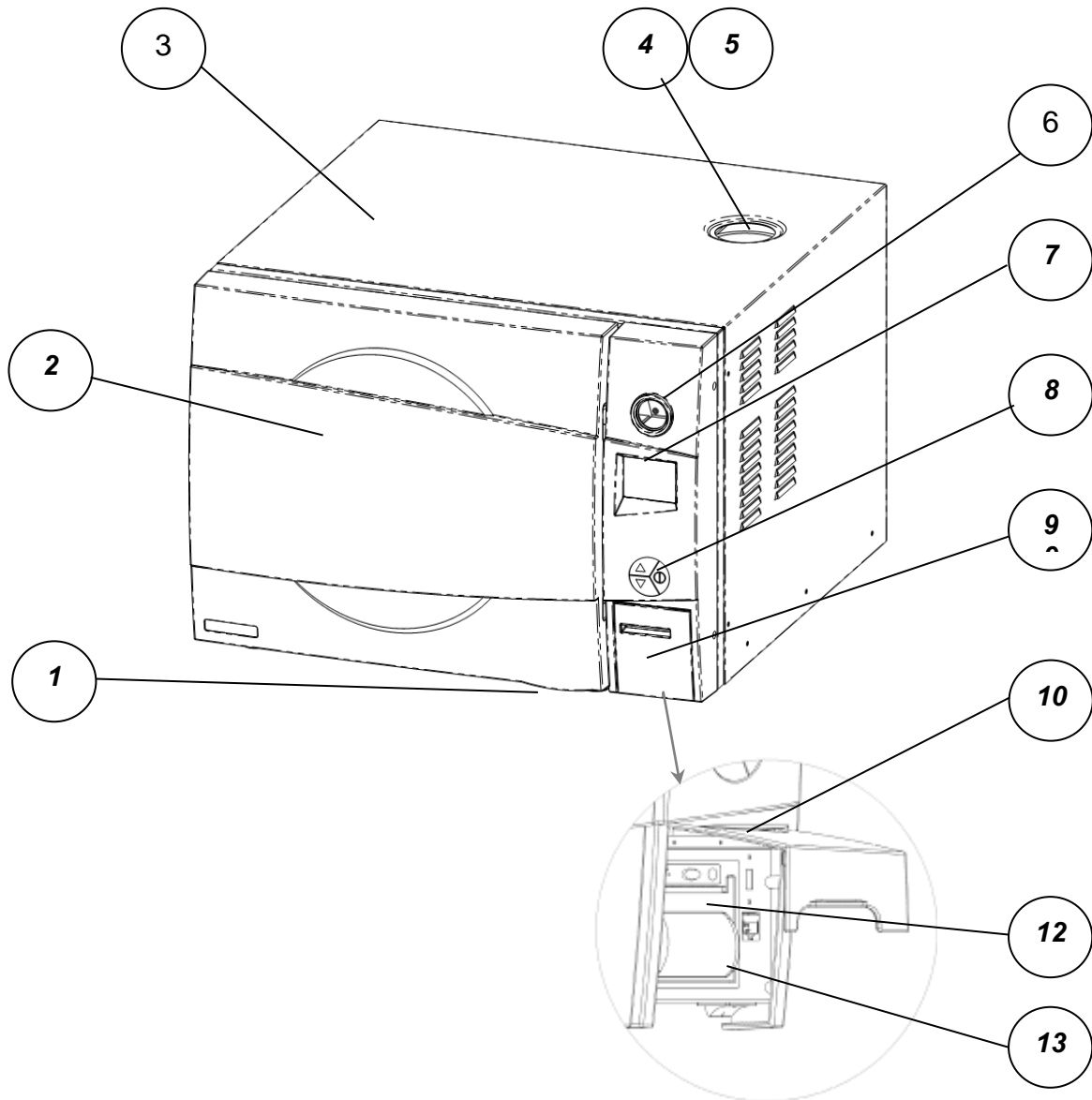

No.	Description	No.	Description
1	Door opening grip	7	Display
2	Door cover	8	Operating key board
3	Autoclave cover	9	Printer cover
4	Mineral-free water reservoir cover	10	USB connection
5	Safety valve	11	Printer (option)
6	Autoclave's pressure gauge	12	Autoclave power switch



### 3.15 Rear View Models LABSCI 15L

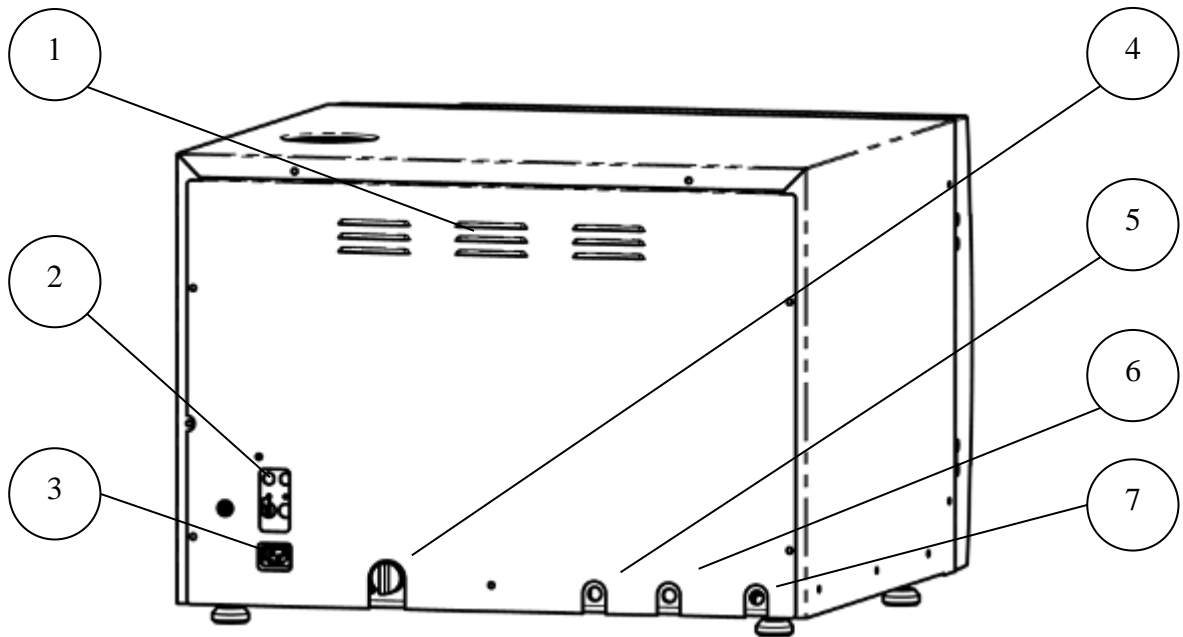

No.	Description
1	Ventilation grills
2	Circuit breaker
3	Main power electric cable socket
4	Strainer
5	Drain
6	Tap Water
7	Air Inlet

### 3.16 Rear View Model LABSCI 15+L

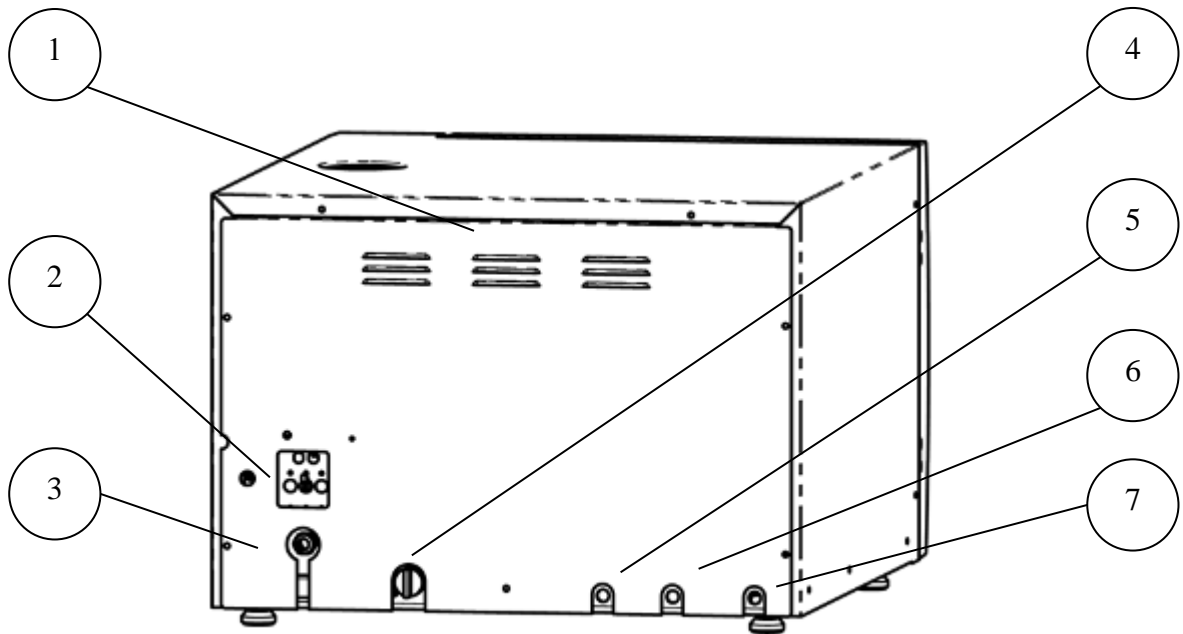

No.	Description
1	Ventilation grills
2	Circuit breaker
3	Main power electric cable socket
4	Strainer
5	Drain
6	Tap Water
7	Air Inlet

### **3.17 Rear view for the fan configuration.**

There is a configuration equipped with a fan that allows to shorten the cooling operation. The fan is located on the rear cover of the autoclave.



## 4. Control Panel

### 4.1 Control Panel Drawing

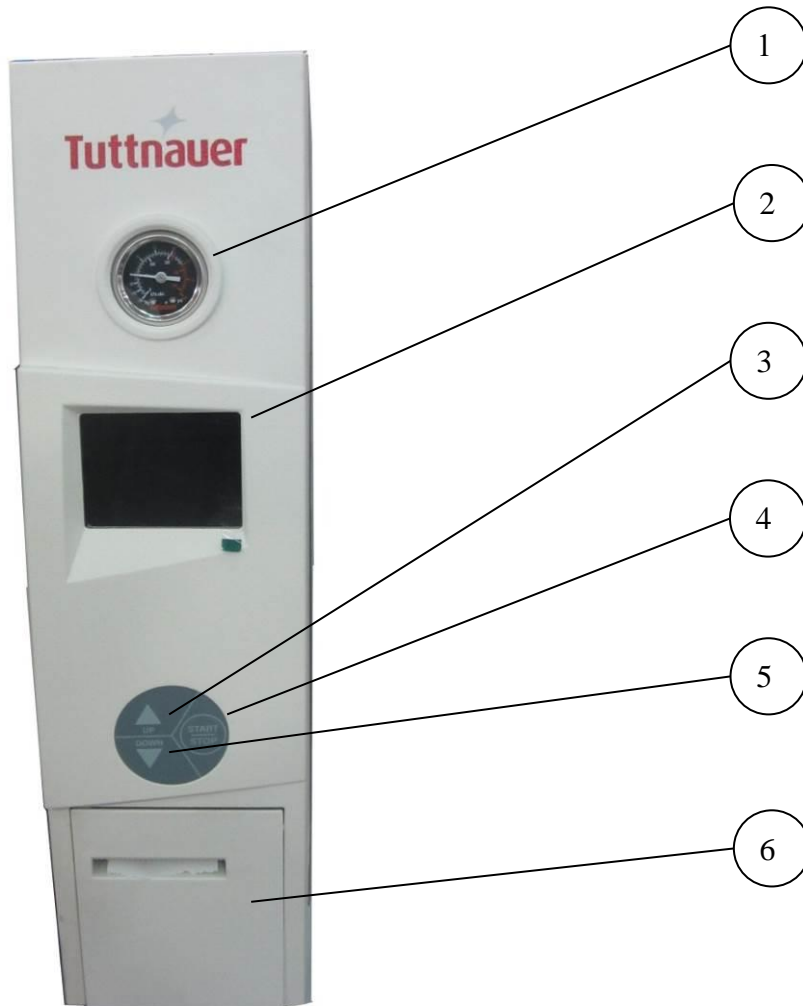

No.	Description
1	Pressure Gauge
2	Display
3	Keypad: Up Button
4	Keypad: Start/Stop Button
5	Keypad: Down Button
6	Printer

## 4.2 Description and Functions of the Front Panel Keyboard

The front panel is composed of 3 sections:

1. Display screen.
2. Keypad.
3. Printer

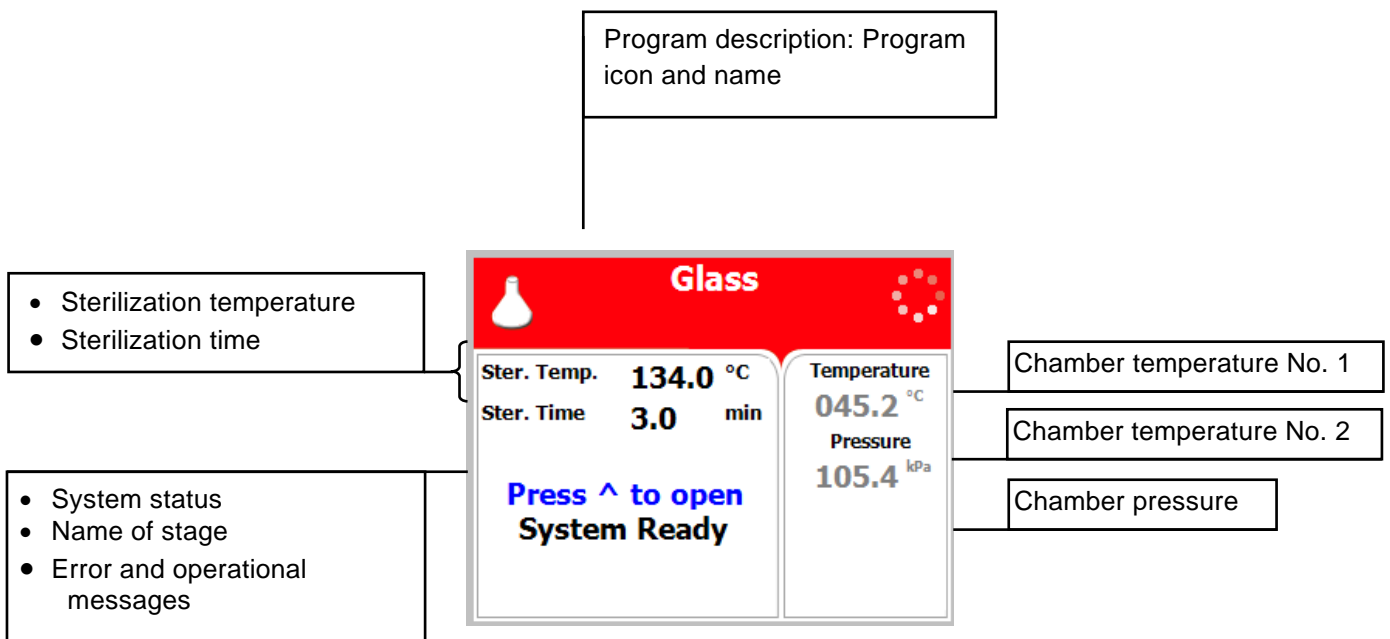

### 4.2.1 Display screen

The display is a LCD panel used to display the current status of the autoclave while using Operational Messages and Error Messages.



#### 4.2.2 Keypad

The keypad consists of three keys as described below:

<p><b>UP key</b></p> <p>This key has the following functions:</p> <ul style="list-style-type: none"> <li>• In the menu directories: <ul style="list-style-type: none"> <li>○ This key enables the operator to browse through the directories.</li> </ul> </li> <li>• In the available subdirectories: <ul style="list-style-type: none"> <li>○ When the cursor is blinking on a number, the <b>UP ▲</b> key increases its value.</li> <li>○ When adjusting a parameter and the cursor is blinking on <b>Set</b> or <b>Exit</b> the <b>UP ▲</b> key activates that procedure.</li> </ul> </li> </ul>	
<p><b>DOWN key</b></p> <p>This key has the following functions:</p> <ul style="list-style-type: none"> <li>• In the menu directories: <ul style="list-style-type: none"> <li>○ This key enables the operator to browse through the directories.</li> </ul> </li> <li>• In the available subdirectories: <ul style="list-style-type: none"> <li>○ When the cursor is blinking on a number, the <b>DOWN ▼</b> key decreases its value.</li> <li>○ When adjusting a parameter and the cursor is blinking on <b>Set</b> or <b>Exit</b> the <b>DOWN ▼</b> key activates that procedure.</li> </ul> </li> </ul>	
<p><b>START/STOP key</b></p> <p>This key has the following functions:</p> <ul style="list-style-type: none"> <li>• In the main screen: <ul style="list-style-type: none"> <li>○ Starts the process when the required program was chosen.</li> <li>○ Stops the current process.</li> <li>○ Cancels the ERROR message displayed on the screen.</li> </ul> </li> <li>• In the menu directories: <ul style="list-style-type: none"> <li>○ When the cursor is blinking on a number, the <b>START/STOP</b> key enables moving to the next position.</li> <li>○ When the cursor is blinking on a selected directory, the <b>START/STOP</b> key activates that selection.</li> </ul> </li> </ul>	

#### 4.2.3 Printer

The printer is an optional device.

It prints the detailed history of each cycle performed by the autoclave. The printing is on thermal paper with 24 characters per line and records the sterilization cycle information for subsequent consideration.



### 4.3 Displayed Error Messages / Symbols

The failures are divided into two categories.

- a. Failure that occurs before completing the sterilization stage, which in this case will leave the load unsterilized
- b. Failure that occurs after completing the sterilization stage, which in this case will leave the load sterilized

For the list of *Displayed Error Messages / Symbols* see sec. 13. **TROUBLESHOOTING**









### 4.4 Displayed operational messages / Symbols







Message / Symbol Name	Message / Symbol Description	Required Action
	This symbol is displayed when the door is open.	Close the door.
Door is open (during stand by)	This message is displayed when the door is opened: In standby - if <b>START/STOP</b> is preset.	Close the door to perform a new cycle.
Cycle Ended	This message is displayed when the cycle ended successfully.	Press <b>START/STOP</b> in order to perform a new cycle.
Test Ended	This message is displayed when the test ended.	Press <b>START/STOP</b> in order to perform a new test
	This symbol is displayed when Cycle by Clock mode is performed.	Enter the Admin menu as described in this manual to change the time or to cancel this option.
Cycle by clock	This message is displayed if the user presses <b>START/STOP</b> key while the "cycle by clock" mode is active.	Enter the Admin menu as described in this manual to change the time or to cancel this option.

<p>Atmospheric pressure not set</p>	<p>This message is displayed in order to set the atmospheric pressure by opening the door for 5 minutes.</p>	<p>Open the door for 5 minutes in order to set the Atmospheric pressure.</p>
<p>Critical settings have been updated, Please restart machine in order for changes to be updated</p>	<p>If a change of the autoclave setting was made, a restart operation is required.</p>	<p>Restart the autoclave in order for changes to be updated.</p>
	<p>This message is displayed if the electrode in the chamber senses water.</p>	<p>Perform a new cycle to drain the chamber.</p>



## 5. Sterilization Programs

Sterilization Programs			Temp.	Sterilization Time (minutes)	Drying Time (minutes)	C models only	PV models only	BH models only
Icon	No.	Description						
	1.	<b>Glass</b>	134°C (273°F)	3	1			
	2.	<b>Plastic</b>	121°C (250°F)	15	1			
	3.	<b>Liquid A</b>	121°C (250°F)	15				
	4.	<b>Liquid B – Waste*</b>	121°C (250°F)	30				
	5.	<b>Liquid A – Cooling*</b>	121°C (250°F)	15		√		
	6.	<b>Liquid B Waste Cooling*</b>	121°C (250°F)	30		√		
	7.	<b>Bio Hazard 1*</b>	134°C (273°F)	30	1			√
	8.	<b>Bio Hazard 2*</b>	121 (250°F)	45	1			√

Sterilization Programs			Temp.	Sterilization Time (minutes)	Drying Time (minutes)	C models only	PV models only	BH models only
Icon	No.	Description						
	9.	<b>Bio Hazard Liquids*</b>	121 (250°F)	45				√
	10.	<b>Vacuum test (PV only)*</b>		5 +10			√	
	11.	<b>Warm-Up*</b>	80 °C (176°F)	20				
	12.	<b>Isothermal*</b>	80 °C (176°F)	20				
	13.	<b>Air Mixture*</b>	121°C (250°F)	15				
	14.	<b>Glass Test*</b>	121°C (250°F)	20				
	15.	<b>Durham*</b>	121°C (250°F)	15				

**\*These programs are optional**

During the process, the stages of the cycle will be displayed on the screen:

The stages names are as follows:

- Start
- Pulse Low (PV models only)
- Pulse High (PV models only)
- Water Inlet
- Heating
- Sterilization
- Cooling (C models only)
- Exhaust
- Drying (PV model only)
- Ending

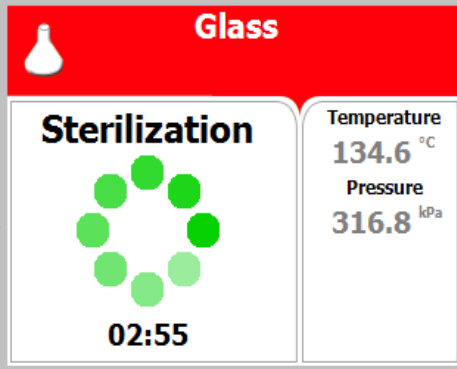

## 5.1 Program 1: Glass

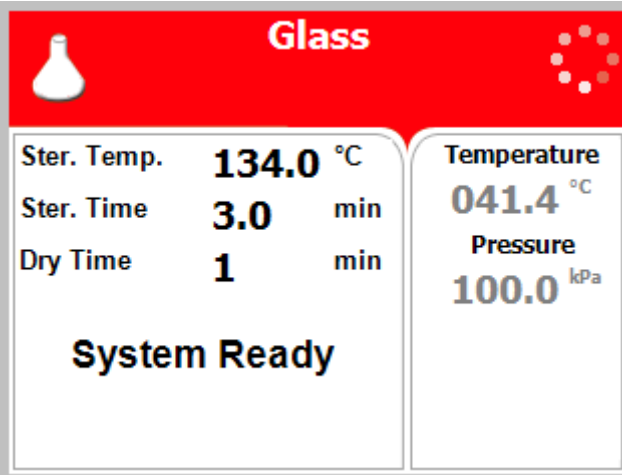

For glass instruments, when the manufacturer recommends autoclaving at temperatures of 134°C (273°F). Drying stage is available for PV (pre-vacuum) models only.

### Nominal parameters default settings

- Sterilization temperature: 134°C (273°F).
- Sterilization time: 3 minutes.
- Drying time: 1 minute. (PV – pre-vacuum models only).

**Operations sequence:**

- (PV, pre-vacuum models only) **Pulse low/Pulse high:** at one pulse it will build vacuum down to 25 kPa.
- **Water Inlet:** Water enters the chamber
- **Heating:** The chamber and is heated by actuation of electrical heaters until the sterilization temperature is reached.
- **Sterilization:** Sterilization temperature is maintained constant during the sterilization time.
- **Cooling:** N/A.
- **Fast Exhaust:** the steam is exhausted out of the chamber at a fast rate until pressure decreases to ambient pressure.
- (PV, pre-vacuum model only) **Drying:** vacuum is built up and the air pump is working.
- **Ending:** The system checks that End temperature and End pressure have been reached, and then releases the door.

## 5.2 Program 2: Plastic

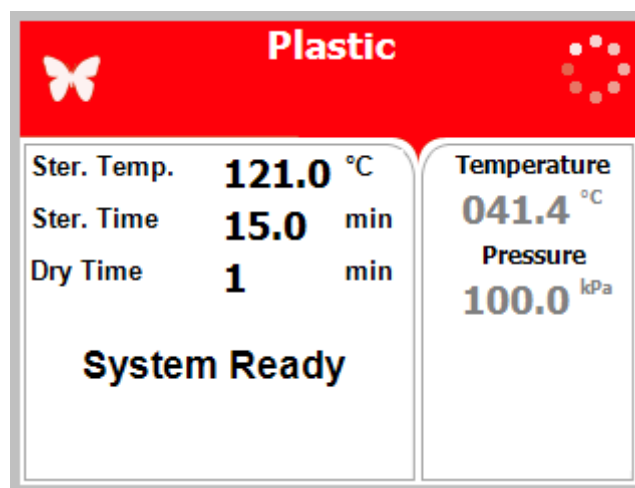

For plastic and other delicate instruments, when the manufacturer recommends autoclaving at temperatures of 121°C (250°F). Drying stage is available for PV (pre-vacuum) models only.

**Nominal parameters default settings**

- Sterilization temperature: 121°C (250°F)
- Sterilization time: 15 minutes
- Drying time: 1 minute (PV – pre-vacuum models only).

**Operations sequence:**

- (PV, pre-vacuum models only) **Pulse low/Pulse high:** at one pulse it will build vacuum down to 25 kPa.
- **Water Inlet:** Water enters the chamber
- **Heating:** The chamber is heated by actuation of electrical heaters until the sterilization temperature is reached.
- **Sterilization:** Sterilization temperature is maintained constant during the sterilization time.
- **Cooling:** N/A
- **Fast Exhaust:** the steam is exhausted out of the chamber at a fast rate until pressure decreases to ambient pressure.
- (PV, pre-vacuum models only) **Drying:** vacuum is built up and the air pump is working.
- **Ending:** The system checks that End temperature and End pressure have been reached, and then releases the door.

### 5.3 Program 3: Liquid A

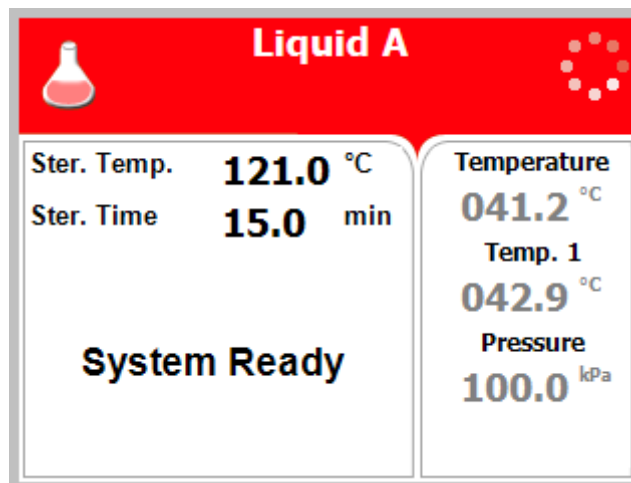

For liquids when the manufacturer recommends autoclaving at temperatures of 121°C (250°F) for 15 minutes.



#### Cautions!

**Both PT100 temperature sensors must be inside the bottles.**  
**For proper sterilization, fill the bottles with approximately the same amount of liquid.**

#### *Nominal parameters default settings*

- Sterilization temperature: 121°C (250°F)
- Sterilization time: 15 minutes

### Operations Sequence

- (PV, pre-vacuum models only) **Pulse low/Pulse high:** at one pulse it will build vacuum down to 25 kPa.
- **Water Inlet:** Water enters the chamber
- **Heating:** The chamber is heated by actuation of electrical heaters until the sterilization temperature is reached.
- **Sterilization:** Sterilization temperature is maintained constant during the sterilization time.
- **Cooling:** N/A
- **Slow Exhaust:** Steam is exhausted from the chamber at a slow rate, until it reaches the pressure of 30 kPa above the ambient pressure. Then steam is exhausted out of the chamber at a fast rate until pressure decreases to ambient pressure.
- **Drying:** N/A
- **Ending:** The system checks that End temperature and End pressure have been reached, and then releases the door.

## 5.4 Program 4: Liquid B – Waste

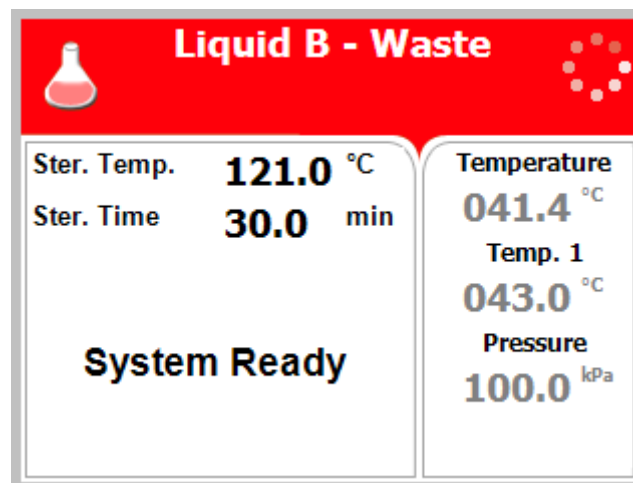

For liquids when the manufacturer recommends autoclaving at temperatures of 121°C (250°F) for 30 minutes, such as liquid waste.



### Cautions!

**Both PT100 temperature sensors must be inside the bottles.**  
**For proper sterilization, fill the bottles with approximately the same amount of liquid.**

**Nominal parameters default settings**

- Sterilization temperature: 121°C (250°F)
- Sterilization time: 30 minutes

**Operations Sequence**

- (PV, pre-vacuum models only) **Pulse low/Pulse high:** at one pulse it will build vacuum down to 25 kPa.
- **Water Inlet:** Water enters the chamber
- **Heating:** The chamber is heated by actuation of electrical heaters until the sterilization temperature is reached.
- **Sterilization:** Sterilization temperature is maintained constant during the sterilization time.
- **Cooling:** N/A
- **Slow Exhaust:** Steam is exhausted from the chamber at a slow rate, until it reaches the pressure of 30 kPa above the ambient pressure. Then steam is exhausted out of the chamber at a fast rate until pressure decreases to ambient pressure.
- **Drying:** N/A
- **Ending:** The system checks that End temperature and End pressure have been reached, and then releases the door.

**5.5 Program 5: Liquid A – Cooling (C – cooling models only)**

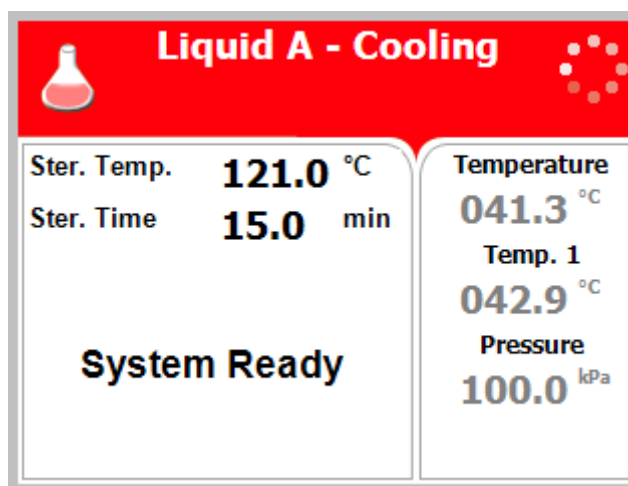

For liquids when the manufacturer recommends autoclaving at temperatures of 121°C (250°F). for 15 minutes.



### Cautions!

**Both PT100 temperature sensors must be inside the bottles.**

**For proper sterilization, fill the bottles with approximately the same amount of liquid.**

#### ***Nominal parameters default settings***

- Sterilization temperature: 121°C (250°F).
- Sterilization time: 15 minutes.

#### ***Operations sequence:***

- (PV, pre-vacuum models only) **Pulse low/Pulse high:** at one pulse it will build vacuum down to 25 kPa.
- **Water Inlet:** Water enters the chamber
- **Heating:** The chamber is heated by actuation of electrical heaters until the sterilization temperature is reached.
- **Sterilization:** Sterilization temperature is maintained constant during the sterilization time.
- **Cooling:** Forced cooling to the required end temperature, chamber pressure remains at approx. 300 kPa and the cooling valve is opened.
- **Fast Exhaust:** the steam is exhausted out of the chamber at a fast rate until pressure decreases to ambient pressure.
- **Drying:** N/A
- **Ending:** The system checks that End temperature and End pressure have been reached, and then releases the door.



## 5.6 Program 6: Liquid B – Waste Cooling (C – cooling models only)

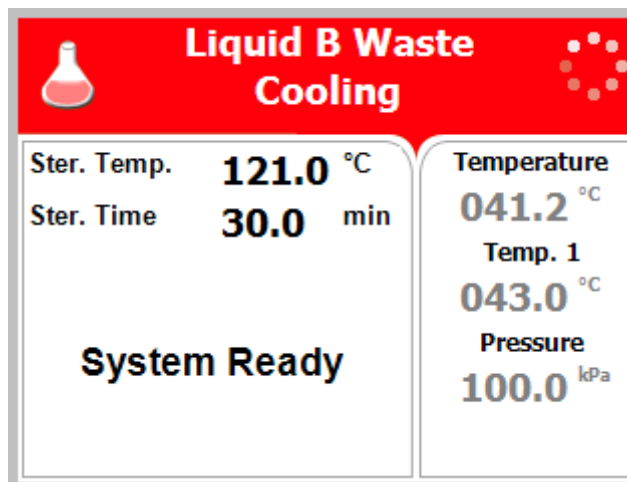

For liquids when the manufacturer recommends autoclaving at temperatures of 121°C (250°F) for 30 minutes, such as liquid waste.



### Cautions!

**Both PT100 temperature sensors must be inside the bottles.  
For proper sterilization, fill the bottles with approximately the same amount of liquid.**

### *Nominal parameters default settings*

- Sterilization temperature: 121°C (150°F).
- Sterilization time: 30 minutes.

### *Operations sequence:*

- (PV, pre-vacuum models only) **Pulse low/Pulse high:** at one pulse it will build vacuum down to 25 kPa.
- **Water Inlet:** Water enters the chamber
- **Heating:** The chamber is heated by actuation of electrical heaters until the sterilization temperature is reached.
- **Sterilization:** Sterilization temperature is maintained constant during the sterilization time.
- **Cooling:** Forced cooling to the required end temperature, chamber pressure remains at approx. 300 kPa and the cooling valve is opened.

- **Fast Exhaust:** the steam is exhausted out of the chamber at a fast rate until pressure decreases to ambient pressure.
- **Drying:** N/A
- **Ending:** The system checks that End temperature and End pressure have been reached, and then releases the door.

## 5.7 Program 7: Bio Hazard 1 (BH, bio-hazard models only)

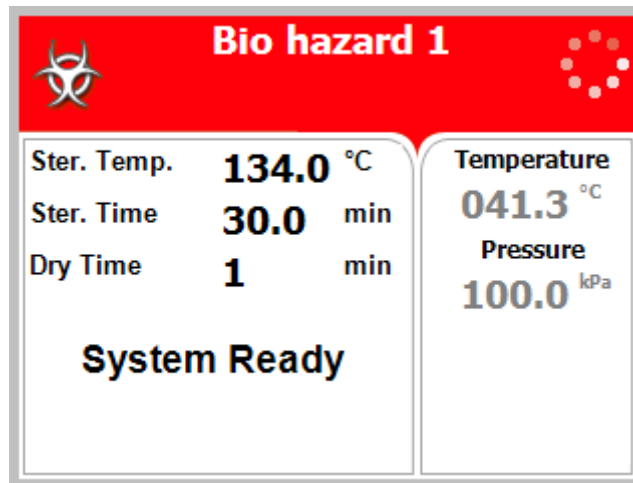

All exhaust from the chamber before completion of the Sterilization stage is performed through the bio-hazard filter. For instruments, when the manufacturer recommends autoclaving at temperatures of 134°C (273°F) for 30 minutes. Drying stage is available for PV (pre-vacuum) models only.

### ***Nominal parameters default settings***

- Sterilization temperature: 134°C (273°F)
- Sterilization time: 30 minutes
- Drying time: 1 minute. (PV – pre-vacuum models only).

### ***Operations sequence:***

- (PV, pre-vacuum models only) **Pulse low/Pulse high:** at one pulse it will build vacuum down to 25 kPa. **All exhaust from the chamber is performed through the bio-hazard filter.**
- **Water Inlet:** Water enters the chamber
- **Heating:** The chamber is heated by actuation of electrical heaters until the sterilization temperature is reached.
- **Sterilization:** Sterilization temperature is maintained constant during the sterilization time.

- **Cooling:** N/A
  - **Fast Exhaust:** the steam is exhausted out of the chamber at a fast rate until pressure decreases to ambient pressure.
- Note:** If the cycle fails, fast exhaust is performed through the bio-hazard filter. Some water may remain in the chamber after a failed cycle. To remove such water, press Start and repeat the cycle. If the problem persists, call for service.
- (PV, pre-vacuum models only) **Drying:** vacuum is built up and the air pump is working.
  - **Ending:** The system checks that End temperature and End pressure have been reached, and then releases the door.

## 5.8 Program 8: Bio Hazard 2 (BH, bio-hazard models only)

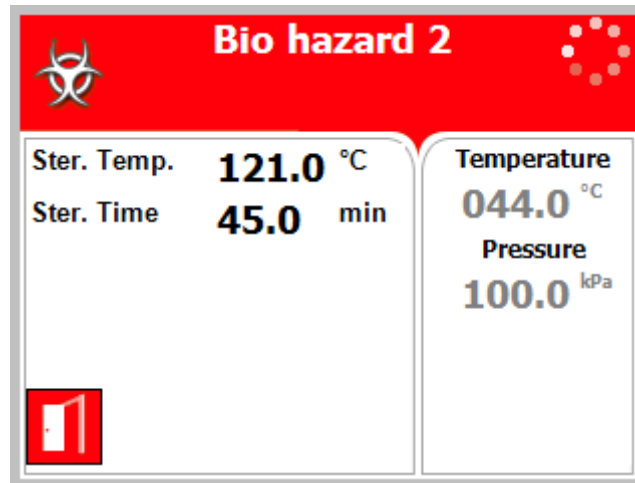

All exhaust from the chamber before completion of the Sterilization stage is performed through the bio-hazard filter. For instruments, when the manufacturer recommends autoclaving at temperatures of 121°C (250°F) for 45 minutes. Drying stage is available for PV (pre-vacuum) models only.

### ***Nominal parameters default settings***

- Sterilization temperature: 121°C (250°F)
- Sterilization time: 45 minutes
- Drying time: 1 minute. (PV – pre-vacuum models only).

### ***Operations sequence:***

- (PV, pre-vacuum models only) **Pulse low/Pulse high:** at one pulse it will build vacuum down to 25 kPa. **All exhaust from the chamber is performed through the bio-hazard filter.**
- **Water Inlet:** Water enters the chamber
- **Heating:** The chamber is heated by actuation of electrical heaters until the sterilization temperature is reached.
- **Sterilization:** Sterilization temperature is maintained constant during the sterilization time.
- **Cooling:** N/A
- **Fast Exhaust:** the steam is exhausted out of the chamber at a fast rate until pressure decreases to ambient pressure.
- **Note:** If the cycle fails, fast exhaust is performed through the bio-hazard filter. Some water may remain in the chamber after a failed

cycle. To remove such water, press Start and repeat the cycle. If the problem persists, call for service.

- (PV, pre-vacuum models only) **Drying:** vacuum is built up and the air pump is working.
- **Ending:** The system checks that End temperature and End pressure have been reached, and then releases the door.

## 5.9 Program 9: Bio Hazard Liquids (BH, bio-hazard models only)

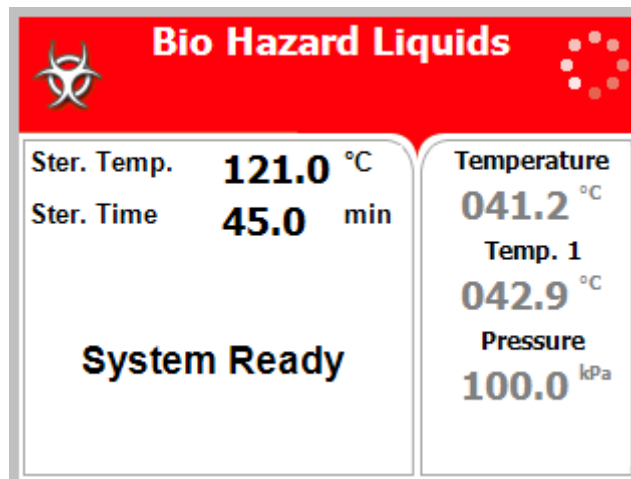

**All exhaust from the chamber before completion of the Sterilization stage is performed through the bio-hazard filter.** For liquids when the manufacturer recommends autoclaving at temperatures of 121°C (250°F) for 45 minutes.



### Cautions!

**Both PT100 temperature sensors must be inside the bottles. For proper sterilization, fill the bottles with approximately the same amount of liquid.**

### *Nominal parameters default settings*

- Sterilization temperature: 121°C (250°F)
- Sterilization time: 45 minutes

### *Operations sequence:*

- (PV, pre-vacuum models only) **Pulse low/Pulse high:** at one pulse it will build vacuum down to 25 kPa. **All exhaust from the chamber is performed through the bio-hazard filter.**
- **Water Inlet:** Water enters the chamber

- **Heating:** The chamber is heated by actuation of electrical heaters until the sterilization temperature is reached.
  - **Sterilization:** Sterilization temperature is maintained constant during the sterilization time.
  - **Cooling:** N/A
  - **Slow Exhaust:** Steam is exhausted from the chamber at a slow rate, until it reaches the pressure of 30 kPa above the ambient pressure. Then steam is exhausted out of the chamber at a fast rate until pressure decreases to ambient pressure.
- Note:** If the cycle fails, fast exhaust is performed through the bio-hazard filter. Some water may remain in the chamber after a failed cycle. To remove such water, press Start and repeat the cycle. If the problem persists, call for service.
- **Drying:** N/A
  - **Ending:** The system checks that End temperature and End pressure have been reached, and then releases the door.

### 5.10 Program 10: Vacuum Test (PV, pre-vacuum models only)

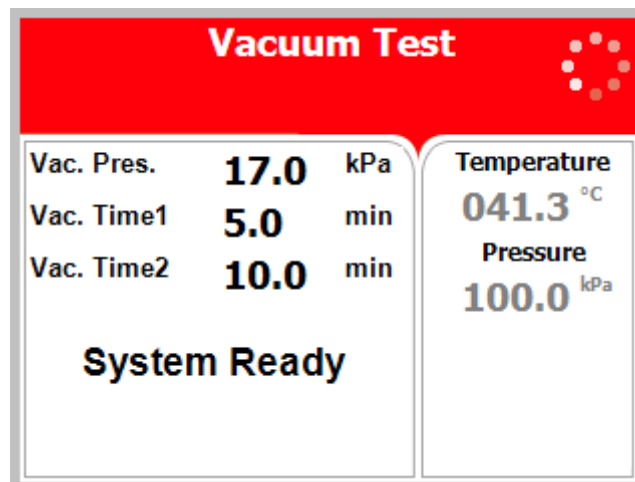

Vacuum Test is a test program with the following parameters:

#### ***Nominal parameters default settings***

- Vacuum pressure: 17.0 kPa
- Vacuum time 1: 5 minutes
- Vacuum time 2: 10 minutes

#### ***Operations sequence:***

- Vacuum is produced in the chamber down to P1=17 kPa. At this stage all the valves close. The autoclave remains in this stage for 5

minutes. This period enables the condition in the chamber to reach equilibrium.

- After the 5 minutes have elapsed, the printer records the pressure that is referred to as P2. At this point the test begins and lasts 10 minutes.
- At the end of the test, the printer records the results. The pressure at the end of the test is referred to as P3. The rate of change of P3-P2 shall not exceed 0.13 kPa/min.).

## 5.11 Program 11: Warm-Up

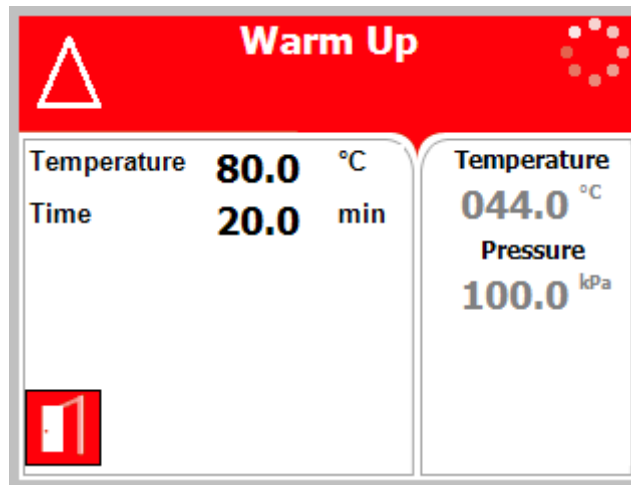

Pre-warming the chamber at 80°C (176°F) without drying.



**Caution!**

**This is not a sterilization program!**

### ***Nominal parameters default settings***

- Warm-up temperature: 80°C (176°F).
- Warm-up time: 20 minutes.

### ***Operations sequence:***

- **Pulse low/Pulse high:** N/A
- **Heating:** Water enters the chamber and is heated by actuation of electrical heaters until the warm-up temperature is reached.
- **Warm up:** Warm up temperature is maintained constant for the warm-up time.
- **Sterilization:** N/A.

- **Cooling:** N/A.
- **Fast Exhaust:** the steam is exhausted out of the chamber at a fast rate until pressure decreases to ambient pressure.
- **Drying:** N/A.

**Note:** Some water may remain in the chamber.

## 5.12 Program 12: Isothermal

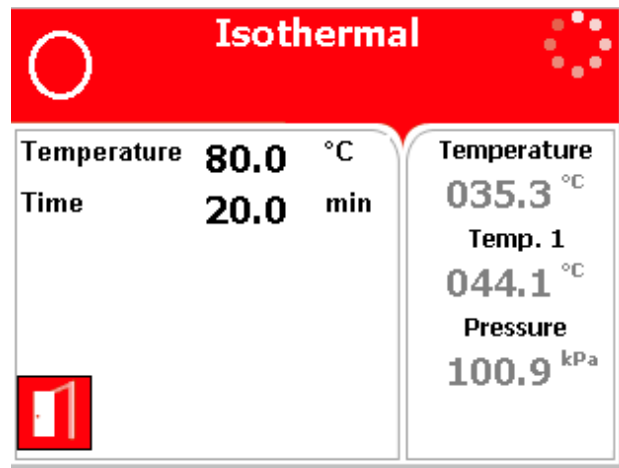

For liquids when the manufacturer recommends autoclaving at 60-100°C (140-212°F) with no drying. Recommending for melting of agar, pasteurization etc.



**Caution!**

**This is not a sterilization program!**

Put one PT100 inside the bottle, leave the second one hanging in the chamber outside the bottle (see below).

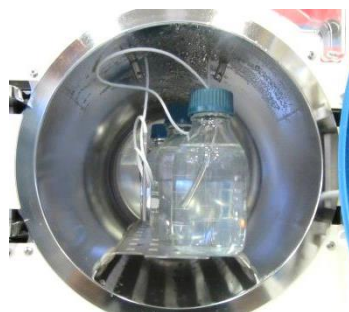

***Nominal parameters default settings***

- Heating temperature (default): 80°C (176°F).



- Heating time: 20 minutes.

**Operations sequence:**

- **Water Inlet:** Water enters the chamber
- **Heating:** The chamber is warmed up until the Keep-Heat temperature is reached inside the chamber.
- **Keep Heat:** Keep-Heat temperature is maintained constant for the preset Keep-Heat time.
- **Cooling:** N/A.
- **Fast Exhaust:** the steam is exhausted out of the chamber at a fast rate until pressure decreases to ambient pressure.
- **Drying:** N/A
- **Ending:** The system checks that End temperature and End pressure have been reached, and then releases the door.

**Note:** Some water may remain in the chamber.

### 5.13 Program 13: Air Mixture

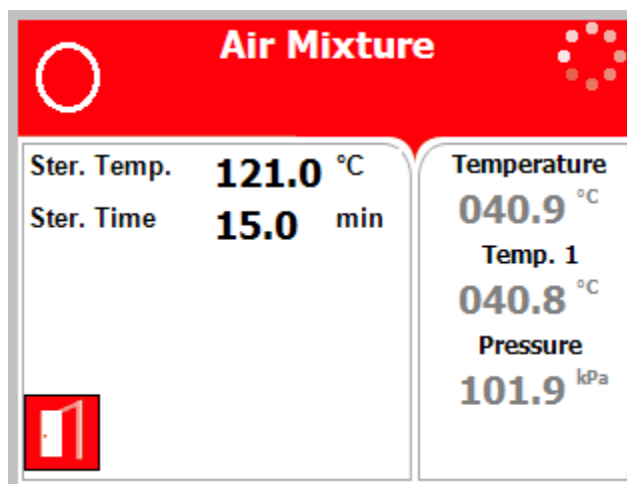

This program is intended for liquids in soft packages when the manufacturer recommends autoclaving at temperature of 121°C (250°F) for 15 minutes.

Sterilization is controlled in a way that the sterilization pressure remains approx. 30% above the theoretical pressure corresponding to the same temperature according to the steam table. These intends for prevent swelling or warping of the package.



**Cautions!**

**Both PT100 temperature sensors must be inside the bottles.  
For proper sterilization, fill the bottles with approximately the same amount of liquid.**

***Nominal parameters default settings***

- Sterilization temperature: 121°C (250°F).
- Sterilization time: 15 minutes.

***Operations sequence:***

- **Heating:** Air enters the chamber followed by steam that heats it up until the sterilization temperature is reached. Air adds pressure needed to prevent swelling or warping of soft plastic items. Chamber fan is used to mix air with steam.
- **Sterilization:** Sterilization is controlled in a way that the sterilization pressure remains approx. 30% above the theoretical pressure corresponding to the same temperature according to the steam table.
- **Cooling:** Forced cooling to the required end temperature, chamber pressure remains at approx. 300 kPa and the cooling valve is opened.
- **Fast Exhaust:** The steam is exhausted out of the chamber at a fast rate until pressure decreases to ambient pressure.
- **Drying:** N/A
- **Ending:** The system checks that End temperature and End pressure have been reached, and then releases the door.

**5.14 Program 14: Glass Test**

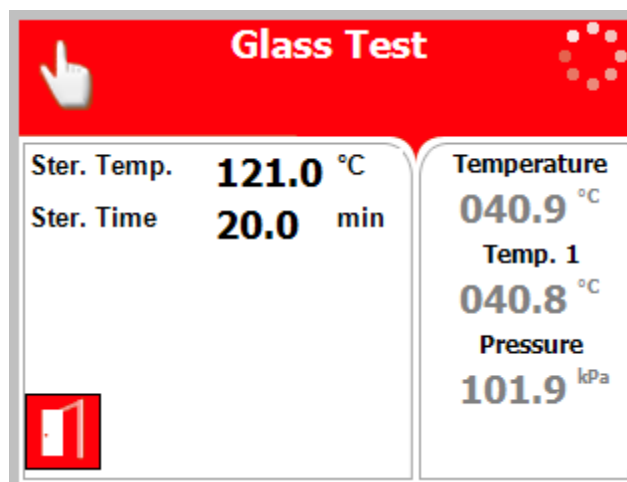

This cycle is intended to check the durability of the bottles for liquids when the manufacturer recommends autoclaving at temperatures of 121°C (250°F) for 20 minutes.



### **Cautions!**

**Both PT100 temperature sensors must be inside the bottles.  
For proper sterilization, fill the bottles with approximately the same amount of liquid.**

### ***Nominal parameters default settings***

- Sterilization temperature: 121°C (250°F).
- Sterilization time: 20 minutes.

### ***Operations sequence:***

- **Heating:** Steam enters the chamber and heats it up until the sterilization temperature is reached.  
**During the interval of the heating stage, between 100°C and 121°C, the heating rate is kept to approximately a rise of 1 degree per minute. This will make the last stage of the heating take approximately 21 minutes. This is to check the durability of the bottles.**
- **Sterilization:** Sterilization temperature is maintained constant during the sterilization time.
- **Cooling:** Forced cooling to the required end temperature, chamber pressure remains at approx. 300 kPa and the cooling valve is opened.  
**During the interval of the cooling stage, between 121°C and 100°C the cooling rate is kept to approximately a decrease of 1 degree per minute. This will make the last stage of the cooling take approximately 21 minutes. This is to check the durability of the bottles.**
- **Fast Exhaust:** The steam is exhausted out of the chamber at a fast rate until pressure decreases to ambient pressure.
- **Drying:** N/A
- **Ending:** The system checks that End temperature and End pressure have been reached, and then releases the door.

## 5.15 Program 15: Durham

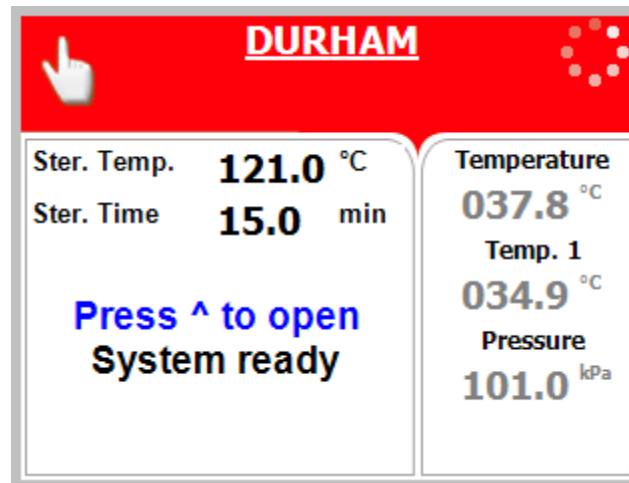

For liquids when the manufacturer recommends autoclaving at temperatures of 121°C (250°F) for 15 minutes.



### Cautions!

**Both PT100 temperature sensors must be inside the bottles.**

**For proper sterilization, fill the bottles with approximately the same amount of liquid.**

### *Nominal parameters default settings*

- Sterilization temperature: 121°C (250°F).
- Sterilization time: 15 minutes.

### *Operations sequence:*

- **(PV, pre-vacuum models only) Pulse low/Pulse high:** at one pulse it will build vacuum down to 25 kPa.
- **Heating:** Steam enters the chamber and heats it up until the sterilization temperature is reached.
- **Sterilization:** Sterilization temperature is maintained constant during the sterilization time.
- **Slow Exhaust:** Steam is exhausted from the chamber at a slow rate, until chamber temperature reaches 105°C.
- **Cooling:** Forced cooling to the required end temperature, chamber pressure remains at approx. 140kPa, and the cooling valve is opened.
- **Fast Exhaust:** The steam is exhausted out of the chamber at a fast rate until pressure decreases to ambient pressure.
- **Drying:** N/A

- **Ending:** The system checks that End temperature and End pressure have been reached, and then releases the door.

## 6. Screens

### 6.1 Screens following a completely successful cycle – "Cycle Ended"

1. System Ready

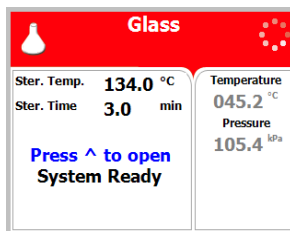

2. Pulse Low (ELPV model only)

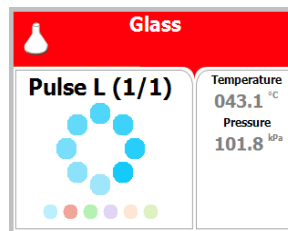

3. Pulse High (1/1) (ELPV model only)

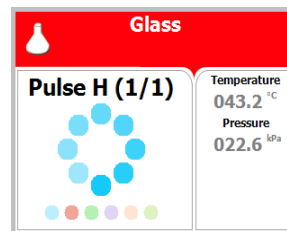

4. Heating

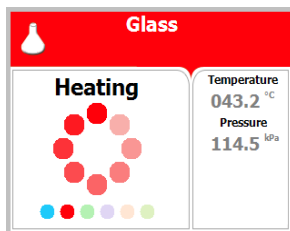

5. Sterilization

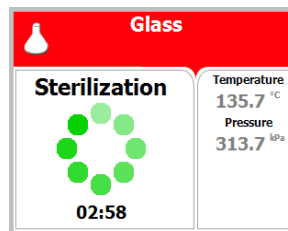

6. Exhaust

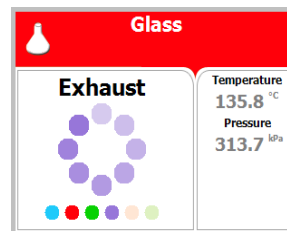

7. Drying (ELPV model only)

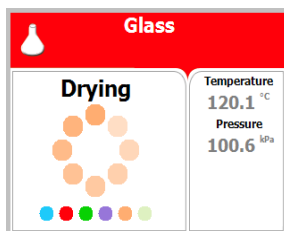

8. Ending

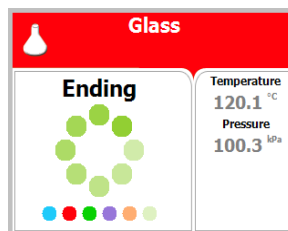

9. Cycle Ended

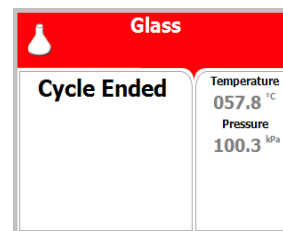

### 6.2 Screens following aborted cycles after complete sterilization stage

The sterilization phase ended successfully – cycle ended and the reason of failure is displayed

For example, the next two scenarios:

#### 6.2.1 Canceled by user after complete sterilization stage

The cycle ended successfully, the reason for aborted cycle is displayed.

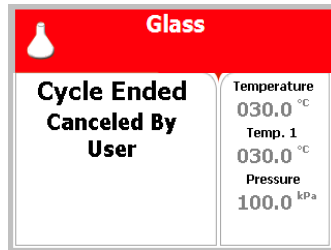

### 6.2.2 Pressure Time Error Failure occurrence after complete sterilization stage

The cycle ended successfully, the reason of failure is displayed.

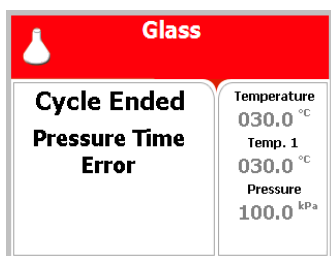

## 6.3 Screens following a fail cycle:

In this case, the display becomes yellow, a warning sign  and the reason of failure will be displayed.

For example the next two scenarios:

### 6.3.1 Failure according to Pressure Time Error

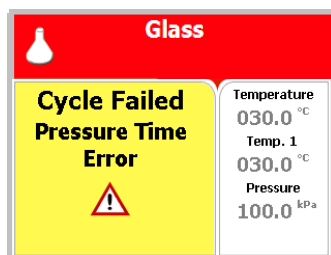

### 6.3.2 Failure according to Cancellation by user before complete sterilization stage

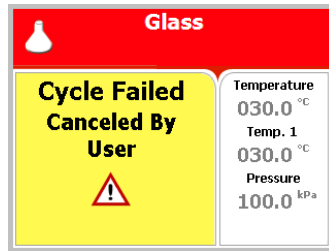

When "Cycle Failed" appears on the screen, the user shall press **START/STOP** key in order to delete the "Cycle Failed" message

An example for all displayed warnings according to Cycle Failed:

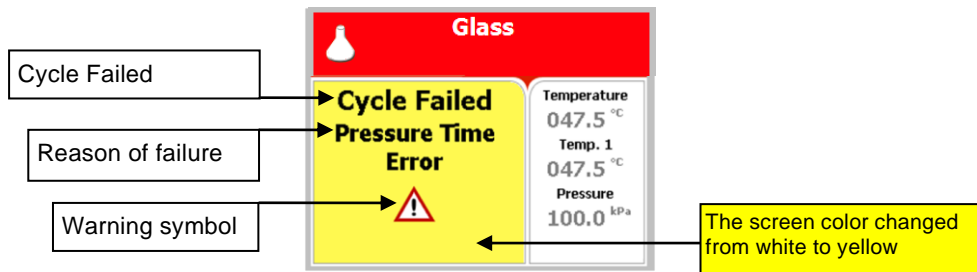



## 7. Printer

---

### 7.1 Printer Output

The printing is on thermal paper with 24 characters per line and contains the following information:

- Date:
- Time:
- Ser. Num:
- Model:
- Version:
- Cycle Num:
- Cycle:
- Ster Temp:
- Ster Time:

When the sterilization cycle begins the printer starts printing the above data.

After the preliminary printing, the autoclave starts performing the sequence of operations of the cycle. The measured values of temperature and pressure are printed at fixed time intervals, according to the phase of the process, as shown in the table on the next page.

The data is printed from the bottom up, beginning with the date and ending with "Cycle Ended". For an aborted cycle, "Cycle Failed" and the Error message are printed (refer to "Displayed Error Messages/Symbols").

For an example of a typical printout, see next page.

**Note:** Please note that the print out goes from the bottom upwards.

Printer output			Description
Operator:	_____		To be filled in manually by operator
Time:	12:14:47		Time sterilization cycle ended
Status: Cycle Ended			
00:24:43	101.3	099.7	Cycle finished time
D 00:31:23	101.9	023.4	The time, temperature and pressure during drying
D 00:28:23	106.2	109.7	The time, temperature and pressure during exhaust
E 00:23:43	107.0	107.4	The time, temperature and pressure during exhaust
E 00:22:08	134.5	311.9	The time, temperature and pressure during exhaust
CLK 2:	12:12:10:00		Sterilization Process End time as registered by two clocks
CLK 1:	12:12:10:00		
S 00:22:07	134.5	311.6	The time, temperature and pressure during sterilization
S 00:22:06	134.5	311.6	The time, temperature and pressure during sterilization
S 00:21:06	134.6	311.0	The time, temperature and pressure during sterilization
S 00:20:06	134.5	310.1	The time, temperature and pressure during sterilization
S 00:19:06	134.8	311.1	The time, temperature and pressure during sterilization
S 00:18:06	134.5	315.8	The time, temperature and pressure during sterilization
CLK 2:	12:08:08:00		Sterilization Process Start time as registered by two clocks
CLK 1:	12:08:08:00		
H 00:18:04	134.4	315.1	The time, temperature and pressure during heating
H 00:16:35	128.9	268.4	The time, temperature and pressure during heating
H 00:13:35	116.3	110.9	The time, temperature and pressure during heating
A 00:08:48	089.6	077.1	The time, temperature and pressure during air removal
A 00:05:48	091.3	049.4	The time, temperature and pressure during air

Printer output			Description
			removal
W 00:03:22	092.5	015.2	The time, temperature and pressure during water inlet
A 00:03:05	092.8	017.1	The time, temperature and pressure during air removal
A 00:00:05	098.3	101.6	The time, temperature and pressure during air removal
<b>TIME</b>	<b>°C</b>	<b>kPa</b>	
End Temp:	120.0 °C		
Ster Time:	7.0min		Sterilization time for selected program
Ster Temp:	134.0°C		Sterilization temperature in chamber for selected program
Cycle:	Unwrapped pouches		Cycle name
Cycle Num:	000082		Cycle number
Version:	1.0.00.00		Version A.B.CC.DD = 1.0.00.00 A: Door Type: Single Manual = 1 B: Vacuum Type = 0 C: Total number of Input/Output functionality that are not as default = 00 D: Total number of parameters values that are not as default = 00
Model:	LABSCI 15L		Model name
Ser. Num:	000000000001		Model Serial number
Time:	11:50:05		Time sterilization cycle started
Date:	9/FEB/2010		Date sterilization cycle started
-----			
Time:	08:51:39		Time of turning on
Date:	9/FEB/2010		Date of turning on
POWER ON			The device is turned on
Time:	00:00:00		Time of turning off
Date:	9/FEB/2010		Date of turning off
POWER OFF			The device is turned off

Legend			
W	Insert Water	S	Sterilization stage
F	Steam Flush	CLK 1	Real Time Clock
A	Air removal stage	CLK 2	Software clock
H	Heating stage	E	Exhaust stage
K	Keep Heat (Optional)		
D	Drying Stage (ELPV Model only)		

## 7.2 Printer Handling

### 7.2.1 Maintenance

Wipe off the soiling on the printer surface with a dry soft cloth with a weak neutral detergent. After that, wipe the printer with a dry cloth.

### 7.2.2 Setting paper

#### PLUS II Front view

- 1-Paper mouth
- 2-STATUS Led
- 3-OPEN key (for paper roll compartment opening)
- 4-FEED key
- 5-Paper roll compartment
- 6-Paper end sensor

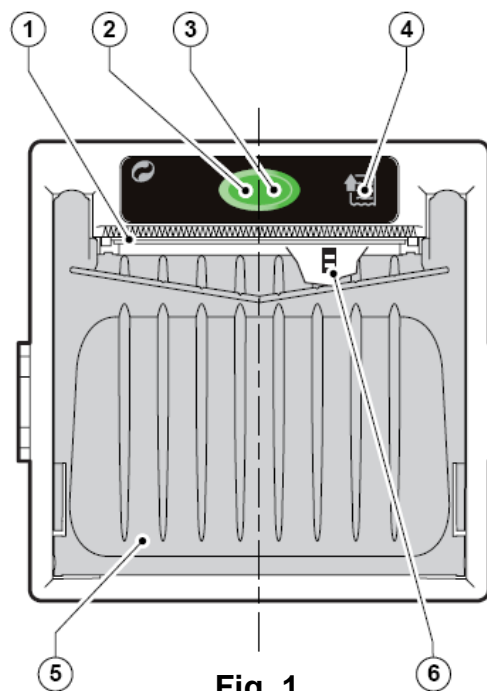

**Fig. 1**

1. Open the printer's cover door (1) by pulling it up (see Fig. 2).

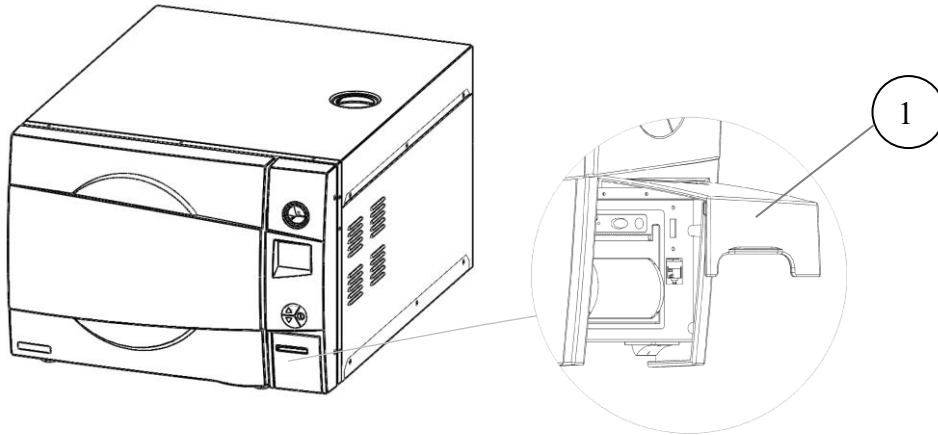

**Fig. 2**

2. Press the OPEN key to open the printer cover as shown (see Fig. 3/1). Handle the paper cutter carefully not to cut your hand.
3. Place the paper roll making sure it unrolls in the proper direction as shown (see Fig. 3/2).
4. Take out the paper and re-close the cover as shown (see Fig. 3/3) the printer cover is locked.
5. Tear off the exceeding paper using the jagged edge (see Fig. 3/4).

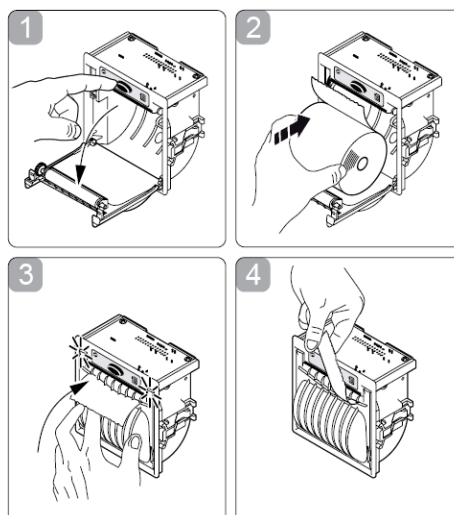

**Fig. 3**

6. Close the printer's cover door (1) by pulling it down (see Fig. 2), with the tip end of the paper emerging from the slot.

### 7.2.3 Treating the thermal papers:

- Store the papers in a dry, cool and dark place.
- Do not rub the papers with hard substance.
- Keep the papers away from organic solvent.



#### **Cautions!**

**Never disassemble the printer. Failure to follow this instruction may cause overheating or burning of the printer or the AC adapter. Or an electric shock, which may lead to fires or accidents.**

**Never use the printer in a place of extreme humidity or any place where it can possibly be splashed by any liquids. If any liquids get into the printer, it could lead to fire, electric shock, or other serious accidents.**

**Never touch the thermal head immediately after printing because it becomes very hot. Make sure that the thermal head is cool before setting papers or cleaning the thermal head.**

**Power OFF the printer in any of the following cases:**

- The printer does not recover from an error.
- Smoke, strange noise or smells erupt from the printer.
- A piece of metal or any liquid touches the internal parts or slot of the printer.

## **7.3 Filling the Water Reservoir**

Remove the water reservoir cover. Pour distilled water into the reservoir through the opening on top of the autoclave until it reaches the base of the safety valve holder. The water quantity is approx. 7.1 liters (1.56 US gal.).

Use only water having the characteristics as per table in para. 2.13. Tap water may clog the system. A clogged system causes increase of pressure, which prevent temperature from rising.



**Caution!**

**Under no circumstance should water be filled above the safety valve holder.**

## **7.4 Condense collecting tray**

Since residual condense may accumulate between the water briar and the door, we recommend to place a condense-collecting tray (1 – supplied with the autoclave) under the autoclave's door. Verify that this tray is placed under the front edge of the chamber.



---

## 8. Installation

---

### 8.1 Placing



**Caution!**

The sterilizer is not portable or hand-held equipment; it is a fixed device so it is forbidden to move it.

The sterilizer must be placed on a rigid and leveled surface. The stand must be able to withstand the load of the device and loaded material.

1. **Counter top**

Able to support a minimum of 105 kg (231.5 lb).

2. **Counter space**

Min. 92cmW x 72cmD (28"W x 36"D) \* (see unit dimensions).

**When changing the autoclave location the door should remain open for at least 5 minutes in order to set the atmospheric pressure**

#### 8.1.1 Placing the Autoclave

Keep the back and the sides of the autoclave approximately 50 mm (2") away from the wall to allow ventilation and to facilitate the device disconnection.

If placed in a cabinet, verify that the rear of the cabinet is open to allow ventilation.

Insufficient space for ventilation may result in an increase of the autoclave's temperature that may damage the instrument.

It is recommended that enough space be left around the autoclave to give a technician access for servicing the machine.

#### 8.1.2 Connections to Utility Supplies

Plug the power cord into the power supply output as specified in sec. 3.5 (Utilities).



## 8.2 Lifting and carrying



### Caution!

**Before moving the autoclave, Make sure that the electric cord is disconnected from the power, and there is no pressure in the chamber and in the generator.**

To avoid injuries, lifting and carrying should be done with at least two persons or by using a fork-lift or any other mechanical aid.

**Do not drop the device!**

---

## 9. Preparation before Sterilization

---

The purpose of packaging and wrapping of items for sterilization is to provide an effective barrier against sources of potential contamination in order to maintain sterility and to permit aseptic removal of the contents of the pack. Packaging and wrapping materials should permit the removal of air from the pack, penetration of the sterilizing water vapor into the pack and removal of the sterilizing vapor.

The basic principle determining the size, mass and contents of instrument and hollowware packs is that the contents are sterile and dry immediately on completion of the drying cycle and removal of the pack from the sterilizer chamber.

Instruments to be sterilized must be clean, free from any residual matter, such as debris, blood, pads or any other material. Such substances may cause damage to the contents being sterilized and to the sterilizer.

1. Before use, check inside the autoclave chamber to ensure that no items have been left from the previous cycle.
2. Immediately after use, clean instruments thoroughly to dispose of any residue.
3. It is recommended to wash instruments with an ultrasonic cleaner, using detergent and mineral-free water.
4. Launder textile wraps prior to reuse.
5. After cleaning, rinse instruments for 30 seconds. (Follow manufacturer's instructions on the use of products for cleaning and lubricating instruments after using the ultrasonic cleaner).
6. Materials, including materials used for inner wraps, shall be compatible with the item being packed and the sterilizing method selected.
7. Do not place materials to be sterilized directly on the chamber's wall. Place the material only on trays, rack, etc.

### 9.1 Instruments

1. Before placing an instrument on the sterilizer tray, make sure that instruments which are not of the same metal, (stainless steel, carbon steel, etc.) are separated and placed on different trays.
2. Place empty containers upside down to prevent accumulation of water.

**Note:** Check manufacturer's instructions for the sterilization of each item.

3. In case carbon steel instruments are placed on the stainless steel tray, the tray should be lined with a towel or paper wrap before placing the instruments on the tray. There should be no direct contact between the carbon steel and the stainless steel tray.
4. All instruments must be sterilized in an open position.

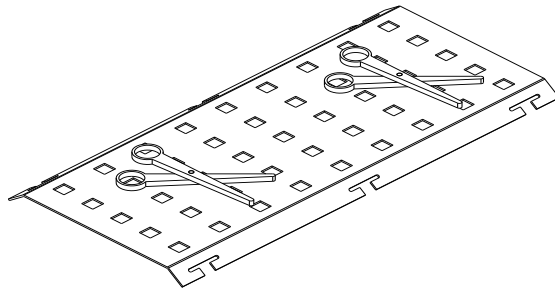

5. Use single-use wraps once only and discard after use.
6. Place a sterilization indicator strip on the tray.
7. Place instruments with ratchets opened and unlocked or clipped on the first ratchet position.
8. Disassemble or sufficiently loosen multiple-part instruments prior to packaging to permit the sterilizing agent to come into contact with all parts of the instrument.
9. Tilt on edge items prone to entrap air and moisture, e.g. hollowware, so that only minimal resistance to removal of air, the passage of steam and condensate will be met.
10. Load items within the boundaries of the tray so that they do not touch the chamber walls.
11. The operator may use racks to allow for adequate separation of packaged instruments.
12. Load trays in such a way as to allow steam to move freely among all items.
13. Once a week, use a biological spore test indicator in any load to make sure sterilization is performed efficiently.
14. Make sure that all instruments remain apart during the sterilization cycle.
15. Empty canisters should be placed upside-down, in order to prevent accumulation of water.

## **9.2 Wrapped Instruments**

1. Wrapped instruments should be packed in material that promotes drying such as autoclave bag, autoclave paper, and muslin towels.
2. It is highly recommended to utilize the Tuttnauer™ Pouch Rack. This rack allows the operator to place pouches on their side, thus increasing

the capacity of the autoclave significantly and promoting better drying of the instruments. Contact your dealer for details.

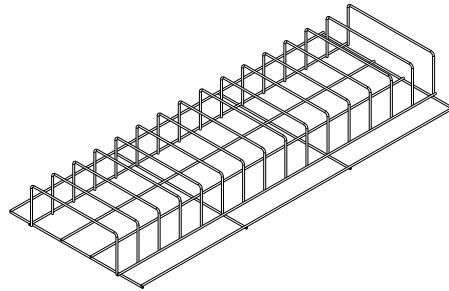

3. Verify that the packaging method is in accordance with good practice approach and the packaging materials are in accordance with the applicable standards (e.g. EN868 series).

### 9.3 Packs

1. Place packs upright on the tray, side by side.

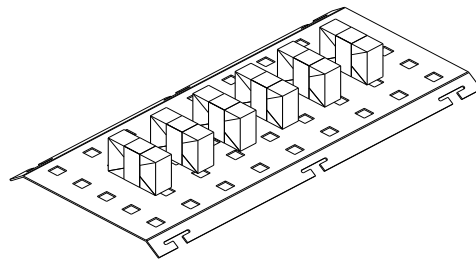

2. Packs should not touch the chamber walls.
3. Pack instrument sets in a manner that prevents damage to delicate items.
4. Pack hollowware sets so that all openings face the same direction and so that the contents cannot move inside the pack.
5. Load packs of folded operating room drapes with layers vertical, allowing air to be removed from the packs rapidly.
6. Do not place packs of hollowware and trays of instruments above textile packs or soft goods in order to avoid wetting caused by condensation from items above.
7. Load items packed in flexible packaging materials on edge with paper to laminate, or flat with the paper surface downwards.

**Note:** The manufacturer's recommendations shall be observed, concerning the sterilization data for each type of material.

## 9.4 Tubing

When placing tubing on the tray, make sure that both ends are open, without sharp bends or twists.

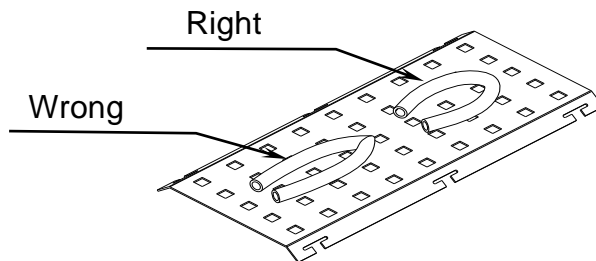

## 9.5 Liquids

Use only heat-proof glass, filled 2/3 full.

Ensure that the glass container is covered but not sealed to prevent pressure build-up.

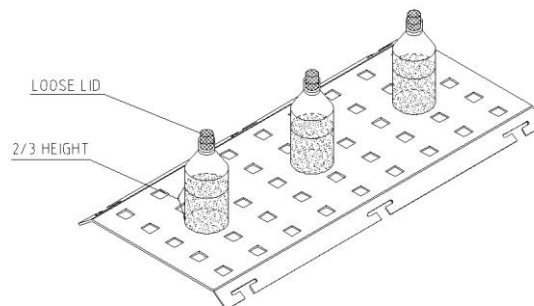

### Note:

For proper sterilization, ensure all the bottles are filled with approximately the same amount of liquid.



## 10. Operating Instructions

### 10.1 Turning on the autoclave

- To start the system, turn on the main switch (1), located under the printer cover.

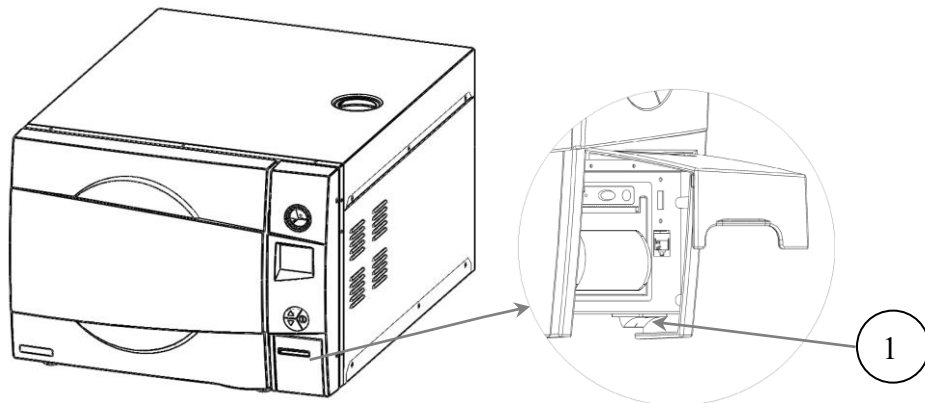



The door is equipped with an electrical cylinder. This electrical cylinder perform the automatic opening and closing of the door.

### 10.2 Opening the door

In order to open the door, follow the next steps:

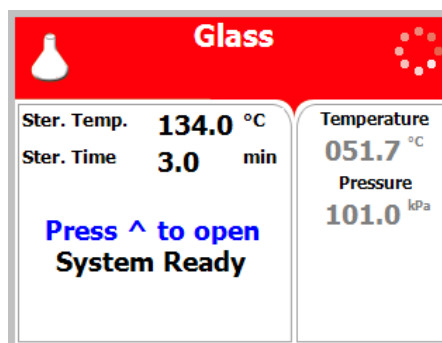
When the door is closed, the screen below will be displayed:



Press the  key in order to open the door

The following screen will be displayed:



If the door has opened successfully, the following screen will appear

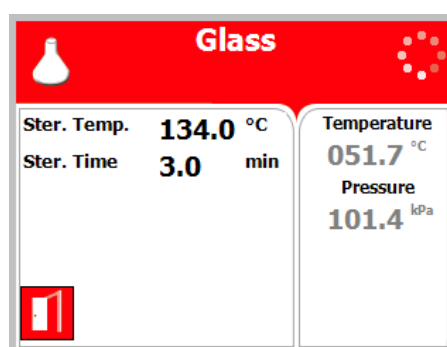

### 10.3 Safety

Protective equipment and clothes and other safety instructions should be implemented in accordance with local and national regulations and/or rules!

For proper sterilization - Do not overload the chamber. Only autoclavable products shall be used; please refer to the manufacturer instructions for sterilization of unknown materials or instruments.

### 10.4 Loading

- Load the autoclave properly according to instructions in sec. 9 PREPARATION BEFORE STERILIZATION.

Please Mind:

- Compatible material
- Proper weight

### 10.5 Operation

1. Select the program.
  - **UP** key: next program.
  - **DOWN** key: previous program.



**Attention:**

**Selecting a program is possible only when the door is open.**

2. Verify that you chose the required cycle.
3. If the autoclave is equipped with a printer verify that a paper roll is inserted in the printer. If not - insert as per para. 5.2.

## 10.6 Closing and locking the door

In order to close the door, follow the following steps:

When the door is open, the screen below will be displayed:

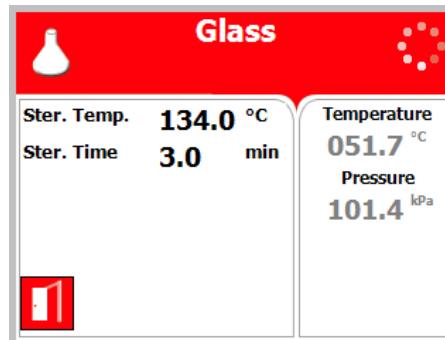

1. Close the door:



**Warning!**

**In order to close and lock the door push the door to the wall of the autoclave chamber (for about 10 seconds) until the "System Ready" message appears as shown below!**



While the door is locking the following screen will be displayed:



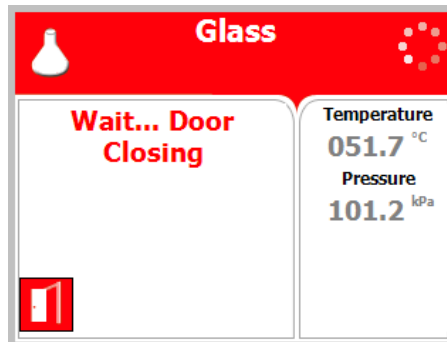

When the door is properly locked, open door symbol  will be replaced by the "System Ready" message as shown below:

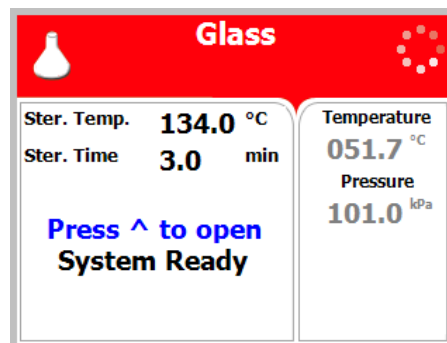

## 10.7 Starting cycle

Start the cycle by pressing the START/STOP key.

If your autoclave supports *CFR 21 part 11* standard, perform the following procedure:

**SELECT USER** screen will be displayed:

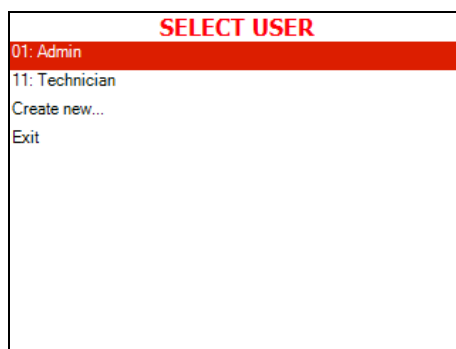

1. Enter the Enter Code screen by moving the cursor to your username (Use **Up** and **Down** keys) and pressing **START/STOP** key. The following screen will be displayed:

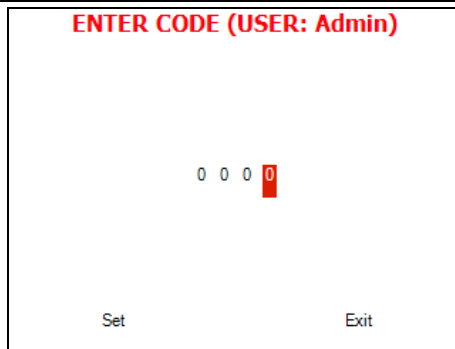

2. 0000 is displayed on the screen with the cursor blinking on the right digit.
3. To increase or decrease the digits, press the **UP** or **DOWN** keys.
4. Set your password, then move the cursor to **Set** by pressing the **START/STOP** key.
5. When **Set** is blinking, press the **UP** or **DOWN** keys to return to the program screen.

The autoclave starts performing sequence of operations. The actual measured values of pressure and temperature are displayed continuously and printed every minute at STE stage, and every 5 minutes at the other stages. The phase in progress is displayed at the right side of the upper line as WATER, HEAT, STER., and EXH.

If the operator presses the START key and the door is not completely closed, the process will not start.



#### **Caution!**

**Do not touch the strainer's cover, mounted on the exhaust line, during and short after operation.**

**Touching the hot strainer's cover may cause severe injuries.**

## **10.8 Unloading**

- When the cycle ended successfully (including pressing the **START/STOP** key, or any failure, after completing the sterilization stage) message "Cycle Ended" (and the relevant failure message, if applicable) is displayed on the screen.
- Verify that there is no pressure in the chamber, according to the reading on the display. Only then you may open the door.
- When opening the door, open the door approx. 2.5cm (1") for a few seconds, to enable removal of residual steam and condense, and then complete the opening of the door.



**Warning!**

**To avoid severe injuries from hot steam when opening the door:  
It is strictly forbidden to lean on the autoclave.  
It is strictly forbidden to place your hand or any part of your  
body over the door.**

- Wear heat-resistant gloves or use the tray handle to remove the load from the autoclave
- On completion of the cycle, the load shall be visual inspected to ascertain that the load is dry, and that sterilization indicators have made the required color change.

## **10.9 Stopping the process and cancelling the ERROR message**

- It is possible to stop the program while the autoclave is operating. Pressing the **START/STOP** key at any stage of the process stops the operation. If the cycle was aborted before completing the sterilization stage, it will leave the load unsterilized.
- At the end of the aborted process (before completing the sterilization stage), "**Cycle Failed**" message, error message and a warning symbol  are displayed on the screen. Refer to "Displayed Error Messages/Symbols".
- Pressing the **START/STOP** key cancels the displayed message and enables opening the door.
- If the door is not opened, the vacuum pump will stop automatically after 30 minutes (ELPV model only).



**Warning!**

**The load has not completed a sterilization cycle, therefore it is not sterile. Handle it as contaminated load.**

## **10.10 Unloading**

1. When the cycle ended, press START/STOP key to verify the status. Message "Cycle Ended" (and the relevant failure message, if applicable) is displayed on the screen.
2. Verify that there is no pressure in the chamber, according to the reading on the display. Only then you may open the door.
3. Open the autoclave. (see sec. 12.2 Opening the door)



### **Warnings!**

**To avoid sever injuries from hot steam when opening the door:**

**It is strictly forbidden to lean on the autoclave.**

**It is strictly forbidden to place your hand or any part of your body over the door.**

**Wear heat-resistant gloves or use the tray handle to remove the load from the autoclave**

**To avoid severe injuries from hot steam when opening the door:**

**It is strictly forbidden to lean on the autoclave.**

**It is strictly forbidden to place your hand or any part of your body over the door.**

**Since the autoclave is defined as a bio-hazard autoclave, a failed cycle may leave un-sterilized waste in the chamber. Therefore failed cycle will be followed by a slow exhaust and the door will remain locked. To enable opening the door perform a new cycle. The door can be opened only after a successful cycle.**

4. To release the door locking at the end of operation, press the UP key. The same applies at power up after fail. Rotate the handle counter-clockwise to pull out the locking arms handle from the retaining brackets.
5. Wear heat-resistant gloves or use the tray handle to remove the load from the autoclave
6. On completion of the cycle, the load shall be visual inspected to ascertain that the load is dry, and that the colour of the sterilization indicators turned to the required color.
7. At the end of each working day close the main water valve.

## **10.11 Cycle by Clock mode**

This mode enables the operator to define the time of the beginning of the cycle. The maximum possible delay is 24 hours.

For more details, see sec. 6.8.1 "START CYCLE BY CLOCK"



### **Caution!**

**Before moving the autoclave, verify that the electrical, air and water connections have been disconnected, and there is no pressure in the chamber.**

# 11. Checking and Changing Parameters and Other Data

Bacsoft control panel allows changing parameters of the cycle and of the system, exporting various data to, and importing from, a USB device or to the printer, and some other options.

Cycle parameters are changeable for Custom programs only (see Duplicate cycles), with the exception of the Temperature sensors, Displayed inputs, and Dry Time.

## 11.1 Browsing through the menus

Now you will learn how to browse through the folders. When you read the Directories and subdirectories chapter with links to specific menus, you will need to know how to browse through the folders using the autoclave control panel. Below is the instruction.

Login as User (see 7.4). The Main menu screen appears. To browse through the menus:

1. Press the Up and Down keys to scroll through the menus.
2. Press the Start/Stop key to enter the next screen (i.e. to get one level down).
3. Repeat steps 1 and 2 to enter the next screen until you get to required screen.

Below are the example screens for the following menu: Cycle Parameters\ Drying\ Dry Time:

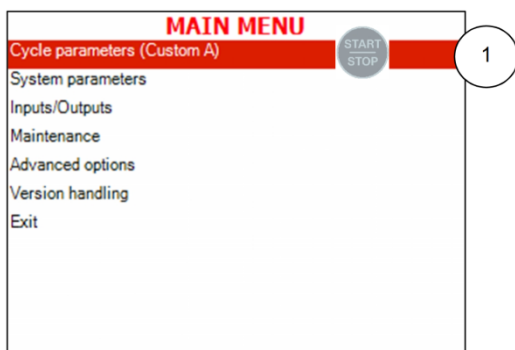

Login as Technician (see 1.4). The Main menu screen appears.  
Press the Start/Stop key to enter the Cycle parameters menu.

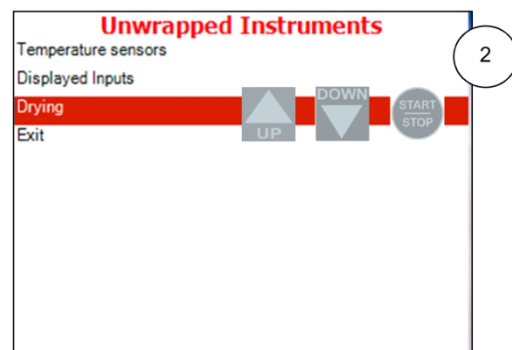

Press the Up and Down keys to scroll through the menus until you get to Drying, then press the Start/Stop key to enter the Drying menu.

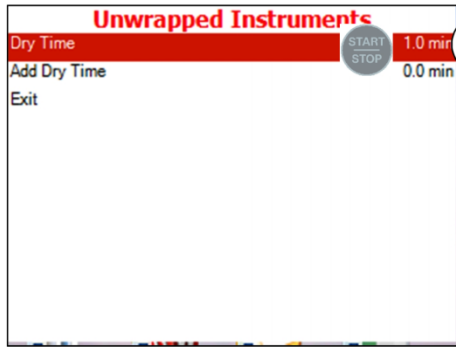

Press the Start/Stop key again to enter the Dry Time menu.

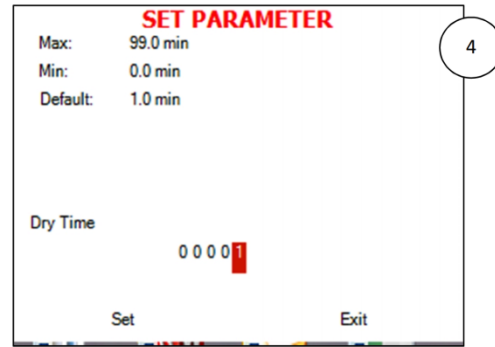

Now you have reached the required screen: Changing the dry time parameter. The path is: **Cycle parameters\Drying\Dry Time.**

**Note:** To exit every screen and to return to the previous screen (to get one level up):

- move the cursor to Exit by pressing the UP or DOWN keys and then press the Start/Stop key.
- or -
- press the UP and DOWN keys simultaneously.

In the next chapter you will see how to change the required parameter as desired.

## 11.2 Changing a Parameter

You have browsed through the menus and reached the parameter changing screen as explained above. Now you can change the required parameter as desired. To do so:

1. Enter the required value as follows:
  - Press the Up and Down keys to change the value of the digit.
  - Press the Start/Stop key to move the cursor to the next digit to the left.
2. When finished, press the Start/Stop key repeatedly until you move the cursor to Set.
3. Press the Up or Down key to confirm the new value and to exit the parameter changing screen.

Below is the typical parameter changing screen:

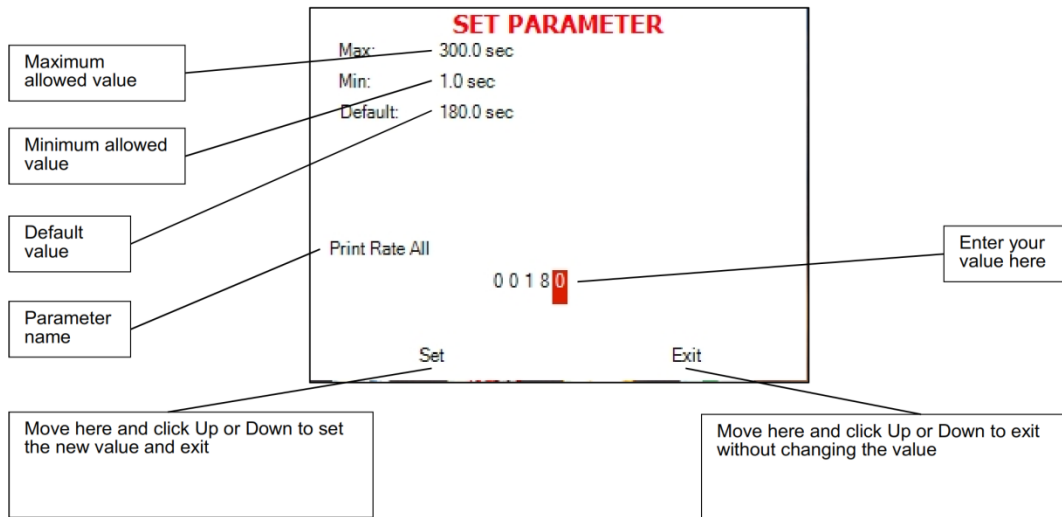

**Note:** Please note the maximum and minimum values for this parameter shown on the screen. Your value must be within these boundaries.  
Below is the example of changing the Dry time parameter on the screen used in the previous section:

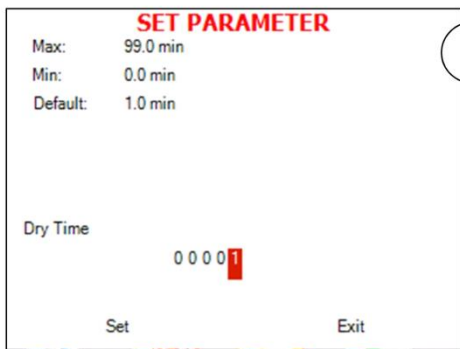

Browse to Changing dry time screen as explained in the previous chapter

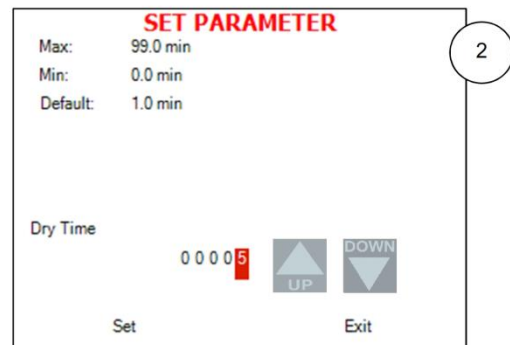

Use Up and Down keys to change the value of the digit

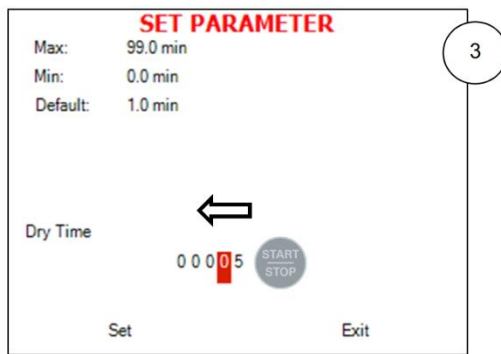

Press the Start/Stop key to move the cursor to the next digit to the left.

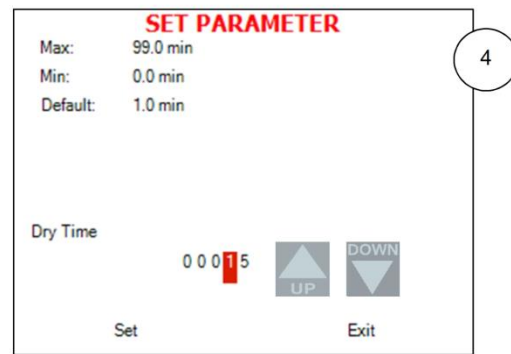

Press the Up and Down keys to change the value of the digit

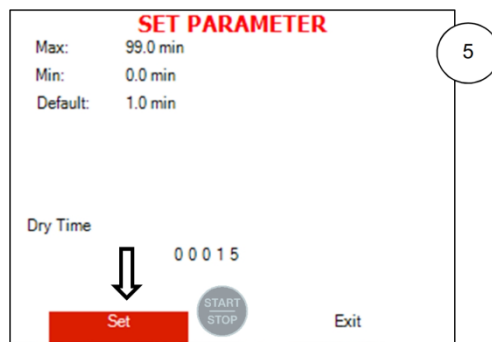

When finished, press the Start/Stop key repeatedly until you move the cursor to Set.

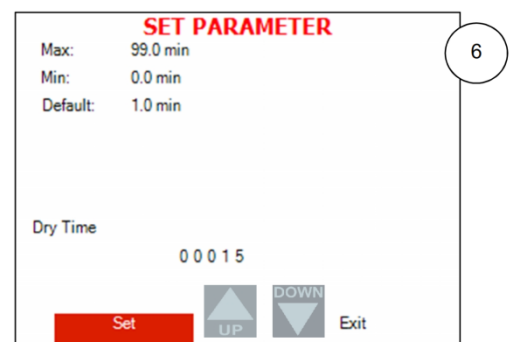

Press the Up or Down key to confirm the new value and to exit the parameter changing screen.

**Note:** To exit every screen and to return to the previous screen:

- move the cursor to Exit by pressing the UP or DOWN keys and then press the Start/Stop key
- or -
- press the UP and DOWN keys simultaneously

### 11.3 Quick options screen

When the autoclave is on and no cycle is running, press Up and Down keys simultaneously to enter the Quick options screen. Most of the options require login, and their availability depends on user authority (user, or technician). Login command is the last line on this screen. Quick options are options available without login.



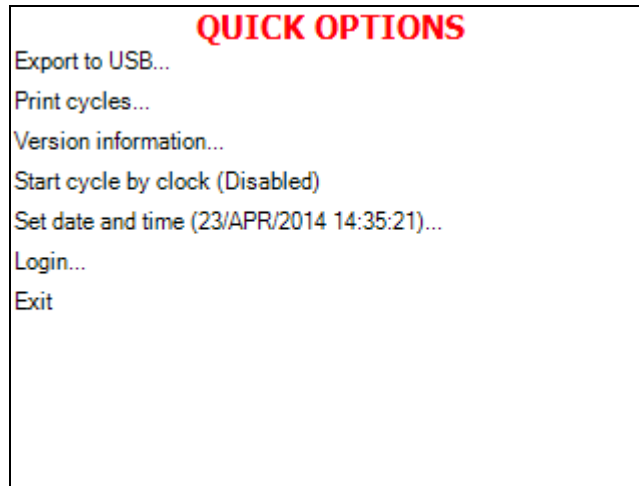

Below you can find instructions how to login and enter the Main menu. Section 7.1 above explains how to browse through the menus; section 7.2 explains how to change a parameter.

Below is the explanation of some Quick Options.

### 11.3.1 Version Information

This directory allows viewing information of the current, factory default, and previous software versions.

1. Enter the Version information screen.

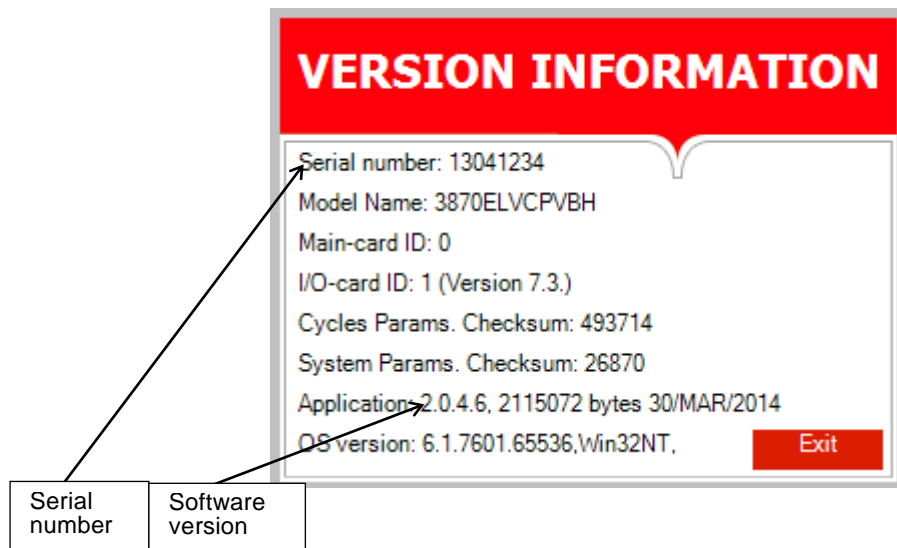

### 11.3.2 Start cycle by clock

This subdirectory enables the operator to start the cycle at the time set by this parameter.

1. Enter the Start cycle by clock screen. The following screen will appear:



On the Start cycle by clock screen, the time is displayed in the form "HH:MM". The hour range is 24 hours (i.e. from "0" to "24").

#### **Setting the time to start the cycle**

1. Move the cursor to the Time field.
2. Set the required time.

#### **Enabling the Start Cycle by Clock**

1. Set the starting time .
2. Move the cursor to Enabled. Press Up or Down key to enable starting cycle by clock.

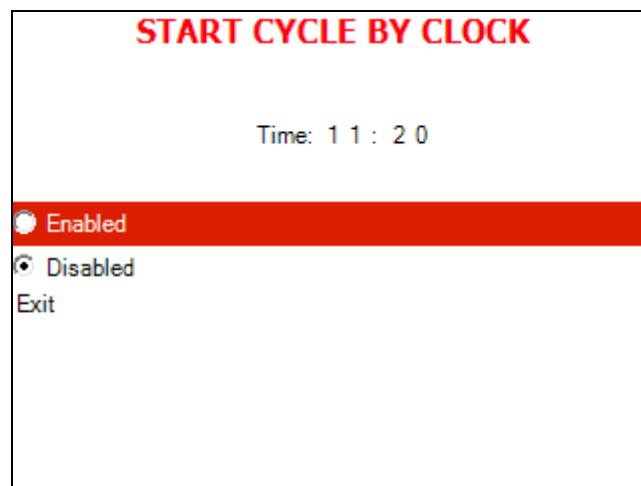

1. Exit the Enabling the Start Cycle by Clock. The start cycle by clock icon appears on the display:

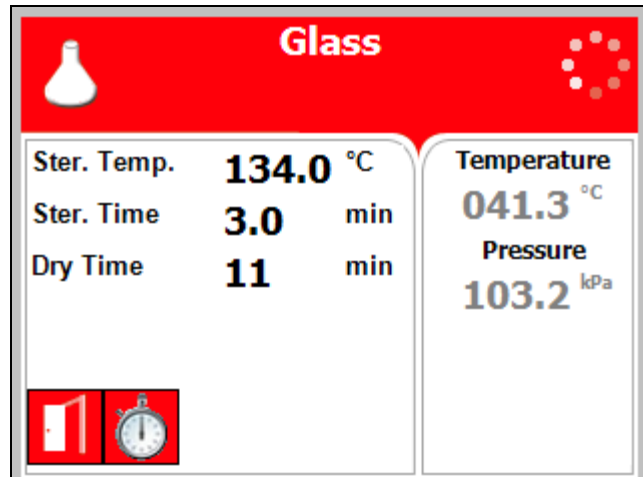

### Disabling the START CYCLE BY CLOCK

2. On the Start Cycle by Clock screen, move the cursor to Disabled. Press Up or Down key to disable Starting cycle by clock.
3. Exit the Enabling the Start Cycle by Clock.

### 11.3.3 Set date and time

This subdirectory enables the operator to set date and time.

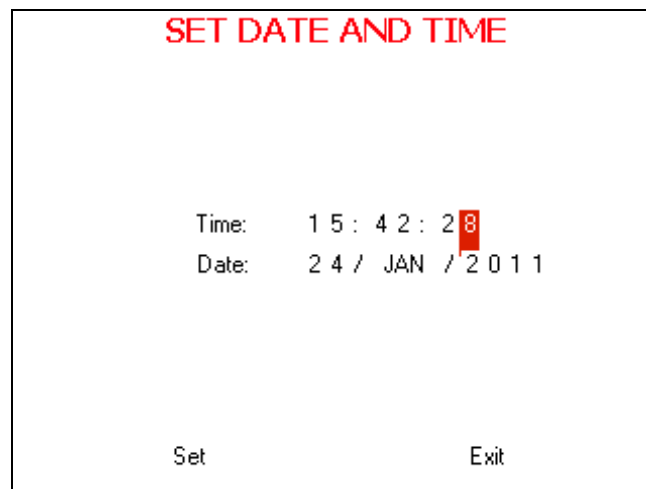

On the Set date and time screen, the time is displayed in the upper row in the form "HH:MM:SS". The hour range is 24 hour (i.e. from "0" to "24"). The date is displayed in the lower row in the form "DD: MMM: YYYY".

1. Set time and date
2. Exit the Set date and time screen. The following screen will appear:



**Caution!**

After setting time and date, turn the autoclave off and then on again.

## 11.4 Logging in and entering the Main menu

Below you can find instructions how to login and enter the Main menu. Section 7.1 above explains how to browse through the menus, section 7.2 explains how to change a parameter.

When the autoclave is on and no cycle is running, press the up and down keys simultaneously to enter the *Quick Options* screen (see 7.3). On this screen you can either proceed to login (see below) or choose one of the quick options available without login. To login as user:

1. On the Quick Options screen, choose login.  
Select user screen appears.

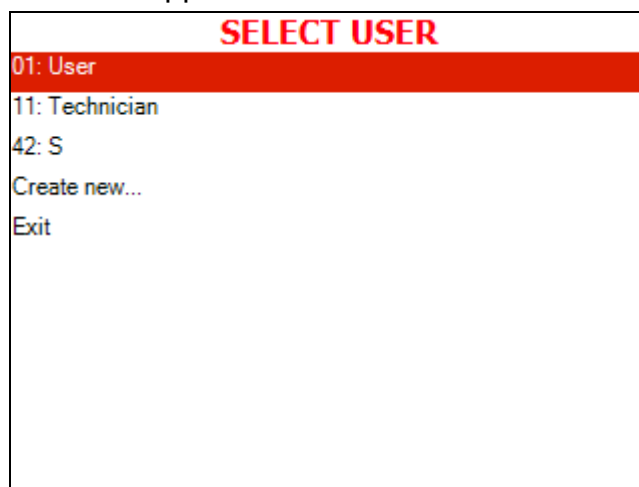

2. Choose User, then press the Start/Stop key to enter. The following screen will appear:

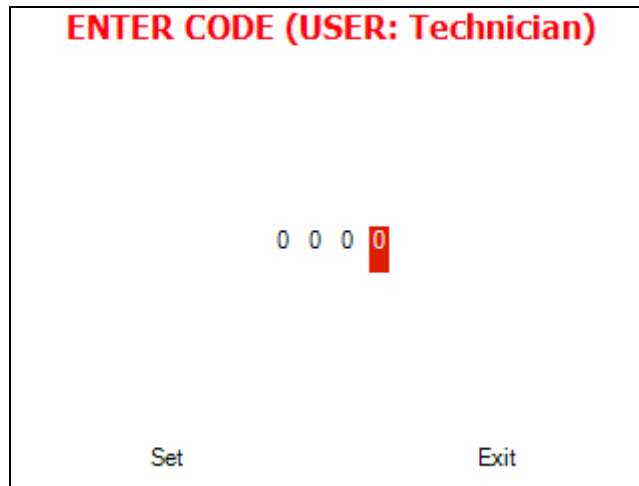

0000 is displayed on the screen with the cursor flashing on the right digit.

- Set the code to 0001. You will get to the Main menu.

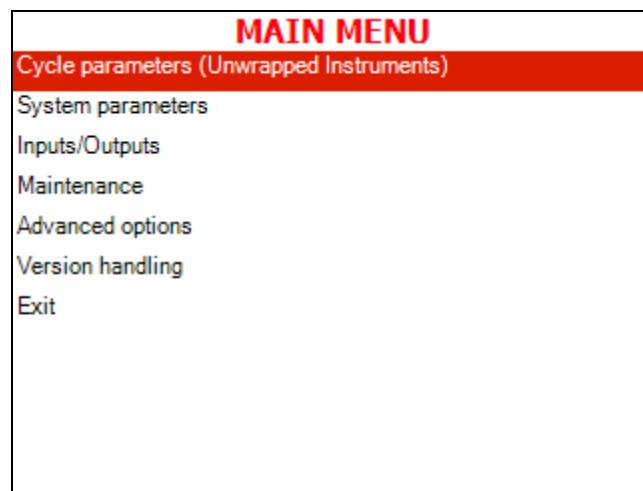

Below is the list and the explanation of some options available to user on the Main Menu.

## 11.5 Changing parameters

Bacsoft control panel provides an interface that consists of control screens available through an easy scrollable menu tree.

**To learn how to scroll through the menus, change the parameters, and perform some other functions using our three-button keypad, see 7.1 and 7.2.**

Below is the typical parameter changing screen:

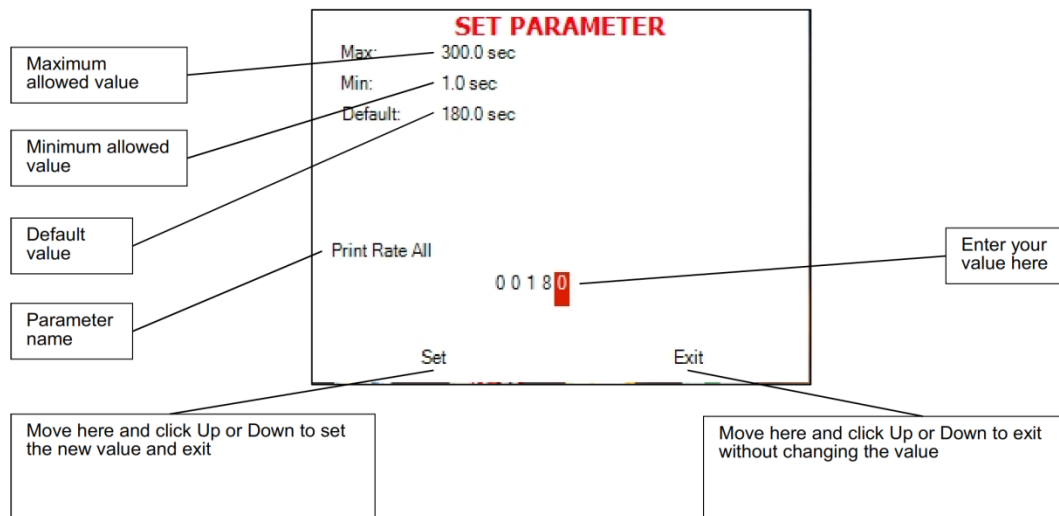

## 11.6 System Parameters

This menu is listing the system parameters that are the same for all cycles. Browse to the following folder:

Main menu\System parameters

You will see the following screen:

<b>SYSTEM PARAMETERS</b>	
Print Rate All	180.0 sec
Print Rate Sterilization	60.0 sec
Screen Saver	90.0 min
Pressure Calibration High	300.0 kPa
Pressure Calibration Low	25.0 kPa
Temperature Calibration High	130.0 °C
Temperature Calibration Low	60.0 °C
Cycle Print Gap	2.0
Exit	

### 11.6.1 Screen Saver

In this menu you can define the screensaver delay time, i. e. how long the keyboard will be untouched before the screensaver activates.

Browse to the following folder:

System parameters\Screen Saver

Change the parameter as desired.

## 11.7 Maintenance

Maintenance procedures provided by *Bacsoft* software allow you additional tests and USB input/output options.

Browse to the following folder:

Main menu\Maintenance

You will see the following screen listing the maintenance options:

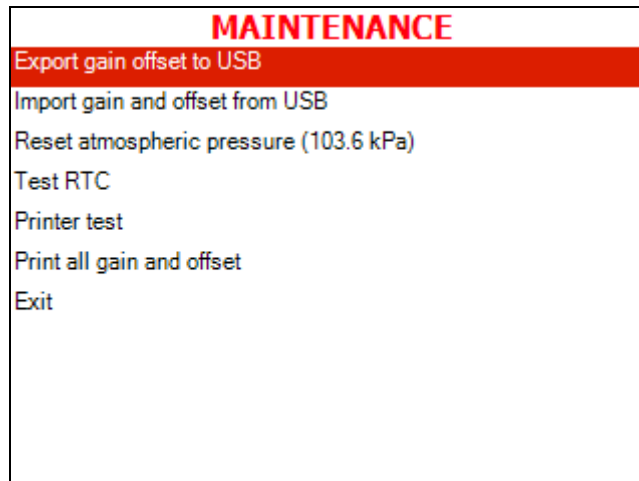

Below is the instruction for autoclave's maintenance menu.

### 11.7.1 Reset atmospheric pressure

In this menu you can reset the atmospheric pressure value. To do so:

1. Browse to the following folder:

Maintenance\Reset atmospheric pressure

The following screen will appear:



2. Leave the door open for 2 minutes at least. Ambient temperature should be less than 45°C.

**Note:** Please reset the atmospheric pressure when you install the autoclave for the first time, and each time you relocate or calibrate the autoclave.

### 11.7.2 Printer test

In this menu you can check the normal function of the printer. The printer will print the list of errors.

Browse to the following folder:

Maintenance\Printer test

The following screen will appear to confirm that the test has been done.

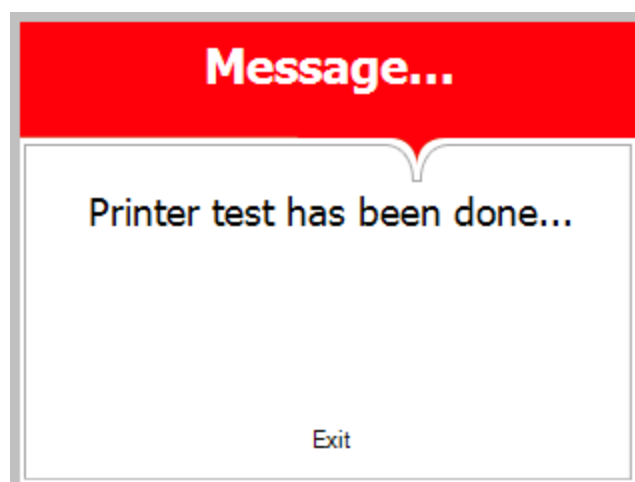

See the printout shown in the Printer handling chapter of this manual.

## 11.8 Cycle parameters

The Cycle parameters menu includes parameters of a specific sterilization program (cycle). Browse to the following folder:

Main menu\Cycle parameters

You will see the following screen listing the cycle parameters:

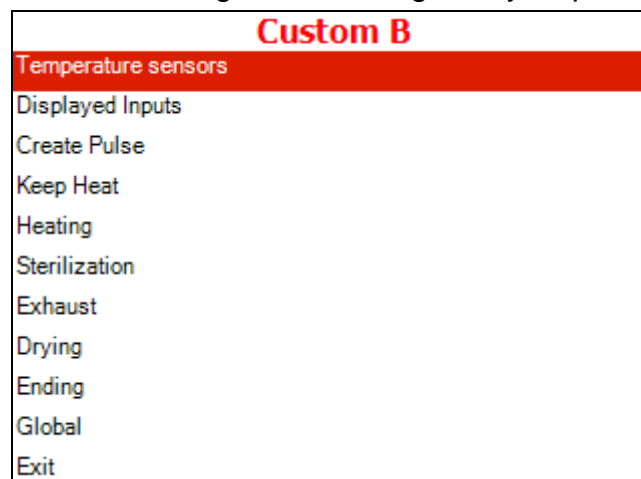



**Note:** For all the standard sterilization cycles, and for Bowie and Dick test, the only changeable cycle parameter is dry time (you will not see other parameters on your screen). For the custom cycles created by duplication, and for the Warm Up cycle, more options are changeable. Operator is not allowed to create custom cycles; only authorized technician can do this.

### 11.8.1 Dry Time

This parameter defines duration of the drying stage for the cycle.

1. Browse to the following folder:  
Cycle parameters\Drying\Dry Time
2. Change the parameter as desired.

Drying stage is divided into two stages. For each stage you can set the total time, on time and off time. So during the Dry First Stage, the heating elements are on for the time set in Dry Heat On 1, then they go off for the time set in Dry Heat Off 1, and then this sequence is repeated during the entire Dry First Stage Time. The same is true for the Dry Second Stage.

### 11.8.2 Add Dry Time

This subdirectory allows you to change the Dry Time parameter for the current cycle.

Browse to the following folder:

- Cycle parameters\Drying\Add Dry Time  
Change the parameter as desired.

---

## 12. Service and Maintenance Instructions

---

### 12.1 Preventive and Scheduled Maintenance

The maintenance operations described in this chapter have to be fulfilled periodically to keep the device in good condition and to reduce the breakdown time to a minimum.

The user can easily execute these operations in accordance with further instructions.

The owner of the autoclave is responsible to order an authorized technician to perform the periodical tests and preventive maintenance operations, as specified in sec. 12.1.3.2.

Use only mineral-free water as detailed in sec. 3.11 (water quality).



#### Warning

**Before carrying out any preventive maintenance operation, ensure that the electrical cord is disconnected and there is no pressure in the autoclave.**

#### 12.1.1 Daily by the operator

Clean door gasket with a soft cloth. The gasket should be clean and smooth. A mild soapy solution may be used.

#### 12.1.2 Weekly by the operator

1. Clean the water sensor in the rear of the chamber with a damp cloth or sponge. Cleaning the dirt off the sides of the sensor is more important than the tip (see sec. 12.5).
2. Check the interior of the autoclave. If the autoclave is dirty it requires cleaning as follows:

Take out the tray holder and trays. Clean the tray holder, trays and chamber's interior (especially its bottom part) with a cleaning agent & water. Wipe off the sediments from the chamber bottom with a sponge. You may use diluted Chamber Brite™ solution as cleaning agent. To prepare this solution, pour one bag of Chamber Brite™ into 3/4 – 1 liter of warm mineral-free water. Immediately after cleaning, rinse the tray holder, trays and chamber's interior with water to avoid stains on the metal.



**Caution!**

**Do not use steel wool or steel brush as this can damage the chamber!**

3. Clean the outer parts of the autoclave with a soft cloth.
4. Replace mineral free water in the reservoir.

**Autoclaves without recycling of mineral free water**

If the autoclave was not used, drain the water from the mineral free water reservoir once a week, and refill with fresh mineral-free water or distilled water (see sec. 12.3).

**For autoclaves with recycling of mineral free water. (Not available in Europe!)**

Once a week, or after 20 cycles (whichever comes first), drain the water from the mineral free water reservoir, and refill with fresh mineral-free water or distilled water (see sec. 12.3).

**12.1.3 Periodically**

***By the operator***

1. Once a month, activate the safety valve (see sec. 12.4).
2. Once a month clean the strainer as per sec. 12.7. Cleaning frequency may be reduced according to experience.
3. Check the door gasket every 12 months and replace it if required (shall be done by a qualified technician).

***By a qualified technician***

**Every 6 months**

- Tighten the screws of the heaters and the electrical connections at the heaters, valves and connectors in the control box.
- Replace the air filter, every 6 months or after 1000 cycles (the shorter period).

**Once a year**

These operation shall be done by an authorized technician.

- Checking the continuity of the grounding connections.
- Calibration of the temperature and pressure.
- Perform validation of the autoclave.
- Checking the precise operation of the earth leakage relay.
- Checking that the autoclave is leveled.
- Checking the safety elements; safety valve, cut-off thermostat, door locking mechanisms.
- Checking the operation sequences, the sterilization parameters etc.

- Checking the water reservoir, piping, plastic parts and electric wires.
- Checking and tightening the piping joints to avoid leakage.
- Checking and tightening all screw connections in the control box, heaters and valves and instrumentation.

**5 years**

- Checking the door device for excessive wear.
- Performing safety tests: pressure vessel, efficiency, electrical, according to local rules or regulations.

**To be performed only, by an authorized inspector.**

## **12.2 Replacing the Air Filter**

To facilitate drying the instruments with the door of the chamber closed, models EA are equipped with an air compressor and HEPA filter (0.2µm). During the drying stage the compressor draws air through the HEPA filter and forces the circulation of that air through the heated chamber to remove moisture from the wrapped instruments. The filtration of the air is performed by the bacteriological filter. Frequency of replacement will be determined depending on the usage of the autoclave and the surrounding environment.

The filter is mounted in an opening on the right sidewall of the autoclave enclosure, this is to allow easy access for replacing it, (see picture below).

To replace the filter proceed as follows:

1. Remove the filter cover (2) by turning the cover counterclockwise until it is released.
2. Remove the filter (5) from the filter cover by pulling the filter apart from the filter cover
3. Cut the tie wrap (4) fixing the flexible tube (3) connecting the filter to the copper pipe, and pull off the filter.
4. Replace the filter with a new one. Connect the filter (5) to the flexible tube (3) and tighten it with a tie wrap (4).
5. Connect the filter to the filter cover by pressing the filter (5) into the hole in the cover (1).
6. Insert the filter to its place inside the autoclave and reassemble the filter cover by turning it a ¼ turn clockwise. Verify that the cover is fastened well in its place.

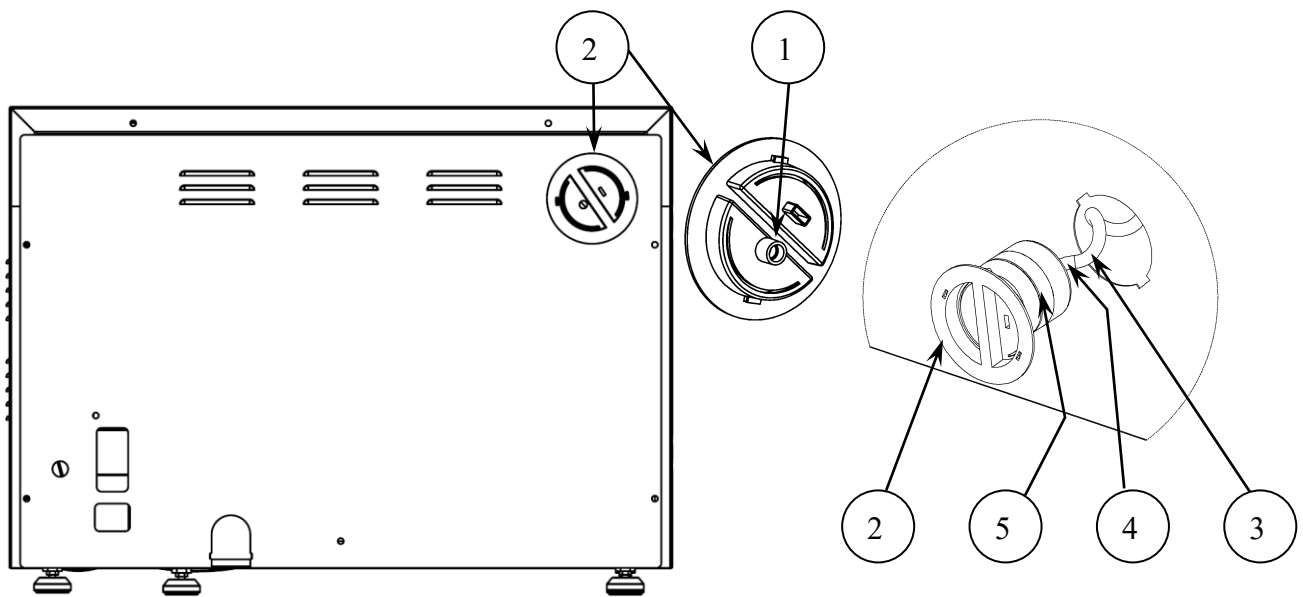

## 12.3 Draining the Reservoir



### Caution!

**Before starting, Make sure that the electric cord is disconnected and there is no pressure in the autoclave.**

The drain valve is located on the front left side of the autoclave after the door is opened. The function of the drain valve is to drain the water reservoir.

1. Connect the silicone hose, supplied with the autoclave, to drain into a bucket.
2. Turn drain valve counterclockwise to the open position.
3. Fully drain the reservoir.
4. With a quart of tap water flush out the reservoir.
5. Turn drain valve clockwise to the close position.
6. Connect the electric cord to power source.
7. Fill the reservoir with distilled water to just below the safety valve (see sec. 9.1).
8. Turn on the main power switch.
9. The autoclave is now ready for use.

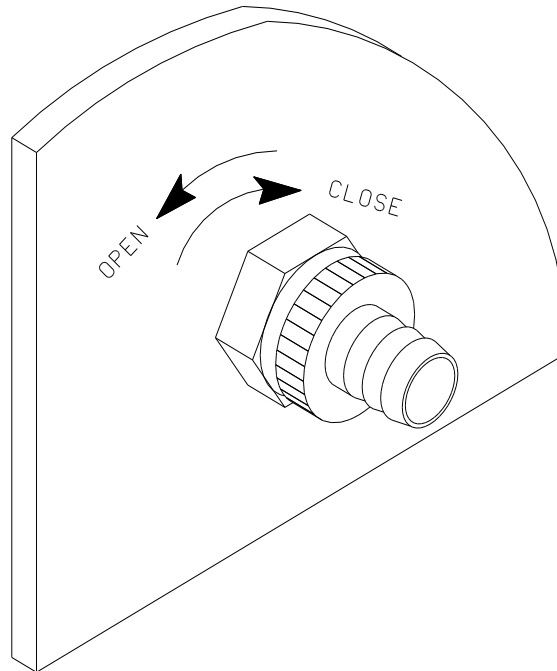

## 12.4 Cleaning water strainer



### Caution!

**Before proceeding, Make sure that the electric cord is disconnected and there is no pressure in the autoclave.**

1. Open the strainer cover (see the rear view).
2. Remove the strainer element.
3. Rinse the strainer with water. Use a brush if necessary.
4. Reinstall the strainer element.
5. Close the strainer cover.



### Caution!

**Do not touch the strainer's cover, mounted on the exhaust line, during and short after operation.**

**Touching the hot strainer's cover may cause severe injuries.**

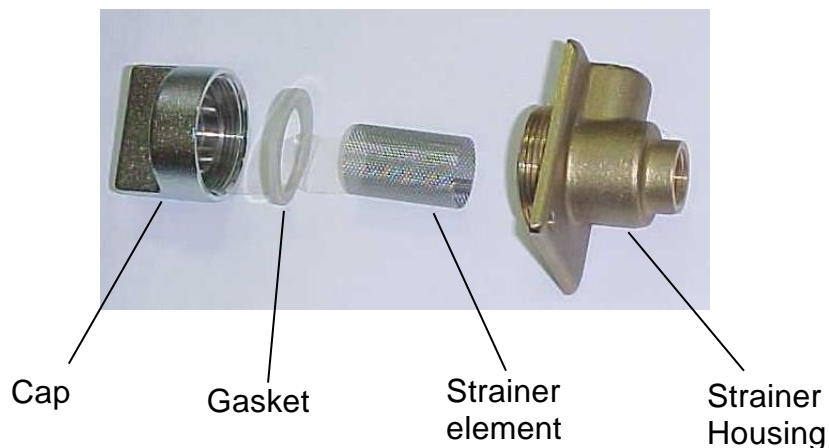

## 12.5 Checking the Safety Valve

(Located in the water reservoir, see the front view)

In order to prevent the safety valve from becoming blocked, it is necessary to allow the steam pressure to escape through it (every month).



### Caution!

**To avoid injuries begin this check while the autoclave is cold.**

### 12.5.1 ASME-approved type safety valve

1. Operate the sterilization cycle according to the manual.
2. Allow a pressure of approximately 200 kPa (29-psi) to build up in the chamber.
3. Remove water reservoir cover (1).
4. Pull the ring of the safety valve using a tool, i.e. screwdriver, hook etc and lift the safety valve ring (2) for 2 seconds.



### Attention:

**Use protective gloves in order not to burn your hands with the hot steam.**

5. Press the STOP key to abort operation, and allow the steam to exhaust from chamber.
6. Wait until pressure decreases to zero, only then the door can be opened.

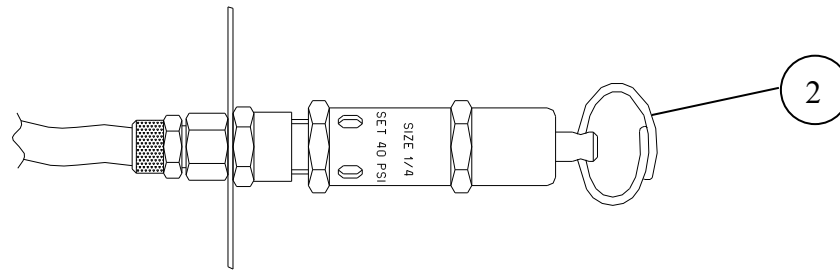

### 12.5.2 PED-approved type safety valve

1. Operate the sterilization cycle according to the manual.
2. Allow a pressure of approx. 200 kPa (29-psi) to build up in the chamber.
3. Remove the water reservoir cover.
4. Turn the pressure relief nut counterclockwise for 2 seconds. Verify steam escapes from the valve.



**Attention:**

**Use protective gloves in order not to burn your hands with the hot steam.**

5. Press the STOP key to interrupt the operation, and exhaust steam from the chamber.
6. Wait until the pressure decreases to zero, only then the door can be opened.

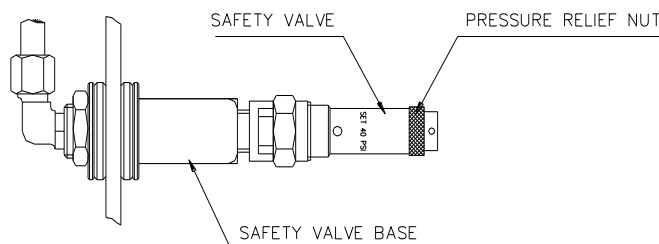

## 12.6 Cleaning the water sensor

It is required that the water sensor be cleaned at least once per week. Cleaning the sensor will ensure that the water level in the chamber is properly reported to the microprocessor all during the cycle.

The water sensor is located in the rear of the chamber. It is easily cleaned using a damp cloth or sponge, you may use a mild soapy solution if you like. It is important to wipe the sides of the sensor as well as the tip, to remove any dirt or debris that may have built up.



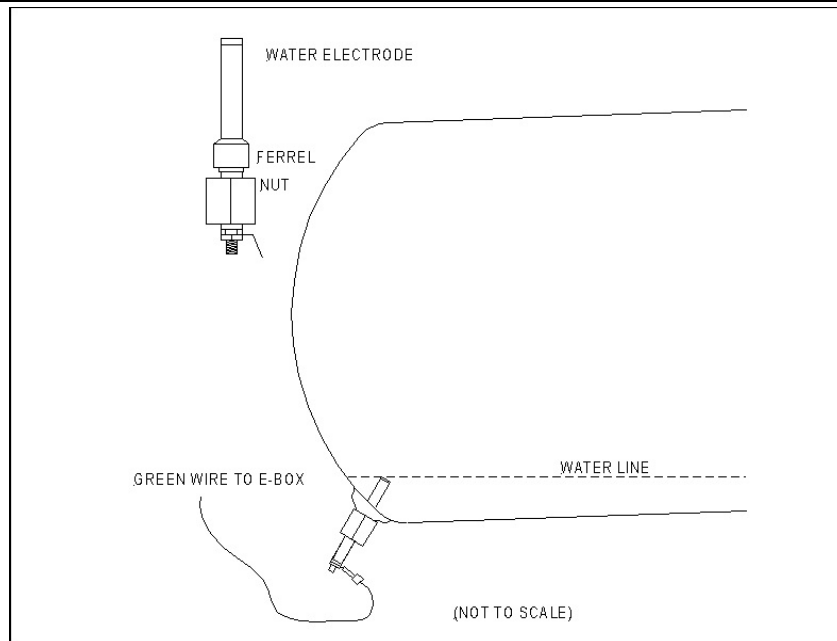

## 12.7 Moving the Autoclave

1. Disconnect the power supply cord.
2. Disconnect the water and drain hoses.
3. Disconnect the compressed air hoses (if applicable).
4. Drain the water from the chamber.

**To avoid injuries, moving the autoclave should be done by using a forklift.**



### Caution!

**Before moving the autoclave, verify that the electrical, air and water connections have been disconnected, and there is no pressure in the chamber.**

**Do not drop this device!**

## 13. Troubleshooting

This troubleshooting chart enables the user to solve minor malfunctions, prior to contacting our service department.

Only technical personnel having proper qualifications and holding technical documentation (including a technician manual) and adequate information are authorized to service the apparatus.

Message / Symbol / Problem	Failure Description	Corrective Action
The machine is not responding	<ol style="list-style-type: none"> <li>1 The main switch is in 'OFF' position.</li> <li>2 The power cord is disconnected from the machine or the mains.</li> <li>3 The circuit breaker has tripped.</li> </ol>	<ol style="list-style-type: none"> <li>1 Turn the main switch to the 'On' position. (see front view drawing).</li> <li>2 Make sure the power cord is connected properly to the machine and the mains. (see rear view drawing)</li> <li>3 Lift the circuit breaker lever.</li> </ol>
The printer prints, but nothing is printed on the paper.	<ol style="list-style-type: none"> <li>1 The Paper roll is not installed in the right way. (see sec. 8.2, Printer handling)</li> </ol>	<ol style="list-style-type: none"> <li>1 Install the paper roll in the right way. Only one side of the paper is printable. (see sec. 8.2, Printer handling)</li> </ol>
The printer does not print.	<ol style="list-style-type: none"> <li>1 No paper is inserted in the printer. (see sec. 8.2, Printer handling)</li> <li>2 No obvious reason.</li> </ol>	<ol style="list-style-type: none"> <li>1 Make sure the paper roll is inserted in the printer. (see sec. 8.2, Printer handling)</li> <li>2 Switch off the machine and switch it back on for restart</li> </ol>
Low Vacuum' is displayed	Message is displayed and FAIL indicator lights if in the air removal stage a vacuum	Perform a new cycle. Call for service.

Message / Symbol / Problem	Failure Description	Corrective Action
	level of 25kPa is not reached during 20 minutes after the cycle is started.	
The machine is leaking at the door	<p>1 The door gasket is dirty. (see sec. 12.1.1, daily maintenance)</p> <p>2 The door gasket is damaged.</p>	<p>1 Clean the door gasket. (see sec. 12.1.1, daily maintenance).</p> <p>2 Call for service.</p>
Low Vacuum' is displayed	Message is displayed and FAIL indicator lights if in the air removal stage a vacuum level of 15kPa is not reached during 20minutes after the cycle is started	<p>1 Perform a new cycle.</p> <p>2 Call the technician.</p> <p>3 The bio-hazard filter may be clogged. Since the door cannot be opened until a complete successful cycle is completed – call for technical service.</p>
Analog Input Error	This message is displayed when any Temperature sensor or Pressure sensor is disconnected or out of range.	Call for service.
Chamber temperature not in range	This message is displayed if the temperature in the chamber is too high or too low from the normal range.	Call for service.
Chamber pressure not in range	This message is displayed if the pressure in the chamber is too high or too low from the normal range.	Call for service.
I/O Card Failed	This message is displayed if I/O card is faulty (both while cycle is running or not).	Call for service.
I/O card is not connected	This message is displayed if I/O card is disconnected (both while cycle is running or not).	Call for service.
Low Temp	This message is displayed if the temperature drops for more	Perform a new cycle.

Message / Symbol / Problem	Failure Description	Corrective Action
	than 1 second below the sterilization temperature during sterilization cycle.	
High Temp	This message is displayed if the temperature raises 7°F (4°C) above sterilization temperature during the sterilization stage for 2 seconds during sterilization cycle.	Perform a new cycle.
High Temp. (Ending)	This message is displayed if the system cannot reach the required temperature, in the chamber, within 10 minutes.	Perform a new cycle.
Heat Time Error	This message is displayed if the system cannot reach the required temperature, in the chamber, within the preset time.	Verify that the autoclave is not overloaded.
Heat Time Error (Keep)	This message is displayed if the system cannot reach the required temperature, in the chamber, during the optional "Keep Heat" stage, within the preset time.	Verify that the autoclave is not overloaded.
Low Pressure	This message is displayed if Chamber Pressure drops below the sterilization pressure (134°C = 304 kPa, 121°C = 205 kPa) for 2 seconds during the sterilization stage.	Perform a new cycle.
High Pressure	This message is displayed if Chamber Pressure raises 4.2 psi-29 kPa above sterilization pressure (134°C = 304 kPa, 121°C = 205 kPa) for 2 seconds during the sterilization stage.	Perform a new cycle.
High Pressure (Ending)	This message is displayed if the system cannot reach atmospheric pressure $\pm$ 5kPa	Perform a new cycle.

Message / Symbol / Problem	Failure Description	Corrective Action
	during the ending stage.	
High Pressure (Exhaust)	This message is displayed if the system cannot reach preset pressure within 10 minutes from the beginning of the exhaust stage.	Perform a new cycle.
Pressure Time Error	This message is displayed if the system cannot reach the required pressure conditions in the chamber, after preset time, during the air removal stage.	Verify that the autoclave is not overloaded.
RTC Error - Please Set Current Date and Time	This message is displayed in order to set the date and the time.	Set Current Date And Time. If the problem persists, call the technician.
Time Error	This message is displayed if the real time clock is faulty.	Call the technician.
Door is open (During the cycle)	This message is displayed when the door is open: During the cycle.	Close the door to perform a new cycle.
Canceled By User	This message is displayed after the START/STOP key is pressed and cycle aborted.	Wait until "cycle failed – canceled by user" or "cycle end – canceled by user" is displayed. Perform a new cycle.
Cycle Failed 	This message and symbol are displayed if an error occurs before sterilization cycle is completed.	Perform a new cycle.
Air Error	This message is displayed at the end of the cycle if the autoclave does not reach the atmospheric pressure after 10 minutes.	Wait until the autoclave reaches the atmospheric pressure and perform a new cycle.
Compressed air supply error	This message is displayed in case of a compressed air supply malfunction.	Check and fix the compressed air supply.
Periodical	The periodical maintenance	Call for service.

<b>Message / Symbol / Problem</b>	<b>Failure Description</b>	<b>Corrective Action</b>
check time exceeded - Please call for service	time has passed.	
Cycle counter exceeded - Please call for service	Number of cycles, since last periodical maintenance, exceeded the preset number as defined by "cycle counter" parameter.	Call for service.
Power Down	This message is displayed if power down has occurred during the cycle. (this message will print out in the printer after the autoclave will turn on).	Turn on the autoclave and wait until the autoclave is ready (reaches the safe condition) and perform a new cycle.
Supply distilled water error (digitat input option)	This message is displayed in case of a mineral free water supply malfunction.	Check and fix the mineral free water supply
Supply water error (digitat input option)	This message is displayed in case of a city (tap) water supply malfunction.	Check and fix the city (tap) water supply.
Compressed air supply error (digitat input option)	This message is displayed in case of a compressed air supply malfunction.	Check and fix the air supply.
No Water	This message is displayed if the electrode in the chamber did not sense water within the preset time.	<ol style="list-style-type: none"> <li>1. check and fix the mineral free water supply.</li> <li>2. check and clean the water inlet filter.</li> <li>3. Clean the water level electrode.</li> </ol>

## 14. Baskets and Containers



Basket

Container for waste products

Type	Stainless steel wire baskets		Stainless steel container for waste products	
Model	L x D x H (mm)	Capacity	L x D x H (mm)	Capacity
3840	400x260x225	1	400x260x225	1
3850	500x260x225	1	500x260x225	1
3870	680x260x225	1	680x260x225	1

## 15. Spare Parts List

---

Description	Cat. No.
Strainer element, 400µ	FIL175-0046
Cap for 1/4" strainer	FIL175-0027
Teflon gasket 4mm	GAS082-0008

## 16. Accessories List

---

Description	Cat. No.		
	3840	3850	3870
Pouch rack (available upon request)			ACS215-0008
Printer paper	THE002-0052	THE002-0052	THE002-0052
Tray	TY304-0001	TRY-385-0005	TRY387-0005
Basket	BSK304-0003	BSK385-0002	BSK387-0006
Container (available upon request)	BSK304-0004	BSK385-0001	BSK387-0004