

ALL DAY SLEEPER

ARTHUR



**AMERICAN
LEATHER**

ARTHUR

Standard Features:

- Advanced unidirectional suspension system
- Premium high-density, high-resiliency foam seat cushions
- Loose back cushions
- Semi-attached seat cushions
- Single-needle top-stitch
- Limited lifetime warranty on frame and suspension
- Three-year warranty on mechanism
- Quick-ship delivery

Options:

- Premium high-density, high-resiliency foam bench seat cushion
- Premium high-density, high-resiliency foam bench seat cushion with memory foam encased in down (Back section of sofa is constructed of fiber, even when seat cushions are ordered in down)
- Premium high-density, high-resiliency foam seat cushions with memory foam encased in down (Back section of sofa is constructed of fiber, even when seat cushions are ordered in down)
- Loose down-filled back cushions
- Low leg available with black plastic leg
- High leg available with wood leg in Dune, Ebony, Mink, or Oiled Ash finish

Please use actual leather, fabric, Crypton®, Sunbrella® and Ultrasuede® swatches when specifying furniture as the colors shown may vary due to the printing process.

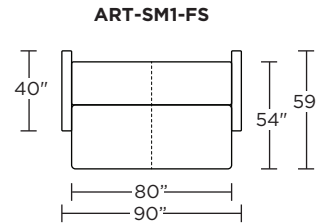
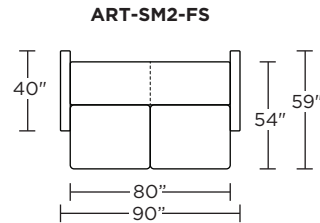
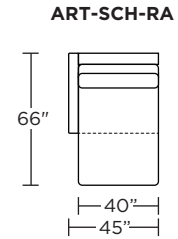
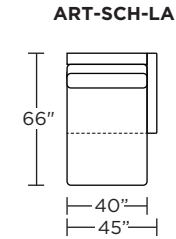
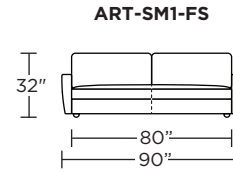
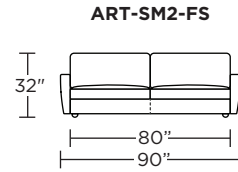

STORAGE CHAISE:

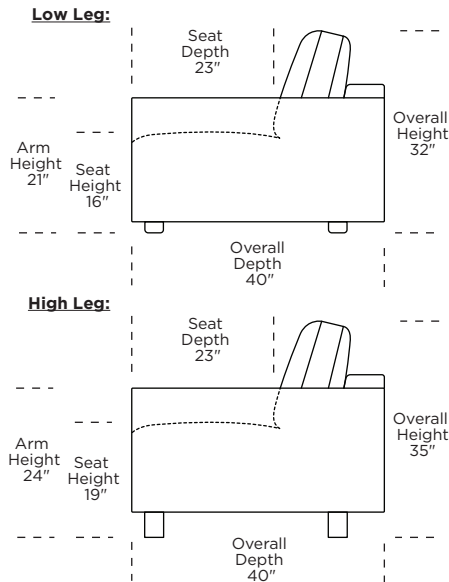
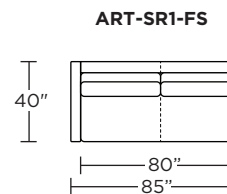
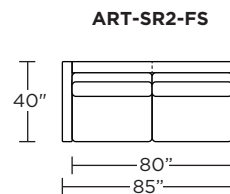
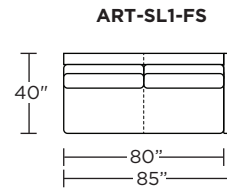
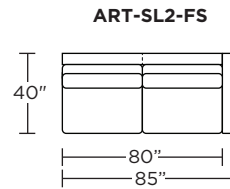
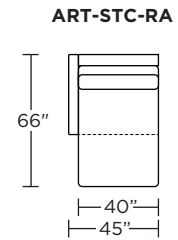
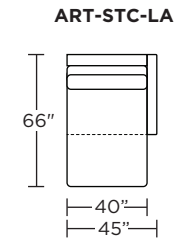

Note: Dotted line indicates seam on leather, Ultrasuede® and up the roll fabrics. Seams are eliminated with railroaded fabrics.

Scale: 1/4 inch = 1 foot
All dimensions are approximate and subject to change.
Specify components from the sitting position.