

KICKASS[®]

**12/240V
RECHARGEABLE
WET/DRY
VACUUM SEALER**



QUICK START GUIDE

KAVS12240V-LION

V0.5

INTRODUCTION

Keeping food fresh can be challenging while you are out camping or off the beaten track. With the all new KickAss 12v Vacuum Sealer, you can do just that!

Now with a rechargeable lithium-ion battery with both 12v and 240v capabilities, you can prep your food at home or out on the road!

Sealing your food at home is great for packing, saving room in your fridge or esky and eliminating the need of bulky containers.

The 12v connection of the KickAss Vacuum Sealer means you can also use and charge your sealer while you are travelling, perfect for storing leftovers or fresh caught fish and game meats.

The KickAss Vacuum Sealer has settings for wet and dry foods, perfect for pre-marinated meats or foods with a higher moisture content.

The new KickAss Vacuum Sealer is a vital part of any camping kitchen to help keep your food fresh while on the road.



FUNCTIONS AND FEATURES

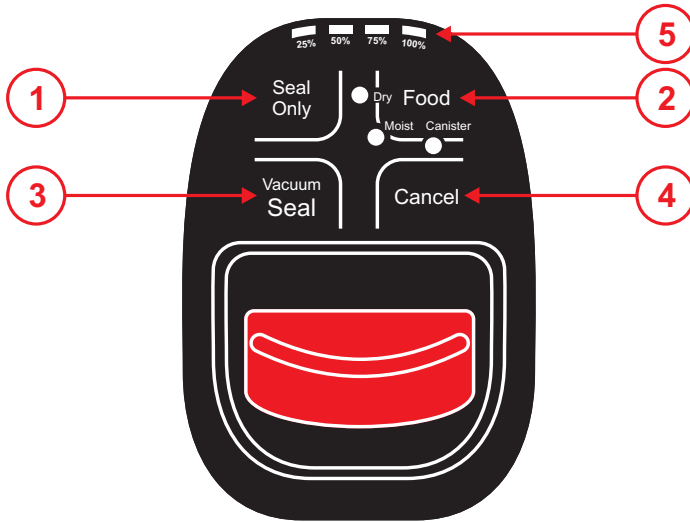

1 Seal Only

Heat seals the bag without engaging the vacuuming function. This mode can be used to make a bag from a bag roll.

2 Food: Dry/Wet/Container Setting

Dry: This mode is suitable for large bag vacuuming and products which have a low moisture content.

Moist: This mode is suitable for products that have a high moisture content.

Canister: This mode is suitable for use with vacuum containers.

3 Vacuum Seal

This mode will engage the vacuum function and heat seal the bag on completion.

4 Cancel

Stops the current vacuum operation.

5 Battery Charge Indicator

Displays the remaining charge of the battery.

SPECIFICATIONS DIAGRAM

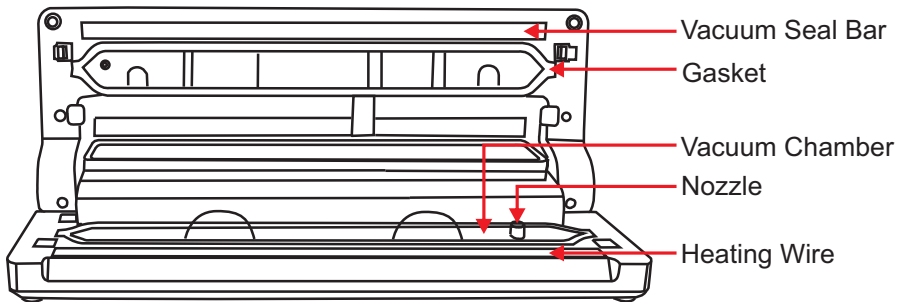
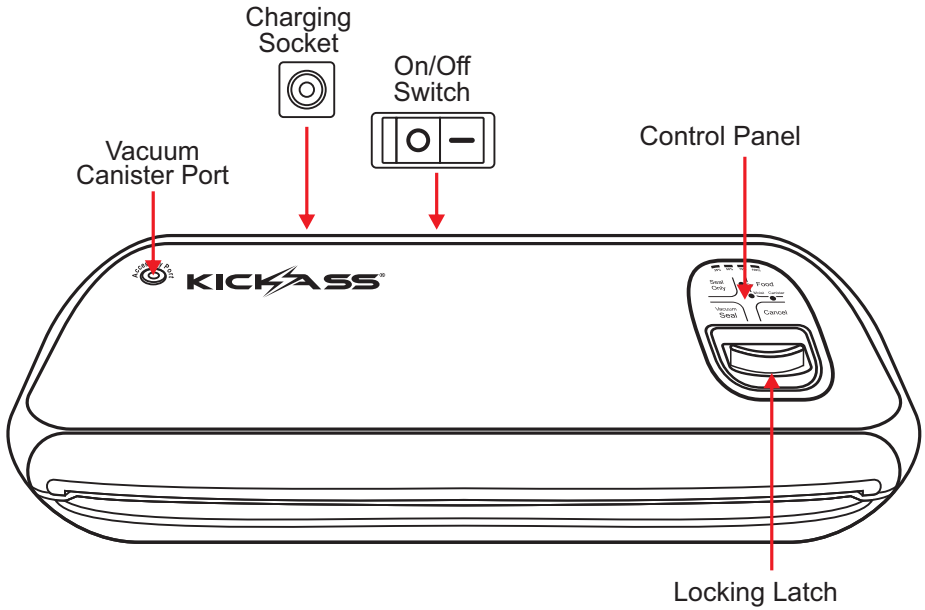

OPERATING INSTRUCTIONS

Step 1

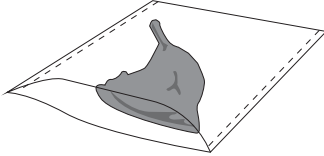

Take your desired size of plastic bag off the roll and use the Seal Only function to create a bag. Alternatively, use a pre-made bag. Place items into your bag. Make sure you leave some distance around the items.

Step 2

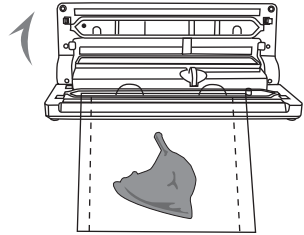

Open the top cover of the food sealer, place the bag with the items inside into the vacuum chamber but before the vacuum nozzle.

Step 3

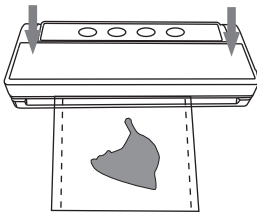

Close the top cover engaging the lock. Then press food mode. Then you will need to choose either Wet Mode or Dry Mode. When ready, press the Vacuum Seal button and the operation will begin.

Step 4

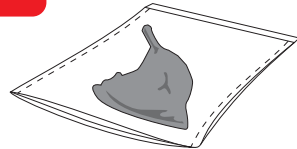

After the indicator light goes out and the machine stops, open the cover by pressing in the lock button on both ends of the cover and take your vacuum sealed item.



How To Seal With Vacuum Canister

1. Place item in vacuum canister.
2. Connect the canister to the vacuum tube and ensure both ends of the of vacuum tube are secure.
3. Press the Vacuum Seal Button and observe the vacuum indicator of the canister. When the canister indicates a vacuum, press the cancel button on the machine.
4. Gently pull out the vacuum tube.
Caution: Do not over vacuum.



- This appliance is not intended for use by persons (including children) with reduced physical sensory or mental capabilities, or lack of experience and knowledge, unless they have been given supervision or instruction concerning use of the appliance by a person responsible for their safety.
- Children should be supervised to ensure that they do not play with the appliance.

TECHNICAL SPECIFICATIONS

Model	KAVS12240V-LION
Products Size	356mm*141*68mm
Battery	14.8V 1500mAh
Motor rated voltage	DC 12V
Battery Run Time	Approx. 50 Seals
Material	ABS
Vacuum Pressure	75Kpa
Sealing Length	28cm
Sealing Width	2mm
Charger	12V-240V,50/60Hz
Battery charge time	~1.5h
Certification	CE/ROHS/FCC  
Country of Origin	China

WARRANTY

Warranty Period:

KickAss Products Pty Ltd (KickAss) of 2 Mallet Street, Kunda Park QLD 4556 offers a 12 month warranty from date of purchase against manufacturing defects in KickAss Products.

Warranty Inclusions:

Under ordinary usage conditions, this warranty covers any defect in design or manufacture which results in our product failing to perform substantially as described in our advertising or literature (i.e. product manuals).

Where we are at fault during the warranty period, we will either repair or replace the product (or part of the product) at our discretion. When a product is repaired or replaced under this warranty, the original warranty period is not renewed or extended.

This warranty is provided in addition to your other rights and remedies under the Australian Consumer Law and does not exclude, restrict, modify, limit or override your rights under the Australian Consumer Law.

How to Claim:

To make a claim visit supportportal.kickassproducts.com.au, email sales@kickassproducts.com.au. Please provide your proof of purchase (i.e. sales receipt) to assist with your warranty claim.

Once we approve your warranty claim, we will arrange (at our cost) return shipping of the faulty product to an assessment facility of our choice. Once we have determined the cause of the defect, we will contact you with the outcome of our assessment and advise whether the faulty product will be repaired or replaced.

Australian Consumer Law:

Our goods come with guarantees that cannot be excluded under the Australian Consumer Law. You are entitled to a replacement or refund for a major failure and compensation for any other reasonably foreseeable loss or damage. You are also entitled to have the goods repaired or replaced if the goods fail to be of acceptable quality and the failure does not amount to a major failure.

Warranty Exclusions:

Our warranty is non-transferable and is only offered to the original purchaser of our product.

Our warranty does not apply to:

1. Damage caused by any improper use of our product(s);
2. Damage caused by faulty installation or modification made during installation;
3. Damage caused by mould, insects, animals, misuse, incorrect operation, adverse weather, accidents and fair wear and tear;
4. Damage caused by exposure to excessive sunlight;
5. Costs, losses or charges:
 - of removing and reinstalling the product;
 - directly or indirectly associated with the product failing to operate.
6. Commercial use of KickAss Products by government organisations or commercial fleet applications;
7. KickAss Products that are on-sold by the customer or exported for use outside of Australia.

KICK  **ASS**®

kickassproducts.com.au