

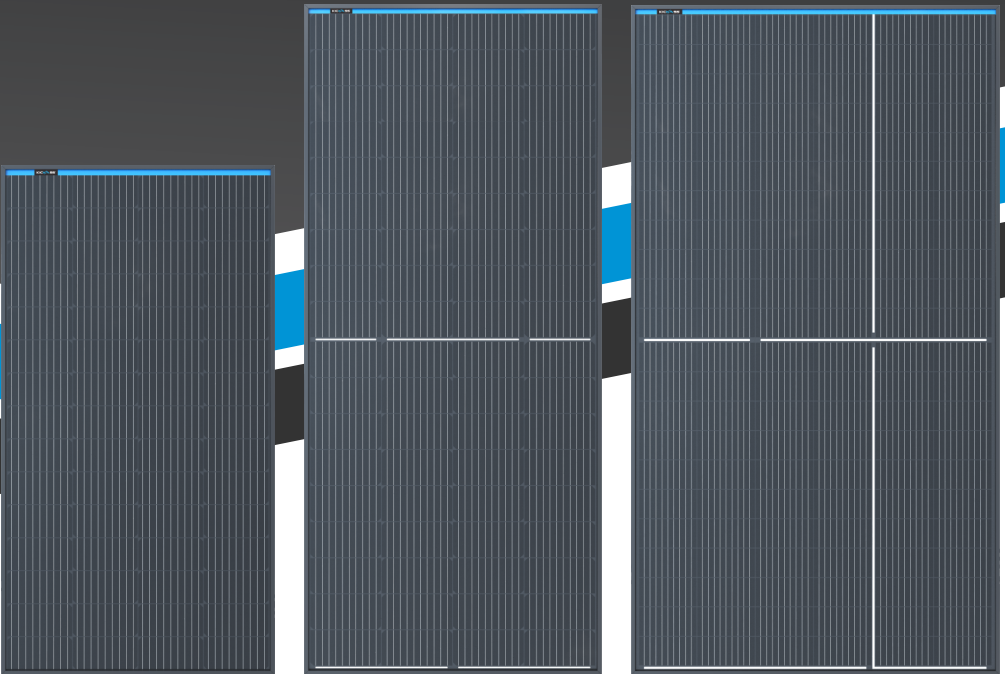

**POWER YOUR ADVENTURE**

**MONOCRYSTALLINE  
FIXED GLASS  
SOLAR PANEL  
USER MANUAL**



**KARTSP170 | KARTSP250 | KARTSP350**

# TABLE OF CONTENTS

<b>IMPORTANT WARNING AND SAFETY INSTRUCTIONS .....</b>	<b>1</b>
<b>SOLAR PANEL FEATURES .....</b>	<b>3</b>
<b>DIMENSIONS / SPECIFICATIONS .....</b>	<b>4</b>
<b>SOLAR POSITION OPTIMISATION GUIDE .....</b>	<b>7</b>
<b>INSTALLATION GUIDE .....</b>	<b>8</b>
<b>RECOMMENDED CONFIGURATION .....</b>	<b>9</b>
<b>RECOMMENDED CONNECTION DIAGRAM .....</b>	<b>12</b>
<b>AVAILABLE ACCESSORIES .....</b>	<b>11</b>
<b>BRACKET ASSEMBLY GUIDE .....</b>	<b>12</b>
<b>ROOF RACK MOUNTING GUIDE .....</b>	<b>13</b>
<b>FLAT ROOF MOUNTING GUIDE .....</b>	<b>15</b>

## **IMPORTANT WARNING AND SAFETY INSTRUCTIONS**

### **PLEASE SAVE THESE INSTRUCTION. THIS MANUAL CONTAINS IMPORTANT SAFETY INSTRUCTIONS FOR THE KICKASS FIXED GLASS SOLAR PANELS.**

Do not operate Solar Panels unless you have read and understood this manual and the Solar Panel has been installed as per the instructions detailed in the manual.

### **WARNING - RISK OF EXPLOSIVE GASES**

Working in the vicinity of Lead-Acid batteries is dangerous. During normal operation batteries generate explosive gases. It is important that the battery is operated in a well-ventilated area and the Solar Panel is installed as per the instructions detailed in the manual.

### **WARNING**

Check the battery manufactures guide for the recommended voltage profile for charging. Failure to ensure the selected voltage does not exceed the recommend profile could damage your battery. Change the selection if necessary before charging the battery.

### **WARNING! RISK OF INJURY AND DAMAGE DUE TO INCORRECT INSTALLATION OR SECURING OF PRODUCT**

It is highly important to correctly secure your Solar Panel in the event of high wind. The instructions provided in this manual are a guide and it is the responsibility of the user to ensure the product is securely attached to a mounting surface at all times in accordance with all local and national safety standards. In addition, any mounting devices used for installation must adhere to the manufacturer's safety instructions and it may be required to exceed these, to comply with local and national standards. We recommend that a qualified installer be used.

## CAUTION!

- This appliance is not intended for use by persons (including children) with reduced physical, sensory or mental capabilities, or lack of experience and knowledge, unless they are supervised or have been properly instructed on how to use the appliance by a person responsible of their safety. Children should be supervised to ensure they do not play with the appliance.
- Do NOT connect the Solar Panels directly to a battery. Always use a solar regulator of the correct input rating to connect the Solar Panels before connecting and charging the battery.
- Ensure to use the Solar Panel with a regulator of the correct input rating and suitable charge profile for the battery chemistry type being charged.
- The battery should be mounted in a well ventilated area, and a safe distance from any ignition source. Never smoke or allow a spark or flame in the vicinity of the battery. This may cause the battery to explode.
- To reduce the risk of sparks, connect or disconnect the Solar Panel to the charge regulator before exposure to sunlight. The Solar Panels may generate voltage up to the rated open circuit voltage value at the connection leads while unconnected.
- The Solar Panel will achieve best results when proper battery maintenance is regularly performed.
- Do not use mirrors or other devices to artificially concentrate sunlight on the Solar Panel.
- All panels used in series, parallel, or series-parallel is suggested to be the same model. Check the manufacturer data for the regulator and you select and ensure that open circuit voltage does not exceed the recommended maximum charging voltage and the cable you select can handle the high current and voltage.
- Partially shaded or partially obscured Solar Panel will have a reduced output, and can potentially damage the Solar Panel over time.

## PERSONAL SAFETY PRECAUTIONS

When connecting the Solar Panel to batteries via the regulator:

- Wear complete eye and clothing protection.
- Avoid touching eyes while working near a battery.
- If battery acid contacts your skin or clothing, remove the affected clothing and wash the affected area of your skin immediately with soap and water. If battery acid enters your eye, immediately flood the eye with running cold water for at least 10 minutes and seek medical assistance immediately.



KARTSP170



KARTSP250



KARTSP350

**SCAN TO VISIT THIS PRODUCT'S LANDING PAGE**

# FEATURES

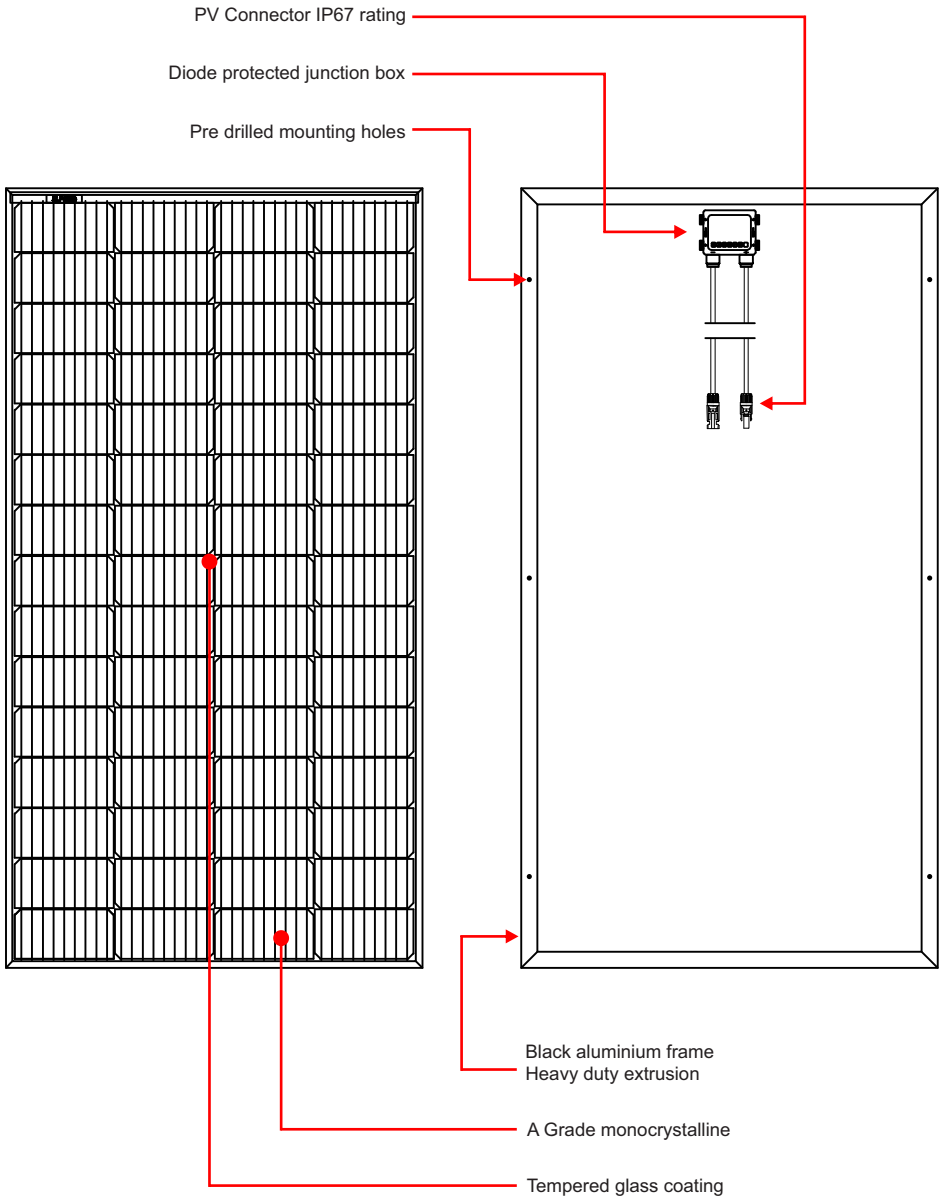

# DIMENSIONS / SPECIFICATIONS

## KARTS170

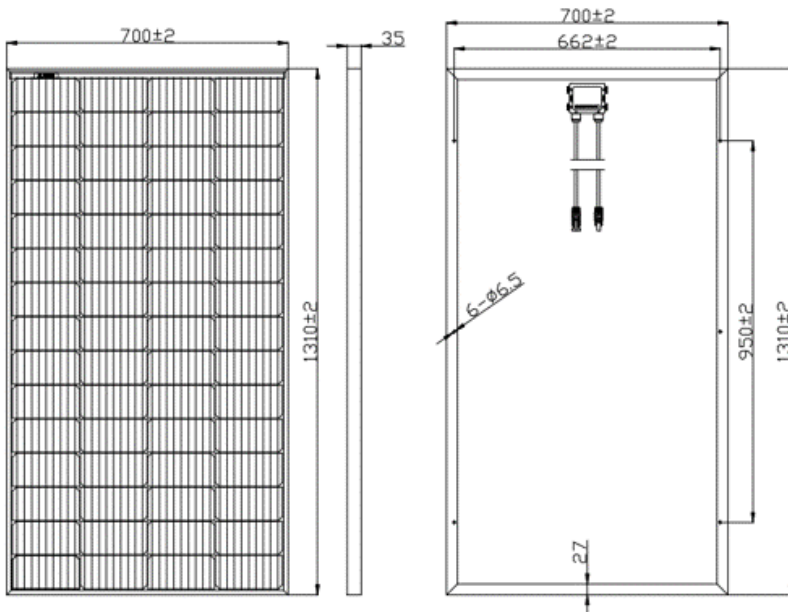

## SPECIFICATIONS

SKU:	KARTSP170	Application class:	Class A
Cell type:	High efficiency A-grade monocrystalline	Fire safety class:	Class C
Max power (Pmax):	170W	Maximum system voltage:	1000VDC
Max power voltage (Vmp):	18.46V	Operating temperature:	-40°C to 85°C
Max power current (Imp):	9.2A	Nominal operating cell temperature:	47 °C
Open circuit voltage (Voc):	21.66V	Connector type:	Water proof PV Connector
Short circuit current (Isc):	10.06A	Standard test condition:	1000W/m <sup>2</sup> AM1.5 25°
Dimensions:	1315mm x 690mm x 35mm	Power tolerance:	+ / - 5%
Weight:	10.2kg	Dimension tolerance:	+ / - 2mm
Frame:	Black powder coated aluminium	Conversion efficiency:	20.6%

# KARTS250

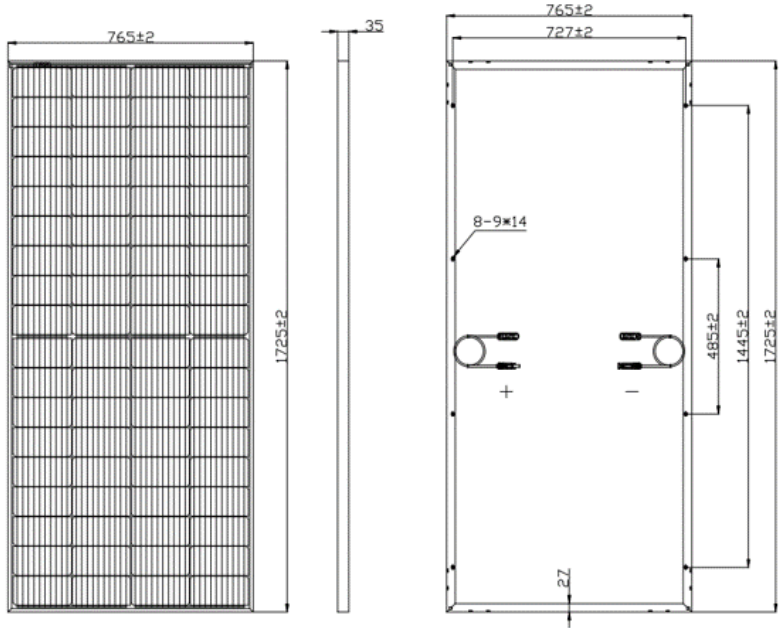

## SPECIFICATIONS

SKU:	KARTSP250	Application class:	Class A
Cell type:	High efficiency A-grade monocrystalline	Fire safety class:	Class C
Max power (Pmax):	250W	Maximum system voltage:	1000VDC
Max power voltage (Vmp):	20.69V	Operating temperature:	-40°C to 85°C
Max power current (Imp):	12.37A	Nominal operating cell temperature:	47 °C
Open circuit voltage (Voc):	24.86V	Connector type:	Water proof PV Connector
Short circuit current (Isc):	13.06A	Standard test condition:	1000W/m <sup>2</sup> AM1.5 25°
Dimensions:	1725mm x 765mm x 35mm	Power tolerance:	+ / - 5%
Weight:	13.80kg	Dimension tolerance:	+ / - 2mm
Frame:	Black powder coated aluminium	Conversion efficiency:	20.6%

# KARTS350

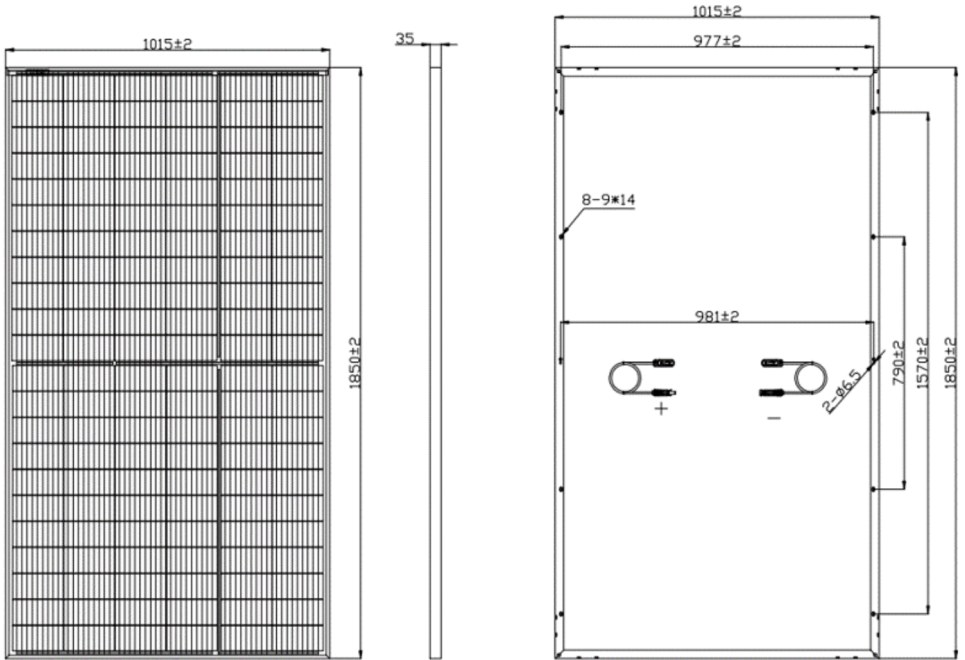

## SPECIFICATIONS

SKU:	KARTSP350	Application class:	Class A
Cell type:	High efficiency A-grade monocrystalline	Fire safety class:	Class C
Max power (Pmax):	350W	Maximum system voltage:	1000VDC
Max power voltage (Vmp):	19.01V	Operating temperature:	-40°C to 85°C
Max power current (Imp):	18.52A	Nominal operating cell temperature:	47 °C
Open circuit voltage (Voc):	22.24V	Connector type:	Water proof PV Connector
Short circuit current (Isc):	19.96A	Standard test condition:	1000W/m <sup>2</sup> AM1.5 25°
Dimensions:	1850mm x 1015mm x 35mm	Power tolerance:	+ / - 5%
Weight:	20.1kg	Dimension tolerance:	+ / - 2mm
Frame:	Black powder coated aluminium	Conversion efficiency:	20.6%



# SOLAR POSITION OPTIMISATION GUIDE

Kickass Solar Panels will perform at their peak with the Panel face angled directly towards the sun. In the field this is not always possible. Kickass recommends angling the Panel between 20° and 40° from the ground. This ensure the most efficient total power output from your Solar Panel during the course of the day, in all seasons.

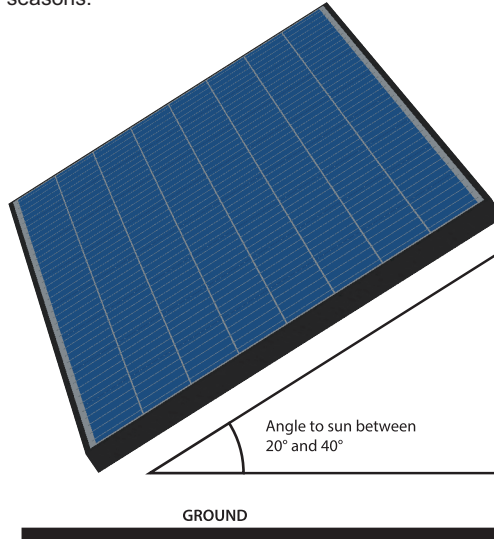

In the southern hemisphere, the sun is always in the NORTHERN half of the sky. Facing your Panel NORTH ensures the best angle to the sun for a Solar Panel during the course of the day. In the northern hemisphere, the sun is always in the SOUTHERN half of the sky. Facing your Panel SOUTH ensures the best angle to the sun for a Solar Panel during the course of the day.

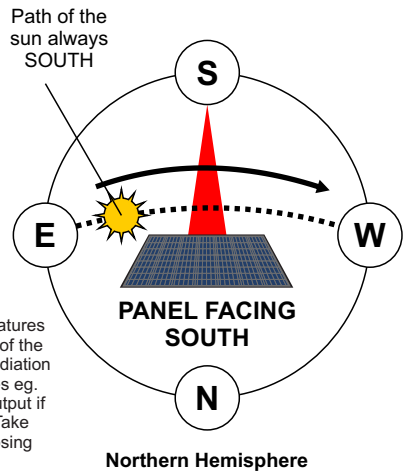
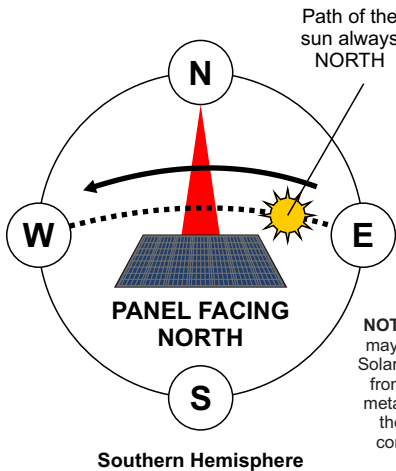

**NOTE:** High panel temperatures may reduce the efficiency of the Solar Panel output. Heat radiation from surrounding surfaces eg. metal, may cause lower output if there is limited air flow. Take consideration when choosing mounting surfaces.

# INSTALLATION GUIDE

When choosing installation positions for the Solar Panels, be aware of shading that can occur as a result of fixed existing accessories near to the panels.

Shading on sections of the Solar Panels will significantly reduce the output performance of the panels. To prevent this, take care to avoid the possibility of shading in the final installation position. During the installation process, care must be taken to ensure that the solar panels are not exposed to direct sunlight or are covered with an opaque material to prevent potentially dangerous voltages from inadvertently being generated.

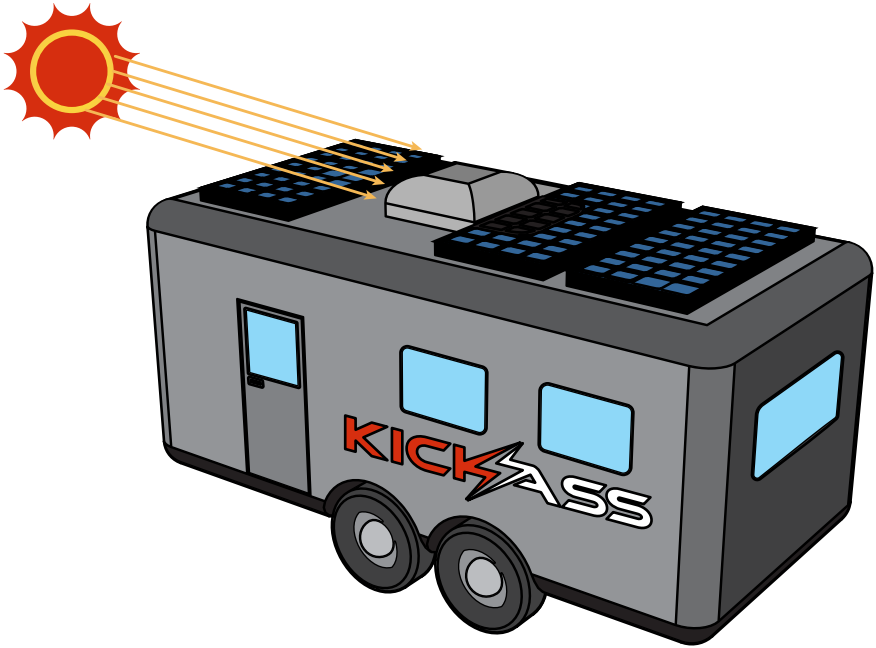

# RECOMMENDED CONNECTION DIAGRAM

KickAss Solar Panels can be connected in Parallel or Series as per the diagrams below, or a combination of the two. Connecting two identical panels (of the same wattage) in parallel will multiply the total output current by 2 and keep the system voltage at the same level. Conversely, connecting two identical panels (of the same wattage) in series will multiply the system voltage by 2 and keep the output current at the same level. Parallel connections should be made using PV branch connectors. Quality KickAss PV 2 in 1 branch connectors are available and can be purchased through the store. Series connections should be made by connecting the negative connector of one panel to the positive of the next.

Parallel connections

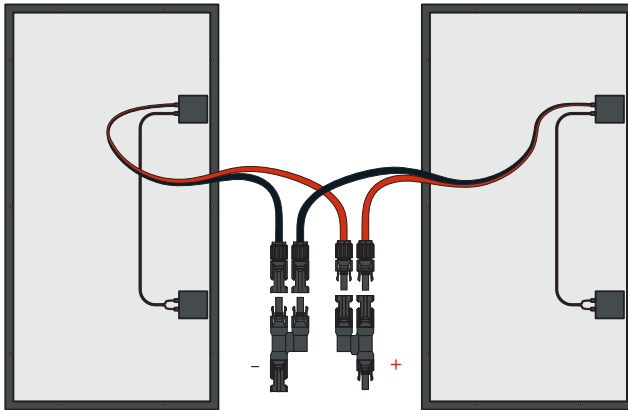

PV Connector 2 in 1 Branch  
SKU: KAPVCONN2IN1

Series connections

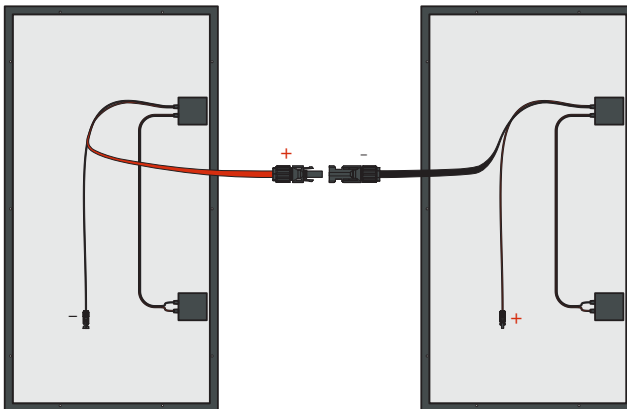

Parallel connections

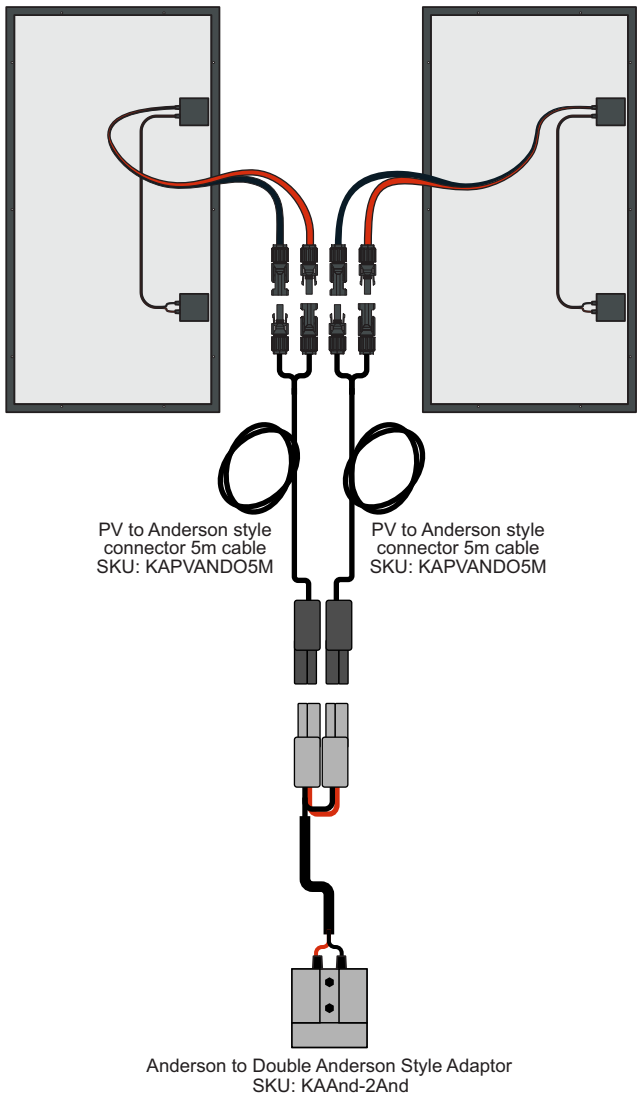

# AVAILABLE ACCESSORIES

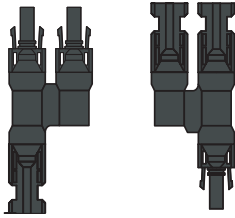

PV Connector 2 in 1 Branch  
SKU: KAPVCONN2IN1

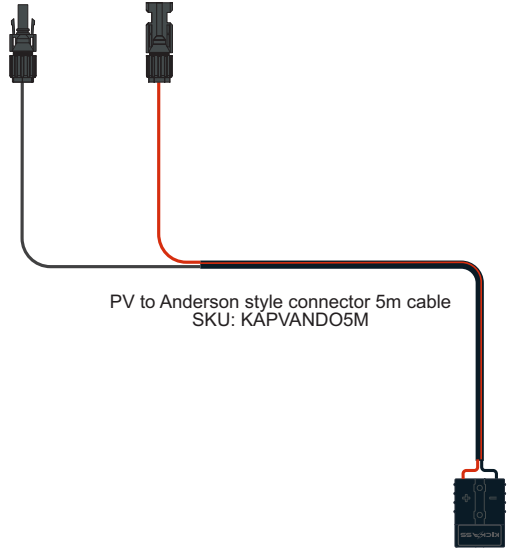

PV to Anderson style connector 5m cable  
SKU: KAPVANDO5M

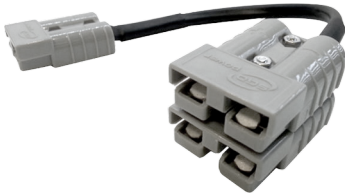

Anderson to Double Anderson Style Adaptor  
SKU: KAAnd-2And

Mounting Bracket x4

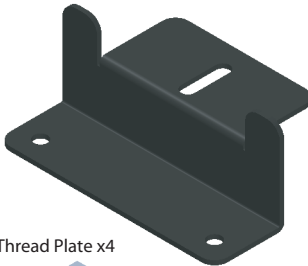

Thread Plate x4

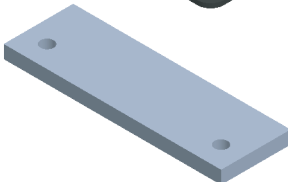

M6x16mm Machine Screw x4



M6x40mm Machine Screw x8



M6x40mm Self Tapper x8



M6 Spring Washer x12



M6 Plain Washer x12



M6 Nut x12



Solar Panel Mount Kit  
SKU: KASPBRKT

# BRACKET ASSEMBLY GUIDE

The optional solar panel mounting bracket kit has been designed as an all in-one solution for rack or surface mounting.

Mounting Bracket x4

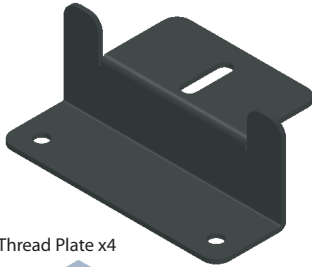

Thread Plate x4

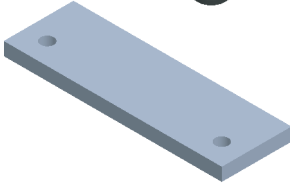

M6x16mm Machine Screw x4



M6x40mm Machine Screw x8



M6x40mm Self Tapper x8



M6 Spring Washer x12



M6 Plain Washer x12



M6 Nut x12



Solar Panel Mount Kit  
**SKU: KASPBRKT**

## Bracket Assembly to Solar Panel

### Step 1.

Locate pre-drilled holes in Solar Panel frame and secure all 4 mounting brackets.

Note: Before choosing assembling hole locations, check fitment area for the best position to align with mounting surfaces.

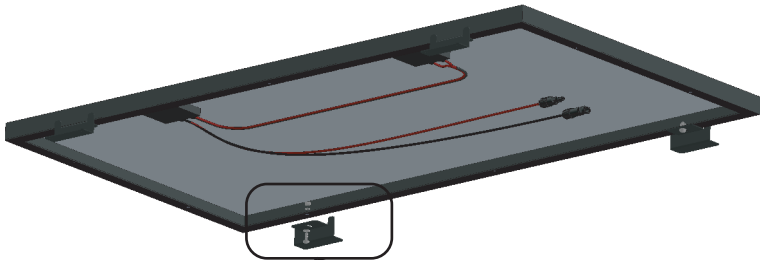

### Step 2.

Assemble mounting bracket to Solar Panel frame as shown using the following hardware:

M6x16mm Machine Screw x4

M6 Spring Washer x12

M6 Plain Washer x4

M6 Nut x12

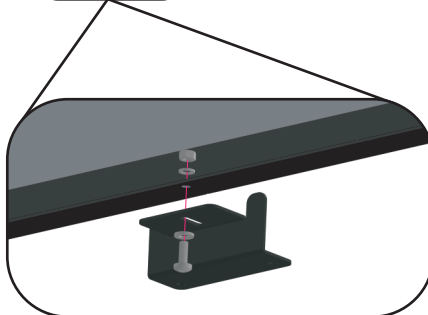

# ROOF RACK MOUNTING GUIDE

## **Step 1** - Locate Solar Panel on Roof Rack:

Consider the following when choosing location for the Solar Panel on the roof rack of your vehicle:

Alignment of mounting brackets with rack cross members so all 4 brackets are can be secured.

Cable routing - Keep all wiring away from sharp edges and secure with zip ties.

Shading from existing fixtures.

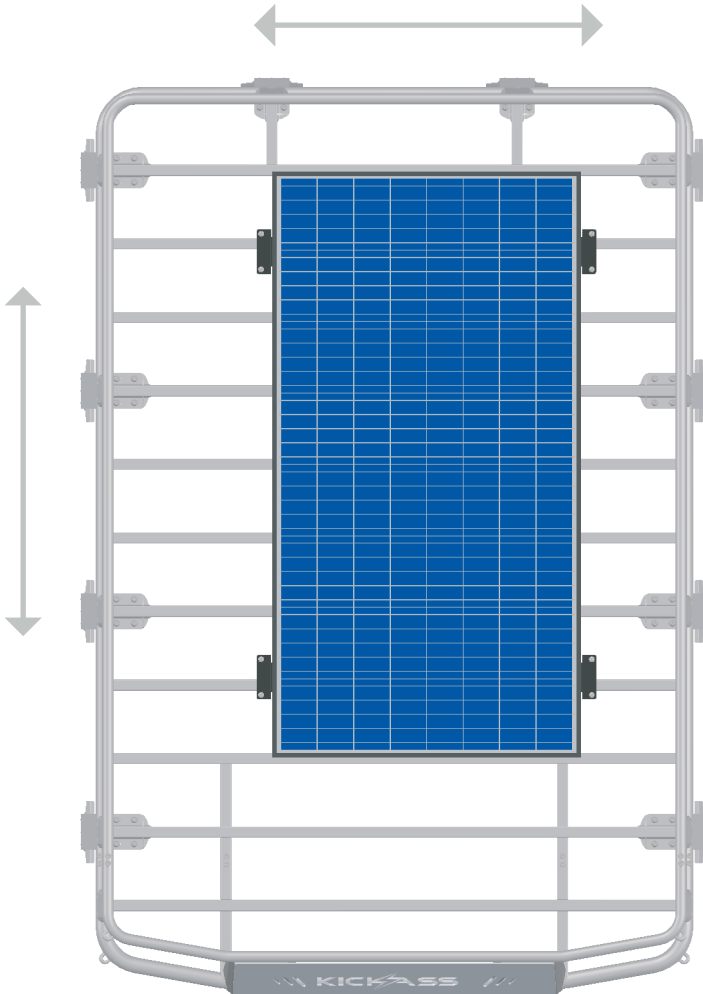

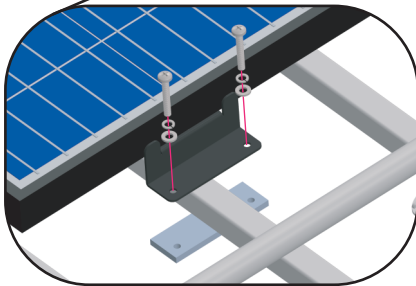
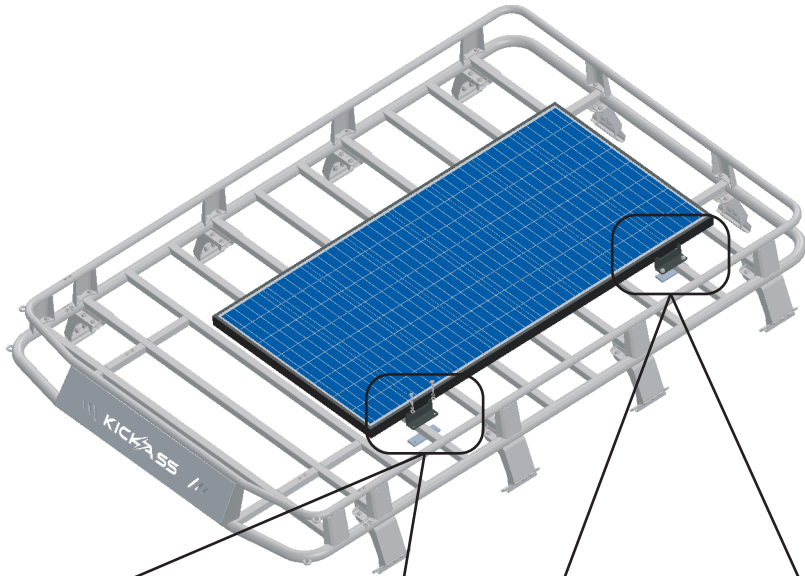

**Step 2.**

Secure mounting bracket by locating thread plate with brackets and fixing with M6x40 machine screws, flat and spring washer.

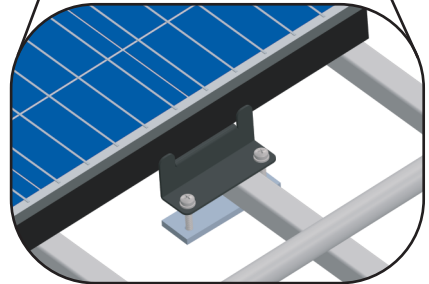

**Step 3.**

Fix M6 Nut to lock screws

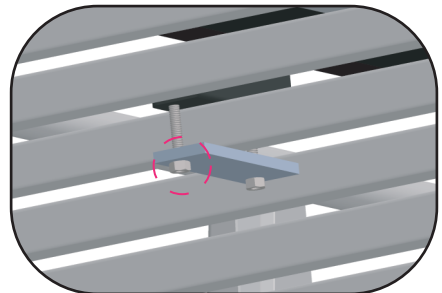



# FLAT ROOF MOUNTING GUIDE

## **Step 1** - Locate Solar Panel on Roof Surface:

Consider the following when choosing location for the Solar Panel on rack:

- Alignment of mounting brackets on a flat surface so all 4 brackets can be secured.
- Cable routing - Keep all wiring away from sharp edges and secure well.
- Shading from existing fixtures.

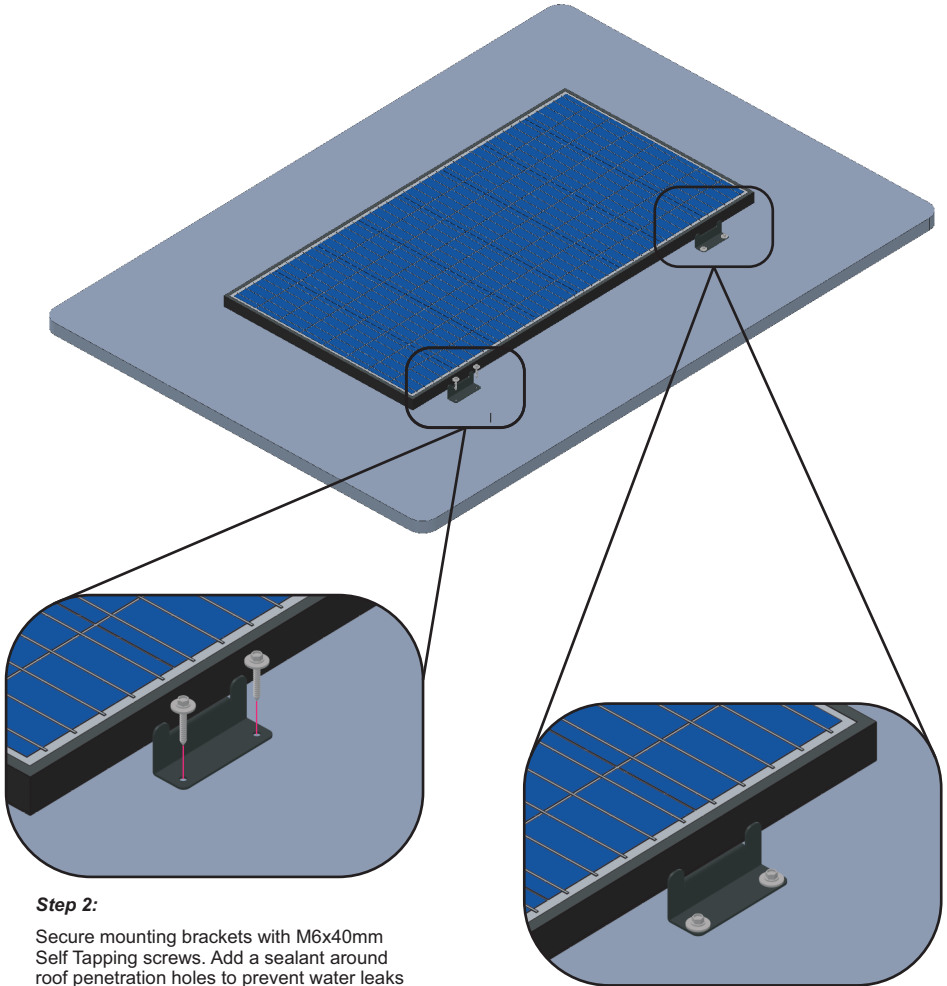

## **Step 2:**

Secure mounting brackets with M6x40mm Self Tapping screws. Add a sealant around roof penetration holes to prevent water leaks where appropriate.

THANK YOU FOR CHOOSING

**KICKASS**<sup>®</sup>



For more information please visit us at:  
**[kickassproducts.com.au](http://kickassproducts.com.au)**