

KICKASS[®]

7" LASER LED DRIVING LIGHTS

USER MANUAL



KADRVLIGHT-7

CONGRATULATIONS ON PURCHASING YOUR NEW KICKASS SIDE BLINDER LED SPOTLIGHTS

WHY KICKASS?

KickAss is focused on bringing the luxury of home to the outdoors. Your one stop shop for 12V products. All of our products are designed to be plug and play, for the ultimate camping experience.

IMPORTANT SAFETY FEATURES

- Any 12V installation work should be done by a professional, failing to do this may result in damage to your unit or vehicle.
- Ensure wiring is away from any moving parts.
- Do not cut or modify the wiring, doing so may void your warranty.
- Do not attempt to disassemble the spotlights, doing so may result in damage.
- It is the customers responsibility to ensure the unit is adequately mounted. Each light should be mounted with all three bolts and rubber pads.
- Ensure the waterproof connectors have a good connection before use.
- When installing a headlight adapter, ensure any headlight covers are replaced. Failing to do this may lead to a build up of moisture and dust within the headlight.
- Avoid overheating by ensuring the spotlights have adequate ventilation.
- The spotlights generate heat, ensure the spotlights are not left on for more than 15 minutes with the vehicle stationary.
- Do not stare directly into the light of the spotlights.
- Ensure the manual and warnings are understood.

OVERVIEW



2x KickAss Side Blinder Spotlights



6x Stainless Steel Mounting Bolts, Nuts and Washers



1x Pre Wired Plug and Play Heavy Duty Wiring Kit

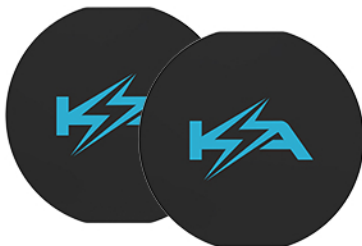

Light Covers



2x Anti-Theft Torx Head Allen Keys



2x Anti Vibration Mounting Pads



1x Warranty Card

SETTING UP YOUR SPOTLIGHTS

Note: Ensure you review and comply with local laws regarding spotlight mounting positions and directions

Note: Failing to use all three bolts and the Anti Vibration Rubber pad may void your warranty

1. Using the supplied anti-theft torx head allen keys, tighten the bolts connecting the light to the mounting bracket
2. Find a suitable place to mount your spotlights. Ensure the mounting location is sufficiently strong enough to support the spotlights. If mounting on a bullbar, ensure the spotlights are not restricting airflow to your vehicle's radiator and engine bay.
3. If drilling is required, mark the hole centers of three holes using the anti vibration mounting pad as a guide.
4. Drill three holes and ensure holes are deburred and coated to protect from corrosion
5. Insert the three mounting bolts into the spotlight bracket. Ensure the anti vibration mounting pad is placed between your spotlights and your mounting bracket.
6. Fit the spotlights to the mounting surface, ensuring the plain washer, and then the spring washer are placed onto the end of the bolt.
7. Tighten with a spanner or socket until the spring washer is completely compressed

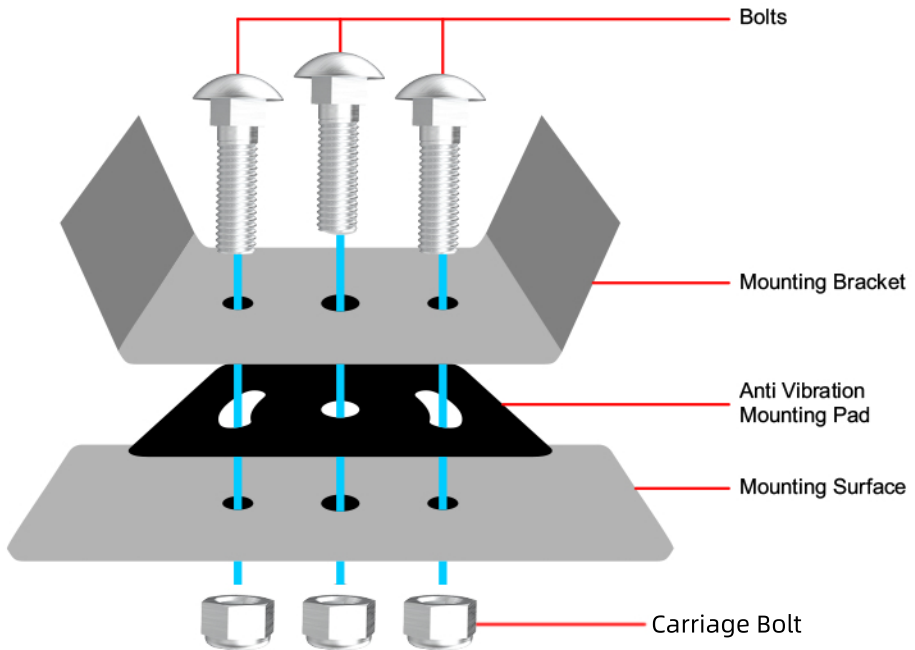

CONNECTING THE LIGHTS

Note: The spotlights have been supplied with an ADR compliant wiring harness however laws may change between localities. Ensure you check local laws regarding spotlight wiring.

Note: The wiring harness that has been supplied has been designed such that it can be connected to both positive and negatively switched headlights.

1. **General Note:** When performing any auto electrical work, always disconnect the negative terminal from your battery.
2. **Wiring:** Layout your wiring harness in your engine bay. Using cable ties, secure any loose wires and ensure your relay is securely mounted. Remove the spade terminals from the rear of the switch and find a suitable location to run these into your cabin
3. **Connecting to High Beam Circuit:** Remove your high beam plug from the rear of the headlight and connect it to the piggyback adaptor supplied. The other end of the piggyback adaptor will then connect to the back of your high beam globe. If your vehicle is not fitted with HB3 or H4 high beam bulbs, you may need to splice wires.

Note: This can be fitted to left or right headlight

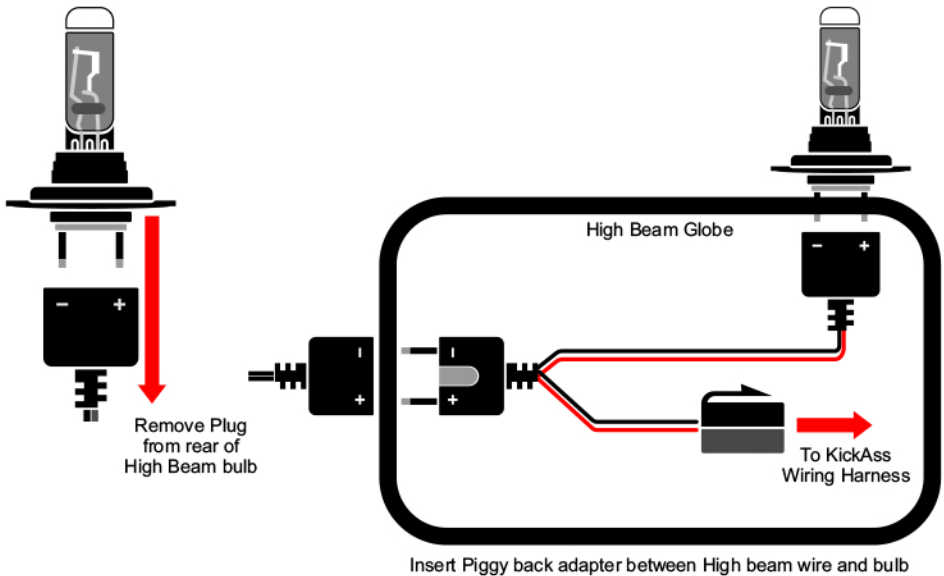

- Installing switch and connecting wires:** Find a suitable location on your dashboard to position the switch. Most dashes will have switch blanks which can be removed with a trim removal tool. To comply with Australian Legislation, the switch must be located at arms reach from the driver's seat. From top to bottom, reconnect the wires in the following order: black, red, blue.

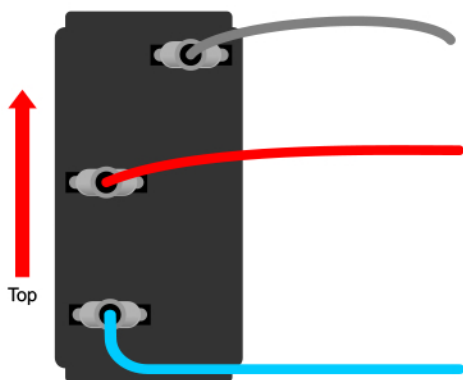

- Connecting Spotlights:** The spotlights are fitted with a waterproof connectors, simply connect these to the connector on the wiring harness ensuring the spring clip locks into place.



- Connecting to battery:** Reconnect your negative terminal to your battery and fit the red ring terminal to the positive and black ring terminal negative battery terminals.
- Test Your Spotlights:** Start your vehicle and turn your low beam headlights on. With the spotlight switch in the off position, turn on your high beam lights, the spotlights should not illuminate. Switching the spotlight switch to the on position, the spotlights should illuminate.

NEED HELP?

KickAss constantly updates frequently asked questions, troubleshooting, videos and specifications, please visit: kickassproducts.com.au for the most up to date information.



THANK YOU FOR CHOOSING

KICKASS[®]



For more information please visit us at:

kickassproducts.com.au