



CONTROL HUB USER MANUAL



TABLE OF CONTENTS

Introduction	1
Important Safety Features	1
Overview	2
Whats Included	2
Features	4
Wiring Diagram	5
Wiring With DCDC Charger	5
Wiring Without DCDC Charger	6
Connections & Accessories	7
Outputs	8
Inputs/Outputs	9
Fuse Box	10
Getting Started	11
Mounting Instructions	11
Wiring Instructions	13
Wiring In Switches	13
Switch Lighting	15
Connecting To Battery	16
DCDC Charger Model	19
Connecting The DCDC Charger	19
Connecting Solar Input	20
Rotating The DCDC Charger	21
Non DCDC Charger Model	24
Mounting Items On The Control Hub	24
DIY VSR Wiring	25
DIY DCDC Install	26
KickAss Lithium Remote Display Unit	27
Wiring Diagram	29

CONGRATULATIONS ON PURCHASING YOUR NEW KICKASS CONTROL HUB

Why KickAss?

KickAss is focused on bringing the luxury of home to the outdoors. Your one stop shop for 12V products. All of our products are designed to be plug and play, for the ultimate camping experience.

Designed by the KickAss team

Our team of dedicated engineers test every product to make sure they stand up to the tough Australian outback. The new KickAss Control Hub is no different! Customised to include the highest quality cables, extra sockets and four Andersons Style connections.

IMPORTANT SAFETY FEATURES

- The lid of the unit must remain shut at all times when the battery is connected to the control hub.
- Any 12V installation work should be done by a professional, failing to do this may result in damage to your unit or vehicle.
- Ensure suitable gauge wiring is used.
- Do not allow any loose metal objects to fall inside the control hub or enter the ports.
- It is the customers responsibility to ensure the unit is adequately mounted.
- Ensure the control hub is shut and the screws are tight before attempting to power any devices.
- In order to prevent an accumulation of heat, ensure there is adequate ventilation to the control hub.
- Do not expose the control hub to excessive moisture or dust.
- Ensure the manual and warnings are understood.

OVERVIEW

WHATS INCLUDED

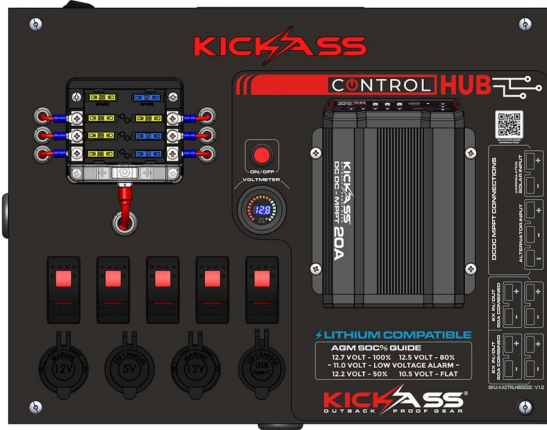

1 X CONTROL HUB (WITH OPTIONAL DCDC CHARGER)

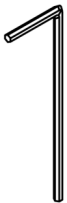

3MM HEX KEY

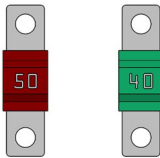

MIDI FUSE

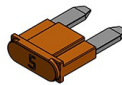

MINI BLADE FUSE

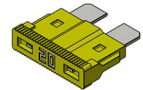

STD BLADE FUSE

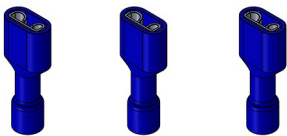

BLUE BLADE TERMINALS

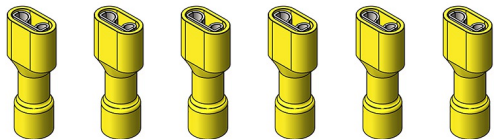

YELLOW BLADE TERMINALS

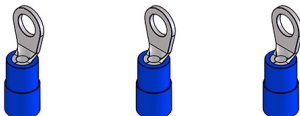

BLUE BLADE TERMINALS



YELLOW RING TERMINALS

SWITCH LABELS



FUSE BOX LABELS



FEATURES

FRONT VIEW

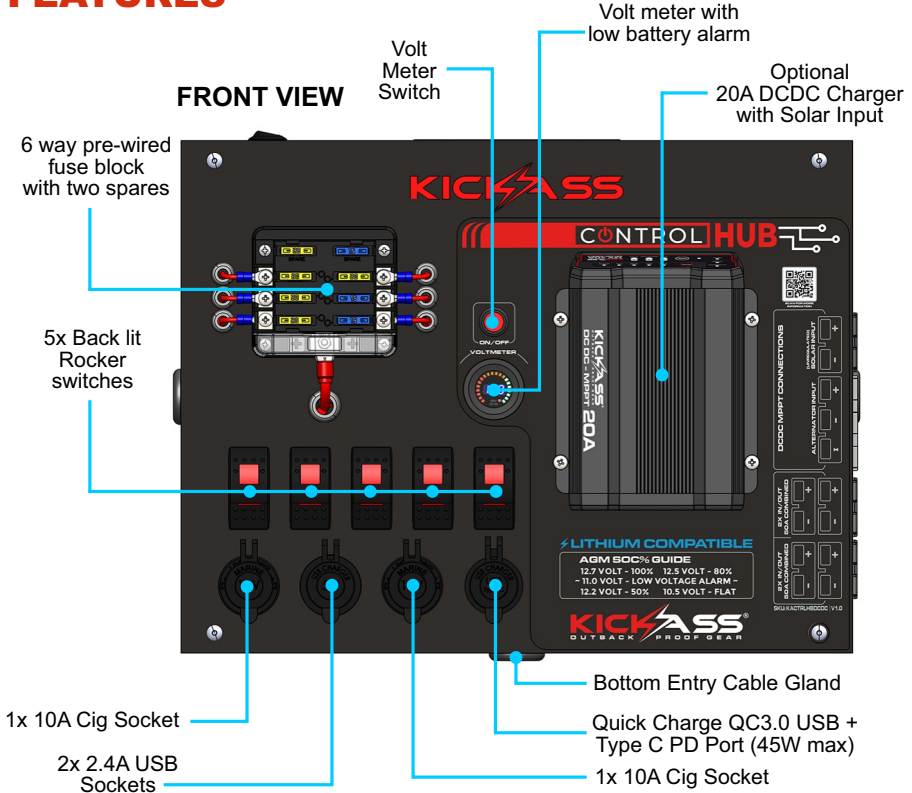

SIDE VIEW

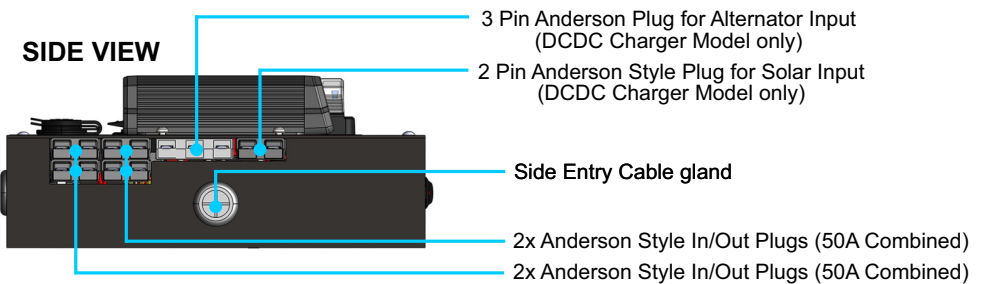

TOP VIEW

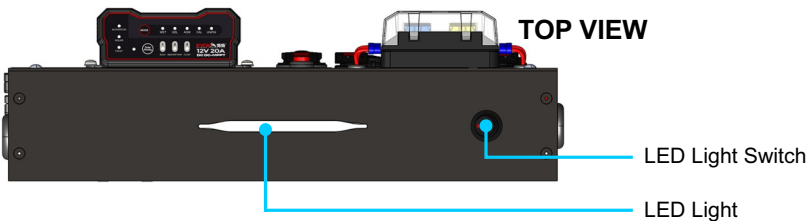

WIRING DIAGRAM

WIRING WITH DCDC CHARGER

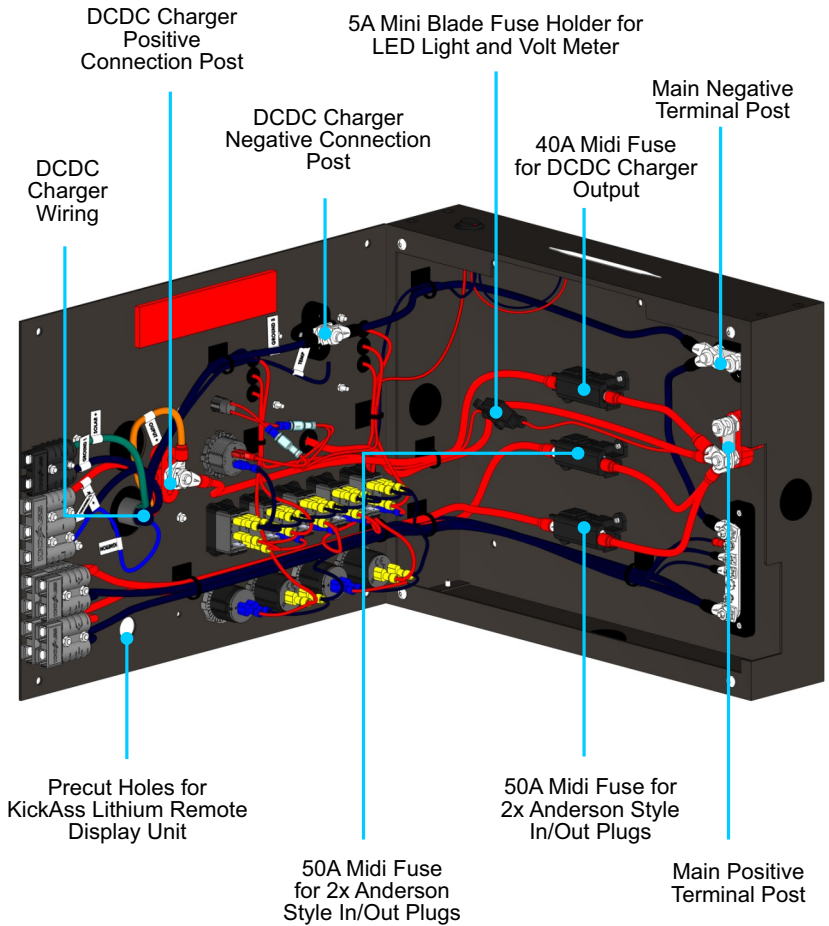

WIRING WITHOUT DCDC CHARGER

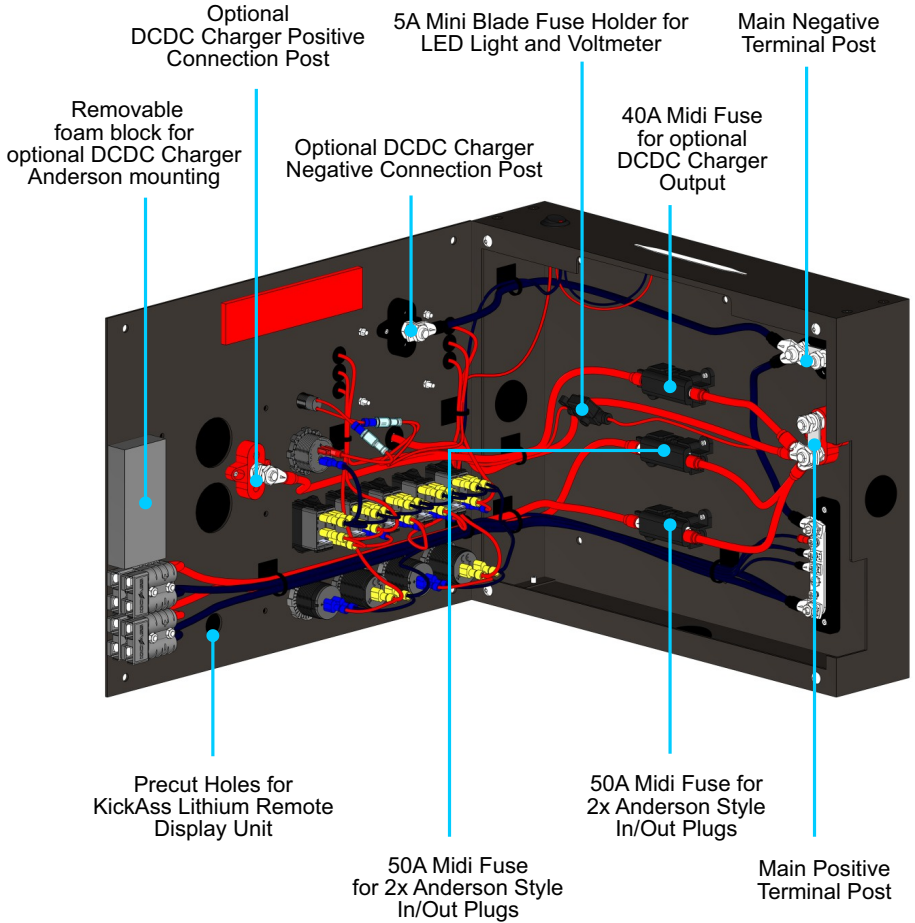

CONNECTIONS & ACCESSORIES

Voltmeter

The inbuilt voltmeter will display the voltage of your battery, this can be turned on and off using the little red switch on the unit. For an accurate voltage reading, disconnect all loads and charging sources from the control hub and test. The voltmeter is equipped with an audible low battery alarm that activates when the voltage below 11.0V. To mute this alarm, simply turn the voltmeter off or connect a charging source.

Note: The battery voltage table on the sticker of the control hub is to be used as a guide for SOC % only, check your battery specifications for accuracy.



LED Light

The control hub is fitted with a LED light. This can be turned on using the switch on the top of the unit. A red LED indicator which will be visible on the switch when powered on.

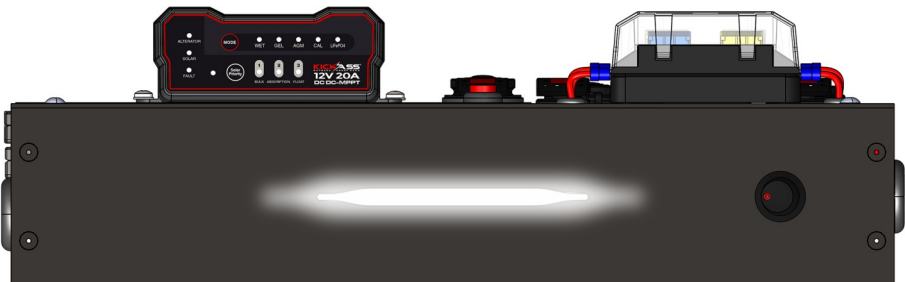

OUTPUTS

USBs

- 2x 2.4A High Powered USB (White)
- 1x Quick Charge QC 3.0 Ultra high powered usb output (5V/3.1A, 9V/2A, 12V/1.5A) (Blue)
- 1x USB-C PD Port (45W Max)

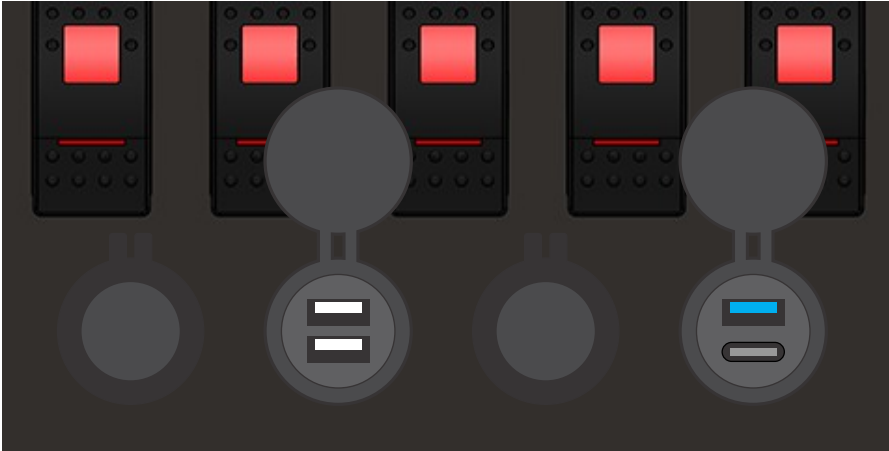

Cigarette Sockets

- 2x Cigarette socket output - maximum 10A per socket

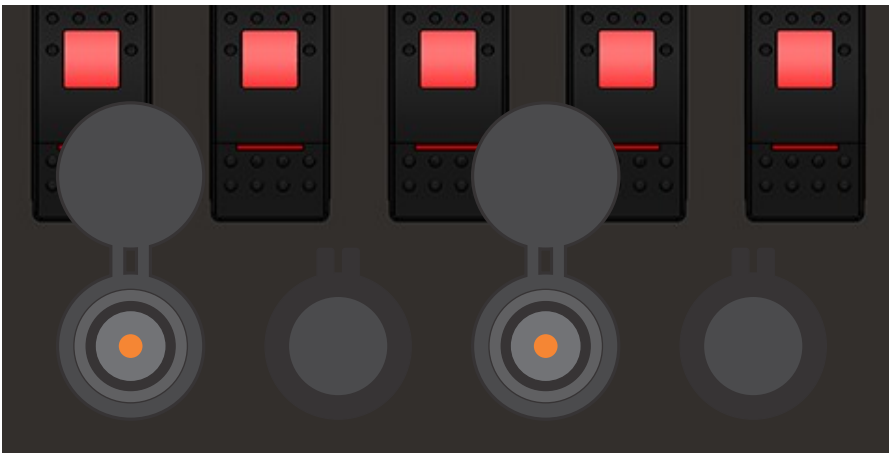

Switches

5x 20A Backlit Rocker Switches

- Easy DIY install to hard wire all your camp accessories
- Included stickers to identify the purpose of the switch
- Each switch is fused with a 20A Fuse

Note: Switches 1 and 2 share a 20A fuse so should only be wired with a maximum combined current of 20A

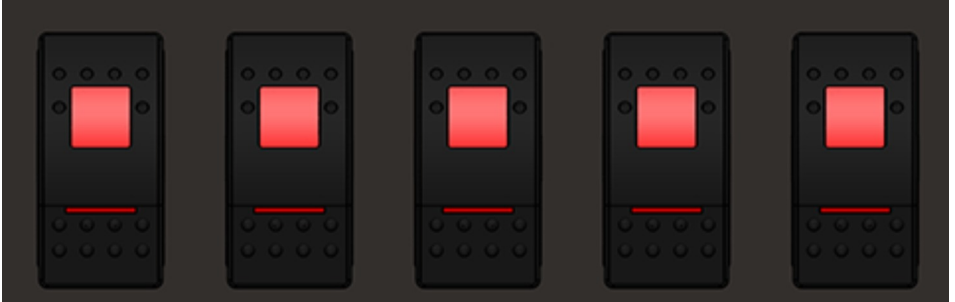

Warning:

Please consider the wiring size used when fitting your accessories. Wiring installed to power lower rated loads may require the existing fuse to be replaced with a smaller sized fuse.

INPUTS/OUTPUTS

4x (50A) Anderson Style Plugs

- Input/Output power supply - Compatible connection to a charger or load
- Two banks of anderson style plugs protected by Midi fuses
- Each Anderson bank must not exceed a maximum of 50A current

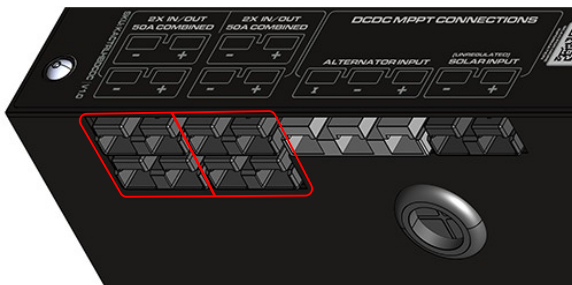

WARNING:

1. Please check product specifications if connecting multiple charging sources.
2. Do not use an external charger while the DC-DC Charger is operating.
3. Exceeding 50A combined current rating on one Anderson bank will blow the fuse. The fuse will need to be replaced with the spare provided.

FUSE BOX

6x Fuse Box with Two Spares

- Prewired for simplicity
- Two spares included
- Blown fuse indicator

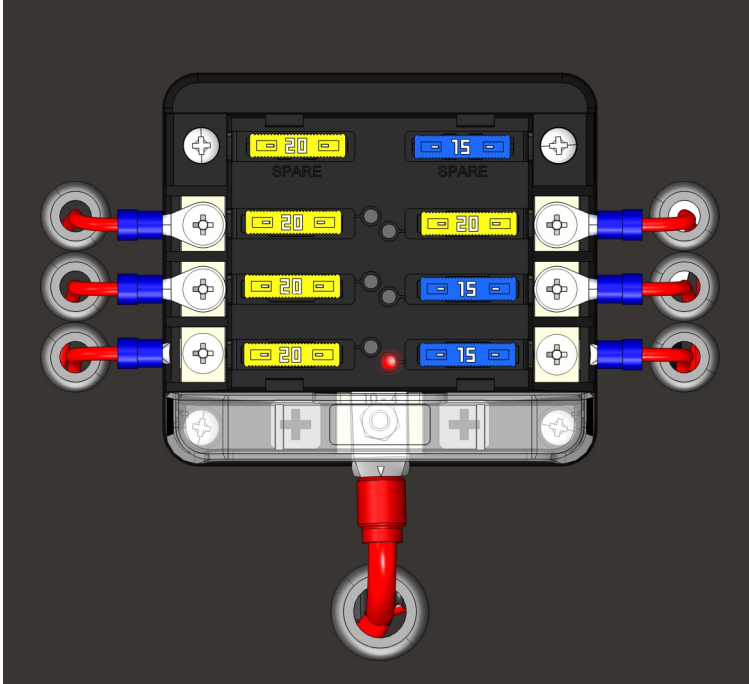

GETTING STARTED

MOUNTING INSTRUCTIONS

What You Will Need



Drill



6mm Drill bit



6 x M5 Nyloc Nuts

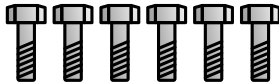

6 x M5 Bolts

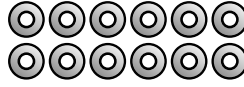

12 x M5 Washers



Spanner
to tighten nuts
and bolts

Step 1: Using the supplied allen key, remove the 4 screws and open the Control Hub.

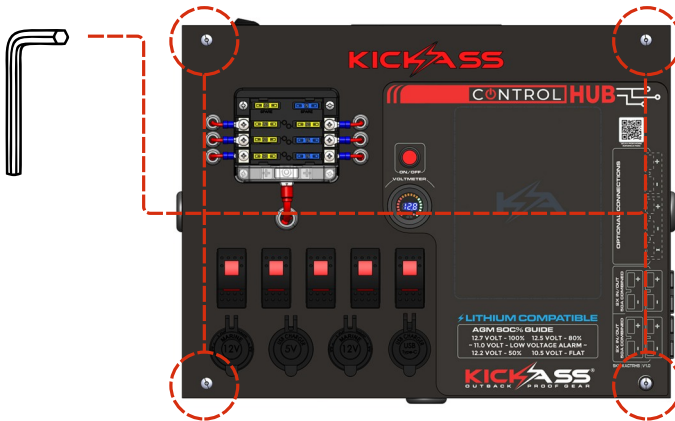

Step 2: Ensure all wiring is connected and there are no internal terminals or studs loose.

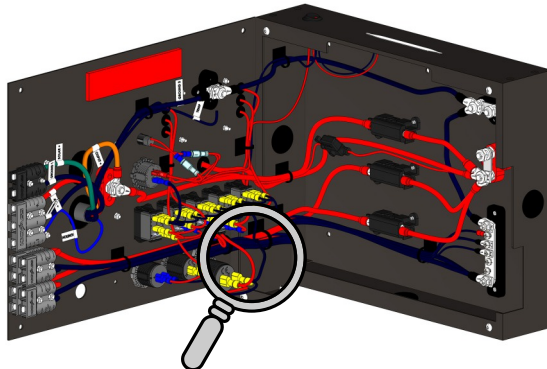

Step 3: Locate the position in your vehicle where you will be mounting your control hub. Making your own template, mark the 6 holes on your mounting surface. Lift the control hub into place to ensure these marks align with the 6 pre drilled holes in the control hub

Step 4: Using a 6mm drill bit, drill through the 6 premarked holes on your mounting surface.
Note: if mounting on a metal surface you may need to use a smaller pilot hole or step drill.

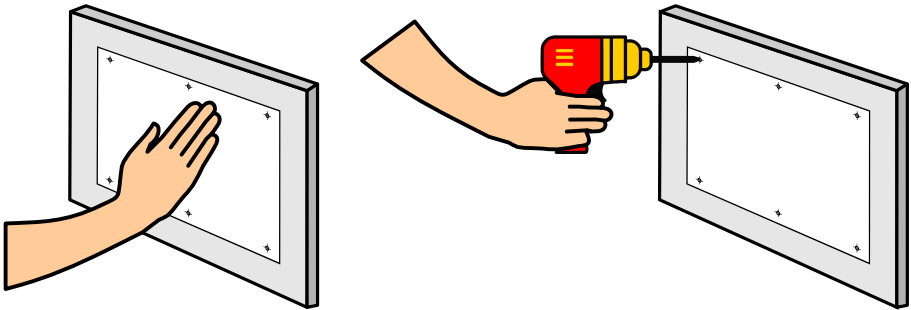

Step 5: Lift the control hub into position and insert the 6 bolts and washers into the pre drilled holes. Secure with a nut and washer on the rear. Tighten with a spanner until secure.

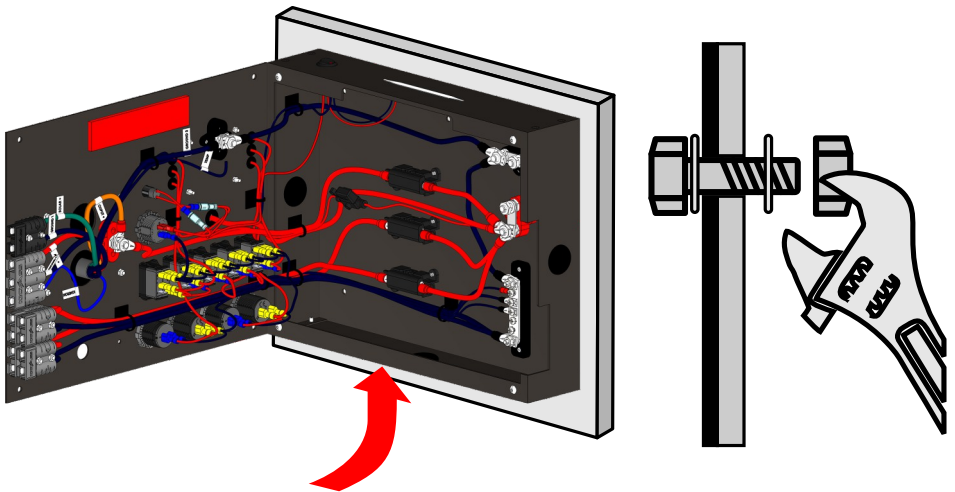

WIRING INSTRUCTIONS

The unit comes fully assembled and ready to use. The following instructions are for wiring in the 5 switches and connecting the unit to your battery

WIRING IN SWITCHES

What You Will Need

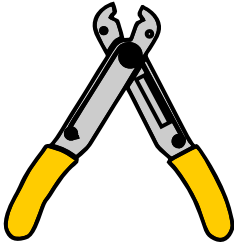

Wire Crimper

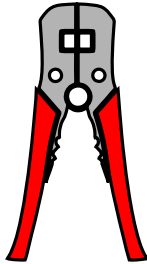

Wire Stripper

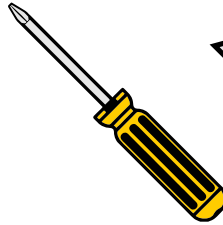

Phillips Head
Screwdriver

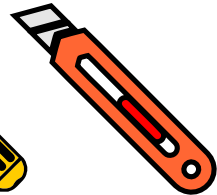

Utility Knife

Note: Ensure the unit is disconnected from the battery prior to attempting any wiring

Step 1: Using the supplied allen key, remove the 4 screws and open the Control Hub

Step 2: For wiring in switches, select the appropriate sized spade and ring terminal for your accessories wiring.

Note: The yellow terminals are recommended for use with 10-12AWG wire and the blue terminals are recommended for use with 12-14AWG wire.

Step 3: Using a knife, cut the grommets on the side or bottom of the unit that your accessory wires will run through. Push approximately 30cm of your accessories wiring through the grommet

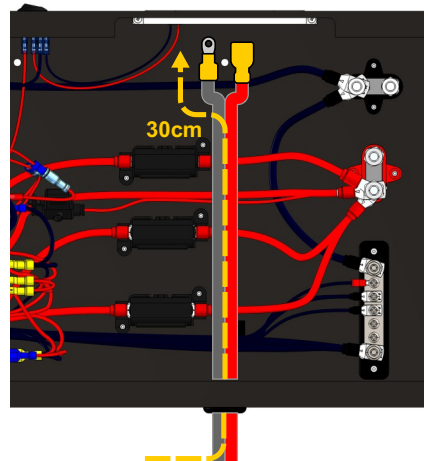
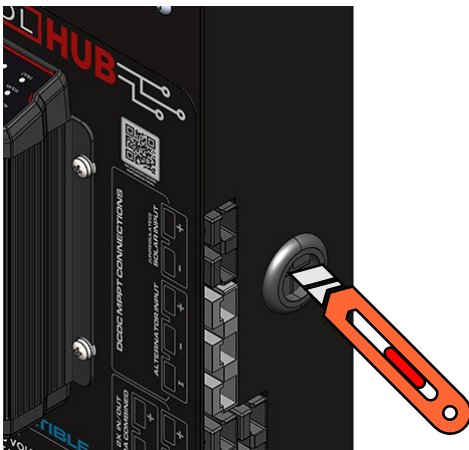

Step 4: If your wiring is dual core, separate approximately 30cm of the two wires.
Note: You may need to remove the 30cm of the outer layer of insulation if your wire is double insulated

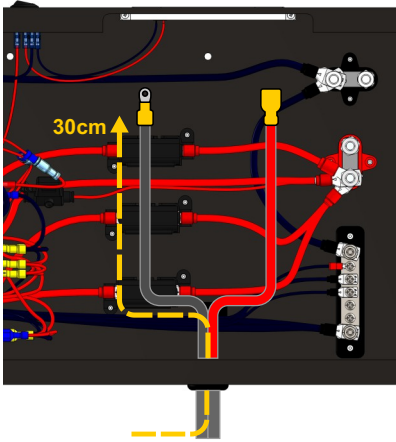

Step 5: Strip approx 1cm of insulation from each cable using a wire stripper, select and crimp the appropriate sized spade terminal to your positive wire and the ring terminal to the negative wire. Note: Check with the manufacturer of your accessory to determine which wire is positive and which is negative crimping terminals.

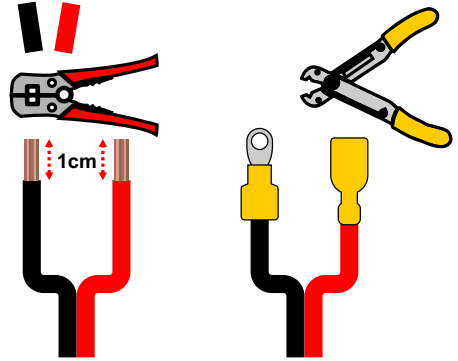

Step 6: Connect the spade terminal to the bottom blank tab on your switch and using a phillips head screwdriver, connect the negative ring terminal to one of the spare screw positions on the negative bus bar.

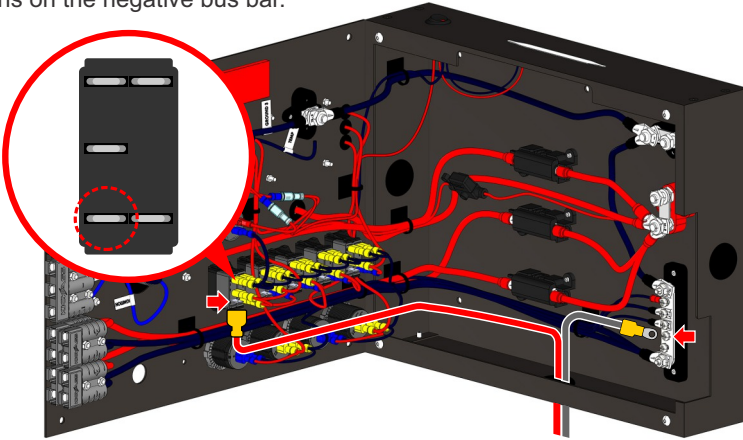

Step 8: Tuck cables neatly under the control hub and carefully close the lid, returning the 4 screws to secure the control hub down

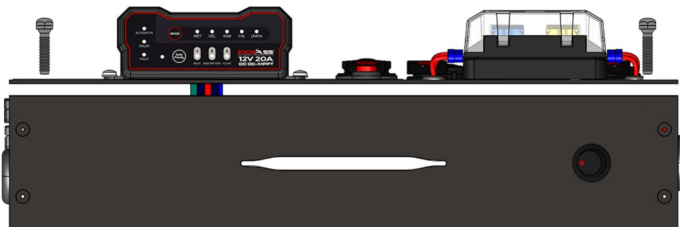

SWITCH LIGHTING

The control hub switches can be wired in three different ways that will change the lighting configuration. Below are the configurations and switch wiring diagrams which can be setup by removing terminal from the rear of the switch as specified below.

Configuration 1 (From Factory):

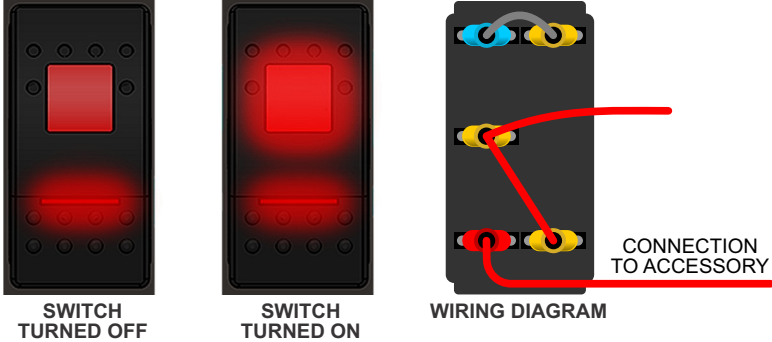

Configuration 2:

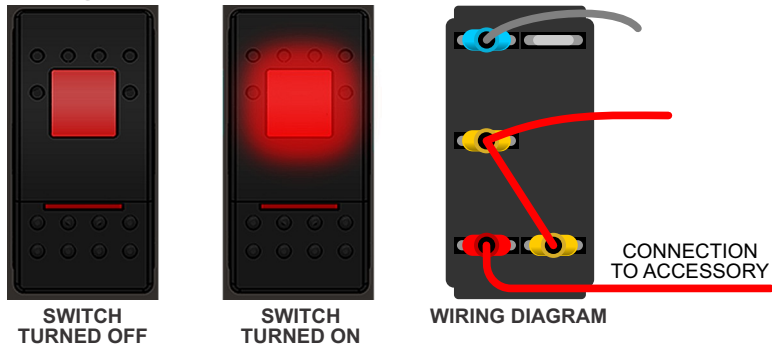

Configuration 3:

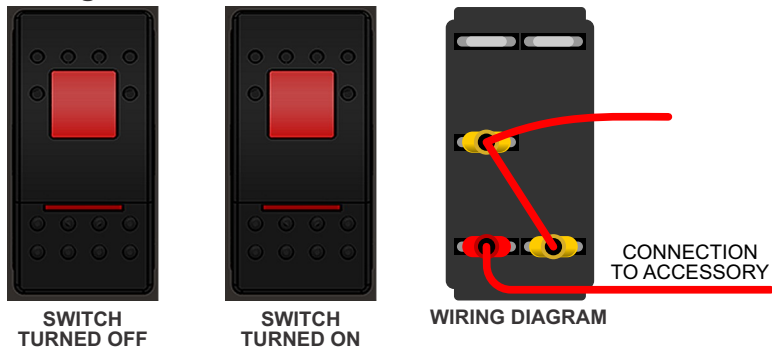

CONNECTING TO BATTERY

What You Will Need



Utility Knife



Adjustable Spanner

Step 1: Using the supplied allen key, remove the 4 screws and open the Control Hub

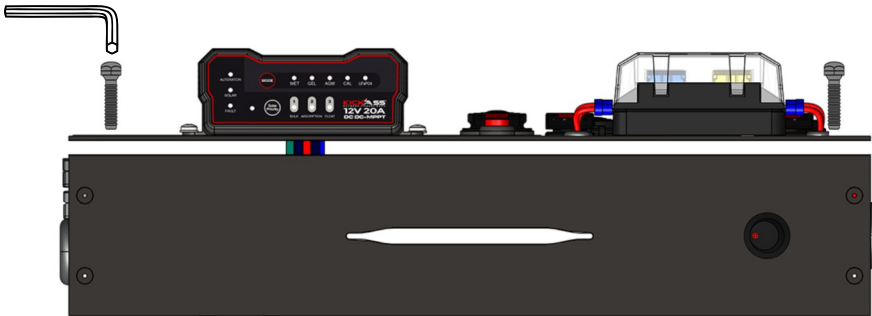

Step 2: Using a knife, cut the grommets on the side or bottom of the unit that your battery wires will run through. Push approximately 30cm of the included battery wire through the grommet

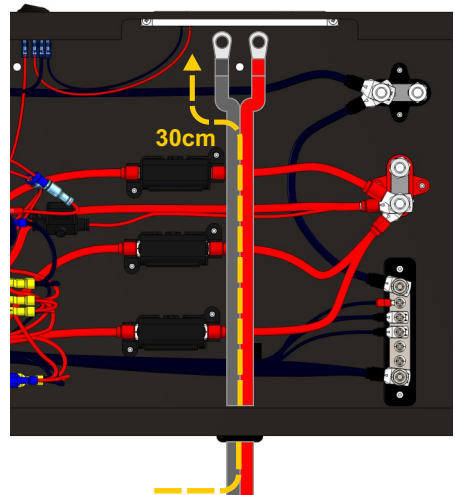
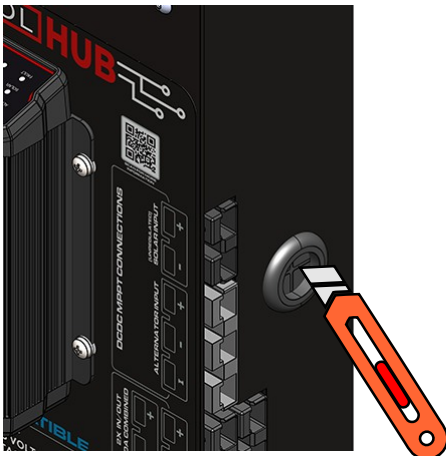

Step 3: Using the spanner, remove the bolt and washer off both the positive (red) and negative (black) terminal posts on the rear of the control hub.

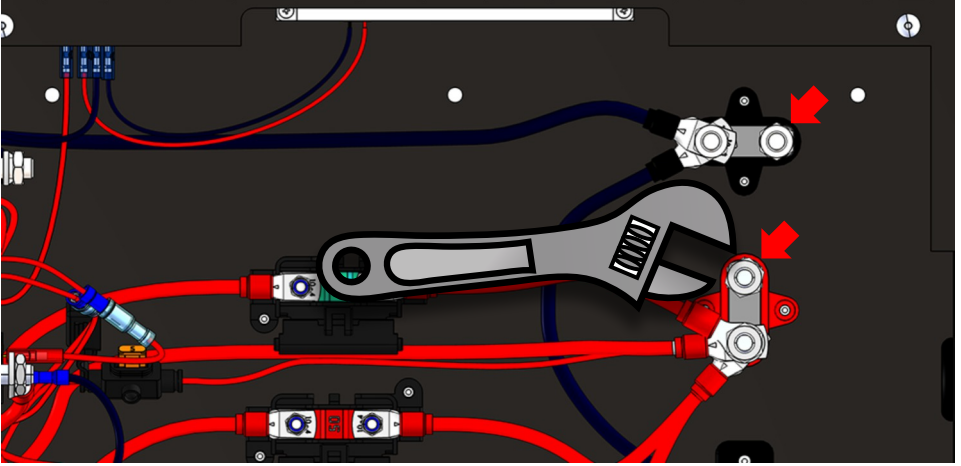

Step 4: Attach the wire with the black terminal cover to the negative (black) terminal post and the wire with the red terminal cover to the positive (red) terminal. Replace the nut and washer and retighten with a spanner. Note: Ensure the wires are not connected to the battery

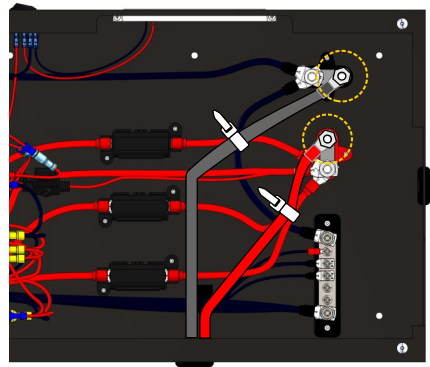

Note: Use cable ties to fix them in place

Step 5: Tuck cables neatly under the control hub and carefully close the lid, returning the 4 screws to secure the control hub down

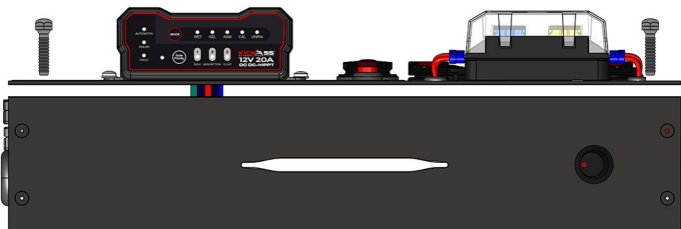

Step 6: Connect the other end of the wires to the battery by first attaching the wire with the red terminal cover to the positive (Red) terminal on your battery, and then attaching the wire with the black terminal cover to the negative (black) terminal on your battery

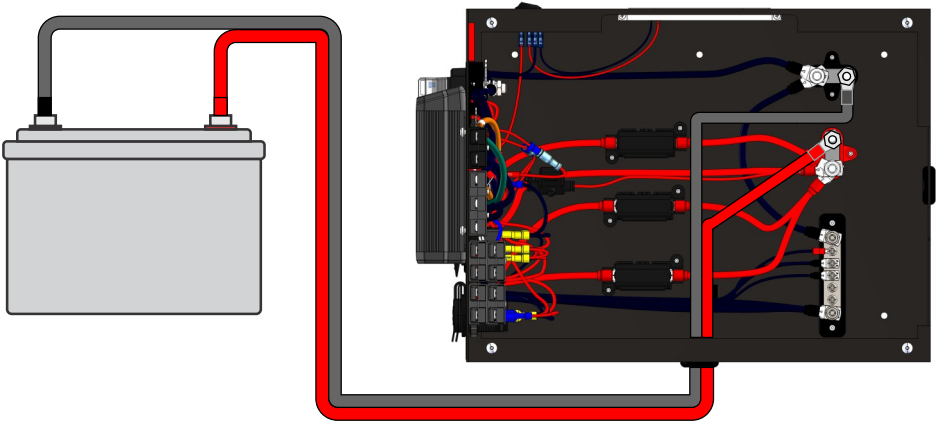

Step 7: Ensure cables between the control hub and battery are adequately supported and not prone to rubbing, you may need to use cable ties to fix them in place.

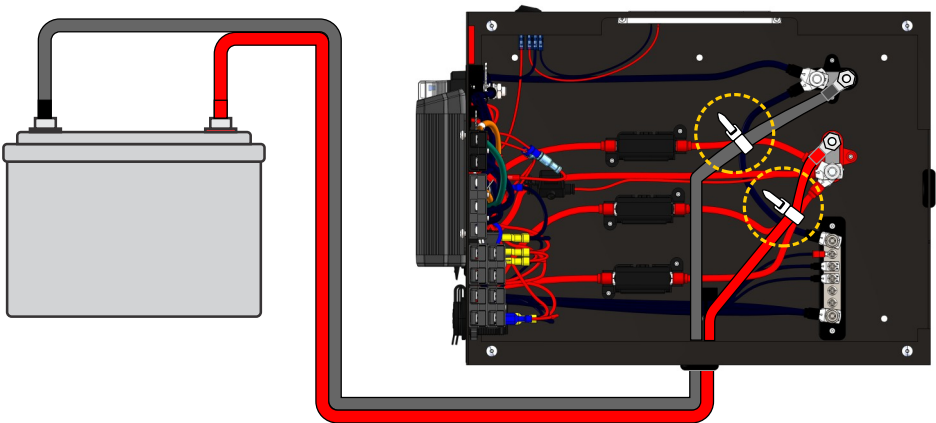

DCDC CHARGER MODEL

The following information only applies to the KickAss Control Hub fitted with a DCDC Charger. For specific information regarding the operation of the DCDC Charger, refer to the specific charger manual.

CONNECTING THE DCDC CHARGER (DCDC CHARGER MODEL ONLY)

The KickAss Control Hub includes a built-in DC-DC Charger suitable for charging from a vehicle alternator. The easiest way to connect the control hub to your vehicle is by using the KickAss Plug & Play Wiring Kit (sold separately).

The triple Anderson style connector fitted to the control hub interfaces with the KickAss Plug & Play Wiring Kit, providing a simple, quick release vehicle charging solution. This triple connector and cable provides alternator power to the DC-DC on the control hub, along with an ignition source for charging in vehicles that are fitted with Smart or Temperature Compensating Alternators.

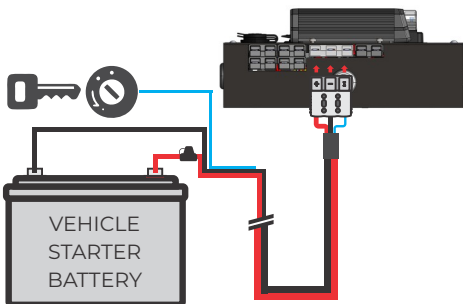
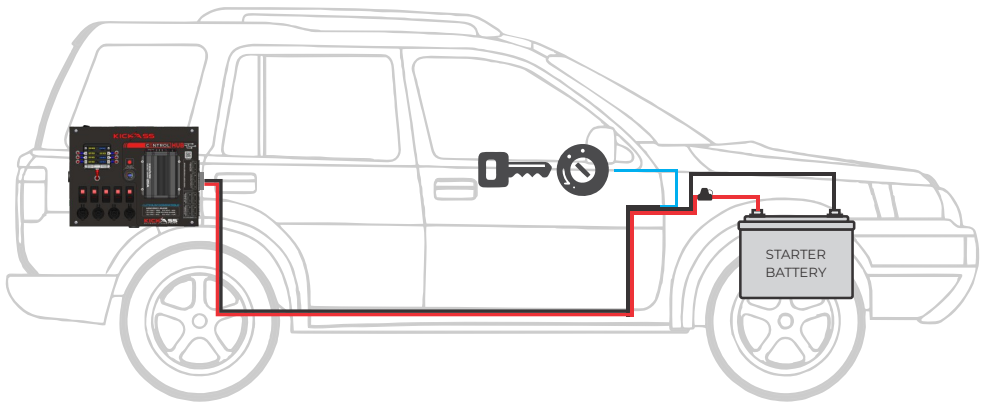

**KICKASS Premium Plug & Play
DC-DC Wiring Kit**

SKU: KAPRDBWK8MMPP

CONNECTING SOLAR INPUT

KickAss Control Hub includes a built-in DCDC Charger with an MPPT regulator suitable for charging from unregulated solar panels. To connect your solar panel to the regulator simply plug it in via the black anderson plug on your control hub.

Note:

- Your solar panel open circuit voltage must not exceed 32 VoC, this can generally be found on the sticker on the rear of your solar panel
- If your solar panel is fitted with a built-in regulator, you will need to bypass the regulator port. Alternatively you can connect your regulated solar panel to any of the in/out anderson style connectors.

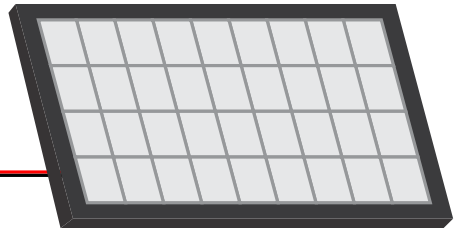

UNREGULATED SOLAR PANEL 32V MAX

ROTATING THE DCDC CHARGER

The KickAss Control Hub has been designed to allow the DCDC charger to be rotated.

What You Will Need

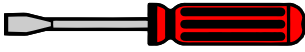

Flat Head
Screwdriver



Phillips Head
Screwdriver



Adjustable
Spanner

Note: Ensure the unit is disconnected from the battery prior to attempting any wiring

Note: It is recommended to take a photo prior to removing wires to ensure all wires are put back in the correct position

Step 1: Using the supplied allen key, remove the 4 screws and open the Control Hub

Step 2: Remove the wires from the solar (Green and Black) and alternator (Red, Black and Blue) Anderson style plugs. *Note: Do not pull to hard on the wire as this may damage the unit*



Insert a flat head screwdriver into the front of the Anderson style plug



Push down the spring clip below the lug pin to release

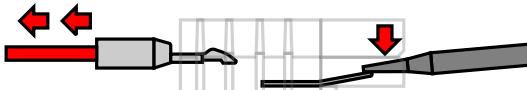

Apply a light pulling force on the wire

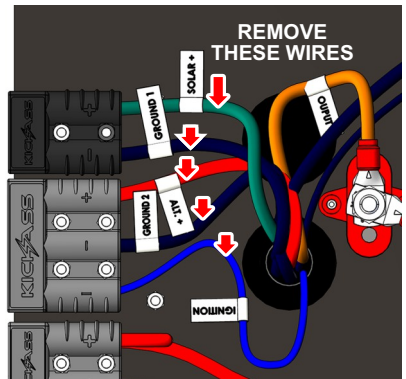

Step 3: Unbolt the DCDC output wires (one brown and two black) from the positive (red) and negative (black) terminal post

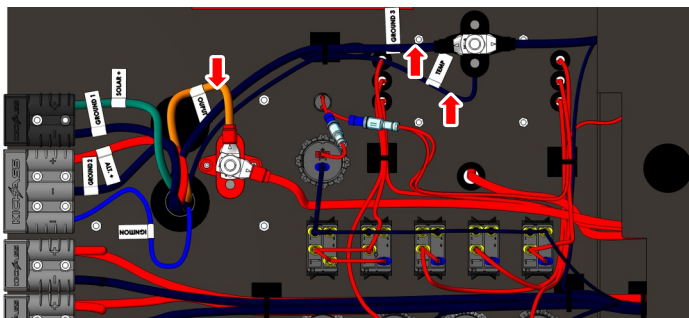

Step 4: Using the phillips head screwdriver and adjustable spanner, undo the four bolts securing the DCDC charger to the control hub

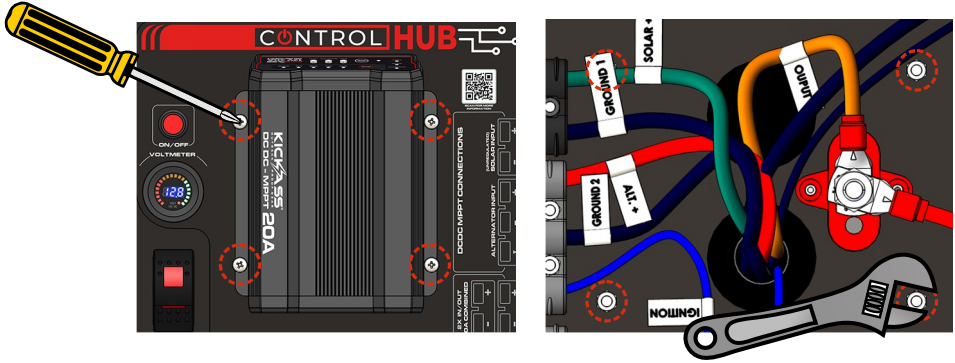

Step 5: Carefully remove the DCDC charger from the control hub ensuring all wires come out freely. *Note: Do not force the unit as you remove it.*

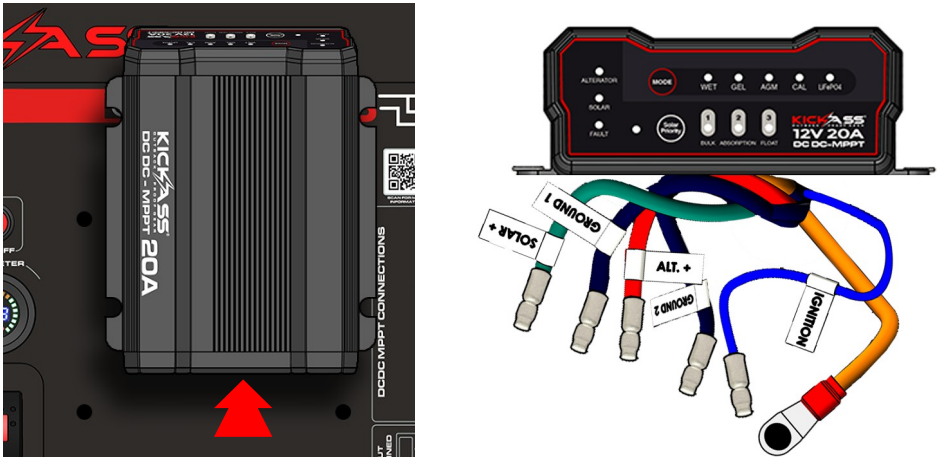

Step 6: Rotate the DCDC Charger and carefully thread the wires through the other large hole located under the DCDC charger's mounting location. Align the mounting holes on the charger with the ones on the control hub and replace the mounting bolts, ensuring they are adequately tightened.

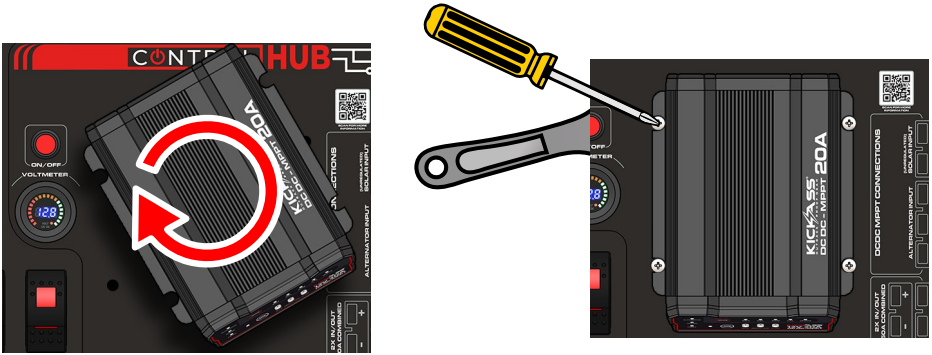

Step 7: Replace the wires from the solar (Green and Black) and alternator (Red, Black and Blue) Anderson style plugs. This can be done by gently pushing the anderson pin into the plug. Note: Do not pull to hard on the wire as this may damage the unit

Note: The order of the wires from top to bottom should be Green, Black, Red, Black, Blue

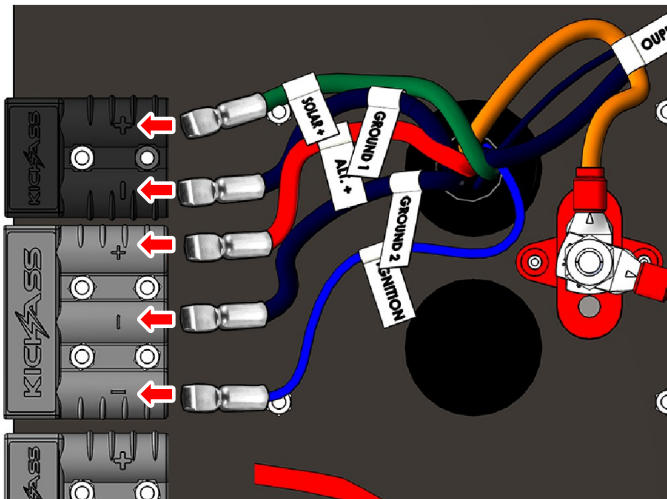

Step 8: Tuck cables neatly under the control hub and carefully close the lid, returning the 4 screws to secure the control hub down

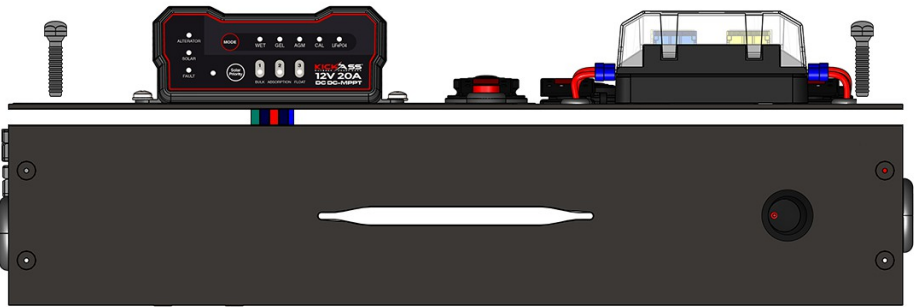

NON DCDC CHARGER MODEL

The following information only applies to the KickAss Control Hubs fitted without a DCDC Charger.

MOUNTING ITEMS ON THE CONTROL HUB

Other auto electrical accessories can be retrofitted to the control hub making use of the free space. The following precautions should be taken when mounting other equipment:

- Prior to drilling through the front face of the control hub, please be wary of hardware and wiring that may be located on the rear side of the face panel
- There are several blank holes covered by the sticker on the front face, you can use these holes for mounting equipment. You can locate these holes by looking at the rear side of the face panel, they have also been shown in the image below
- Mounting a DCDC charger to your control hub will not affect your warranty, unless it is determined to be the cause of the failure.

DIY VSR WIRING

The KickAss Control Hub allows you to create an all in one dual battery system. For vehicles without smart or temperature compensating alternators. We recommend connecting the Control Hub to your vehicle with a Voltage Sensitive Relay via the KickAss Plug & Play Dual Battery System Wiring Kit & Dual Sensing VSR (sold separately)

The Anderson style connector fitted to the control hub interfaces with the KickAss Plug & Play Wiring Kit. This connector and cable provides alternator power to your second battery through the control hub.

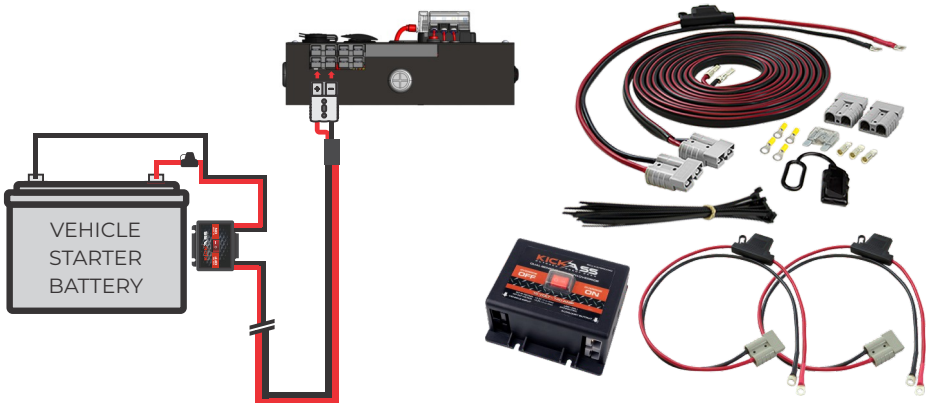
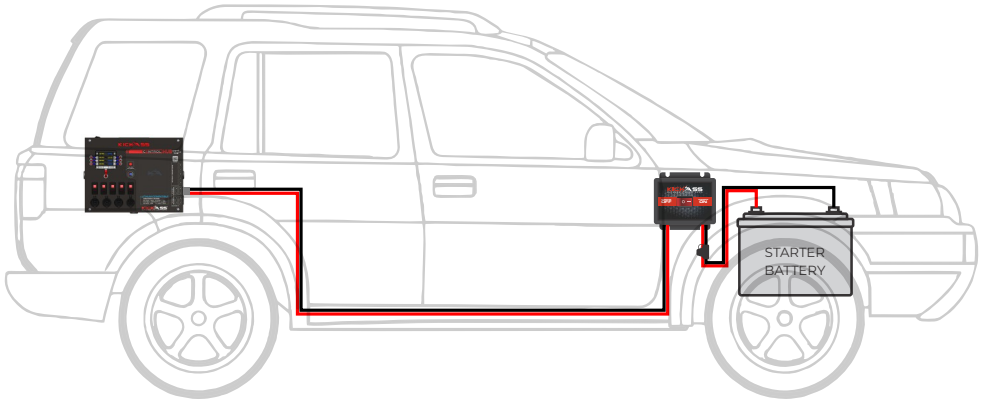

KICKASS Plug & Play Dual Battery System
Wiring Kit & Dual Sensing VSR
SKU: KADBWK8MMVSR2AND

DIY DCDC INSTALL

To install a different brand of DCDC Charger on the Control Hub, follow these instructions.

There are two pre-drilled holes for cabling on the face of the control hub, these are covered by the sticker. Simply locate one of these two holes and find a suitable location for mounting your DCDC on the front face of the unit. Cut the sticker with a sharp knife and drill suitable holes to mount your DCDC Charger.

If you wish to make use of the KickAss Plug and play wiring kits, blank 2 and 3 pin Anderson style plugs are available for purchase from the KickAss Store. These plugs can be mounted easily by cutting away or removing the foam insert on the inside of the control hub.

To connect your DCDC Charger output to your second battery via the control hub, simply attach the output positive to the DCDC charger positive post and the earth output to the DCDC charger ground post. Note: The fuse has been suitably sized for a 25A charger, should you be using a larger charger to may need to increase the fuse size.

Note: Mounting a DCDC charger to your control hub will not affect your warranty, unless it is determined to be the cause of the failure.

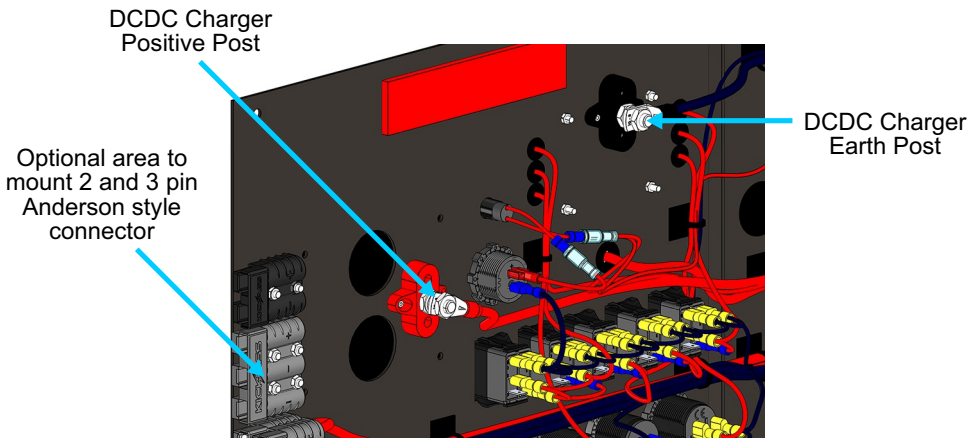
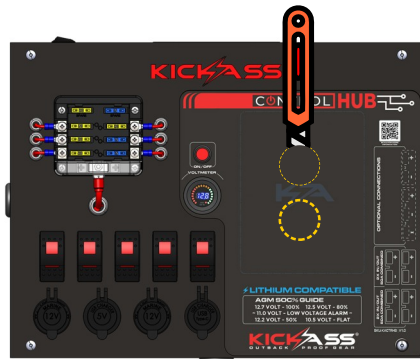

KICKASS LITHIUM REMOTE DISPLAY UNIT

The Control Hub has been designed to work with our KickAss range of lithium batteries. Underneath the sticker, holes have been cut in the face panel to allow you to mount the RDU on the control hub without any drilling.

What You Will Need



KickAss Lithium Battery



RDU and Extension

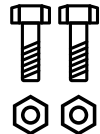

2x M4 Nuts and Bolts

Note: Ensure the unit is disconnected from the battery prior to attempting any wiring

Step 1: Using the supplied allen key, remove the 4 screws and open the Control Hub

Step 2: Locating the 3 holes on the rear side of the face panel, cut away the sticker using a sharp knife.

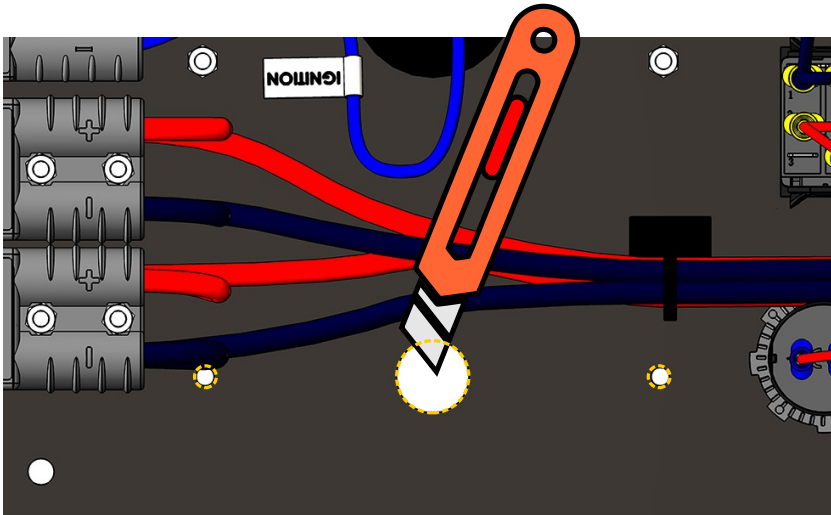

Step 3: Mount the RDU housing on the front face of the Control Hub with M4 nuts and bolts



Step 4: Using the extension cable, connect your RDU to your KickAss Lithium Battery

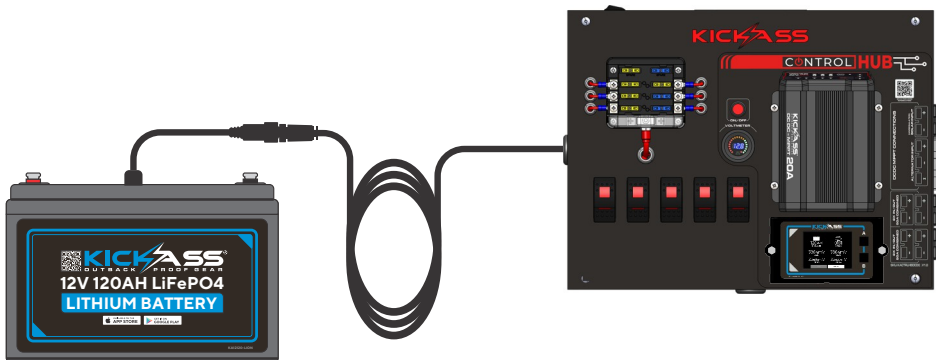

WIRING DIAGRAM

