

FULL LINE



Eighth Edition

Solutions for Cutting, Grinding, Cleaning and Finishing.



WHY WEILER

If you think Weiler is an old fashioned wire brush manufacturing company, you'd be dead wrong. Today Weiler Abrasives is a global manufacturer of surface conditioning solutions with customers in over 80 countries and over 1,200 employees around the world.

Headquartered in the beautiful Pocono Mountains of Pennsylvania, we are proud of the fact that we have built a **progressive, innovative, and high growth** company headquartered right here in the USA. Our world-class products are designed and built by Weiler co-workers who embrace our commitment to customers, the community, and one another.

Weiler Abrasives Group's **heritage dates to 1879**. Today, the tradition of excellence continues under the leadership of the fourth generation, Chris Weiler, President/CEO. Having grown from a power brush manufacturer to a global surface conditioning problem-solver, Weiler Abrasives' mission is to partner with our customers and business partners to ensure their businesses stay productive and profitable. Our people, products, and our strong desire to win deliver a competitive edge that creates growth.



For those who want a competitive edge and productivity-enhancing solutions for cleaning, grinding, cutting, deburring and finishing, Weiler Abrasives is a premier manufacturer who forges collaborative, problem-solving relationships with our customers.

SOLUTIONS FOR ...

METAL FABRICATION



Time is money. The more time spent building a product, the more it costs. And every step adds time. Grinding. Cutting. Cleaning. Finishing.

You want solutions to get the job done. Done right — but done fast.

We hear you.

Before, during and after the weld, we have you covered. Superior performance means maximum aggression and long life. Saving more time. For more productivity. And more profit.

That's the Weiler Abrasives difference.

INDUSTRIAL PRODUCTION



There may be hundreds of differences between your industrial production operation and a competitor's. The ones that matter to you are far fewer.

Cost. Quality. Productivity.

Weiler helps sharpen your competitive edge. Like every production operation is different, so is every production challenge. One solution does not fit all. Weiler experts can examine your specific deburring, cleaning and grinding challenges and recommend customized solutions—solutions designed to optimize your operation.

Those solutions can reduce costs. Improve quality. Maximize productivity. And make your competition ... less competitive.

Don't compromise. Optimize.

MAINTENANCE, REPAIR & OPERATIONS



The facility doesn't run itself. In fact, keeping things going is more than a full-time job. So you depend on MRO supplies to be ready at a moment's notice — if not before.

Weiler has you covered. We know that when certain products are out of stock, certain activities come to a stop. You aren't going to let that happen on your watch — and neither are we.

No matter where you need them. No matter what they are. If they're Weiler products, they're only a click or a phone call away.

You keep the shop running — Weiler Abrasives stands ready.

TABLE OF CONTENTS

Safety Information	5
New Products.....	7
Industrial Grinding Wheels	8-9
Weiler Process Solutions (WPS)	9

BONDED ABRASIVES	10-32
Technical Information	11-13
Cutting Wheels	14-17
Small Diameter Cutting Wheels	16
Large Diameter Cutting Wheels	17
Grinding Wheels	18-19, 32
Combo Wheels	20
Pipeline Wheels	21
Cups, Cones & Plugs	22-23
Foundry Abrasives	24-31

COATED ABRASIVES	33-52
Technical Information	36-37
Flap Discs	32, 38-43
Resin Fiber Discs	44-47
Blending Discs	48
Trim-Kut® Discs	49
Flap Wheels	50-51
Shop Rolls	52

NON-WOVEN ABRASIVES	53-56
Technical Information	54
Unitized Wheels	54
Interleaf Flap Wheels	55
Hand Pads	55
Surface Conditioning Discs	56

POWER BRUSHES	57-105
Technical Information	60-66
Knot Wire Wheels	67-73
Weld Cleaning Brushes	72-73
Crimped Wire Wheels	74-81
Nylon & Tampico Wheels	82
Cup Brushes	83-85
Stem-Mounted End Brushes	86-89
Crosshole Deburring Brushes	90
Power & Hand Tube Brushes	91-95
Crossflex Honing Brushes	96-99
Miniature Brushes	100-101
Non-Sparking Brushes	102-103
Wide Face Brushes	104-105

NYLOX® BRUSHES	106-134
Technical Information	110-116
Engineered Products & Solutions	117
Troubleshooting Guide	118
Small Feature Deburring Products	119-123
Flat Surface Deburring Products	124-127
Targeted Feature Deburring Products	128-130
Application Engineered Wheels	131
Adapters & Drive Arbors	132-133
FME Area Product Solutions	134

PACKAGED PRODUCTS	135-143
Vending-Ready Products	135-139
Display Packaged Products	140-143

MAINTENANCE	144-179
Technical Information	146-147, 172
Brooms, Sweeps & Handles	148-155
Upright Brooms, Dusters & Dust Pans	156-157
Squeegees & Window Brushes	158
Vehicle Care Products	159
Scrub Brushes	160-162
Mops & Accessories	163-164
Masonry & Applicator Brushes	165-166
Scratch Brushes	167-169
Flue Brushes	170
Tube Fitting Brushes	171
Paint & Parts Cleaning Brushes	172-175
Chip & Oil Brushes	176
Marking Brushes	177
Glue & Acid Brushes	178
Paint Rollers & Accessories	179

LEARN MORE:
WEILERABRASIVES.COM

HOW CAN WE HELP YOU? CONTACT US TODAY!

To place an order or locate a distributor in your area, contact our Customer Experience Team at 800-835-9999 or orders@weilerabrasives.com.

For more information and to schedule a consultation with a Weiler Process Solutions expert visit: weilerabrasives.com/wps.
To discuss specific requirements with a specialist call: 800-835.9999.

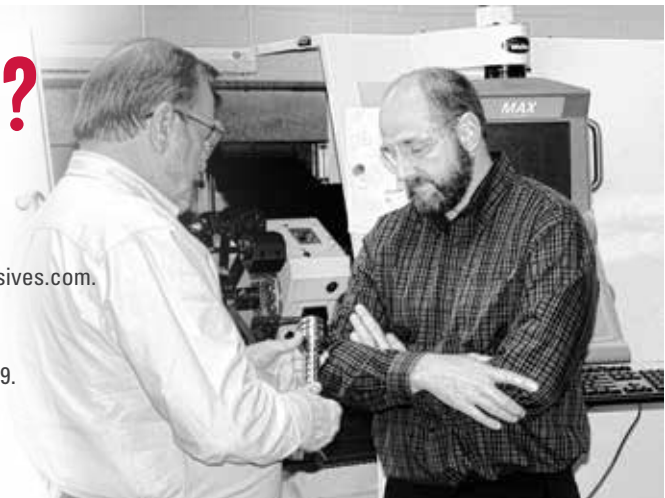

SAFETY INFORMATION

All of Weiler's products are made to the strictest quality standards and specifications and are designed to provide superior work performance and safe operation when used properly.

WARNING: Failure to observe safety precautions may result in injury.

Many manufacturers mark some safety warnings, recommendations and usage restrictions directly on the product. However, it is not always practical to include even the most limited safety information on the product itself. Therefore, the operator **MUST READ** and **FOLLOW** all instructions supplied in or on the product container as well as those marked on the product.

SAFETY STANDARDS - ESTABLISHED BY THE AMERICAN NATIONAL STANDARDS INSTITUTE

Weiler power brushes and abrasives conform to the ANSI standards listed below. All operators of power brushes and abrasives must comply with these safety standards.

- ANSI B165.1 "Power Tools - Power Driven Brushing Tools - Safety Requirements for Design, Care and Use"
- ANSI B7.1 "Safety Requirements - For the Use, Care and Protection of Abrasive Wheels"

AVAILABILITY OF ANSI STANDARDS

Based on the collective experience of the American Brush Manufacturers Association Industrial Division members (ANSI B165.1) and the United Abrasives Manufacturers Association's Bonded Division (ANSI B7.1), both ANSI Standards are referenced and provided solely as a public service for the guidance of the users of the members' products. All Brush and Abrasive recommendations are not necessarily complete with respect to any particular application and common sense safety considerations should generally be followed. Any applicable federal, state, local law or regulation must be strictly adhered to and is controlling over any recommendation contained herein.

TOOL/WORK REST

On bench grinders, tool/work rests should be used to support the work-piece during use. It should have a maximum opening of 1/8" to the product face. Only adjust the rest when the product is not in motion.



Read Instructions



Safety Goggles



Face Shield



Protective Clothing



Hearing Protection



Gloves



Respiratory Protection

SAFETY TRAINING

Weiler products are designed and manufactured to the strictest standards to ensure the highest level of quality and safety. But safety doesn't stop there; raising awareness of basic safety practices and thinking about safety before the job starts — and after the job is complete — can help curb accidents and injuries in the shop. That's why Weiler offers customers a Safety Training Program based on the SPOT (Speed & Size, Pressure, Orientation, Time) methodology to help promote safe and proper product usage.

Deploying our **SPOT SAFETY TRAINING PROGRAM** in your facility helps improve safety, regardless of your application or work environment.

See page 64 for more information or contact your Weiler representative to request S.P.O.T. Training at your facility.

**THINK
SPOT.**
WHEN USING ABRASIVES & BRUSHES





MULTI-PASS

Segments with critical to quality weld applications like Pipeline, Construction, Pressure Vessel, and Structural Metal Fabrication.



SHIPBUILDING

New construction and repair of commercial and military ships.

DELIVERING VALUE TO GLOBAL MARKETS

Weiler Abrasives works in various industrial settings across the globe to solve tough challenges, enabling businesses like yours to get more done, more efficiently.



GEAR GRINDING

High precision gear manufacturers serving Automotive, Aerospace, Power Generation, Shipbuilding, Heavy Equipment, and other industrial segments.

FOUNDRY

Delivering productivity and safety-enhancing solutions for foundry cleaning rooms specializing in cast iron, gray and ductile iron, cast steel, stainless, aluminum, non-ferrous, and titanium.

General Fabrication	Aerospace
Transportation	Automotive
Pipeline Construction	Foundry
Ship Building	Gear
Power Generation	Primary Metals
Building & Construction	Facility Maintenance
Food & Pharma	Manufacturing

PRIMARY METALS

Producers of titanium, specialty alloys, stainless steel, and rail car wheel producers.

WHAT'S NEW?



Pages 22-23

CUPS, CONES & PLUGS FOR METAL FABRICATION

These abrasives deliver the right combination of performance and value. Aluminum oxide grains in combination with a strong bond deliver long product life and a consistent cut-rate for grinding metal.



Pages 24-31

FOUNDRY PORTABLE PRODUCTS

Weiler's manufactures a full line of portable grinding products specially designed for cleaning sand castings, investment castings, and iron.



Pages 67-87

WEILER STAINLESS STEEL BRUSHES, COLOR-CODED FOR EASY IDENTIFICATION

Superior performance is now even easier to see. Our most popular stainless steel brushes are now color-coded black for easy identification, even during operation.

INDUSTRIAL GRINDING WHEELS

DRIVING PRODUCTIVITY

People who take work seriously partner with Weiler Abrasives. We work collaboratively to help solve our customers' biggest challenges.

We understand that every production operation is different, so is every production challenge. One solution does not fit all.

Weiler experts can examine your specific production and product challenges and develop customized solutions that optimize your operation.

Together we will maximize productivity enabling your business to be more efficient and ultimately more profitable.



PRECISION VITRIFIED

Weiler's precision vitrified products use high performance bonding components paired with advanced abrasives to provide the most competitive products in the market. These products are designed to maximize cut rate, reduce cycles times, increase depth of cut, reduce dressing cost and improve surface finish.

Products: Standard and custom profiles that are all CNC finished to tight tolerances with the ability to produce up to 50" diameter wheels



HOT PRESSED CONDITIONING

Weiler specializes in designing high performance conditioning wheels for stainless steel, specialty alloy, carbon steel and titanium applications. These wheels remove hard oxide scale formed in the process of casting slabs, ingots and bars in primary metals facilities.

Products: 24", 25", and 36" diameter hot press metal conditioning wheels

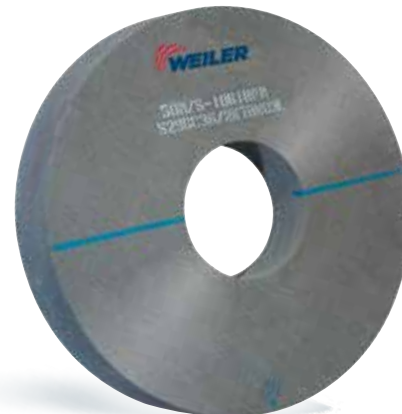

HIGH PERFORMANCE ROLL GRINDING

Weiler produces high performance roll grinding technology for both cold mill and hot mill applications. These wheels are designed to work on rolls ranging from iron roll to specialty tool steel rolls. Our unique technology will maximize your process efficiency and provide substantial cost savings.

Products: Resin and vitrified bonded wheels 30"-42" in diameter

WORLD-CLASS CAPABILITIES

- Best-in-class lead-times
- On-site technical support
- Extensive R&D capabilities
- Unrivaled safety inspection
- Custom wheel shapes
- Newest abrasive and bond technologies
- CNC finishing
- Precision tolerances
- Green manufacturing footprint
- Global distribution network



WPS

Increasing Competitive Capability Through Process Improvements

Weiler Process Solutions (WPS) is a structured application engineering program designed to provide Weiler customers with engineering support to identify value-added cost savings opportunities in their respective processes. WPS is a comprehensive process where our expert application engineers access a specific process in order to identify improvement opportunities resulting in quantifiable cost savings.

WPS BENEFITS INCLUDE:

- Reduced cycle times
- Elimination of bottlenecks
- Reduced consumable and tooling cost
- Elimination of rejections and rework
- Reduced energy consumption
- Reduced work in process
- Documented cost saving
- Documented best practices
- Elimination of process variability

For more information and to schedule a consultation with a WPS expert visit:
www.weilerabrasives.com/wps



GEAR GRINDING

Utilize Weiler's full line of Gear Grinding Solutions to maximize machine efficiency with high performance products that fit all gear grinding applications.

Products: Single profile, bevel, continuous, honing, and hob sharpening products that are designed to pair with any gear grinding machine.



FOUNDRY PORTABLE

Weiler's manufactures a full line of portable grinding products specially designed for cleaning of sand castings, investment castings, and iron.

Products: Cups, various sizes of cones and plugs, snagging wheels, type 27 grinding wheels and various sizes of mounted points.



BONDED ABRASIVES

PERFORMANCE YOU EXPECT

Weiler's line of bonded abrasives deliver consistency and performance to Metal Fabrication professionals. This high quality line includes cutting, grinding and combination wheels that are available in performance tiers, offering a choice between long life, fast cut, or both.

We are proud to introduce a line of abrasives designed to deliver maximum performance in foundry applications. From gate removal to I.D. cleaning, we offer solutions to eliminate bottlenecks in foundry cleaning room operations.

Technical Information	11-13
Cutting Wheels	14-17
Small Diameter Cutting Wheels	16
Large Diameter Cutting Wheels	17
Grinding Wheels	18-19
Combo Wheels	20
Pipeline Wheels	21
Cups, Cones & Plugs	22-23
Foundry Abrasives	24-31





REDUCING VIBRATION

Excessive vibration binds the wheel and makes it difficult to control through the cut.

Check the mounting/clamping point. Ensure that the work piece is clamped securely and as close as possible to the mounting point or vice to allow safe and adequate clearance of the tool, guard and hands.



PUSH VERSUS PULL

Weiler's Tiger grinding wheels are instantly aggressive out of the box. When possible, it is most effective to begin grinding on the pull stroke. This will minimize the risk of undercutting or gouging.

It is common to use more pressure through the push stroke and less pressure during the pull stroke. The most efficient grinding technique requires consistent pressure in both directions. Do not use excessive pressure in either direction and allow the grains do the work. Overpowering a grinding disc will NOT increase cut rate and WILL break down at a faster rate, reducing disc life.



CUTTING ANGLE IRON OR SQUARE TUBING

When clamping angle iron on a table or bench, it is important to fix the piece with the corner perpendicular to the table. When clamping in a vise, the preferred approach is from the corner.

When cutting material with larger surface area like square tubing or angle iron, beginning the cut from a corner reduces friction and will minimize kick-back. After allowing the tool to reach full speed, engage the piece from the corner and work the wheel through the material using consistent pressure. Use light to moderate pressure to work through the cut being careful not to plunge the wheel too deeply into the tube. Depth of cut will depend on wall thickness.



ROUND BAR AND ROUND TUBE

Cutting round bar stock or tubing, is easier since the countered surface provides the same contact surface regardless of angle. Applying light to moderate pressure and consistent movement will provide the most efficient cut and minimize heat build-up.



HEAT DISCOLORATION

Heat is the enemy of any abrasive. To minimize discoloration, use a smooth, consistent rocking motion through the cut.

Approach from the corner and use light pressure and a consistent motion through the cut for the fastest cut-rate and prolonged wheel life. Applying too much pressure through the cut causes increased friction and heat build-up. This can cause increased heat discoloration of the work piece and reduced wheel life.

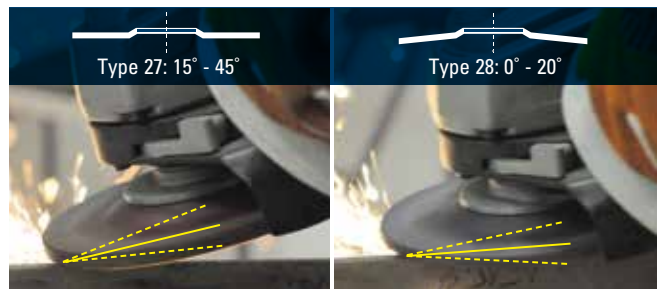

GRINDING ANGLES

The optimal grinding angle for a 1/4" Type 27 grinding wheel is between 15 and 30 degrees. Generally speaking, the steeper the grinding angle, the more aggressive the cut. Grinding at lower angles can prolong life, but will compromise cut rate. When grinding shallow on harder materials, chatter and vibration can become a factor.

When lower grinding angles are required, consider a Type 28 grinding wheel. Its unique saucer profile provides increased aggression at lower grinding angles while also allowing access in tighter areas, such as corners, fillets, and overhangs.

SELECTING THE RIGHT WHEEL

Weiler's bonded abrasive wheels help Metal Fabrication professionals get the most demanding jobs done right, and done fast. Our high quality line helps you select the best solution for your toughest jobs. Whether you're looking for serious stock removal, beveling, grinding, notching, cutting or edge softening, Weiler will get it done for you.



<p>P MAX PERFORMANCE SUPERIOR LIFE & CUT</p> 	<p>CUT RATE: ●●●●● LIFE: ●●●●●</p> <p>TIGER® CERAMIC Self-sharpening and cool – grinds at lower temperatures with less friction and less effort, reducing heat discoloration of the work piece.</p> <p>TIGER® PIPELINE Designed for bead and angle grinding applications on the pipeline.</p>	<p>GRAIN TYPE Ceramic alumina</p> <p>CONTAMINANT FREE CONTAIN LESS THAN 0.1% IRON, SULFUR & CHLORINE</p> <p>GRAIN TYPE Zirconia alumina + ceramic alumina infusion</p>	<p>BEST ON STEEL / METAL STAINLESS HARD-TO-GRIND</p> <p>Hard-to-Grind metals include tool steel, inconel, high nickel alloy, titanium and armored steel</p> <p>BEST ON STEEL / METAL</p>
<p>P HIGH PERFORMANCE FAST CUT & LONG LIFE</p> 	<p>CUT RATE: ●●●●● LIFE: ●●●●●</p> <p>TIGER ZIRC Self-sharpening grains retain a high cut rate throughout the life of the wheel for exceptional performance.</p> <p>TIGER INOX Tiger INOX wheels deliver a worry-free solution for stainless steel applications.</p> <p>TIGER ALUMINUM Weiler's non-loading formula delivers a fast and consistent cut rate on aluminum and soft alloys.</p>	<p>GRAIN TYPE Cutting/Combo: Zirconia alumina Grinding: Zirconia alumina + ceramic alumina infusion</p> <p>GRAIN TYPE White aluminum oxide</p> <p>INOX CONTAMINANT FREE CONTAIN LESS THAN 0.1% IRON, SULFUR & CHLORINE</p> <p>GRAIN TYPE Silicon carbide / aluminum oxide blend</p> <p>CONTAMINANT FREE CONTAIN LESS THAN 0.1% IRON, SULFUR & CHLORINE</p>	<p>BEST ON STEEL / METAL includes structural steel and cast iron</p> <p>BEST ON STAINLESS and harder grade steel</p> <p>BEST ON ALUMINUM</p>
<p>P PERFORMANCE LONG LIFE</p> 	<p>CUT RATE: ●●●●● LIFE: ●●●●●</p> <p>TIGER AO Tiger wheels provide an even, sharp, clean cut and a hard bond extends wheel life.</p>	<p>GRAIN TYPE Aluminum oxide</p>	<p>BEST ON STEEL / METAL</p>
<p>V VALUE FAST CUT</p> 	<p>CUT RATE: ●●●●● LIFE: ●●●●●</p> <p>WOLVERINE® Fast cut rate and consistent performance at a good value.</p>	<p>GRAIN TYPE Aluminum oxide</p>	<p>BEST ON STEEL / METAL</p>



Key:

P PERFORMANCE LINE Industrial Grade **V** VALUE LINE Professional Grade





Refer to ANSI B7.1 for storage & handling details

All products meet ANSI B7.1

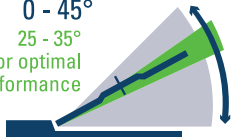
TYPE Selecting the best wheel type for your application increases wheel effectiveness and user productivity.

Cutting	Type 1 (Flat)  Flat profile allows for deep cuts	Type 27 (Depressed Center)  Added clearance when working at a constrained angle
----------------	--	---

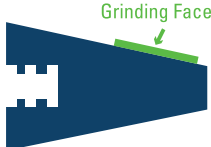
Grinding	Type 28 (Depressed Center)  0 - 30° 0 - 15° for optimal performance Designed for increased aggression at lower working angles and increased access	Type 27 (Depressed Center)  0 - 45° 25 - 35° for optimal performance Flat profile with depressed center allows for a wide range of grinding angles (0-45)
-----------------	--	--

Type 11 Cup 0 - 15° for optimal performance 	Type 16 Cone 	Type 17 Cone 	Type 18 Plug 	Type 18R Plug 
--	--	---	--	---









GRAIN / GRIT / GRADE

Selecting the best grain, grit and grade combination for your application can increase wheel effectiveness and user productivity. Use the charts below to help pick the right wheel for the job.

Grain	Grit	Hardness
C AO ZA ZA+ CG	16 24 30 36 46 60	N P Q R S T U
- DURABILITY +	- COARSE FINE +	- SOFT HARD +
- SELF SHARPENING +		
+ = Ceramic infused		

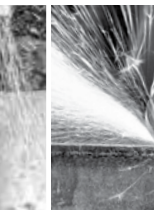
APPLICATION

When selecting a wheel, always choose the thinnest wheel that will perform the cut while maintaining desired product life.

ULTRA THIN WHEEL 1MM	THIN WHEEL .045"	THIN WHEEL .060"	CUTTING WHEEL 3/32"	PIPELINE NOTCHING WHEEL 1/8"	COMBO WHEEL 1/8"	PIPELINE NOTCHING WHEEL 1/8"	GRINDING WHEEL 1/4"	CONES & PLUGS	CUP WHEELS
									
Sheet metal, tubes, profiles and small cross-section rods	Tubes, bar stock and large cross-sections	Angle Iron, large cross-sections	Notching	Switching between cutting and grinding	For tough root pass notching & facing applications on the pipeline	Heavy stock, scale and weld removal, weld blending, edge beveling and torch-cut softening	I.D. cleaning, hole edge beveling, smoothing weld seams, removing gates & parting lines	Heavy metal removal, grinding, transitioning, rough beveling & removing crack & flaws	

WHY WEILER
 BONDED ABRASIVES
 COATED ABRASIVES
 NON-WOVEN ABRASIVES
 POWER BRUSHES
 NYLON BRUSHES

CUTTING WHEELS



Weiler's diverse line of cutting wheels provide a consistent, well balanced, high quality solution. From our 1 millimeter cutting wheels that slice through metal, to our large diameter wheels for the biggest cuts, professionals get the most demanding jobs done right and done fast.

FEATURES:

- **Dual reinforcement** provides added strength for aggressive cutting.
- **Smooth outer layer** on Tiger wheels reduces friction that translates to an effortless cut and less kickback during operation.
- **Thin** cutting wheels deliver accurate, clean cuts.



Cutting a piece of bar stock with an UltraCut wheel.

TYPE 1 FOR GRINDERS



58006



58131



CASE STUDY: Learn how Tiger ZIRC reduced downtime and abrasives spend for a shipping container fabricator.



P HIGH PERFORMANCE THIN CUTTING

TYPE 1
7/8" Arbor

STEEL / METAL TIGER® ZIRC ULTRACUT 1MM / Fast Cut & Long Life

Diameter	Thickness	Grade	Max. RPM	Std. Pack	Item #
4-1/2"	1 mm	Z60T	13,300	50	58005
5"	1 mm	Z60T	12,200	50	58006

STAINLESS TIGER INOX ULTRACUT 1MM / Contaminant-free*

4-1/2"	1 mm	INOX60T	13,300	50	58130
5"	1 mm	INOX60T	12,200	50	58131

*Contaminant-free (Contains less than 0.1% Fe, S, Cl)

CUTS
20%
FASTER
than the closest
competitor

PROPRIETARY
**SOLID
CORE
TECHNOLOGY**

increases wheel density,
resulting in longer life,
reduced friction and
superior stability

A TRUE
**1MM
THICKNESS**

delivers precise, consistent
cuts you can count on



TRUE
1 MILLIMETER

STANDARD
.045"

TYPE 1 & 27 CUTTING WHEELS FOR GRINDERS

P MAX PERFORMANCE CUTTING

STEEL / METAL		TIGER® CERAMIC		TYPE 1 7/8" Arbor		TYPE 27 7/8" Arbor		TYPE 27 5/8"-11 Hub	
STAINLESS		Superior Life & Cut							
HARD-TO-CUT		Contaminant-free*							
Diameter	Thickness	Grade	Max. RPM	Std. Pack	Item #	Std. Pack	Item #	Std. Pack	Item #
4-1/2"	.045"	CER60S	13,300	25	58300	25	58305	10	58306
5"	.045"	CER60S	12,200	25	58301	25	58307	10	58308
6"	.045"	CER60S	10,200	25	58302	25	58309	10	58310
7"	.060"	CER60S	8,500	25	58303	25	58311	10	58312



58300

P HIGH PERFORMANCE CUTTING

STEEL / METAL		TIGER ZIRC / Fast Cut & Long Life		TYPE 1 7/8" Arbor		TYPE 27 7/8" Arbor		TYPE 27 5/8"-11 Hub	
Diameter	Thickness	Grade	Max. RPM	Std. Pack	Item #	Std. Pack	Item #	Std. Pack	Item #
4-1/2"	.045"	Z60T	13,300	25	58000	25	58020	10	58030
5"	.045"	Z60T	12,200	25	58001	25	58021	10	58031
6"	.045"	Z60T	10,200	25	58002	25	58022	10	58032
7"	.060"	Z60T	8,500	25	58003	25	58023	10	58033

STAINLESS		TIGER INOX / Contaminant-free*		TYPE 1 7/8" Arbor		TYPE 27 7/8" Arbor		TYPE 27 5/8"-11 Hub	
Diameter	Thickness	Grade	Max. RPM	Std. Pack	Item #	Std. Pack	Item #	Std. Pack	Item #
4-1/2"	.045"	INOX60S	13,300	25	58100	25	58110	10	58109
5"	.045"	INOX60S	12,200	25	58101	25	58111	—	—
6"	.045"	INOX60S	10,200	25	58102	25	58112	10	58113
7"	.060"	INOX60S	8,500	25	58103	25	58107	—	—

ALUMINUM		TIGER ALUMINUM / Non-loading / Contaminant-free*		TYPE 1 7/8" Arbor		TYPE 27 7/8" Arbor		TYPE 27 5/8"-11 Hub	
Diameter	Thickness	Grade	Max. RPM	Std. Pack	Item #	Std. Pack	Item #	Std. Pack	Item #
4-1/2"	.045"	ALU60S	13,300	25	58200	25	58205	10	58206
5"	.045"	ALU60S	12,200	25	58201	25	58207	10	58208
6"	.045"	ALU60S	10,200	25	58202	25	58209	10	58210
7"	.060"	ALU60S	8,500	25	58203	25	58211	10	58212



58000



58110



58206

P PERFORMANCE CUTTING

STEEL / METAL		TIGER AO / Long Life		TYPE 1 7/8" Arbor		TYPE 27 7/8" Arbor		TYPE 27 5/8"-11 Hub	
Diameter	Thickness	Grade	Max. RPM	Std. Pack	Item #	Std. Pack	Item #	Std. Pack	Item #
4-1/2"	.045"	A60T	13,300	25	57020	25	57041	10	57040
	1/16"	A36T	—	25	57061	—	—	—	—
	3/32"	A36S	—	—	—	25	57081	10	57080
5"	.045"	A60T	12,200	25	57021	25	57043	10	57042
	3/32"	A36S	—	—	—	25	57083	10	57082
6"	.045"	A60T	10,200	25	57022	25	57045	10	57044
7"	.060"	A60T	8,500	25	57023	25	57046	10	57048
9"	1/16"	A60T	6,600	—	—	25	57047	10	57049



57040

* Non-stock product, contact Customer Service for lead times and minimum order quantities.

V CUTTING

STEEL / METAL		WOLVERINE® AO / Fast Cutting		TYPE 1 5/8" Arbor		TYPE 27 5/8" Arbor	
Dia.	Thickness	Grade	Max. RPM	Pack	Item #	Pack	Item #
4"	.035"	A60T	15,300	25	56271	—	—
4"	3/32"	A24T	15,200	—	—	25	56474
5"	.035"	A60T	12,200	25	56108	—	—



57040

56474

V CUTTING

STEEL / METAL		WOLVERINE AO / Fast Cutting		TYPE 1 7/8" Arbor		TYPE 27 7/8" Arbor		TYPE 27 5/8"-11 Hub	
Diameter	Thickness	Grade	Max. RPM	Std. Pack	Item #	Std. Pack	Item #	Std. Pack	Item #
4-1/2"	.045"	A60T	13,300	25	56281	—	—	—	—
	.045"	A60S	—	—	—	25	56393	—	—
	1/16"	A60T	—	25	56103	—	—	—	—
	3/32"	A24T	—	—	—	25	56475	10	56385
5"	.045"	A60S	12,200	—	—	25	56392	—	—
	1/16"	A36T	—	25	56118	—	—	—	—
	3/32"	A24T	—	—	—	25	56476	10	56384
6"	.040"	A60T	10,200	25	56282	—	—	—	—
	.045"	A60T	—	25	56273	—	—	—	—
	.045"	A60S	—	—	—	25	56283	—	—
	3/32"	A24R	—	—	—	25	56277	10	56278
7"	.045"	A60T	8,500	25	56275	—	—	—	—
	.060"	A60S	—	—	—	25	56391	—	—
	3/32"	A24R	—	—	—	25	56383	10	56477



56103

*Contaminant-free (Contains less than 0.1% Fe, S, Cl)

WHY WEILER

BONDED ABRASIVES

COATED ABRASIVES

NON-WOVEN ABRASIVES

POWER BRUSHES

NYLON BRUSHES

PACKAGED ITEMS

MAINTENANCE

TYPE 1 SMALL DIAMETER CUTTING WHEELS



58348



58011



57070



56128

P MAX PERFORMANCE CUTTING

STEEL / METAL TIGER® CERAMIC
STAINLESS Superior Life & Cut
HARD-TO-CUT Contaminant-free*

Dia.	Thickness	Grade	Max. RPM	TYPE 1 1/4" Arbor		TYPE 1 3/8" Arbor	
				Pack	Item #	Pack	Item #
3"	1/16"	CER36T	25,000	100	58345	100	58342
4"	1/16"	CER36T	19,000	25	58351	25	58348

P HIGH PERFORMANCE CUTTING

STEEL / METAL TIGER ZIRC / Fast Cut & Long Life

Dia.	Thickness	Grade	Max. RPM	TYPE 1 1/4" Arbor		TYPE 1 3/8" Arbor	
				Pack	Item #	Pack	Item #
3"	.035"	Z60T	25,000	100	58012	100	58011
4"	.035"	Z60T	19,000	25	58014	25	58013

P PERFORMANCE CUTTING

STEEL / METAL TIGER AO / Long Life

Dia.	Thickness	Grade	Max. RPM	TYPE 1 1/4" Arbor		TYPE 1 3/8" Arbor	
				Pack	Item #	Pack	Item #
2"	.035"	A60T	30,000	100	57014	100	57010
	1/16"	A36T			57015		57011
	1/8"	A36T			57016		57012
3"	.035"	A60T	25,000	100	57065	100	57001
	1/16"	A36T			57066		57060
	1/8"	A36T			57068		57063
4"	.035"	A60T	19,000	25	57075	25	57070
	1/16"	A36T			57076		57071
	1/8"	A36T			57077		57072

V VALUE CUTTING

STEEL / METAL WOLVERINE® AO / Fast Cut

Dia.	Thickness	Grade	Max. RPM	TYPE 1 1/4" Arbor		TYPE 1 3/8" Arbor	
				Pack	Item #	Pack	Item #
2"	.035"	A60T	30,000	100	56013	100	56128
	1/16"	A36T		100	56015	100	56129
	1/8"	A36S		100	56022	100	56130
3"	.035"	A60T	25,000	100	56061	100	56062
	1/16"	A36T		100	56065	100	56068
	1/16"	A60T		—	—	100	56070
	1/8"	A36T		100	56270	100	56076
	1/8"	A36S		50	56060	—	—
4"	.035"	A60T	19,000	25	56165	25	56080
	1/16"	A36T		25	56166	25	56086
	1/8"	A36T		—	—	25	56099
	1/8"	A36S		25	56167	—	—

SMALL DIAMETER SNAGGING WHEELS



57064



56064



57074

P PERFORMANCE SNAGGING

STEEL / METAL TIGER® AO / Long Life

Dia.	Thickness	Grade	Max. RPM	TYPE 1 1/4" Arbor		TYPE 1 3/8" Arbor	
				Pack	Item #	Pack	Item #
3"	1/4"	A24T	25,000	40	57069	40	57064
4"	1/4"	A24T	15,300	10	57078	10	57073

V VALUE SNAGGING

STEEL / METAL WOLVERINE® AO / Fast Cutting

Dia.	Thickness	Grade	Max. RPM	TYPE 1 3/8" Arbor	
				Pack	Item #
2"	1/4"	A36R	30,000	40	56131
3"	1/4"	A24T	25,000	40	56064
4"	1/4"	A36T	15,300	10	56163

P PERFORMANCE SNAGGING

STEEL / METAL TIGER AO / Long Life

Dia.	Thickness	Grade	Max. RPM	TYPE 27 3/8" Arbor	
				Pack	Item #
4"	1/4"	A24T	15,300	10	57074

TYPE 1 FOR CHOP SAWS



P PERFORMANCE CUTTING

STEEL / METAL TIGER AO / Long Life

Diameter	Thickness	Arbor	Grade	Description	Max. RPM	Std. Pack	Item #
12"	3/32"	1"	A36T	Long Life Cutting	5,100	25	57090
14"	3/32"	1"	A36T	Long Life Cutting	4,400	10	57092
14"	3/32"	1"	A36R	Smooth Cutting	4,400	10	57093 ◆
14"	3/32"	1"	A36P	Single Center Reinforcement For + Speed	4,400	10	57084
14"	3/32"	1"	A36P	Stud Cutting	4,400	10	57085
14"	3/32"	1"	EA36T	Fast Cut & Long Life	4,400	10	57086
16"	3/32"	1"	A36P	Long Life Cutting	3,850	10	57087

◆ Softer bond for smoother, faster cutting.

V CUTTING

STEEL / METAL WOLVERINE AO / Fast Cutting

Diameter	Thickness	Arbor	Grade	Description	Max. RPM	Std. Pack	Item #
12"	3/32"	1"	A46T	Fast Cutting	5,100	25	56239
14"	3/32"	1"	A46T	Fast Cutting	4,400	10	56240
14"	3/32"	1"	A46T	Single Center Reinforcement For + Speed	4,400	10	56247

TYPE 1 FOR HIGH SPEED SAWS



P HIGH PERFORMANCE CUTTING

STEEL / METAL TIGER ZIRC / Fast Cut & Long Life / Rail Cutting

Diameter	Thickness	Arbor	Grade	Description	Max. RPM	Std. Pack	Item #
14"	1/8"	1"	Z24U	Rail Cutting	5,500	10	58028
16"	1/8"	1"	Z24U	Rail Cutting	4,800	10	58029

P PERFORMANCE CUTTING

STEEL / METAL TIGER AO / Long Life

Diameter	Thickness	Arbor	Grade	Description	Max. RPM	Std. Pack	Item #
12"	1/8"	1"	A30T	Long Life Cutting	6,400	25	57030
12"	1/8"	20 mm	A30T	Long Life Cutting	6,400	25	57031
14"	1/8"	1"	A30T	Long Life Cutting	5,500	10	57032
14"	1/8"	20 mm	A30T	Long Life Cutting	5,500	10	57094
14"	1/8"	1"	A30T	Triple Reinforcement For + Support	5,500	10	57034
14"	1/8"	20 mm	A30T	Triple Reinforcement For + Support	5,500	10	57035

TYPE 1 FOR STATIONARY SAWS



P PERFORMANCE CUTTING

STEEL / METAL TIGER AO / Long Life

Diameter	Thickness	Arbor	Grade	Description	Max. RPM	Std. Pack	Item #
14"	1/8"	1"	A30R	Long Life Cutting	4,400	10	57091
16"	1/8"	1"	A30S	Long Life Cutting	3,850	10	57089
20"	1/8"	1"	A30S	Long Life Cutting	3,100	10	57097

V CUTTING

STEEL / METAL WOLVERINE AO / Fast Cutting

Diameter	Thickness	Arbor	Grade	Description	Max. RPM	Std. Pack	Item #
14"	1/8"	1"	A30R	Fast Cutting	4,400	10	56230

STUD CUTTING

HIGH PERFORMANCE

RAIL CUTTING

TRIPLE REINFORCEMENT FOR + SUPPORT

TRIPLE REINFORCEMENT FOR + SUPPORT

TRIPLE REINFORCEMENT FOR + SUPPORT

TRIPLE REINFORCEMENT FOR + SUPPORT

TRIPLE REINFORCEMENT FOR + SUPPORT

TRIPLE REINFORCEMENT FOR + SUPPORT



GRINDING WHEELS 0 - 45°



Grinding on a platform for weld preparation.

Weiler's high quality line of grinding wheels help Metal Fabrication professionals get the most demanding jobs done right, and done fast.

FEATURES:

- Tiger type 27 grinding wheels are designed with fiberglass **cut back** from the edge to provide instant aggressive grinding right out of the box.
- **Triple fiberglass reinforcement** provides added strength for aggressive stock removal.
- Type 28 grinding wheels with a concave "or saucer" shape are designed for increased aggression at **lower working angles** and increased access to the work piece.



Cut back provides instant aggressive grinding on new wheels

TYPE 27 FOR GRINDERS

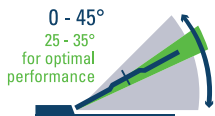

58326



58079



58120



58225



57120

P MAX PERFORMANCE GRINDING

STEEL / METAL TIGER® CERAMIC / Superior Life & Cut
STAINLESS Contaminant-free*
HARD-TO-GRIND

Dia.	Thickness	Grade	Max. RPM	TYPE 27 5/8" Arbor		TYPE 27 7/8" Arbor		TYPE 27 5/8"-11 Hub	
				Std. Pack	Item #	Std. Pack	Item #	Std. Pack	Item #
4"	1/4"	CER24R	15,300	10	58335	—	—	—	—
4-1/2"	1/4"	CER24R	13,300	—	—	10	58325	10	58326
5"	1/4"	CER24R	12,200	—	—	10	58327	10	58328
6"	1/4"	CER24R	10,200	—	—	10	58329	10	58330
7"	1/4"	CER24R	8,500	—	—	10	58331	10	58332
9"	1/4"	CER24R	6,600	—	—	10	58333	10	58334

P HIGH PERFORMANCE GRINDING

STEEL / METAL TIGER ZIRC / Ceramic-infused
Fast Cut & Long Life

Dia.	Thickness	Grade	Max. RPM	TYPE 27 5/8" Arbor		TYPE 27 7/8" Arbor		TYPE 27 5/8"-11 Hub	
				Std. Pack	Item #	Std. Pack	Item #	Std. Pack	Item #
4"	1/4"	Z24T	15,300	10	58069	—	—	—	—
4-1/2"	1/4"	Z24T	13,300	—	—	10	58071	10	58070
5"	1/4"	Z24T	12,200	—	—	10	58073	10	58072
6"	1/4"	Z24T	10,200	—	—	10	58079	10	58078
7"	1/4"	Z24T	8,500	—	—	10	58075	10	58074
9"	1/4"	Z24T	6,600	—	—	10	58077	10	58076

STAINLESS TIGER INOX / Contaminant-free*

4-1/2"	1/4"	INOX24R	13,300	—	—	10	58121	10	58120
5"	1/4"	INOX24R	12,200	—	—	10	58123	10	58122
6"	1/4"	INOX24R	10,200	—	—	10	58129	10	58128
7"	1/4"	INOX24R	8,500	—	—	10	58125	10	58124
9"	1/4"	INOX24R	6,600	—	—	10	58127	10	58126

ALUMINUM TIGER ALUMINUM / Non-loading / Contaminant-free*

4-1/2"	1/4"	ALU24R	13,300	—	—	10	58225	10	58226
5"	1/4"	ALU24R	12,200	—	—	10	58227	10	58228
6"	1/4"	ALU24R	10,200	—	—	10	58229	10	58230
7"	1/4"	ALU24R	8,500	—	—	10	58231	10	58232
9"	1/4"	ALU24R	6,600	—	—	10	58233	10	58234

P PERFORMANCE GRINDING

STEEL / METAL TIGER AO / Long Life

Dia.	Thickness	Grade	Max. RPM	TYPE 27 5/8" Arbor		TYPE 27 7/8" Arbor		TYPE 27 5/8"-11 Hub	
				Std. Pack	Item #	Std. Pack	Item #	Std. Pack	Item #
4"	1/4"	A24R	15,300	10	57119	—	—	—	—
4-1/2"	1/4"	A24R	13,300	—	—	10	57121	10	57120
5"	1/4"	A24R	12,200	—	—	10	57123	10	57122
6"	1/4"	A24R	10,200	—	—	10	57129	10	57128
7"	1/4"	A24R	8,500	—	—	10	57125	10	57124
9"	1/4"	A24R	6,600	—	—	10	57127	10	57126

*Contaminant-free (Contains less than 0.1% Fe, S, C)

CASE STUDY: Learn how Tiger Ceramic increased productivity and reduced cost for a steel fabrication company.



V GRINDING

STEEL / METAL WOLVERINE® AO / Fast Cutting

Diameter	Thickness	Grade	Max. RPM	TYPE 27 5/8" Arbor		TYPE 27 7/8" Arbor		TYPE 27 5/8"-11 Hub	
				Std. Pack	Item #	Std. Pack	Item #	Std. Pack	Item #
4"	1/4"	A24R	15,200	10	56473	—	—	—	—
4-1/2"	1/4"	A24R	13,300	—	—	10	56464	10	56454
4-1/2"	1/4"	A24N	13,300	—	—	10	56457	10	56455
5"	1/4"	A24R	12,200	—	—	10	56466	10	56449
6"	1/4"	A24R	10,200	—	—	10	56280	10	56279
7"	1/4"	A24R	8,500	—	—	10	56467	10	56468
9"	1/4"	A24R	6,600	—	—	10	56469	10	56470



56473

TYPE 28 FOR GRINDERS

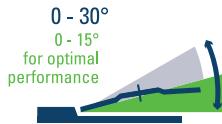

P HIGH PERFORMANCE GRINDING

STEEL / METAL TIGER® ZIRC / Ceramic-infused Fast Cut & Long Life

Diameter	Thickness	Grade	Max. RPM	TYPE 28 7/8" Arbor		TYPE 28 5/8"-11 Hub	
				Std. Pack	Item #	Std. Pack	Item #
7"	1/4"	Z24T	8,500	10	58081	10	58080
9"	1/4"	Z24T	6,600	10	58083	10	58082



58081

P PERFORMANCE GRINDING

STEEL / METAL TIGER AO / Long Life

Diameter	Thickness	Grade	Max. RPM	TYPE 28 7/8" Arbor		TYPE 28 5/8"-11 Hub	
				Std. Pack	Item #	Std. Pack	Item #
7"	1/4"	A24R	8,500	10	57135	10	57134
9"	1/4"	A24R	6,600	10	57137	10	57136



57134

ACCESSORIES

ADAPTING NUTS & SPANNER WRENCH For 4-1/2" - 9" Angle Grinders.

Description	Adapts To	Min. Wheel Thickness	Standard Pack	Item Number
Adapting Nuts	5/8" to 3/8"-24	.045"	1	56484
Adapting Nuts	7/8" to 5/8"-11	.045"	1	56494
Spanner Wrench	—	—	1	56495



56494

56495

MOUNTING MANDRELS 1/4" Stem. For Type 1 Wheels Only.

Arbor Size	Wheel Thickness	Standard Pack	Item Number
1/4"	1/8" to 1/4"	10	56489
3/8"	1/8" to 1/4"	10	56490
1/4", 3/8" *	1/8" to 1/4"	10	56491 *



56489

*Combination pack

ADAPTER for mounting Large Cutting Wheels onto a 20mm arbor.

For Arbor Hole Size	Adapted Arbor Hole Size	Standard Pack	Item Number
1"	20mm	10	04455



04455

COMBO WHEELS



Weld removal with Tiger combo wheel.

Weiler's Combination Wheels offer flexibility and efficiency when switching between cutting and grinding applications. Our **Tiger reinforcement technology** provides the strength to hold up when grinding, while maintaining a fast cut.

TYPE 27 FOR GRINDERS

P MAX PERFORMANCE CUT / GRIND COMBO

STEEL / METAL TIGER® CERAMIC
STAINLESS Superior Life & Cut
HARD-TO-GRIND Contaminant-free*

TYPE 27
7/8" Arbor

TYPE 27
5/8"-11 Hub

Diameter	Thickness	Grade	Max. RPM	Std. Pack	Item #	Std. Pack	Item #
4-1/2"	1/8"	CER30T	13,300	25	58315	10	58316
5"	1/8"	CER30T	12,200	25	58317	10	58318
6"	1/8"	CER30T	10,200	25	58319	10	58320
7"	1/8"	CER30T	8,500	25	58321	10	58322
9"	1/8"	CER30T	6,600	25	58323	10	58324

P HIGH PERFORMANCE CUT / GRIND COMBO

STEEL / METAL TIGER ZIRC / Fast Cut & Long Life

TYPE 27
7/8" Arbor

TYPE 27
5/8"-11 Hub

Diameter	Thickness	Grade	Max. RPM	Std. Pack	Item #	Std. Pack	Item #
4-1/2"	1/8"	Z30T	13,300	25	58051	10	58050
5"	1/8"	Z30T	12,200	25	58053	10	58052
6"	1/8"	Z30T	10,200	25	58064	10	58054
7"	1/8"	Z30T	8,500	25	58056	10	58055
9"	1/8"	Z30T	6,600	25	58058	10	58057

STAINLESS TIGER INOX / Contaminant-free*

Diameter	Thickness	Grade	Max. RPM	Std. Pack	Item #	Std. Pack	Item #
4-1/2"	1/8"	INOX30T	13,300	25	58115	10	58114
7"	1/8"	INOX30T	8,500	25	58117	10	58116
9"	1/8"	INOX30T	6,600	25	58119	10	58118

ALUMINUM TIGER ALUMINUM / Non-loading / Contaminant-free*

Diameter	Thickness	Grade	Max. RPM	Std. Pack	Item #	Std. Pack	Item #
4-1/2"	1/8"	ALU30T	13,300	25	58215	10	58216
5"	1/8"	ALU30T	12,200	25	58217	10	58218
6"	1/8"	ALU30T	10,200	25	58219	10	58220
7"	1/8"	ALU30T	8,500	25	58221	10	58222

P PERFORMANCE CUT / GRIND COMBO

STEEL / METAL TIGER AO / Long Life

TYPE 27
7/8" Arbor

TYPE 27
5/8"-11 Hub

Diameter	Thickness	Grade	Max. RPM	Std. Pack	Item #	Std. Pack	Item #
4-1/2"	1/8"	A30S	13,300	25	57101	10	57100
5"	1/8"	A30S	12,200	25	57103	10	57102
6"	1/8"	A30S	10,200	25	57109	10	57108
7"	1/8"	A30S	8,500	25	57105	10	57104
9"	1/8"	A30S	6,600	25	57107	10	57106

V CUT / GRIND COMBO

STEEL / METAL WOLVERINE® AO / Fast Cutting

TYPE 27
7/8" Arbor

TYPE 27
5/8"-11 Hub

Diameter	Thickness	Grade	Max. RPM	Std. Pack	Item #	Std. Pack	Item #
4-1/2"	1/8"	A24T	13,300	25	56430	10	56429
5"	1/8"	A24T	12,200	25	56428	10	56427
7"	1/8"	A24T	8,500	25	56426	10	56425
9"	1/8"	A24T	6,600	25	56424	10	56423

*Contaminant-free (Contains less than 0.1% Fe, S, Cl)

PIPELINE WHEELS

TYPE 27 FOR PIPELINE

Weiler's Pipeline Grinding Wheels are designed specifically for pipeline applications. Whether grinding a bead, facing the land, prepping transitions, or fabricating in the yard, this wheel is ready to work out of the box, delivering consistent, aggressive grinding throughout the life of the wheel, eliminating the need to chip it.

FEATURES:

- **Do Not Chip** – Operators will no longer feel the need to chip the wheel to get it to bite.
- **Reduced Chatter** – A unique bond formulation delivers reduced vibration for the entire life of the wheel for a better grinding experience.
- **Superior Life & Cut** – A blend of zirconia alumina and ceramic grains bite into the bead and dig out the wagon tracks fast while the strong bond delivers long wheel life.



One Wheel for



GRINDING



NOTCHING

P HIGH PERFORMANCE PIPELINE GRINDING WHEELS

STEEL / METAL TIGER® ZIRC / Ceramic-infused / Fast Grinding & Long Life on Pipe

TYPE 27
5/8"-11 Nut

Diameter	Thickness	Grade	Max. RPM	Std. Pack	Item #
4-1/2"	1/8"	Z30T	13,300	10	58090
6"	1/8"	Z30T	10,200	10	58092
7"	1/8"	Z30T	8,500	10	58094
9"	1/8"	Z30T	6,600	10	58095



58094

TYPE 27 FOR MECHANIZED PIPE WELDING

Weiler's Tiger Mech Wheels are designed for notching applications on mechanical pipe welds. These high-performance wheels are thinner than standard pipe notching wheels, allowing the operator to grind the bead without widening or scarring the bevel.

FEATURES:

- **Designed to Fit** – Tiger Mech reaches the bead without widening the bevel.
- **Optimized Performance** – Designed specifically to grind starts and stops on J and K bevels.
- **Superior Life & Cut** – A blend of Zirconia Alumina and Ceramic grains bite into the bead fast while the strong bond delivers long wheel life.

P HIGH PERFORMANCE MECH NOTCHING WHEELS

STEEL / METAL TIGER ZIRC / Ceramic-infused / Notching Mechanized Pipe Welds

TYPE 27
5/8"-11 Nut

Diameter	Thickness	Grade	Max. RPM	Std. Pack	Item #
4-1/2"	3/32"+	Z30T	13,300	10	58066
5"	3/32"+	Z30T	12,200	10	58067
7"	3/32"+	Z30T	8,500	10	58068

+ Specific size for mechanized pipe welds



NOTCHING



58067

**RISE'N
GRIND**



CUPS, CONES & PLUGS – FOR METAL FABRICATION



Type 11 Cup Rock for snagging and heavy stock removal.

TYPE 11 FOR GRINDERS

BEST ON: Carbon steel, stainless steel, cast iron and ductile iron.



68352



68356



73054

NEW!

TYPE 11 FLARING CUP WHEELS

P

HIGH PERFORMANCE GRINDING

STEEL / METAL TIGER ZIRC / Fast Cut & Long Life

Diameter (D / J)	Thickness (T)	Arbor (H)	Rim (W)	Back (E)	Grade	Max. RPM	Std. Pack	Item #
4" / 3"	2"	5/8"-11	3/4"	3/4"	ZA16Q	9,070	5	68352
5" / 3-3/4"	2"	5/8"-11	1"	3/4"	ZA16Q	7,260	5	68355
6" / 4-3/4"	2"	5/8"-11	1"	3/4"	ZA16Q	6,000	5	68358
6" / 4-3/4"	2"	5/8"-11	1-1/2"	3/4"	ZAC16Q	6,000	5	68361+
6" / 4-3/4"	2"	5/8"-11	1-1/2"	3/4"	ZA16R	6,000	5	68362
6" / 4-3/4"	2"	5/8"-11	1-1/2"	3/4"	ZA16Q	6,000	5	68364

+ Includes silicon carbide for burnt-in sand and hard-to-grind metals.

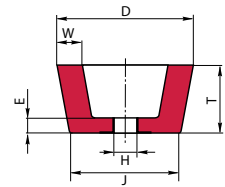

P

PERFORMANCE GRINDING

STEEL / METAL TIGER AO / Long Life

Diameter (D / J)	Thickness (T)	Arbor (H)	Rim (W)	Back (E)	Grade	Max. RPM	Std. Pack	Item #
4" / 3"	2"	5/8"-11	3/4"	3/4"	A16Q	9,070	5	68350
5" / 3-3/4"	2"	5/8"-11	1"	3/4"	A16Q	7,260	5	68353
6" / 4-3/4"	2"	5/8"-11	1"	3/4**	A16Q	6,000	5	68356
6" / 4-3/4"	2"	5/8"-11	1-1/2"	3/4**	A16Q	6,000	5	68359

*Reinforced metal back

CUP WHEEL MOUNTING FLANGE - Fits over 5/8"-11 spindles

Diameter	Thickness	Std. Pack	Item #
2"	1/4"	1	73054

ANCHORED NUT INCREASES SAFETY

Our testing shows that the Weiler anchored safety nut outperformed the industry standard metal back:

- ▶ **Up to 3X higher torque holding strength**
- ▶ **Double speed burst testing ratings**

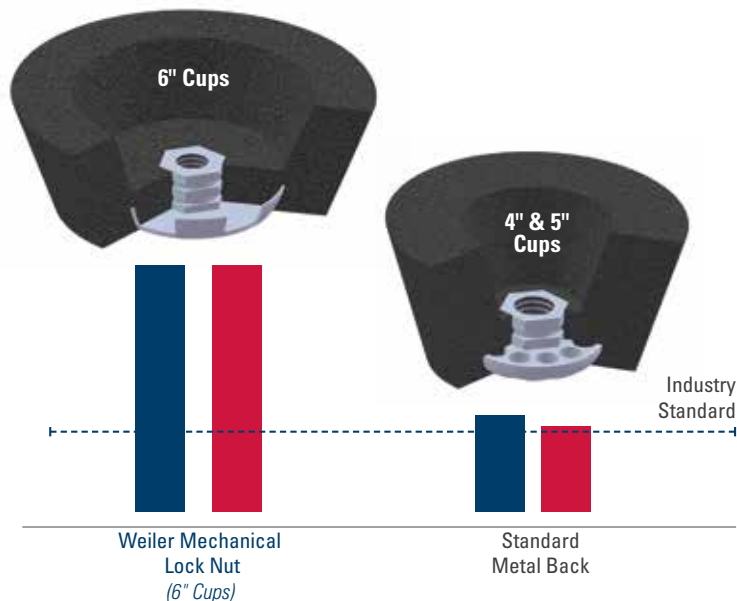

CONES AND PLUGS

FOR STRAIGHT & DIE GRINDERS

CONE & PLUG FEATURES:

- **Open face design** provides aggressive cut-rate right out of the box
- **Anchored hexagon nut** secures the abrasive to the tool to increase safety and prevent product breakage
- **Precision balanced** to ensure smooth, vibration free operation and reduced operator fatigue

APPLICATIONS: Ideal for ID cleaning, hole edge beveling, smoothing weld seams, removing gates and parting lines and cleaning castings in hard-to-reach places



Type 18R plug used to grind I.D. bevels and flatten surface on rail frog section.

BONDED ABRASIVES

COATED ABRASIVES

NON-WOVEN ABRASIVES

POWER BRUSHES

NYLON BRUSHES

PACKAGED ITEMS

MAINTENANCE

NEW!

TYPE 16 CONES
HIGH PERFORMANCE GRINDING

P

STEEL / METAL TIGER ZIRC TYPE 16 CONES / Fast Cut & Long Life

Diameter (D)	Thickness (T)	Arbor (Thread)	Grade	Max. RPM	Std. Pack	Item #
1"	3"	3/8"-24 Nut	ZA20S	36,290	12	68301
1-1/2"	2-1/2"	5/8"-11 Nut	ZA20S	24,190	12	68304
1-1/2"	2"	3/8"-24 Nut	ZA20S	24,190	12	68306
1-1/2"	3"	5/8"-11 Nut	ZA20S	24,190	12	68308
2"	3"	5/8"-11 Nut	ZA20S	18,145	12	68311
2-3/4"	3-1/2"	5/8"-11 Nut	ZA20S	13,195	12	68313

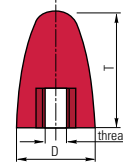

P

PERFORMANCE GRINDING STEEL / METAL TIGER AO / Long Life

Diameter (D)	Thickness (T)	Arbor (Thread)	Grade	Max. RPM	Std. Pack	Item #
1"	3"	3/8"-24 Nut	A24R	36,290	12	68300
1-1/2"	2-1/2"	3/8"-24 Nut	A24R	24,190	12	68302
1-1/2"	2-1/2"	5/8"-11 Nut	A24R	24,190	12	68303
1-1/2"	3"	3/8"-24 Nut	A24R	24,190	12	68305
1-1/2"	3"	5/8"-11 Nut	A24R	24,190	12	68307
2"	3"	3/8"-24 Nut	A24R	18,145	12	68309
2"	3"	5/8"-11 Nut	A24R	18,145	12	68310
2-3/4"	3"	5/8"-11 Nut	A24R	13,195	12	68312
3"	3"	5/8"-11 Nut	A24R	12,100	12	68314

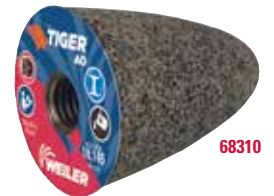

NEW!

TYPE 17 CONES
HIGH PERFORMANCE GRINDING

P

STEEL / METAL TIGER ZIRC TYPE 17 CONES / Fast Cut & Long Life

Diameter (D)	Thickness (T)	Arbor (Thread)	Grade	Max. RPM	Std. Pack	Item #
2"	3"	5/8"-11 Nut	ZA20S	18,145	12	68365

P

PERFORMANCE GRINDING STEEL / METAL TIGER AO / Long Life

Diameter (D)	Thickness (T)	Arbor (Thread)	Grade	Max. RPM	Std. Pack	Item #
1-1/2"	3"	3/8"-24 Nut	A24R	24,190	12	68315
1-3/4"	3"	5/8"-11 Nut	A24R	20,740	12	68316
2"	3"	5/8"-11 Nut	A24R	18,145	12	68317

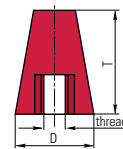

NEW!

TYPE 18 PLUGS
HIGH PERFORMANCE GRINDING

P

STEEL / METAL TIGER ZIRC TYPE 18 PLUGS / Fast Cut & Long Life

Diameter (D)	Thickness (T)	Arbor (Thread)	Grade	Max. RPM	Std. Pack	Item #
1-1/2"	2-1/2"	5/8"-11 Nut	ZA20S	24,190	12	68320
1-1/2"	3"	5/8"-11 Nut	ZA20S	24,190	12	68322
2"	3"	5/8"-11 Nut	ZA20S	18,145	12	68324

P

PERFORMANCE GRINDING STEEL / METAL TIGER AO / Long Life

Diameter (D)	Thickness (T)	Arbor (Thread)	Grade	Max. RPM	Std. Pack	Item #
1-1/2"	2-1/2"	3/8"-24 Nut	A24R	24,190	12	68318
1-1/2"	2-1/2"	5/8"-11 Nut	A24R	24,190	12	68319
1-1/2"	3"	5/8"-11 Nut	A24R	24,190	12	68321
2"	3"	5/8"-11 Nut	A24R	18,145	12	68323

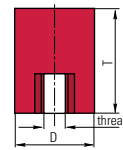

NEW!

TYPE 18R PLUGS
HIGH PERFORMANCE GRINDING

P

STEEL / METAL TIGER ZIRC TYPE 18R PLUGS / Fast Cut & Long Life

Diameter (D)	Thickness (T)	Arbor (Thread)	Grade	Max. RPM	Std. Pack	Item #
1-1/2"	3"	3/8"-24 Nut	ZA20S	24,190	12	68326
1-1/2"	3"	5/8"-11 Nut	ZA20S	24,190	12	68328
2"	3"	5/8"-11 Nut	ZA20S	18,145	12	68330

P

PERFORMANCE GRINDING STEEL / METAL TIGER AO / Long Life

Diameter (D)	Thickness (T)	Arbor (Thread)	Grade	Max. RPM	Std. Pack	Item #
1-1/2"	3"	3/8"-24 Nut	A24R	24,190	12	68325
1-1/2"	3"	5/8"-11 Nut	A24R	24,190	12	68327
2"	3"	5/8"-11 Nut	A24R	18,145	12	68329
3"	3"	5/8"-11 Nut	A24R	12,100	12	68331

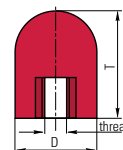

JOIN THE NEXT **REVOLUTION** IN FOUNDRY GRINDING

The finishing process in foundries is a tough job. For decades, abrasives technology for off-hand grinding has remained unchanged. It's time for improvement, faster grinding rates, decreased cycle times and an improved operator experience. It's time for a revolution.

As an industry leader and global manufacturer of surface conditioning solutions, Weiler Abrasives is driven to help you overcome the toughest cleaning, grinding, cutting, deburring and finishing challenges. That's why we created a line of abrasives specifically designed to deliver maximum performance in foundry applications. From gate removal to id-cleaning, Weiler offers the right product solutions and expertise to help you find production and process efficiencies in your cleaning room.

Weiler Foundry Products — A **REVOLUTION** in foundry grinding.

WE PROVIDE VALUE THROUGH:

- ▶ *Ground Breaking Abrasive Technology For Foundry Applications*
- ▶ *Enhanced Safety Features*
- ▶ *Improved Operator Experience*
- ▶ *Expert Abrasives On-Site Technical Support*
- ▶ *Product Available When You Need It*
- ▶ *Custom Engineered Solutions*
- ▶ *Maximum Productivity*
- ▶ *Lowest Cost Of Use*

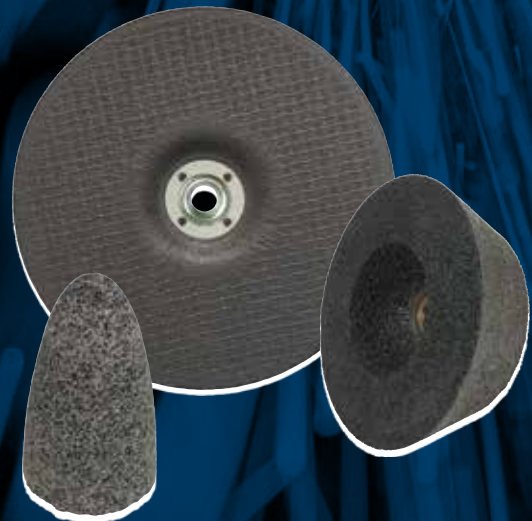

PRODUCT SELECTION

WHY WEILER
BONDED ABRASIVES
 COATED ABRASIVES
 NON-WOVEN ABRASIVES
 POWER BRUSHES
 NYLOX BRUSHES
 PACKAGED ITEMS
 MAINTENANCE

P **MAX PERFORMANCE**
SUPERIOR LIFE & CUT



CUT RATE: ●●●●●
 LIFE: ●●●●●

TIGER® CERAMIC
 Self-sharpening ceramic alumina grains provide ultra-high metal removal rates and optimal productivity.

GRAIN TYPE
 Ceramic alumina

BEST ON
CAST IRON **DUCTILE IRON**
CAST STEEL **HARD-TO-GRIND**
 white iron, gray iron, high nickel alloy and stainless steel

P **HIGH PERFORMANCE**
FAST CUT & LONG LIFE



CUT RATE: ●●●●●
 LIFE: ●●●●●

TIGER ZIRC
 Sharp and durable zirconia alumina grains provide fast and consistent metal removal rates throughout the life of the abrasive.

GRAIN TYPE
 Zirconia alumina

BEST ON
CAST IRON **DUCTILE IRON**
CAST STEEL
 white iron, gray iron, high nickel alloy and stainless steel

P **PERFORMANCE**
LONG LIFE



CUT RATE: ●●●●●
 LIFE: ●●●●●

TIGER SiC
 Silicon carbide grains provide a consistent, controlled cut-rate on sand castings with burnt-in sand.

GRAIN TYPE
 Silicon carbide

BEST ON
BURNT IN SAND



TIGER AO
 Aluminum oxide grains provide an even, sharp, clean cut-rate and consistent performance.

GRAIN TYPE
 Aluminum oxide

BEST ON
CAST IRON
 ductile iron, carbon steel and stainless steel

Refer to ANSI B7.1 for storage & handling details

Key:
P PERFORMANCE LINE
 Industrial Grade

All products meet ANSI B7.1

TYPE 11 CUP WHEELS

Designed for use on medium to high power pneumatic and high frequency electric grinders.



Weiler Tiger® type 11 flaring cup grinding wheels deliver the next evolution in technology for portable foundry grinding. From Tiger Ceramic, which provides superior productivity, to Tiger SiC for castings with burnt-in sand, our line offers the performance you need to get the job done fast. Tiger Ceramic sets a new standard for performance, delivering up to **30% faster cut-rate** compared to competitive zirconia cups. This faster material removal translates to better productivity in the cleaning room and less operator fatigue.

CUP FEATURES:

- Precision balanced to ensure smooth, **vibration-free operation** and reduced operator fatigue.
- Unique anchored safety nut locks the cup in place to **increase safety** and prevent product breakage.
- Zinc plated 5/8"-11 nut prevents oxidation, **eliminating contamination** and allows for easy spin-on, spin-off changeover.

APPLICATIONS:

Ideal for heavy metal removal, grinding, transitioning, rough beveling and removing cracks/flaws.



Type 11 Cup Rock for snagging and heavy stock removal.



RIM (W) WIDTH OPTIONS

1-1/2" RIM	Large grinding zone to minimize grind time
1" RIM	Medium grinding zone for maximum material removal in targeted areas
3/4" RIM	Ideal for targeted material removal in small, hard-to-access areas

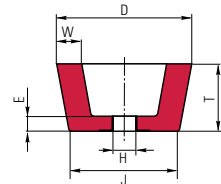

68400

NEW! MAX PERFORMANCE GRINDING

P	CAST IRON	DUCTILE IRON	CAST STEEL	HARD-TO-GRIND	TIGER CERAMIC / Superior Life & Cut				
	Diameter (D / J)	Thickness (T)	Arbor (H)	Rim (W)	Back (E)	Grade	Max. RPM	Std. Pack	Item #
	6" / 4-3/4"	2"	5/8"-11	1-1/2"	3/4"	HZA16Q	6,000	5	68400



68352

NEW! HIGH PERFORMANCE GRINDING

P	CAST IRON	DUCTILE IRON	CAST STEEL	TIGER ZIRC / Fast Cut & Long Life					
	Diameter (D / J)	Thickness (T)	Arbor (H)	Rim (W)	Back (E)	Grade	Max. RPM	Std. Pack	Item #
	4" / 3"	2"	5/8"-11	3/4"	3/4"	ZA16Q	9,070	5	68352
	5" / 3-3/4"	2"	5/8"-11	1"	3/4"	ZA16Q	7,260	5	68355
	6" / 4-3/4"	2"	5/8"-11	1"	3/4"	ZA16Q	6,000	5	68358
	6" / 4-3/4"	2"	5/8"-11	1-1/2"	3/4"	ZAC16Q	6,000	5	68361+
	6" / 4-3/4"	2"	5/8"-11	1-1/2"	3/4"	ZA16R	6,000	5	68362
	6" / 4-3/4"	2"	5/8"-11	1-1/2"	3/4"	ZA16Q	6,000	5	68364



68354

NEW! PERFORMANCE GRINDING

P	BURNT IN SAND	TIGER SiC / Long Life							
	Diameter (D / J)	Thickness (T)	Arbor (H)	Rim (W)	Back (E)	Grade	Max. RPM	Std. Pack	Item #
	4" / 3"	2"	5/8"-11	3/4"	3/4"	C16Q	9,070	5	68351
	5" / 3-3/4"	2"	5/8"-11	1"	3/4"	C16Q	7,260	5	68354
	6" / 4-3/4"	2"	5/8"-11	1"	3/4"	C16Q	6,000	5	68357
	6" / 4-3/4"	2"	5/8"-11	1-1/2"	3/4"	C16Q	6,000	5	68069



68356

P	CAST IRON	TIGER AO / Long Life							
	Diameter (D / J)	Thickness (T)	Arbor (H)	Rim (W)	Back (E)	Grade	Max. RPM	Std. Pack	Item #
	4" / 3"	2"	5/8"-11	3/4"	3/4"	A16Q	9,070	5	68350
	5" / 3-3/4"	2"	5/8"-11	1"	3/4"	A16Q	7,260	5	68353
	6" / 4-3/4"	2"	5/8"-11	1"	3/4"	A16Q	6,000	5	68356
	6" / 4-3/4"	2"	5/8"-11	1-1/2"	3/4"	A16Q	6,000	5	68359
	6" / 4-3/4"	2"	5/8"-11	1-1/2"	3/4"	AC16Q	6,000	5	68360+

+ Includes silicon carbide for burnt-in sand and hard-to-grind metals.

FLARING CUP WHEEL MOUNTING FLANGE

Fits over 5/8"-11 spindles

Diameter	Thickness	Std. Pack	Item #
2"	1/4"	1	73054



73054

SAFETY WARNING: Using a flaring cup wheel without the proper flange is a violation of ANSI code.



For Right Angle Grinders

TYPE 27 GRINDING WHEELS



Riser removal with a type 27 grinding wheel.

Weiler Tiger type 27 grinding wheels deliver the next evolution in technology for portable foundry grinding. The line is available in three performance tiers, including Tiger Ceramic which sets a new standard for maximum performance. The ceramic grain leverages an engineered ultra-fine microstructure that self-sharpenes for ultra-fast grinding. This technology allows Tiger Ceramic to remove up to **40% more material** over the life of the wheel compared to competitive zirconia products. This translates to better productivity in the cleaning room and a reduction in abrasives usage.

GRINDING WHEEL FEATURES:

- Advanced anti-chipping technology **improves safety** through the reduction of high energy debris emitted during the grinding process.
- 5/8"-11 nipped metal hub allows for **quick spin-on, spin-off changeover** and eliminates cross-threading or sticking to spindle due to heat build-up.
- Triple fiberglass reinforcement for **added strength**.
- 1/8" combo wheels offer **flexibility and efficiency** when switching between cutting and grinding applications.

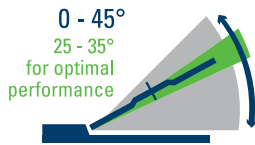

1/4" GRINDING WHEELS:

Ideal for heavy stock removal, removing cracks and surface imperfections, blending parting lines, removing flash, gate and riser removal.

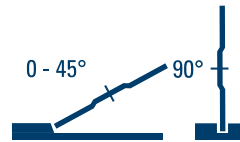

1/8" COMBO WHEELS:

Ideal for light grinding, blending parting lines, removing flash and cutting gates and risers.

NEW!

MAX PERFORMANCE

TIGER CERAMIC / Superior Cut & Long Life

P

CAST IRON DUCTILE IRON CAST STEEL HARD-TO-GRIND

TYPE 27
7/8" Arbor

TYPE 27
5/8"-11 Hub

Diameter	Thickness	Grade	Max. RPM	Std. Pack	Item #	Std. Pack	Item #
Type 27 Depressed Center 1/4" Grinding Wheels							
7"	1/4"	CER24T	8,500	10	68388	10	68389
9"	1/4"	CER24T	6,600	10	68392	10	68393
Type 27 Depressed Center 1/8" Cut & Grind Combo Wheels							
7"	1/8"	CER30T	8,500	25	68386	10	68387
9"	1/8"	CER30T	6,600	25	68390	10	68391



68389

NEW!

HIGH PERFORMANCE

TIGER ZIRC / Fast Cut & Long Life

P

CAST IRON DUCTILE IRON CAST STEEL

TYPE 27
7/8" Arbor

TYPE 27
5/8"-11 Hub

Diameter	Thickness	Grade	Max. RPM	Std. Pack	Item #	Std. Pack	Item #
Type 27 Depressed Center 1/4" Grinding Wheels							
7"	1/4"	Z24T	8,500	10	68380	10	68381
9"	1/4"	Z24T	6,600	10	68384	10	68385
Type 27 Depressed Center 1/8" Cut & Grind Combo Wheels							
7"	1/8"	Z30T	8,500	25	68378	10	68379
9"	1/8"	Z30T	6,600	25	68382	10	68383



68380

NEW!

PERFORMANCE

TIGER AO / Long Life

P

CAST IRON

TYPE 27
7/8" Arbor

TYPE 27
5/8"-11 Hub

Diameter	Thickness	Grade	Max. RPM	Std. Pack	Item #	Std. Pack	Item #
Type 27 Depressed Center 1/4" Grinding Wheels							
7"	1/4"	A24T	8,500	10	68372	10	68373
9"	1/4"	A24T	6,600	10	68376	10	68377
Type 27 Depressed Center 1/8" Cut & Grind Combo Wheels							
7"	1/8"	A30T	8,500	25	68370	10	68371
9"	1/8"	A30T	6,600	25	68374	10	68375



68370

BONDED ABRASIVES

COATED ABRASIVES

NON-WOVEN ABRASIVES

POWER BRUSHES

NYLON BRUSHES

PACKAGED ITEMS

MAINTENANCE



Weiler Tiger cones and plugs offer performance grinding solutions for ID cleaning, hole edge beveling, smoothing weld seams, removing parting lines and cleaning castings in hard-to-reach places. Designed with the operator in mind, these abrasives provide smooth, vibration free operation and instant cutting action right out of the box.



Using a cone to clean surface imperfections.

CONE & PLUG FEATURES:

- Open face design provides **aggressive cut-rate** right out of the box.
- Anchored hexagon nut secures the abrasive to the tool to **increase safety** and prevent product breakage.
- Zinc plated nut prevents oxidation, **eliminates contamination** and allows for easy mounting.
- Precision balanced to ensure smooth, **vibration free operation** and reduced operator fatigue.

APPLICATIONS:

Ideal for ID cleaning, hole edge beveling, smoothing weld seams, removing parting lines and cleaning castings in hard-to-reach places.

COMING IN
SPRING, 2022

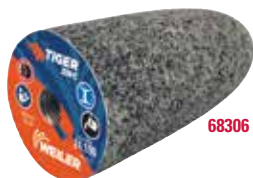
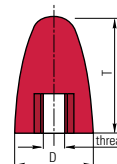
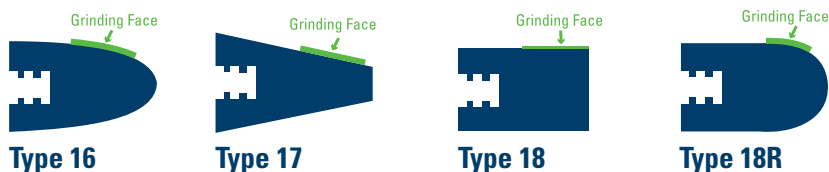

NEW! MAX PERFORMANCE GRINDING

CAST IRON DUCTILE IRON CAST STEEL HARD-TO-GRIND

P TIGER CERAMIC TYPE 16 CONES / Superior Life & Cut

Diameter (D)	Thickness (T)	Arbor (Thread)	Grade	Max. RPM	Std. Pack	Item #
2"	3"	5/8"-11 Nut	HZA20S	18,145	12	68403

NEW! HIGH PERFORMANCE GRINDING

CAST IRON DUCTILE IRON CAST STEEL TIGER ZIRC TYPE 16 CONES / Fast Cut & Long Life

Diameter (D)	Thickness (T)	Arbor (Thread)	Grade	Max. RPM	Std. Pack	Item #
1"	3"	3/8"-24 Nut	ZA20S	36,290	12	68301
1-1/2"	2-1/2"	5/8"-11 Nut	ZA20S	24,190	12	68304
1-1/2"	2"	3/8"-24 Nut	ZA20S	24,190	12	68306
1-1/2"	3"	5/8"-11 Nut	ZA20S	24,190	12	68308
2"	3"	5/8"-11 Nut	ZA20S	18,145	12	68311
2-3/4"	3-1/2"	5/8"-11 Nut	ZA20S	13,195	12	68313

NEW! PERFORMANCE GRINDING

CAST IRON TIGER A0 TYPE 16 CONES / Long Life

Diameter (D)	Thickness (T)	Arbor (Thread)	Grade	Max. RPM	Std. Pack	Item #
1"	3"	3/8"-24 Nut	A24R	36,290	12	68300
1-1/2"	2-1/2"	3/8"-24 Nut	A24R	24,190	12	68302
1-1/2"	2-1/2"	5/8"-11 Nut	A24R	24,190	12	68303
1-1/2"	3"	3/8"-24 Nut	A24R	24,190	12	68305
1-1/2"	3"	5/8"-11 Nut	A24R	24,190	12	68307
2"	3"	3/8"-24 Nut	A24R	18,145	12	68309
2"	3"	5/8"-11 Nut	A24R	18,145	12	68310
2-3/4"	3"	5/8"-11 Nut	A24R	13,195	12	68312
3"	3"	5/8"-11 Nut	A24R	12,100	12	68314

ANCHORED NUT INCREASES SAFETY

- Heavy-duty steel hex nut fully anchored into abrasive bond prevents separation and slippage during use.

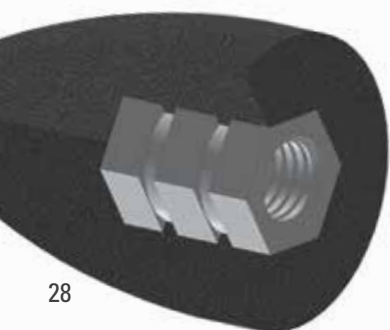

NEW! MAX PERFORMANCE GRINDING

P CAST IRON DUCTILE IRON CAST STEEL HARD-TO-GRIND
TIGER CERAMIC TYPE 17 CONES / Superior Life & Cut

Diameter (D)	Thickness (T)	Arbor (Thread)	Grade	Max. RPM	Std. Pack	Item #
2"	3"	5/8"-11 Nut	HZA20S	18,145	12	68404

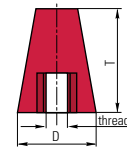

NEW! HIGH PERFORMANCE GRINDING

P CAST IRON DUCTILE IRON CAST STEEL **TIGER ZIRC TYPE 17 CONES** / Fast Cut & Long Life

Diameter (D)	Thickness (T)	Arbor (Thread)	Grade	Max. RPM	Std. Pack	Item #
2"	3"	5/8"-11 Nut	ZA20S	18,145	12	68365



NEW! PERFORMANCE GRINDING

P CAST IRON **TIGER AO TYPE 17 CONES** / Long Life

Diameter (D)	Thickness (T)	Arbor (Thread)	Grade	Max. RPM	Std. Pack	Item #
1-1/2"	3"	3/8"-24 Nut	A24R	24,190	12	68315
1-3/4"	3"	5/8"-11 Nut	A24R	20,740	12	68316
2"	3"	5/8"-11 Nut	A24R	18,145	12	68317

NEW! MAX PERFORMANCE GRINDING

P CAST IRON DUCTILE IRON CAST STEEL HARD-TO-GRIND
TIGER CERAMIC TYPE 18 PLUGS / Superior Life & Cut

Diameter (D)	Thickness (T)	Arbor (Thread)	Grade	Max. RPM	Std. Pack	Item #
2"	3"	5/8"-11 Nut	HZA20S	18,145	12	68405

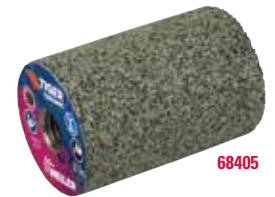
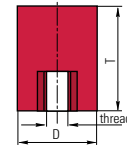

NEW! HIGH PERFORMANCE GRINDING

P CAST IRON DUCTILE IRON CAST STEEL **TIGER ZIRC TYPE 18 PLUGS** / Fast Cut & Long Life

Diameter (D)	Thickness (T)	Arbor (Thread)	Grade	Max. RPM	Std. Pack	Item #
1-1/2"	2-1/2"	5/8"-11 Nut	ZA20S	24,190	12	68320
1-1/2"	3"	5/8"-11 Nut	ZA20S	24,190	12	68322
2"	3"	5/8"-11 Nut	ZA20S	18,145	12	68324

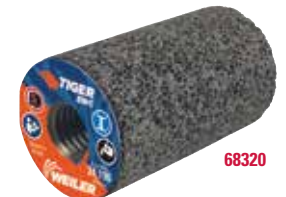

NEW! PERFORMANCE GRINDING

P CAST IRON **TIGER AO TYPE 18 PLUGS** / Long Life

Diameter (D)	Thickness (T)	Arbor (Thread)	Grade	Max. RPM	Std. Pack	Item #
1-1/2"	2-1/2"	3/8"-24 Nut	A24R	24,190	12	68318
1-1/2"	2-1/2"	5/8"-11 Nut	A24R	24,190	12	68319
1-1/2"	3"	5/8"-11 Nut	A24R	24,190	12	68321
2"	3"	5/8"-11 Nut	A24R	18,145	12	68323

NEW! MAX PERFORMANCE GRINDING

P CAST IRON DUCTILE IRON CAST STEEL HARD-TO-GRIND
TIGER CERAMIC TYPE 18R PLUGS / Superior Life & Cut

Diameter (D)	Thickness (T)	Arbor (Thread)	Grade	Max. RPM	Std. Pack	Item #
2"	3"	5/8"-11 Nut	HZA20S	18,145	12	68406

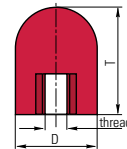

NEW! HIGH PERFORMANCE GRINDING

P CAST IRON DUCTILE IRON CAST STEEL **TIGER ZIRC TYPE 18R PLUGS** / Fast Cut & Long Life

Diameter (D)	Thickness (T)	Arbor (Thread)	Grade	Max. RPM	Std. Pack	Item #
1-1/2"	3"	3/8"-24 Nut	ZA20S	24,190	12	68326
1-1/2"	3"	5/8"-11 Nut	ZA20S	24,190	12	68328
2"	3"	5/8"-11 Nut	ZA20S	18,145	12	68330



NEW! PERFORMANCE GRINDING

P CAST IRON **TIGER AO TYPE 18R PLUGS** / Long Life

Diameter (D)	Thickness (T)	Arbor (Thread)	Grade	Max. RPM	Std. Pack	Item #
1-1/2"	3"	3/8"-24 Nut	A24R	24,190	12	68325
1-1/2"	3"	5/8"-11 Nut	A24R	24,190	12	68327
2"	3"	5/8"-11 Nut	A24R	18,145	12	68329
3"	3"	5/8"-11 Nut	A24R	12,100	12	68331

SNAGGING WHEELS - FOR FOUNDRY

For Pneumatic & High Frequency
Electric Straight Grinders & Die Grinders



Weiler Tiger type 1 portable snagging wheels feature a flat face with a narrow contact area, making them ideal for heavy grinding, transitioning, rough beveling, and removing cracks and flaws. The line is available in three performance tiers, including Tiger Zirc, which provides an excellent combination of long product life and a fast, consistent cut-rate when grinding.

Tiger 6 & 8 inch snagging wheels are designed for medium to high power pneumatic and high frequency electric straight grinders, while the 3 inch wheels are used on die grinders. The arbor hole is produced with a precision phenolic resin insert to ensure a tight fit on the tool, minimizing vibration and enhancing the operator experience.

FEATURES:

- Open face design provides **aggressive cut-rate** right out of the box.
- Precision balanced to ensure smooth, **vibration-free operation** and reduced operator fatigue.
- Double fiberglass internal reinforcement in 6 & 8 inch wheels provide **added strength** for consistent product wear and reduced edge chipping.

APPLICATIONS:

Ideal for snagging, grinding, heavy stock removal, transitioning, rough beveling, removing cracks and flaws, blending parting lines and deflashing.



Portable snagging wheels are ideal for targeted heavy stock removal applications.

COMING IN
SPRING, 2022

Type 1 (Flat)



Features a flat face with narrow contact area



68402



68342



68340

NEW! MAX PERFORMANCE SNAGGING

P CAST IRON DUCTILE IRON TIGER CERAMIC
CAST STEEL HARD-TO-GRIND Superior Life & Cut

TYPE 1
5/8" Arbor

Diameter	Thickness	Grade	Max. RPM	Std. Pack	Item #
6"	1"	HZR16-R	8,000	5	68401
8"	1"	HZR16-R	6,000	5	68402

NEW! HIGH PERFORMANCE SNAGGING

P CAST IRON DUCTILE IRON TIGER ZIRC
CAST STEEL Fast Cut & Long Life

TYPE 1
3/8" Arbor

TYPE 1
5/8" Arbor

Diameter	Thickness	Grade	Max. RPM	Std. Pack	Item #	Std. Pack	Item #
3"	1/2"	ZA14S	18,080	10	68341	—	—
6"	1"	ZA16Q	8,000	—	—	5	68342
6"	1"	ZAC16Q	8,000	—	—	5	68343+
6"	1"	ZA16R	8,000	—	—	5	68344
8"	1"	ZA16O	6,000	—	—	5	68345
8"	1"	ZA16Q	6,000	—	—	5	68346
8"	1"	ZAC16Q	6,000	—	—	5	68347+
8"	1"	ZA16R	6,000	—	—	5	68348
8"	1"	ZA16T	6,000	—	—	5	68349

+ Includes silicon carbide for burnt-in sand and hard-to-grind metals.

NEW! PERFORMANCE GRINDING

P CAST IRON TIGER AO / Long Life

TYPE 1
3/8" Arbor

Diameter	Thickness	Grade	Max. RPM	Std. Pack	Item #
3"	1/2"	A14P	18,080	10	68340



Weiler Tiger Zirc mounted points come in various ANSI point shapes including A1, A11, A3, and W. A zirconia abrasive grain in combination with a strong bond delivers long product life and a consistent cut rate when grinding metal. The unique shapes allow for precise cleaning and grinding of parts with complex geometries and in hard-to-reach areas. Designed for die grinders, mounted points have a standard 1/4" shank diameter and a 1-1/2" shank length.

FEATURES:

- Dressed working surface **eliminates break-in** and provides a consistent finish.
- Engineered stem bonding adds **strength and stability** to the point, improving safety.
- Tailored product geometry provides **optimal control** for precise grinding of critical parts.

APPLICATIONS:

Ideal for cleaning ID's, corners and hard-to-reach areas, edge chamfering, light grinding, stock removal and hole edge beveling.



Tiger mounted points are ideal for light grinding in hard-to-reach areas and removing cracks from castings.

**COMING IN
SPRING, 2022**

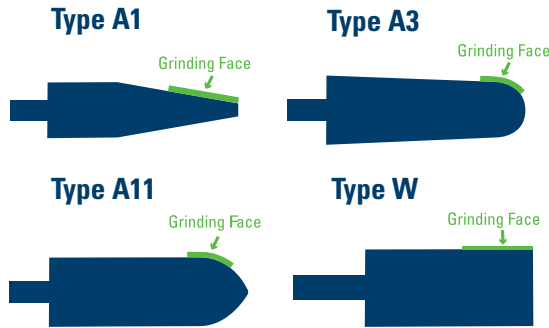

NEW! HIGH PERFORMANCE GRINDING

CAST IRON DUCTILE IRON CAST STEEL

P

TIGER ZIRC / Fast Cut & Long Life

Diameter	Length	Shape	Grade	Max. RPM	Std. Pack	Item #
3/4"	1/2"	A1	RZA24U	19,800	10	68332
7/8"	2"	A11	RZA24U	19,860	10	68333
1"	2-3/4"	A3	RZA24U	16,100	10	68334
1/2"	2"	W189	RZA24U	24,000	10	68335
3/4"	1-1/2"	W207	RZA24U	24,000	10	68336
3/4"	2"	W208	RZA24U	18,750	10	68337
1"	1-1/2"	W221	RZA24U	19,120	10	68338
1"	2"	W222	RZA24U	15,900	10	68339
5/8"	2"	W197	RZA24U	21,000	10	68366



COATED ABRASIVES
NON-WOVEN ABRASIVES
POWER BRUSHES
NYLOX BRUSHES
PACKAGED ITEMS
MAINTENANCE





WEILER WAS FIRST

From the company that brought flap discs to the US, Weiler coated abrasive products continue to set the standard. Our Premium Tiger® flap discs are engineered to conquer any material or application.

Weiler recently expanded its Flap Disc line. Weiler Tiger Aluminum discs offer a paired flap design that delivers high performance grinding on aluminum. The top flaps have a calcium stearate coating that eliminates loading and allows the disc to maintain a high cut-rate, while the alternating flaps aggressively remove material with self-sharpening zirconia aluminum grains.

Technical Information	36-37
Flap Discs	38-43
Resin Fiber Discs	44-47
Blending Discs	48
Trim-Kut® Discs	49
Flap Wheels	50-51
Shop Rolls	52

COATED ABRASIVES

SOLUTIONS SHOWCASE

STEEL PIPING

Problem: A clean bevel end free of any surface imperfections is critical to a strong joint when welding heavy-wall piping. Unfortunately, lengths of steel pipe can sit in yards for significant periods of time, and pitting of the bevel ends is usually the result.

Solution: Coated abrasive flap discs like Weiler's original Tiger Disc are ideal tools for quickly removing heavy corrosion and blending pitting from bevel ends. The chatter-free, compliant grinding action and smooth, consistent finish produced by these discs make them the preferred choice for this application.

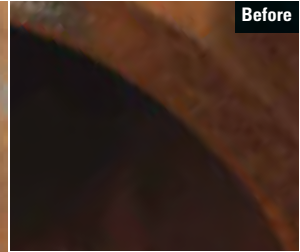

STEEL CHANNEL

Problem: Burrs produced by cut-off operations are dangerous and can prevent parts from fitting together properly, which can cause potential structural weak points.

Solution: Weiler's coated abrasive flap wheels are flexible grinding products that are ideal for light stock removal applications. A 60 grit wheel can be used to remove a large burr and produce a smooth blended edge.



ALUMINUM FRAMES

Problem: Aluminum welds are particularly difficult to blend due to the tendency of the chips to become welded to the abrasive media. This causes the cut rate of the abrasive to fall rapidly and generates an expensive grinding operation.

Solution: Weiler's Tiger® Aluminum discs are specially formulated to prevent loading by lowering the grinding temperature. A 60 grit disc can blend an aluminum weld bead much faster than a conventional disc without loading.



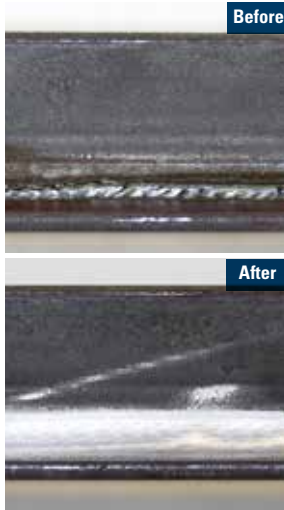

STRUCTURAL STEEL BEAM

Problem: Grinding fillet welds is a difficult, time-consuming process that is often expensive to perform.

Solution: Tiger Angled flap discs are a great option for the metalworking professional looking for more versatility than a traditional flap disc can offer and ready to go to work right out of the box. They are ideal for applications that previously required either a carbide burr or trimmable flap disc in order to access welds. Tiger Angled also provides versatility in repair and re-work applications, where it is important to focus grinding in a small area while minimizing impact to the surrounding work piece(s).

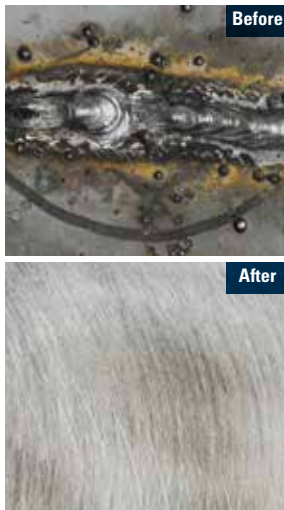

TANK AND PRESSURE VESSEL

Problem: The welds inside tanks and pressure vessels must be blended smooth prior to x-ray and pressure testing.

Solution: Weiler's Big Cat® High Density flap discs have the largest flap area in the industry – 22% more cloth. The result is enhanced conformability on curved or irregular surfaces and up to 40% longer life.

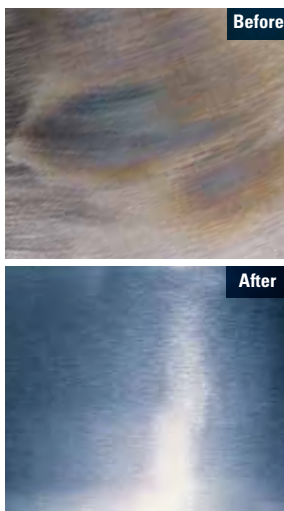

STEEL RACK BRACES

Problem: To prevent weldments used in the construction of offshore oil platforms from "racking" under load, lengths of steel bar stock are added as braces during the fabrication of these structural members. Beveling or chamfering the ends of the bars increases weld penetration and strengthens the joint.

Solution: The requirement for fast stock removal and long wheel life makes this an ideal application for a good quality Type 27 grinding wheel like those in Weiler's Vortec Pro® line of general-purpose bonded abrasives.

SELECTING THE RIGHT FLAP DISC

Weiler's abrasive flap discs grind and finish in one step, saving you time and money. There's no switching from a type 27 grinding wheel to a resin fiber disc.



P MAX PERFORMANCE	TIGER® CERAMIC <ul style="list-style-type: none"> • TOP COAT for cool grinding • Protects from heat discoloration • Prevents loading on soft alloys 	GRAIN TYPE Ceramic alumina CONTAMINANT FREE CONTAIN LESS THAN 0.1% IRON, SULFUR & CHLORINE	STYLES  	BEST ON STEEL / METAL ALUMINUM STAINLESS HARD-TO-GRIND (Hard-to-grind metals include tool steel, inconel, high nickel alloy, titanium and armored steel)
P HIGH PERFORMANCE	TIGER X <ul style="list-style-type: none"> • FLAT SURFACE GRINDING • Less effort required • Fast grinding & long life 	GRAIN TYPE Ceramic & zirconia alumina CONTAMINANT FREE CONTAIN LESS THAN 0.1% IRON, SULFUR & CHLORINE	STYLES    *Big Cat	BEST ON STEEL / METAL STAINLESS (Metal includes structural steel and cast iron)
P PERFORMANCE	TIGER PAW <ul style="list-style-type: none"> • SUPERIOR EDGE GRINDING • Aggressive stock removal 	GRAIN TYPE 100% zirconia alumina CONTAMINANT FREE CONTAIN LESS THAN 0.1% IRON, SULFUR & CHLORINE	STYLES    	BEST ON STEEL / METAL STAINLESS (Metal includes structural steel and cast iron)
V VALUE	WOLVERINE® <ul style="list-style-type: none"> • Fast stock removal • Consistent performance 	GRAIN TYPE Zirconia alumina	STYLES   	BEST ON STEEL / METAL

*Big Cat is a zirconia alumina flap disc and does not contain any ceramic alumina.

SPECIALTY FLAP DISCS

	 MAX PERFORMANCE	 HIGH PERFORMANCE	 PERFORMANCE
ANGLED (Fillet Welds) 	<input checked="" type="checkbox"/>	<input checked="" type="checkbox"/>	
TRIMMABLE (Non-Marking) 	<input checked="" type="checkbox"/>	<input checked="" type="checkbox"/>	
ALUMINUM BACK (Rigid Support) 		<input checked="" type="checkbox"/>	
ALUMINUM (Non-Loading) 		<input checked="" type="checkbox"/>	
MINI (Tight Spaces) 			<input checked="" type="checkbox"/> (Bobcat)

STYLE



CONICAL (Type 29)
15° – 35°



Angled flaps maximize surface contact for aggressive stock removal on flat surfaces.



FLAT (Type 27)
0° – 15°



Smooth grinding, blending and finishing on flat surfaces and slight contours.



HIGH DENSITY (Type 27)
0° – 15°



Conformable to irregular surfaces. Smooth grinding, blending and finishing on flat surfaces.



ANGLED (Type 27 / Hybrid)
0° – 35°



Curved flaps for grinding fillet welds, T-joints and hard-to-reach areas.

GRIT

Coarse Grit

36

40

60

80

Fine Grit

120

HEAVY STOCK REMOVAL

EDGE BEVELING / CHAMFERING

WELD GRINDING / BLENDING

DEBURR / DEFLASH

RUST REMOVAL / BLENDING

CLEANING / FINISHING

GRAIN



CERAMIC ALUMINA (CA)

- Self-sharpening micro fracturing crystals expose sharp edges
- Maintains a high cut-rate for the life of the grain
- Longest cutting life under moderate to high pressure
- Exceptional performance on hard-to-grind metals



ZIRCONIA ALUMINA (ZA)

- Self-sharpening crystals
- Holds up under high temperatures and extreme pressure
- Sharp, fast cutting, long lasting grain



ALUMINUM OXIDE (AO)

- Single crystal that dulls during use
- Good initial cut rate
- Hard, durable grain

BACKING

PHENOLIC



Prevents backing from scratching the workpiece.

ALUMINUM



Rigid support for maximum aggression; recyclable.

COMPOSITE*



Trimmable, non-marking backing; allows access to hard-to-reach areas.

*BobCat™ Discs are not Trimmable.

ARBOR

5/8" - 11 NUT

- Quick change over
- Eliminates cross-threading experienced with plastic backs
- Metal nut eliminates the disc from sticking to the grinder due to heat build up



OPEN ARBOR

- Requires adapting nuts
- 5/8" option for 4" grinders
- 7/8" option for 4-1/2" and larger grinders



MOUNTING DISCS WITH OPEN ARBORS



- Adapting Nut
- Abrasive Flap Disc
- Adapting Nut
- Right Angle Grinder

MANDRELS & METAL HUB PADS

- For quick-change on tools with 1/4" collets

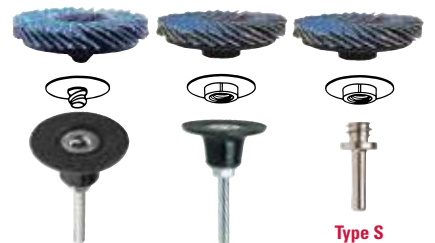

Type R hub pad + mandrel

Type S hub pad + mandrel

Type S mandrel

STANDARD DENSITY FLAP DISCS



MADE IN USA
WITH GLOBAL MATERIALS



Grinding & blending a weld between two Steel plates.

Weiler's Tiger discs are engineered to maximize productivity and minimize operating costs for professionals who demand more. Get the right flap disc for your application and **get more done with Tiger.**

P MAX PERFORMANCE / TIGER® CERAMIC (SABER TOOTH)

Top Coated for Cool Grinding / Ceramic Alumina / Phenolic Back / **Contaminant-free***

STEEL / METAL	STAINLESS	HARD-TO-GRIND	ALUMINUM	TYPE 29	
				7/8" Arbor	5/8"-11 Hub
Diameter	Grit	Max. RPM	Std. Pack	Item #	Item #
4-1/2"	36	13,000	10	50100	50104♦
	40			50101	50105♦
	60			50102	50106♦
	80			50103	50107♦
5"	40	12,000	10	50538 •	—
	60			50539 •	—
	80			50540 •	—
7"	36	8,600	10	50108	50112♦
	40			50109	50113♦
	60			50110	50114♦
	80			50111	50115♦

• Non-stock product, contact Customer Service for lead times and minimum order quantities.



50106

P HIGH PERFORMANCE / TIGER X

Fast Grinding & Long Life on Flat Surfaces / Ceramic & Zirconia Alumina / Phenolic Back / **Contaminant-free***

STEEL / METAL	STAINLESS	TYPE 29		TYPE 27			
		7/8" Arbor	5/8"-11 Hub	7/8" Arbor	5/8"-11 Hub		
Diameter	Grit	Max. RPM	Std. Pack	Item #	Item #	Item #	Item #
4-1/2"	36	13,000	10	51200	51204♦	—	—
	40			51201	51205♦	51223	51226♦
	60			51202	51206♦	51224	51227♦
	80			51203	51207♦	51225	51228♦
	—			—	—	—	—
5"	36	12,000	10	51208	—	—	—
	40			51209	51212♦	—	—
	60			51210	51213♦	—	—
	80			51211	51214♦	—	—
	—			—	—	—	—
6"	40	10,200	10	51237	51241♦	—	—
	60			51238	51242♦	—	—
	80			51239 •	51243♦ •	—	—
	—			—	—	—	—
7"	36	8,600	10	51215	51219♦	—	—
	40			51216	51220♦	51229	51232♦
	60			51217	51221♦	51230	51233♦
	80			51218	51222♦	51231	51234♦
	—			—	—	—	—



51205

P PERFORMANCE / ORIGINAL TIGER

High cut rate & long life / Zirconia Alumina / Phenolic Back / **Contaminant-free***

STEEL / METAL	STAINLESS	TYPE 29		TYPE 29		TYPE 29		TYPE 27	
		5/8" Arbor	7/8" Arbor	5/8"-11 Hub	5/8" Arbor	7/8" Arbor	5/8"-11 Hub		
Dia.	Grit	Max. RPM	Std. Pack	Item #	Item #	Item #	Item #	Item #	Item #
4"	36	15,000	10	50592	—	—	—	—	—
	40			50593	—	—	50693	—	—
	60			50594	—	—	50694	—	—
	80			50595	—	—	50695	—	—
	120			—	—	—	50696	—	—
4-1/2"	24	13,000	10	—	50601	—	—	—	—
	120			—	50606	—	—	50706	50699♦
5"	40	12,000	10	—	—	—	—	50713	—
	60			—	—	—	—	50714	—
	80			—	—	—	—	50715	—
	120			—	50616	—	—	—	—
6"	40	10,200	10	—	50649	50659♦	—	—	—
	60			—	50650	50660♦	—	—	—
	80			—	50651	50661♦	—	—	—
7"	120	8,600	10	—	—	—	—	50746♦ •	



50601

• Non-stock product, contact Customer Service for lead times and minimum order quantities.

♦ Patent # 6,945,863

*Contaminant-free (Contains less than 0.1% Fe, S, Cl)

P

PERFORMANCE / TIGER PAW™

Aggressive Stock Removal for Edge Grinding / 100% Zirconia Alumina / Phenolic Back / Contaminant-free*

STEEL / METAL	STAINLESS			TYPE 29	TYPE 29	TYPE 29	TYPE 27	TYPE 27	TYPE 27
		Max. RPM	Std. Pack	5/8" Arbor	7/8" Arbor	5/8"-11 Hub	5/8" Arbor	7/8" Arbor	5/8"-11 Hub
Dia.	Grit			Item #	Item #	Item #	Item #	Item #	Item #
4"	40	15,000	10	51104	-	-	51101	-	-
	60			51105	-	-	51102	-	-
4-1/2"	36	13,000	10	-	51118	51123♦	-	51107	51112♦
	40			-	51119	51124♦	-	51108	51113♦
	60			-	51120	51125♦	-	51109	51114♦
	80			-	51121	51126♦	-	51110	51115♦
5"	36	12,000	10	-	51128	51153♦	-	51182	51155♦
	40			-	51129	51132♦	-	51134	51156♦
	60			-	51130	51133♦	-	51135	51157♦
	80			-	51131	51154♦	-	51183	51158♦
6"	40	10,200	10	-	51175	51179♦	-	-	-
	60			-	51176	51180♦	-	-	-
	80			-	51177•	51181♦•	-	-	-
	-			-	-	-	-	-	-
7"	36	8,600	10	-	-	51149♦	-	-	51139♦
	40			-	51145	51146♦	-	51137	51140♦
	60			-	51150	51147♦	-	51138	51142♦
	80			-	-	51148♦	-	-	51143♦



51126

51140

V

WOLVERINE®

Consistent Performance / Zirconia Alumina / Phenolic Back

STEEL / METAL			TYPE 29	TYPE 29	TYPE 29	TYPE 27	TYPE 27	
	Max. RPM	Std. Pack	5/8" Arbor	7/8" Arbor	5/8"-11 Hub	7/8" Arbor	5/8"-11 Hub	
Dia.	Grit		Item #	Item #	Item #	Item #	Item #	
4"	36	15,000	10	31337	-	-	-	-
	40			31338	-	-	-	-
	60			31339	-	-	-	-
	80			31340	-	-	-	-
4-1/2"	36	13,000	10	-	31343	31349♦	31401	31407♦
	40			-	31344	31350♦	31402	31408♦
	60			-	31345	31351♦	31403	31409♦
	80			-	31346	31352♦	31404	31410♦
	120			-	31347	31353♦	31405	-
5"	36	12,000	10	-	31355	-	-	-
	40			-	31356	-	-	-
	60			-	31357	-	-	-
	80			-	31358	-	-	-
6"	40	10,200	10	-	31447•	31451♦•	-	-
	60			-	31448•	31452♦•	-	-
	80			-	31449•	31453♦•	-	-
	-			-	-	-	-	-
7"	36	8,600	10	-	31361	31367♦	-	31419♦
	40			-	31362	31368♦	31414	31420♦
	60			-	31363	31369♦	31415	31421♦
	80			-	31364	31370♦	-	31422♦



31338

31343

Key:

P PERFORMANCE LINE Industrial Grade

V VALUE LINE Professional Grade

• Non-stock product, contact Customer Service for lead times and minimum order quantities.
♦ Patent # 6,945,863 *Contaminant-free (Contains less than 0.1% Fe, S, Cl)

WHY WEILER
BONDED ABRASIVES
COATED ABRASIVES
NON-WOVEN ABRASIVES
POWER BRUSHES
NYLON BRUSHES
PACKAGED ITEMS
MAINTENANCE

HIGH DENSITY FLAP DISCS



High density flap discs last up to 40% longer than standard density. They are ideal for grinding and blending uneven or irregular surfaces.

MADE IN USA
WITH GLOBAL MATERIALS



Blending and finishing a weld with a Big Cat flap disc.



INDUSTRY-LEADING FOOTPRINT

30mm flaps on Big Cat and Tiger Paw Type 27 Style flap discs increases surface area grinding



50134

P MAX PERFORMANCE / TIGER® CERAMIC HD (SABER TOOTH)

Top Coated for Cool Grinding on Irregular Surfaces / Ceramic Alumina / Phenolic Back / Contaminant-free*

STEEL / METAL STAINLESS HARD-TO-GRIND ALUMINUM

Diameter	Grit	Max. RPM	Std. Pack	TYPE 27	
				7/8" Arbor	5/8"-11 Hub
				Item #	Item #
4-1/2"	40	12,000	10	50130	50133♦
	60			50131	50134♦
	80			50132	50135♦
7"	40	8,600	10	50136	50139♦
	60			50137	50140♦
	80			50138	50141♦



50804

P HIGH PERFORMANCE / TIGER BIG CAT® HD

Fast Grinding & Long Life on Irregular Surfaces / Zirconia Alumina / Phenolic Back / Contaminant-free*

STEEL / METAL STAINLESS

Diameter	Grit	Max. RPM	Std. Pack	TYPE 27	
				7/8" Arbor	5/8"-11 Hub
				Item #	Item #
4-1/2"	40	12,000	10	50803	50808♦
	60			50804	50809♦
	80			50805	50810♦
	120			50806	-
7"	40	8,600	10	50823	50843♦
	60			50824	50844♦
	80			50825	50845♦
	120			-	50846♦



51165

P PERFORMANCE / TIGER PAW™ HD

Aggressive Stock Removal on Irregular Surfaces
100% Zirconia Alumina / Phenolic Back / Contaminant-free*

STEEL / METAL STAINLESS

Diameter	Grit	Max. RPM	Std. Pack	TYPE 29		TYPE 27	
				7/8" Arbor	5/8"-11 Hub	7/8" Arbor	5/8"-11 Hub
				Item #	Item #	Item #	Item #
4-1/2"	36	12,000	10	51060♦	51064♦	51160	51164♦
	40			51061	51065♦	51161	51165♦
	60			51062♦	51066♦	51162	51166♦
	80			51063♦	51067♦	51163	51167♦
5"	40	12,000	10	-	-	51195♦	-
	60			-	-	51196♦	-
	80			-	-	51197♦	-
6"	40	10,200	10	-	-	51199♦	51187♦
	60			-	-	51184♦	51188♦
	80			-	-	51185♦	51189♦
7"	40	8,600	10	-	-	51170	51168♦
	60			-	-	51171	51169♦



31388

V WOLVERINE® HD

Consistent Performance on Irregular Surfaces / Zirconia Alumina / Phenolic Back

STEEL / METAL

Diameter	Grit	Max. RPM	Std. Pack	TYPE 27	
				7/8" Arbor	5/8"-11 Hub
				Item #	Item #
4-1/2"	40	12,000	10	31387	31390♦
	60			31388	31391♦
	80			31389	31392♦
6"	40	10,200	10	31439♦	31443♦
	60			31440♦	31444♦
	80			31441♦	31445♦

* Non-stock product, contact Customer Service for lead times and minimum order quantities.

♦ Patent # 6,945,863

*Contaminant-free (Contains less than 0.1% Fe, S, Cl)



ALUMINUM BACK

Aluminum backed flap discs are ideal for demanding applications that require extra strength and rigid support. The aluminum backing plate is also 100% recyclable.

MADE IN
USA
WITH GLOBAL
MATERIALS



Chamfering an aluminum extrusion preparing for weld

P HIGH PERFORMANCE / TIGER® ALUMINUM BACK

Fast Grinding & Long Life / Zirconia Alumina / Backing Plate Provides Rigid Support / **Contaminant-free***

STEEL / METAL	STAINLESS	Diameter	Grit	Max. RPM	Std. Pack	TYPE 29	TYPE 29	TYPE 29
						5/8" Arbor	7/8" Arbor	5/8"-11 Hub
						Item #	Item #	Item #
		4"	36	15,000	10	50502	-	-
			40			50503	-	-
			60			50504	-	-
			80			50505	-	-
			120			50506	-	-
		4-1/2"	24	13,000	10	-	50511	50510
			36			50512	50517	
			40			50513	50518	
			60			50514	50519	
			80			50515	50520	
		5"	36	12,000	10	-	50522	-
			40			50523	-	
			60			50524	-	
			80			50525	-	
			120			50526	-	
		7"	24	8,600	10	-	-	50541
			36			50532 •	50542	
			40			50533 •	50543	
			60			50534 •	50544	
			80			-	50545	
		120	-	50546				

• Non-stock product, contact Customer Service for lead times and minimum order quantities.



50519

50543

FOR ALUMINUM

Tiger Aluminum flap discs offer an innovative paired flap design that delivers high performance grinding on aluminum. The top flaps have a calcium stearate coating that eliminates loading and allows the disc to maintain a high cut-rate, while the alternating flaps aggressively remove material with self-sharpening zirconia aluminum grains.

CONICAL

P HIGH PERFORMANCE / TIGER ALUMINUM

Non-Loading / Contaminant-free / Zirconia Alumina / Phenolic Back / **Contaminant-free***

ALUMINUM				TYPE 29	TYPE 29
Diameter	Grit	Max. RPM	Std. Pack	7/8" Arbor	5/8"-11 Hub
4-1/2"	36	13,000	10	51250	51254
	60			51251	51255

FLAT

P HIGH PERFORMANCE / TIGER ALUMINUM

Non-Loading / Contaminant-free / Zirconia Alumina / Phenolic Back / **Contaminant-free***

ALUMINUM				TYPE 27	TYPE 27
Diameter	Grit	Max. RPM	Std. Pack	7/8" Arbor	5/8"-11 Hub
4-1/2"	36	13,000	10	51252	51256
	60			51253	51257



51250



51257

NYLON BRUSHES

PACKAGED ITEMS

MAINTENANCE

Key:

P PERFORMANCE LINE Industrial Grade **V** VALUE LINE Professional Grade

• Non-stock product, contact Customer Service for lead times and minimum order quantities.

♦ Patent # 6,945,863

*Contaminant-free (Contains less than 0.1% Fe, S, Cl)

ANGLED DISCS

The 90° angled flap design is ideal for grinding fillet welds, T-joints and other hard-to-reach places. The flaps wrap around the edge of the backing plate, optimizing flap-to-metal contact and providing exceptional feel and control while grinding.



Angled flaps are ideal for fillet welds and hard-to-reach places



51313

P **MAX PERFORMANCE / TIGER® CERAMIC ANGLED**
 Top Coated for Cool Grinding on Fillet Welds / Ceramic Alumina / Phenolic Back / Contaminant-free*

		STEEL / METAL		STAINLESS		HARD-TO-GRIND		ALUMINUM		7/8" Arbor		5/8"-11 Hub	
Diameter	Grit									Item #	Item #		
4-1/2"	40									51312	51315		
	60									51313	51316		
	80									51314	51317		
5"	40									51318	51321		
	60									51319	51322		
	80									51320	51323		



51303

P **HIGH PERFORMANCE / TIGER ANGLED**
 Fast Grinding & Long Life on Fillet Welds / Zirconia Alumina / Phenolic Back / Contaminant-free*

		STEEL / METAL		STAINLESS						7/8" Arbor		5/8"-11 Hub	
Diameter	Grit									Item #	Item #		
4-1/2"	40									51300	51303		
	60									51301	51304		
	80									51302	51305		
5"	40									51306	51309		
	60									51307	51310		
	80									51308	51311		

TRIMMABLE DISCS

A trimmable backing plate allows the operator to increase flap overhang. This feature provides the versatility to adjust for hard-to-reach areas such as fillet welds and irregular shapes.



50121

P **MAX PERFORMANCE / TIGER CERAMIC TRIM (SABER TOOTH)**
 Top Coated for Cool Grinding / Ceramic Alumina / Trimmable Composite Back for Versatility / Contaminant-free*

		STEEL / METAL		STAINLESS		HARD-TO-GRIND		ALUMINUM		TYPE 29 7/8" Arbor		TYPE 29 5/8"-11 Hub	
Diameter	Grit									Item #	Item #		
4-1/2"	40									50117	50121♦		
	60									50118	50122♦		
	80									50119	50123♦		



50003

P **PERFORMANCE / TIGER TRIM**
 Long Grinding Life / Zirconia Alumina / Trimmable Composite Back for Versatility / Contaminant-free*

		STEEL / METAL		STAINLESS						TYPE 29 7/8" Arbor		TYPE 29 5/8"-11 Hub	
Diameter	Grit									Item #	Item #		
4-1/2"	40									50002	50006♦		
	60									50003	50007♦		
	80									50004	50008♦		
	120									50005	50009♦		
	5"	40									50010	50014	
	60									50011	50015		
	80									50012	50016		

Key:

P PERFORMANCE LINE Industrial Grade **V** VALUE LINE Professional Grade

♦ Non-stock product, contact Customer Service for lead times and minimum order quantities.
 ♦ Patent # 6,945,863 *Contaminant-free (Contains less than 0.1% Fe, S, Cl)



MINI DISCS

The expanded mini flap disc line now offers a threaded button R mount in addition to the current S mount for greater versatility to fit the most popular styles of hub pads. These discs are designed for use on die grinders to provide smooth grinding and enhanced conformability in tight areas.

Weiler BobCat Mini Flap Discs are designed and compatible for use on both industry standard hub pads.



S Mount



R Mount



Edge chamfering a fabricated stainless component.

PERFORMANCE / TIGER® BOBCAT™

Grinding Hard-to-Reach Places / Zirconia Alumina / Composite Back / **Contaminant-free***

STEEL / METAL		STAINLESS		S MOUNT* TYPE 29		S MOUNT* TYPE 27		R MOUNT+ TYPE 29		R MOUNT+ TYPE 27	
Diameter	Grit	Max. RPM	Std. Pack	Item #	Item #	Item #	Item #	Item #	Item #	Item #	Item #
2"	36	30,000	10	50922	50932	50946	50956	50923	50933	50947	50957
	40			50924	50934	50948	50958				
	60			50925	50935	50949	50959				
	80			50926	50936	50950	50960				
	120										
3"	36	20,000	10	50902	50912	50951	50961	50903	50913	50952	50962
	40			50904	50914	50953	50963				
	60			50905	50915	50954	50964				
	80			50906	50916	50955	50965				
	120										

* Back-up pad not required if used with S mount mandrel. 3" discs are compatible with Norton Speed-Lok® TS back-up pads.

+ Back-up pad required. Also compatible with 3M Roloc™ back-up pads.



COATED ABRASIVES

NON-WOVEN ABRASIVES

POWER BRUSHES

NYLON BRUSHES

PACKAGED ITEMS

MAINTENANCE

ACCESSORIES

BOBCAT DRIVE MANDRELS & METAL HUB PADS

For quick-change on tools with 1/4" collets.

Description	Std. Pack	Item #
2" & 3" S mount mandrel	1	07766
3" S mount hub pad + mandrel	1	60509
3" R mount hub pad + mandrel	1	51552



ADAPTING NUTS & SPANNER WRENCH

For use with standard, HD and specialty flap discs.

Description	Thread Size	For Use With	Std. Pack	Item #
Adapting Nuts	3/8" - 24	4" flap disc with 5/8" arbor hole (can be used with an adjustable or combination wrench)	1 Pair	56484
Adapting Nuts	5/8" - 11	4-1/2", 5" & 7" flap discs with 7/8" arbor hole	1 Pair	56494
Spanner Wrench	-	Item No. 56494 only	1	56495

When mounting, adapters must be nested, see illustration at left.



RESIN FIBER DISCS



Smoothing the edges of roller coaster track with a resin fiber disc.

NEW! Faced with the challenge of working on everything from pressure vessels to roller coasters, professionals need a solution they can count on. That's why we've expanded our line up to deliver the options needed to optimize grinding time on a wide variety of applications. With premium grain mixes that aggressively remove metal and a superior design that locks the grain in, Weiler Tiger and Wolverine resin fiber discs are designed to deliver serious grinding solutions.

- Advanced grain formulas designed to maximize cut rate on metals.
- Superior design minimizes loading, glazing and grain stripping.
- Heavy-duty vulcanized fiber backing holds up to the toughest jobs.
- Quick change hub option reduces down time and eliminates interference from adapter rings.
- Spiral molded backing pad design runs cool by increasing airflow and fits on all right angle grinders.

SELECTING THE RIGHT DISC

CASE STUDY: Learn how Tiger Ceramic resin fiber discs last longer and reduced cost for a pressure vessel fabrication company.



P MAX PERFORMANCE



TIGER® CERAMIC TOP COAT for cool, fast grinding protects from heat discoloration and prevents loading on soft alloys

GRAIN TYPE
Ceramic alumina

CONTAMINANT FREE
CONTAIN LESS THAN 0.1% IRON, SULFUR & CHLORINE

BEST ON

STEEL / METAL **STAINLESS** **HARD-TO-GRIND**

(Hard-to-grind metals include tool steel, inconel, high nickel alloy, titanium and armored steel)

P HIGH PERFORMANCE



TIGER ALUMINUM TOP COATING grinds cool and eliminates loading resulting in higher cut rates, long life and a superior finish

GRAIN TYPE
Aluminum oxide

CONTAMINANT FREE
CONTAIN LESS THAN 0.1% IRON, SULFUR & CHLORINE

BEST ON

ALUMINUM

(Aluminum and other non-ferrous metals)

P HIGH PERFORMANCE



TIGER ZIRC INFUSED WITH CERAMIC for faster grinding and longer life. Disc design optimizes grain shedding and promotes cool grinding on stainless

GRAIN TYPE
Ceramic & zirconia alumina

CONTAMINANT FREE
CONTAIN LESS THAN 0.1% IRON, SULFUR & CHLORINE

BEST ON

STEEL / METAL **STAINLESS**

(Metal includes structural steel and cast iron)

V VALUE PERFORMANCE



WOLVERINE® ZIRC FAST CUT RATE and consistent performance over the life of the disc, resulting in a great value

GRAIN TYPE
Zirconia alumina

CONTAMINANT FREE
CONTAIN LESS THAN 0.1% IRON, SULFUR & CHLORINE

BEST ON

STEEL / METAL **STAINLESS**

(Metal includes structural steel and cast iron)

V VALUE PERFORMANCE



WOLVERINE AO PREMIUM GRAINS provide an even, sharp, clean cut rate and consistent performance at a great value.

GRAIN TYPE
White aluminum oxide

BEST ON

STEEL / METAL

TIGER® CERAMIC RESIN FIBER DISCS Ceramic Alumina / Superior Life & Cut Rate on Metal

Self-sharpening Ceramic Alumina grain delivers a superior combination of life and cut rate.

Top coat grinds cool and eliminates loading.



STEEL / METAL **STAINLESS** **ALUMINUM** **HARD-TO-GRIND**

Diameter	Grit Size	Standard Pack	7/8" Arbor	5/8"-11 Hub
			Item Number	Item Number
4-1/2"	24	25	69850	69880
	36		69851	69881
	50		69852	69882
	60		69853	69883
	80		69854	69884
5"	24	25	69857	69887
	36		69858	69888
	50		69859	69889
	60		69860	69890
	80		69861	69891
7"	24	25	69864	69894
	36		69865	69895
	50		69866	69896
	60		69867	69897
	80		69868	69898
9"	24	25	69871	69901
	36		69872	69902
	50		69873	69903
	60		69874	69904
	80		69875	69905

Do not exceed maximum RPM of back-up pad.



69867



69883



69857

BONDED ABRASIVES

COATED ABRASIVES

NON-WOVEN ABRASIVES

POWER BRUSHES

ADVANCED CERAMIC GRAIN

delivers greater stock removal with a finer scratch pattern

LESS PRESSURE

for consistent material removal, reducing operator fatigue

TOP COAT

grinds cool and eliminates loading, glazing & dulling

WIDE RANGE

of grit options professionals need to get a desired finish



TIGER ALUMINUM RESIN FIBER DISCS Aluminum Oxide / Non-Loading on Non-Ferrous Metals

A top coating grinds cool and eliminates loading, which results in higher cut rates, long life and a superior finish.



ALUMINUM

Diameter	Grit Size	Standard Pack	7/8" Arbor	5/8"-11 Hub
			Item Number	Item Number
4-1/2"	24	25	60400	60600
	36		60401	60601
	50		60402	60602
	60		60403	60603
	80		60404	60604
	120		60406	60606
5"	24	25	60410	60610
	36		60411	60611
	50		60412	60612
	60		60413	60613
	80		60414	60614
	120		60416	60616
7"	24	25	60420	60620
	36		60421	60621
	50		60422	60622
	60		60423	60623
	80		60424	60624
	120		60426	60626

Do not exceed maximum RPM of back-up pad.



60420



60603

NYLOX BRUSHES

PACKAGED ITEMS

MAINTENANCE

TIGER® ZIRC RESIN FIBER DISCS Zirconia Alumina / Ceramic Infused for Faster, Longer Grinding

A unique blend of self-sharpening Zirconia Alumina and Ceramic Alumina grains deliver a fast, consistent cut rate. A superior design extends disc life by minimizing grain shedding and promotes cool grinding.



P

STEEL / METAL **STAINLESS**



Diameter	Grit Size	Standard Pack	7/8" Arbor	5/8"-11 Hub
			Item Number	Item Number
4-1/2"	24	25	59731	59931
	36		59732	59932
	50		59733	59933
	60		59734	59934
	80		59735	59935
	100		59736	59936
5"	120		59737	59937
	24	25	59701	59901
	36		59702	59902
	50		59703	59903
	60		59704	59904
	80		59705	59905
100	59706		59906	
7"	120		59707	59907
	24	25	59711	59911
	36		59712	59912
	50		59713	59913
	60		59714	59914
	80		59715	59915
100	59716		59916	
	120		59717	59917

Do not exceed maximum RPM of back-up pad.

WOLVERINE® ZIRC RESIN FIBER DISCS Zirconia Alumina / Fast Grinding on Metal

Self-sharpening Zirconia Alumina grain delivers a fast cut rate and consistent performance over the life of the disc, resulting in a great value.



V

STEEL / METAL **STAINLESS**



Diameter	Grit Size	Standard Pack	7/8" Arbor	5/8"-11 Hub
			Item Number	Item Number
4-1/2"	24	25	62002	62052
	36		62003	62053
	50		62004	62054
	60		62005	62055
	80		62006	62056
	100		62007	62057
	120		62008	62058
	5"		24	25
36		62013	62063	
50		62014	62064	
60		62015	62065	
80		62016	62066	
100		62017	62067	
120		62018	62068	
7"		24	25	
	36	62023		62073
	50	62024		62074
	60	62025		62075
	80	62026		62076
	100	62027		62077
	120	62028		62078
	9"	24		25
36		62033	62083	
50		62034	62084	
60		62035	62085	
80		62036	62086	
100		62037	62087	
120		62038	62088	

Do not exceed maximum RPM of back-up pad.

WOLVERINE® AO RESIN FIBER DISCS White Aluminum Oxide / Fast Grinding on Metal
 Premium Aluminum Oxide grains provide an even, sharp, clean cut rate and consistent performance at a great value.



V

STEEL / METAL

Diameter	Grit Size	Standard Pack	5/8" Arbor	
			Item Number	
4"	24	25	59491	
	36		59492	
	50		59493	
	60		59494	
	80		59495	
	100		59496	
	120		59497	
Diameter	Grit Size	Standard Pack	7/8" Arbor	5/8"-11 Hub
			Item Number	Item Number
4-1/2"	24	25	59571	59971
	36		59573	59973
	50		59575	59975
	60		59576	59976
	80		59577	59977
	100		59578	59978
	120		59579	59979
5"	16	25	59500	-
	24		59501	61501
	36		59503	61503
	50		59505	61505
	60		59506	61506
	80		59507	61507
	100		59508	61508
	120		59509	61509
7"	16	25	59520	-
	24		59521	61521
	36		59523	61523
	50		59525	61525
	60		59526	61526
	80		59527	61527
	100		59528	61528
	120		59529	61529
9"	24	25	59541	61541
	36		59543	61543
	50		59545	61545
	60		59546	61546
	80		59547	61547
	100		59548	61548
	120		59549	61549

Do not exceed maximum RPM of back-up pad.



59492



59973



61501



59611



59604



59603

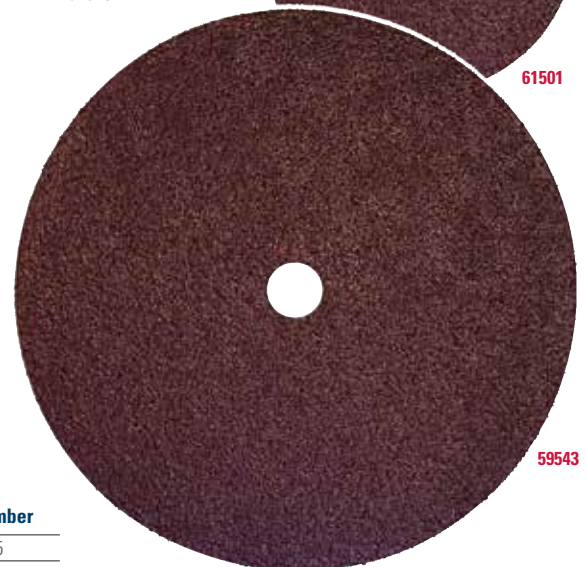

59543

ACCESSORIES FOR RESIN FIBER DISCS

Description	Thread Size	Max. RPM	Standard Pack	Item Number
4" Back-up Pad	5/8"-11*	12,000	1	59605
4-1/2" Back-up Pad	5/8"-11*	11,000	1	59611
5" Back-up Pad	5/8"-11*	10,000	1	59600
7" Back-up Pad	5/8"-11	8,500	1	59601
9" Back-up Pad	5/8"-11	6,500	1	59602
Spanner Wrench	-	-	1	59603
Disc Nut	5/8"-11	-	1	59604

* Other thread sizes available on special orders.

WHY WEILER
BONDED ABRASIVES

COATED ABRASIVES

NON-WOVEN ABRASIVES

POWER BRUSHES

NYLOX BRUSHES

PACKAGED ITEMS

MAINTENANCE

BLENDING DISCS



Blending surface imperfections prior to painting.

Weiler's cloth backed coated abrasive discs are for use on right angle air tools. Available with either a metal hub or a plastic button fastening system, the flexible back-up pads give the discs a great deal of conformability. Weiler's blending discs are suitable for a wide range of light fabrication, repair and maintenance applications.



60150

P TIGER® CERAMIC ALUMINA BLENDING DISCS

For aluminum, stainless and other hard-to-grind metal applications.

Diameter	Grit Size	Standard Pack	Item Number	
			Type S Hub Style	Type R Hub Style
2"	36	50	60150	60170
	60		60151	60171
	80		60152	60172
3"	36	25	60155	60175
	60		60156	60176
	80		60157	60177



60395

P TIGER BLENDING DISCS - Type S Hub Style

Compatible with Norton Speed-Lok® TS back-up pads.

Diameter	Grit Size	Standard Pack	Item Number	
			Zirconia Alumina	Aluminum Oxide
2"	36	100	60378	60040
	60		60381	60043
	80		60382	60044
	120		60384	60046 •
	3"		36	60391
3"	60	50	60394	60056
	80		60395	60057
	120		60397	60059

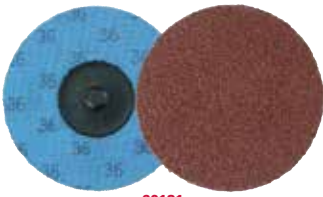

60131

P TIGER BLENDING DISCS - Type R Hub Style - Compatible with 3M Roloc™ back-up pads.

Diameter	Grit Size	Standard Pack	Item Number - Aluminum Oxide
2"	36	100	60118
	60		60121
	80		60122
	120		60124
3"	36	50	60131
	60		60134
	80		60135
	120		60137



59875

P TIGER ALUMINUM BLENDING DISCS - Aluminum Oxide

Diameter	Grit Size	Standard Pack	Item Number	
			Type R Hub Style*	Type S Hub Style +
2"	36	50	59806	59869
	60		59807	59870
	80		59808	59871
	120		59809	—
	3"		36	25
60	59812	59875		
80	59813	59876		
120	59814	59877 •		



60508



51552

P BACK-UP PADS - 1/4" Stem

Diameter	Max. RPM	Std. Pack	Item No.	
			Type R Hub Style*	Type S Hub Style+
2"	25,000	1	51551	60508
3"	20,000	1	51552	60509

Do not exceed maximum RPM of back-up pad.

* Compatible with 3M Roloc™ back-up pads. (Roloc™ is a trademark of 3M.) • Non-stock product, contact Customer Service for lead times and minimum order quantities.

+ Compatible with Norton Speed-Lok® TS back-up pads. (Speed-Lok® TS is a registered trademark of Norton Co.)

TRIM-KUT® DISCS

Trim-Kuts are abrasive discs designed for light grinding and blending applications on a variety of materials. The abrasive grains are fused directly onto a wearable polymer backing, resulting in a disc that requires no back-up pad. The polymer backing trims during use to expose new grains to the work surface. 3" discs are designed for use on right angle air die grinders, and 4-1/2" discs are for use on right angle grinders.

APPLICATIONS

- Edge blending
- Preparation for painting and surface finishing
- Light weld and stock removal
- Deburring



Deburring and chamfering a section of pipe after cutting.

P

TRIM-KUT® DISCS - Aluminum Oxide

Diameter	Arbor Hole	Grit Size	Max. RPM	Standard Pack	Item Number
3"	5/16" - 18	36	21,000	25	59300
		60			59305
		120			59315

Do not use TRIM-KUT discs in temperatures lower than 48° fahrenheit. Store at 50% relative humidity.



59300

COATED ABRASIVES

P

TRIM-KUT DISC - Aluminum Oxide

Diameter	Arbor Hole	Grit Size	Max. RPM	Standard Pack	Item Number
4-1/2"	7/8"	36	13,000	25	59403

Do not use TRIM-KUT discs in temperatures lower than 48° fahrenheit. Store at 50% relative humidity.



59403

P

TRIM-KUT ADAPTERS

Description	For Use With	Standard Pack	Item Number
1/4" Mandrel	3" TRIM-KUT Discs	25	59327
3/8"-24 UNF Adapter	3" TRIM-KUT Discs	25	59326 •
Adapting Nuts	4-1/2" TRIM-KUT Discs	1	56485
Spanner Wrench	Item No. 56485 only	1	56496 •

• Non-stock product, contact Customer Service for lead times and minimum order quantities.



59327

59326



56485

56496

POWER BRUSHES

NYLON BRUSHES

PACKAGED ITEMS

MAINTENANCE



NOTE

If you are using a blending disc or TRIM-KUT Disc, ask our Application Engineering Department if Weiler's BobCat Abrasive Flap Discs can enhance your productivity. BobCats dramatically outperform blending and TRIM-KUT Discs by reducing changeovers and providing consistently high cut rates and extended life. See page 43 for more information.

Key:

P

Performance line
Industrial Grade

V

Value line
Professional Grade

COATED ABRASIVE FLAP WHEELS



Weiler's abrasive flap wheels are designed with a solid hub construction that enables wheels to be rated at higher RPMs and provide more aggressive cutting action and increased productivity. They provide perfect balance leading to smooth, chatter-free finishing.

Applications

- Internal diameter cleaning
- Finishing metal surfaces
- Deburring machined parts
- Cleaning and reconditioning pipe threads
- Polishing, blending & finishing
- Prepping surface for painting or plating
- Edge blending



Removing burrs from the inside diameter of a cut tube.



52010



52027



52621



53286

P TIGER® MOUNTED FLAP WHEELS - 1/4" Stem - Aluminum Oxide

A premium line designed to provide long life. Ideal for medium to high production environments.



Diameter	Width	Grit Size	Max. RPM	Standard Pack	Item Number
1"	1"	60	30,000	10	52003
		80			52004
		120			52005
1-1/2"	1"	60	25,000	10	52009
		80			52010
		120			52011
2"	1/2"	60	25,000	10	52366
	80	52367			
2"	1"	60	25,000	10	52015
		80			52016
		120			52017
2-1/2"	1"	60	23,000	10	52486
		80			52487
3"	1/2"	60	23,000	10	52024
		80			52025
3"	1"	60	23,000	10	52027
		80			52028
		120			52029

P TIGER MOUNTED FLAP WHEELS - 1/4"-20 Threaded Stem - Aluminum Oxide

A premium line designed to provide long life. Ideal for medium to high production environments.



Diameter	Width	Grit Size	Max. RPM	Standard Pack	Item Number
1"	1"	60	30,000	10	52601
		80			52603
		120			52605
2"	1"	60	25,000	10	52611
		80			52613
3"	1"	60	20,000	10	52621
		80			52623

P TIGER UNMOUNTED FLAP WHEELS - Aluminum Oxide



Diameter	Width	Arbor Hole	Grit Size	Max. RPM	Standard Pack	Item Number
6"	1"	1"	60	6,000	5	53286
			80			53287
6"	2"	1"	60	5,700	3	53326 •
			80			53327

• Non-stock product, contact Customer Service for lead times and minimum order quantities.

NOTE

- Drive arbor is used individually and must be ordered individually.
- Drive arbor is to be used with Weiler flap wheels only.
- Stems must be fully chucked before using and should not be run above the maximum RPM listed.

Key:

P Performance line
Industrial Grade

V Value line
Professional Grade



GREAT VALUE AT THE RIGHT PRICE

Wolverine Flap Wheels offer a high cut rate at a cost-effective price. The smart option for use in medium production environments.

APPLICATIONS

- Internal diameter cleaning
- Finishing metal surfaces
- Deburring machined parts
- Cleaning and reconditioning pipe threads
- Polishing, blending & finishing
- Prepping surface for painting or plating
- Edge blending



WOLVERINE® 1/4" STEM MOUNTED FLAP WHEELS

Provide fast cutting action at a value price. Ideal for low to medium production environments.

Diameter	Width	Grit Size	Max. RPM	Standard Pack	Item Number	
					Aluminum Oxide	
5/8"	5/8"	40	30,000	10	30711	
		60			30712	
		80			30713	
3/4"	3/4"	40	30,000	10	30715	
		60			30716	
		80			30717	
1"	1"	40	30,000	10	30719	
		60			30720	
		80			30721	
		120			30722	
1-1/2"	1"	40	25,000	10	30771	
		60			30772	
2"	1"	40	25,000	10	30732	
		60			30723	
		80			30724	
		120			30725	
2-1/2"	1"	40	23,000	10	30778	
3"	1"	40	23,000	10	30729	
		60			30726	
		80			30727	
		120			30728	



30712



30720



30724



WOLVERINE 1/4"-20 THREADED STEM MOUNTED FLAP WHEELS

Provide fast cutting action at a value price. Ideal for low to medium production environments.

Diameter	Width	Grit Size	Max. RPM	Standard Pack	Item Number	
					Aluminum Oxide	
1"	1"	60	30,000	10	30745	
		80			30746	
2"	1"	60	25,000	10	30737	
		80			30738	
3"	1"	60	20,000	10	30735	
		80			30736	



30735

DRIVE ARBOR - For 1/4"-20 Mounted Flap Wheels

Thread Size	Adapted Size	Standard Pack	Item Number
1/4"-20	1/4"	5	07756



07756

METAL ADAPTERS - For Unmounted Flap Wheels. Used in pairs and priced per pair.

Wheel Arbor Hole Size	Adapted Arbor Hole Size	Standard Pack	Item Number
1"	1/2"	1	03833
	5/8"		03834
	3/4"		03835 •



03834

• Non-stock product, contact Customer Service for lead times and minimum order quantities.

COATED ABRASIVE SHOP ROLLS



Polishing the O.D. of a part turning in a lathe.

Weiler's Shop Rolls are resin over resin bonded - providing a stronger, heat and moisture resistant bond that better utilizes the abrasive grains. The cotton cloth provides a tougher, durable backing for longer life. J-flex cloth provides a higher degree of flexibility to conform to contoured parts.

APPLICATIONS

- Off-hand polishing of metal surfaces
- Off-hand deburring
- General purpose machine shop use
- Cleaning stock that is being turned in a lathe

P TIGER® SHOP ROLLS - Aluminum Oxide - 50 Yards. One roll per box.

Roll Width	Grit Size	Standard Pack	Item Number
1"	60	1	65205
	80		65206
	100		65207 •
	120		65208
	150		65209 •
	180		65210 •
	240		65212 •
1-1/2"	320	1	65213
	60		65218
	80		65219
	100		65220
	120		65221
	150		65222
	180		65223
2"	240	1	65225
	320		65226
	60		65231
	80		65232
	100		65233
	120		65234
	150		65235
180	65236		
240	65238		
320	65239		

• Non-stock product, contact Customer Service for lead times and minimum order quantities.



65204

NOTE

Use light machine oil with shop rolls as a lubricant for finer finishes and quicker cut.

Key:

P Performance line
Industrial Grade

V Value line
Professional Grade

NON-WOVEN ABRASIVES

FINEST AT THE FINISH

Non-woven abrasive products can be used in a broad range of surface-conditioning applications from cleaning and finishing to deburring and light blending. Unlike bonded and coated abrasives, they cannot be used for applications requiring heavy stock removal such as grinding and weld blending.

Non-Woven Abrasives Overview	54
Unitized Wheels	54
Interleaf Flap Wheels	55
Hand Pads	55
Surface Conditioning Discs.....	56

SELECTING THE RIGHT PRODUCT

The various grades of non-woven products produce scratch patterns that can be compared to those produced by coated abrasive products. However, their pliable nature results in a softer, less pronounced scratch-line pattern. The strength of these products is producing decorative finishes ranging from satin to near-mirror polish.

Denser non-woven products are suitable for applications requiring light stock removal such as removing large, well-attached burrs and blending minor tool marks and imperfections.

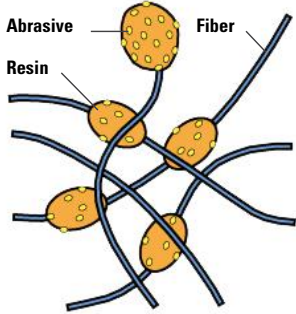

All non-woven products are fabricated from base materials that are composed of a random "web" of nylon fibers that have been bonded together with synthetic resins and impregnated with abrasive grains. Although these materials vary in fiber density, their three dimensional nature results in specialty abrasive products that are pliable, conformable to the work surface, and limited in their ability to remove base stock.

Non-woven products resist loading and perform consistently as new, fresh abrasive grains are exposed as the nylon fibers wear away from the product during use. Non-woven abrasives can be used either wet or dry on a range of materials including ferrous and non-ferrous metals, ceramics, plastics, composites, and wood. Non-woven products are designed for use where stock removal is not required. Non-wovens begin where coated abrasives leave off.

Grade	Grit Range
Ultra Fine	600
Very Fine	240-360
Fine	180-220
Medium	100-150
Coarse	50-80

UNITIZED WHEELS



P **UNITIZED WHEELS** - Designed for use on die grinders and are ideal for a variety of cleaning, finishing, deburring and edge blending applications.



Diameter	Face Width	Arbor Hole	Grain	Grade	Max. RPM	Standard Pack	Item Number
Series 2 - Cleaning & Finishing - Hardness: Soft							
3"	1/4"	1/4"	Aluminum Oxide	Fine	12,000	10	55512
			Silicon Carbide	Fine			55513 •
Series 6 - Deburring - Hardness: Medium/Hard							
3"	1/4"	1/4"	Aluminum Oxide	Fine	18,000	10	54492
Series 8 - HD Deburring & Polishing - Hardness: Hard (Heavy-Duty)							
3"	1/8"	1/4"	Aluminum Oxide	Coarse	18,000	10	55546
	1/4"			Medium			55541
	1/2"			Medium			55542

• Non-stock product, contact Customer Service for lead times and minimum order quantities.

MANDRELS



Stem Diameter	For Wheel Diameter	For Wheel Thickness	Standard Pack	Item Number
1/4"	2" - 3"	1/2"	1	07761
	1"	1"	1	07764 •
	2" - 3"	1/8" - 1/4"	10	56489

• Non-stock product, contact Customer Service for lead times and minimum order quantities.

INTERLEAF FLAP WHEELS

Interleaf Flap Wheels provide a combination of non-woven and coated abrasive material to produce a very conformable product compared to a standard coated abrasive flap wheel. They are designed to be a finishing and surface blending tool as compared to a material-removing coated abrasive flap wheel. They are ideal for producing satin or decorative finishes on irregular or contoured surfaces.

APPLICATIONS

- General decorative finishing
- Applying satin finishes
- Producing antique finishes
- Final sandings
- Soft metal finishing
- Removing oxides from precious metals
- Fine burr removal

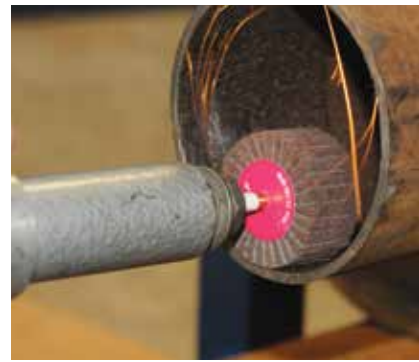

Deburring the I.D. of a steel pipe with an interleaf flap wheel.

P STEM-MOUNTED INTERLEAF FLAP WHEELS - Aluminum Oxide

Diameter	Face Width	Grit Size	Stem Size	Max. RPM	Standard Pack	Item Number
2"	1"	120	1/4"	13,700	10	54500
		180				54501
		320				54502
3"	1"	120	1/4"	8,600	5	54506
		180				54507
		320				54508
3"	2"	120	1/4"	8,600	10	54509
		180				54510
		320				54511



54500



54510

COATED ABRASIVES

NON-WOVEN ABRASIVES

HAND PADS

Industrial Grade:

- Producing satin finishes on aluminum and stainless steel
- Light deburring
- Surface preparation
- Blending light scratches

Commercial Grade:

- Cleaning and removing stains from stainless steel
- Removing rust, corrosion and oxidation



Polishing a rail axle journal with a non-woven hand pad.

POWER BRUSHES

NYLOX BRUSHES

P HAND PADS - For cleaning and conditioning surfaces by hand. Unlike steel wool, hand pads are non-metallic, and do not produce "after-rust" on work surfaces. Hand pads can be used in wet applications.

Size	Grain	Grade	Description	Standard Pack	Item Number
Industrial Grade					
6" x 9"	Silicon Carbide	Ultra Fine	Finishing (Grey)	60	51434
6" x 9"	Aluminum Oxide	Medium	Economy General Purpose (Maroon)	60	51460
6" x 9"	Aluminum Oxide	Med/ Coarse	General Purpose (Maroon)	60	51444
6" x 9"	Aluminum Oxide	Heavy-Duty	Heavy-Duty (Tan)	40	51454
Commercial Grade					
6" x 9"	Aluminum Oxide	Fine	Economy (Green)	400	51456
6" x 9"	Aluminum Oxide	Medium	Standard-Duty (Green)	60	51457
6" x 9"	Aluminum Oxide	Heavy-Duty	Heavy-Duty (Green) 20% thicker than Standard Duty	60	51458

51460

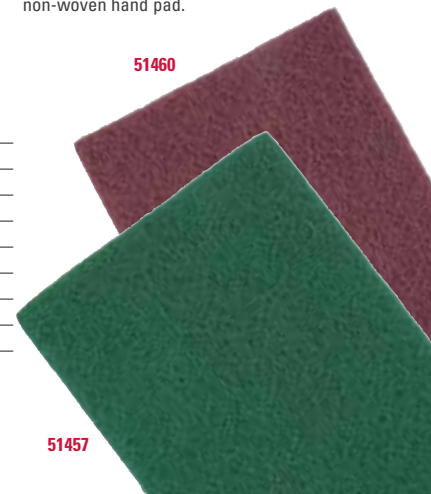

51457

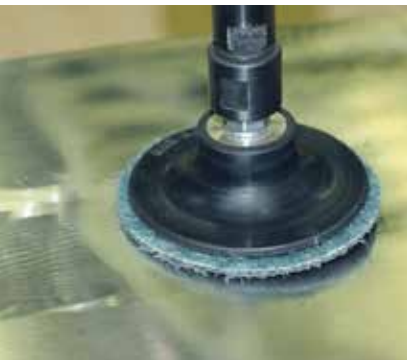

SURFACE CONDITIONING DISCS

Surface Conditioning Discs have an open construction, scrim reinforcement and a superior resin system. These features minimize loading, heat build-up, fraying of disc edges, grain shedding and extend disc life, providing superior performance.

APPLICATIONS

- Light deburring
- Surface preparation
- Blending light scratches
- Removing rust, corrosion and oxidation
- Cleaning and removing stains from stainless steel
- Producing satin finishes on aluminum and stainless steel

Finishing the surface for a stainless steel part for the food service industry.



P TYPE R HUB STYLE DISCS - General Purpose

Compatible with 3M Roloc™ back-up pads.



Diameter	Grade	Standard Pack	Item Number
2"	Very Fine (Blue)	50	51530
	Medium (Maroon)		51531
	Coarse (Brown)		51532
3"	Very Fine (Blue)	25	51533
	Medium (Maroon)		51534
	Coarse (Brown)		51535

TYPE R HUB STYLE BACK-UP PADS - 1/4" Stem

Diameter	Max. RPM	Standard Pack	Item Number
2"	30,000	1	51551
3"	20,000	1	51552

Do not exceed maximum RPM of back-up pad.



P HOOK & LOOP STYLE DISCS



Diameter	Grade	Standard Pack	Item Number
3"	Very Fine (Blue)	25	51506 •
	Medium (Maroon)		51507 •
	Coarse (Brown)		51508 •
4-1/2"	Very Fine (Blue)	10	51512
	Medium (Maroon)		51513
	Coarse (Brown)		51514
5"	Very Fine (Blue)	10	51515
	Medium (Maroon)		51516
	Coarse (Brown)		51517
7"	Very Fine (Blue)	10	51521
	Medium (Maroon)		51522
	Coarse (Brown)		51523

• Non-stock product, contact Customer Service for lead times and minimum order quantities.

HOOK & LOOP STYLE BACK-UP PADS

Diameter	Arbor Hole or Stem Size	Max. RPM	Standard Pack	Item Number
3"	1/4" Stem	18,000	1	51562
4-1/2"	5/8" -11 Arbor	13,000	1	51569
5"	5/8" -11 Arbor	10,000	1	51575
7"	5/8" -11 Arbor	6,000	1	51578

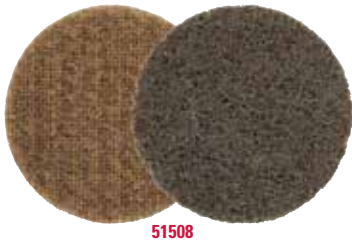



POWER BRUSHES

CHOOSE QUALITY

Superior construction, the highest quality materials, state of the art manufacturing and exacting quality standards deliver the most consistent brush performance. Each Weiler brush is designed to provide the best performance at the lowest cost-of-use.

Superior performance is now even easier to see. Our most popular stainless steel brushes are now color-coded black for easy identification, even during operation. See the items bold in black throughout this section.

Technical Information.....	60-66
Knot Wire Wheels.....	67-73
Weld Cleaning Brushes.....	72-73
Crimped Wire Wheels.....	74-81
Nylon & Tampico Wheels	82
Cup Brushes	83-85
Stem-Mounted End Brushes.....	86-89
Crosshole Deburring Brushes	90
Power & Hand Tube Brushes.....	91-95
Crossflex Honing Brushes.....	96-99
Miniature Brushes.....	100-101
Non-Sparking Brushes	102-103
Wide Face Brushes.....	104-105

SOLUTIONS SHOWCASE

TUBE END DEBURRING

Problem: Structural tubing is fabricated into an abundance of different forms. In order to facilitate safer handling and proper fit, the ends of the tubing must frequently be deburred.

Solution: Wide face crimped wire wheel brushes are an extremely effective solution for tube end deburring. Brushes can deburr the OD and ID of tubing at an extremely high rate and produce a media-cost-per-part of considerably less than \$0.01 per part.



GEAR DEBURRING

Problem: Power transmission components like gears cannot function properly when burrs prevent correct engagement. Further, burrs that become detached from gears can become lodged in critical transmission components causing premature wear and potential failure.

Solution: Knot wire wheel brushes with surface speed in excess of 6,000 SFPM are an excellent solution for deburring gears prior to heat treatment. The high energy filament tips are able to separate burrs from base material and produce a uniform edge break, which protects the edge of the gear.



Photos courtesy of On-Line Services.

REMOVAL OF MILL SCALE

Problem: Mill processing of steel often involves heat treating and oil quenching operations that produce an adherent scale, which must be removed prior to joining or finishing operations.

Solution: Wire brushes are capable of quickly cleaning material to white metal and producing varying degrees of surface roughening to promote adhesion. Brushing operations are often preferred over blasting and chemical processes that generate an expensive waste stream and can be costly to operate and maintain.



INTER-PASS PIPELINE WELD CLEANING



Problem: To prevent voids and inclusions when welding multi-pass joints, the surface of each bead must be completely cleaned of slag and other residuals. Performing inter-pass weld cleaning as quickly and as thoroughly as possible is critical to avoiding costly repair work and delays.

Solution: Weiler's Roughneck® and Dually® stringer bead wheels have been engineered to maximize efficiency and minimize costs and are the preferred choice of welders' helpers on the pipeline. From hot pass to cap pass, these premium weld cleaning brushes excel at quickly and thoroughly removing slag, spatter, and oxidation without damaging the filler material.

CLEANING THREADED CONNECTIONS



Problem: The box ends of drill string and other oilfield tubular goods are examples of connections that must be periodically cleaned without altering the geometry of the threads. Abrasive products all remove base material to some extent and are capable of damaging threads, resulting in unreliable connections and the risk of potential failures.

Solution: The conformability and impact action of small diameter crimped wire wheels make them ideal tools for cleaning threads without fear of damage. When used on a high-speed die grinder, these radial wheel brushes quickly remove residual dope as well as rust, corrosion and scale from male or female thread ends.

REMOVAL OF EXCESS MOLDED RUBBER



Problem: Mechanical rubber components such as motor mounts are produced through a process that commonly leaves flash and excess rubber on critical surfaces. In order for the component to function properly, this unwanted material must be removed.

Solution: The non-loading nature of wire brushes makes them the best available solution in the marketplace for removal of rubber from targeted surfaces. This solution can be implemented off-hand or using automated equipment.

SELECTING THE RIGHT BRUSH

SELECTION BY TOOL

	<i>Crimped Wheels</i>	<i>Knot Wheels</i>	<i>Crimped Cups</i>	<i>Knot Cups</i>	<i>Crimped Stem-Mtd. Wheels</i>	<i>Knot Stem-Mtd. Wheels</i>	<i>Crimped Stem-Mtd. End</i>	<i>Knot Stem-Mtd. End</i>	<i>Encapsulated Brushes</i>	<i>Power & Hand Tube Brushes</i>	<i>Mini Brushes</i>
Right Angle Grinder	✓	✓	✓	✓					✓		
Straight Grinder	✓	✓			✓	✓	✓	✓	✓		
Die Grinder	✓	✓			✓	✓	✓	✓	✓		
Corded/Cordless Hand Drill					✓	✓	✓	✓		✓	
High Speed Pencil Grinder											✓
Bench/Pedestal Grinder	✓	✓							✓		
Drill Press					✓	✓	✓	✓		✓	
CNC/Milling/ Automatic Machine	✓	✓	✓	✓	✓	✓	✓	✓	✓	✓	

WIRE SIZE

To maximize brush life and reduce costs, always use the finest wire that will accomplish the job without requiring excessive applied pressure or engagement with the brush face.

Wire Gauge #	Coarse		Medium to Coarse		Medium		Fine		Very Fine	
Dia. in Inches	.035	.023	.020	.014	.0118	.0104	.0095	.008	.006	.005
Dia. in Millimeters	0,89	0,58	0,51	0,36	0,30	0,26	0,24	0,20	0,15	0,13

Wire sizes in decimals of an inch are shown in all tables throughout this catalog. American Steel Wire Equivalent Gauge (Formerly Washburn & Moen)

LARGE DIAMETER WIRE

- Aggressive brushing action
- Fatigues and breaks more quickly

SMALL DIAMETER WIRE

- Resists fatigue and breakage
- Less aggressive
- Flexible brushing action

CRIMPED VS. KNOT WIRE

CRIMPED WIRE BRUSHES:



- Greater flexibility for light/medium duty applications.
- Use on parts that could be damaged by the impact of a knot brush.
- Use for a broad range of applications.

KNOT WIRE BRUSHES:



- Straight wire filaments that are twisted as a single unit like a piece of cable or wire rope.
- Provide less flexibility and more aggressive brushing action in heavy-duty applications.
- Use on parts requiring high-impact action.
- Use to remove large burrs and heavy contamination, such as multiple layers of rust, scale, paint or oxides.

KNOT TWIST CONFIGURATIONS



STANDARD

Provides some flexibility for use on irregular surfaces. Sharp wire tips make this knot aggressive right from the start.



HURRICANE®

Provides smoother operation but sacrifices much of the cleaning action.



CABLE

Provides very aggressive brushing action. Sharp wire tips make this knot aggressive right from the start.



STRINGER BEAD

High-impact action, primarily for weld cleaning. Sharp wire tips make this knot aggressive right from the start.

TRIM LENGTH & FILL DENSITY

To maximize brush life and reduce costs, always use the shortest trim, highest density brush that will adequately conform to the surface or part edges.

LONG TRIM, LOW DENSITY BRUSHES

- Flexibility that is ideal for applications such as cleaning surfaces that are somewhat irregular
- Lower fill density can result in shorter brush life and less consistent performance in production environments.

SHORT TRIM, HIGH DENSITY BRUSHES

- Less flexible and faster action requires less applied pressure
- Consistent performance and longer life



POLYFLEX® ENCAPSULATED

These brushes are suitable for extremely demanding applications that do not require a high degree of conformability. They are especially well-suited for users with the following types of requirements:

Extreme brushing pressure - Encapsulation protects wires from over-flexing and extends brush life relative to conventional knot and crimped wire brushes.

Severe cleaning operations - Encapsulation holds the wire tips rigidly in place and creates the most aggressive brushing action that can be achieved with a wire brush.

BURGUNDY (STANDARD)



General purpose elastomer; suitable for most manufacturing applications.

ORANGE (HEAVY-DUTY)



A more heavy-duty elastomer than burgundy; used for more demanding applications.

BLACK (EXTRA HEAVY-DUTY)



A heat stabilized elastomer that does not wear easily; used primarily for cleaning welds.

ARBOR HOLE VARIATIONS

FOR WEILER PERFORMANCE LINE WHEELS

If an arbor hole size other than the size listed in the product table is required, change the last digit of the Item Number as indicated in the Table.

Arbor Hole Diameter	Arbor Hole Features	Change Last Digit of Item # To:
1/2"-3/8"	Plastic Snap-Out Adapter	4
5/8"-1/2"	Plastic Snap-Out Adapter	5
5/8"-11 UNC	Threaded Nut (6", 7" & 8" Wheels Only)	6
5/8"	3", 4" & 6" Wheels Only	7
3/4"	—	8
7/8"	—	0 - 11
1"	1/4"*x 1/8"+ double keyway	0 - 12
1-1/4"	5/16"*x 5/32"+ double keyway	9
1-1/2"	3/8"*x 3/16"+ double keyway	0 - 13
1-3/4"	3/8"*x 3/16"+ double keyway	0 - 16
2"	1/2"*x 1/4"+ double keyway	0 - 14
2-1/4"	3/4"*x 3/8"+ double keyway	0 - 17
2-1/2"	1/2"*x 1/4"+ double keyway	0 - 15

* Width of keyway

+ Depth of keyway

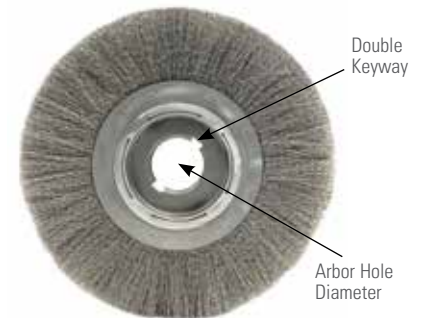

Example: Item Number 01228 has a listed, standard size arbor hole of 3/4". If an 1-1/4" arbor hole is desired, drop the 8 from 01228 and add 9. The Item Number becomes 01229. If a 2" arbor hole is desired, drop the 8 from 01228 and add 0-14. The Item Number becomes 01220-14.

PRODUCT ADVANTAGES

PRODUCT LINE STRUCTURE

P PERFORMANCE LINE (INDUSTRIAL GRADE)

Engineered and manufactured to maximize performance and minimize operating costs in the most demanding surface conditioning applications. The use of superior construction, the highest quality materials and the most stringent manufacturing processes deliver the lowest cost-of-use and most consistent performance in heavy production environments.

V VALUE LINE (PROFESSIONAL GRADE)

Weiler's value line is manufactured using similar product construction and the same exacting standards as other Weiler power brushes, but engineered to provide cost-effective use in less demanding environments. Wolverine™ brushes (Formerly Vortec Pro®) are an economical choice for the construction trades, low volume production shops and light duty industrial MRO use.

OPERATIONAL ADVANTAGES

POWER BRUSHES DO NOT REMOVE BASE MATERIAL

- The impact action of the wire tips of a rotating brush behave in the same manner as the media in a blasting operation and they have the same ability to separate surface contaminants without damaging the substrate.
- Due to its compliant nature, a power brush is the ideal tool for removing burrs and blending sharp edges without changing overall part dimensions after sawing, cutting, grinding and machining operations.

Grinding Wheel



Wire Wheel



POWER BRUSHES DO NOT LOAD

Unlike bonded, coated and non-woven abrasive products, power brushes will not load when used on softer materials or when removing paint or similar coatings from a harder surface. Because a power brush consists of a collection of individual wire filaments, there is no place for debris to accumulate and prevent the sharp wire tips from striking the work.

Resin Fiber Disc



Wheel Brush



POWER BRUSHES ARE SELF-SHARPENING

As a power brush is used, the wire tips will naturally tend to wear to a point due to contact with the working surface. It is possible to take advantage of this self-sharpening action by periodically switching the mounting position of wheel brushes to maintain their speed and effectiveness.

WEILER SUPERIOR CONSTRUCTION



WEILER'S SOLID RING CONSTRUCTION

Our crimped wire brushes are constructed using solid rings to retain the fill material and our manufacturing process results in an even, consistent distribution of wire strands around the entire brush diameter. This ensures that our crimped wire products run smoother and last longer than the competition – even in the toughest applications.



WEILER'S INDIVIDUAL KNOT HOLE CONSTRUCTION

Weiler's knot wheels are constructed with an internal steel plate that has equally spaced individual holes around the perimeter. Wire is inserted through each hole and twisted into a knot. Each hole has precisely the same wire count, thereby assuring perfect balance. This eliminates vibration, reduces operator fatigue and increases brush life.

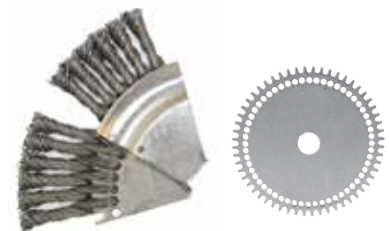

WEILER'S ROUGHNECK® WELD CLEANING BRUSH CONSTRUCTION

Each knot is twisted through its own hole and locked into an individual sprocket tooth. This prevents the knots from moving, providing a stronger striking action on the work surface, longer brush life and less operator fatigue. This results in the most aggressive weld cleaning in the market with the lowest cost-per-piece brushed.

PRODUCT CHARACTERISTICS

WHEEL BRUSH

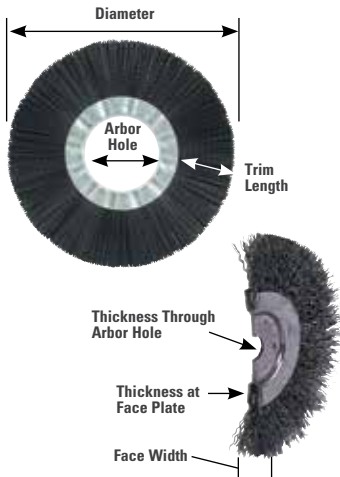

CUP BRUSH



END BRUSH



TUBE BRUSH

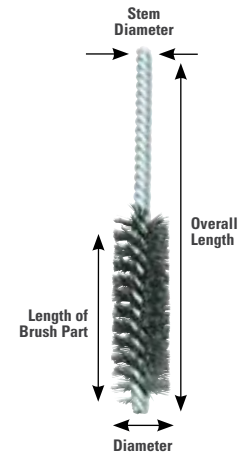

FILL MATERIALS



Steel Wire - Carbon steel wire is the most durable power brush fill material for metalworking and heavy-duty cleaning applications. **Weiler industrial grade brushes** utilize heat treated, high tensile steel wire that has been drawn to the most exacting industry standards for superior fatigue resistance and aggressive brushing action. **Vortec Pro® professional grade brushes** utilize more cost-effective grades of steel wire to deliver reliable performance in less demanding applications.



Stainless Steel Wire - Stainless steel wire is only recommended when brushing corrosion-resistant or non-ferrous metals such as stainless or aluminum or when the brush is being used in a wet environment. Stainless steel wire is not any more durable or aggressive than the highest grades of steel wire. All Weiler stainless steel brushes are manufactured with Type 302 stainless wire, but select items are also available with Type 316 wire by special order.



Non-Ferrous Wire - Brass, bronze and aluminum wire are available in assorted Weiler industrial grade power brush items. These non-ferrous materials will not generate a spark in use, but they lack the durability of carbon steel and stainless steel wire. Due to their soft brushing action, these materials may also be used in special applications such as decorative finishing.



Animal Hair - Natural hair bristle is used primarily in miniature power brushes for scratch-free cleaning and polishing. Depending on the animal species and type of hair, this fill material can range from relatively stiff to relatively soft, making it suitable for a variety of applications from removing dust from optical lenses to buffing precious metals using abrasive compounds.



Vegetable Fiber - Tampico, a natural fiber produced from the Mexican agave plant, is a common natural fill material used in wet scrubbing and cleaning applications as well as buffing and polishing metals. It is heat, alkali and acid resistant. Its natural color is off-white but it may be dyed or bleached.



Synthetic - Nylon is typically the most durable synthetic bristle material for use in power brushes and can be used in a variety of applications due to its flexibility, high fatigue strength and resistance to abrasion, heat, acids and alkali. Polypropylene is less durable and used primarily in strip brushes.

STAINLESS STEEL BRUSHES

Weiler's stainless steel wire brushes are manufactured using wire drawn from Type 302 stainless steel. Although 302 stainless is typically a non-magnetic material, it is important to remember that the amount of cold-working that it experiences during the wire-drawing process causes it to become magnetic. For this reason, proper storage and handling of stainless steel brushes is critical to prevent cross-contamination and "after rust" issues. Type 302 is widely used in the manufacture of power brushes for its relative durability

and aggressive action as well as for its austenitic properties that insure the corrosion resistance of the materials on which it is applied. The use of a different grade of stainless steel wire is typically required in critical weld preparation and cleaning applications, but it will not address "after rust" and other cross-contamination issues. To insure the corrosion resistance of any stainless steel surface after brushing, passivating it with a 10-20% solution of nitric acid is recommended.

WORK SAFER WITH PROPER BRUSH USAGE

Weiler products are designed and manufactured to the strictest standards to ensure the highest level of quality and safety. But safety doesn't stop there; raising awareness of basic safety practices and thinking about safety before the job starts — and after the job is complete — can help curb accidents and injuries in the shop. That's why Weiler offers customers a Safety Training Program based on the **SPOT (Speed & Size, Pressure, Orientation, Time)** methodology to help promote safe and proper product usage.

THINK SPOT.
WHEN USING ABRASIVES & BRUSHES

Deploying our **SPOT Safety Training Program** in your facility helps improve safety, regardless of your application or work environment.

For **SPOT Safety Training** contact your Weiler representative.

SPEED & SIZE

- Power brushes, operate most effectively when the speed and pressure of the operation are properly matched to the demands of the application. In most operations, the highest speed and lightest pressure will ensure the fastest brushing action and longest brush life.
- Increasing brush speed increases the face hardness and brushing action; therefore, a fine wire brush rotating at a higher speed will often produce the same results as a coarser wire brush rotating at a slower speed. Finer wire operating at a higher speed is generally preferred and will provide a longer brush life.
- MSFS - Maximum Safe Free Speed (RPM) is the maximum speed at which the brushes may be used safely but is not necessarily the optimum speed for a given application. Operating speed should be determined by the application. When running a wire

brush, a rule of thumb is to run it a "mile a minute" or a minimum of 5,000 Surface Feet Per Minute (SFPM). However, never exceed the Maximum Safe Free Speed of the brush.

- Make sure spindle size and motor of machine are large enough to accommodate the diameter of brush to be used (see table on pg. 55).



Match the RPM rating of the power brush to the tool being used. The RPM of the tool should never exceed the RPM of the power brush.

RECOMMENDED SURFACE SPEEDS FOR BRUSHING APPLICATIONS

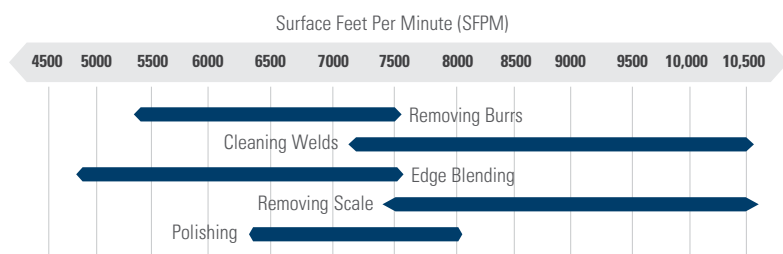

$$\text{SFPM} = \frac{\pi \text{ Dia. (Inches)} \times \text{RPM}}{12}$$

SURFACE SPEEDS (PERIPHERAL SPEED IN FT./MIN.)

RPM	Diameter (Inches)							
	2	3	4	6	8	10	12	15
1000	525	785	1,050	1,575	2,100	2,625	3,150	3,925
1500	785	1,175	1,575	2,350	3,150	3,925	4,725	5,900
1750	915	1,375	1,850	2,750	3,650	4,550	5,500	6,800
2500	1,300	1,950	2,625	3,925	5,250	6,550	7,850	9,825
3000	1,575	2,350	3,125	4,725	6,275	7,850	9,425	11,775
3450	1,800	2,700	3,600	5,400	7,200	9,000	11,000	13,500
4000	2,100	3,150	4,175	6,275	8,375	10,475	—	—
6000	3,125	4,700	6,275	9,425	—	—	—	—
10,000	5,250	7,850	10,500	—	—	—	—	—
15,000	7,850	11,775	15,750	—	—	—	—	—
20,000	10,450	15,700	20,950	—	—	—	—	—

Example: A 6" diameter wheel running at 3,450 RPM has a surface speed of 5,400 SFPM.

MINIMUM RECOMMENDED SPINDLE DIAMETER (From ANSI Standard B165.1)

Outside Dia. of Wheel Brush	Maximum Face Width of Wheel Brush	Minimum Outside Dia. of Spindle (Shaft)
2"	1/4"	1/4"
3"	3/4"	1/4"
3" (heavy-duty)	1"	3/8"
4"	1"	3/8"
6"	1-1/4"	1/2"
8"	1-1/4"	5/8"
10"	2"	3/4"
12"	3"	1"
14"	3"	1-1/4"
15"	3"	2"
16"	3"	2"

Note: These diameters are based on the wheel brush being mounted next to the supported end of the shaft rather than the unsupported end in order to minimize overhang.

RECOMMENDED MOTOR SIZES (Based on 1" Brush Face)

Brush Diameter	Motor Size	RPM
4"	1/4 HP	3,450
6"	1/2 HP	3,450
8"	3/4 HP	3,450
10"	1 HP	1,750
12"	1 HP	1,750
15"	1-1/2 HP	1,750

PRESSURE

Avoid excessive pressure when using a wire brush. Excessive pressure causes over-bending of the filaments and heat build-up resulting in filament breakage, rapid dulling and reduced brush life.

INSTEAD OF GREATER PRESSURE, TRY:

- A brush with more aggressive action (increase filament diameter, decrease trim length, different brush type, i.e.; knot type instead of crimped type).
- Higher surface speed (increase RPM or brush diameter)

Never exceed the recommended Maximum Safe Free Speed or RPM rating of the brush.



Correct
Wire Tips Doing the Work

Incorrect
Excessive Pressure Causes Wire Breakage

ORIENTATION

WORKING ANGLE BY BRUSH TYPE

Never stray more than 15° from the suggested working angles of the brush configurations below.

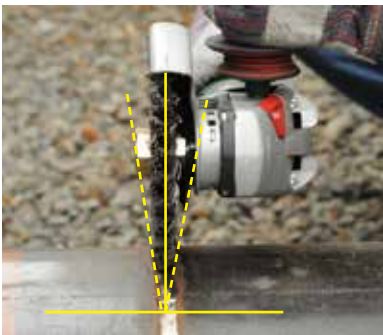

WHEEL +/- 15°



CUP +/- 15°



BEVEL +/- 15°

TIME

Reduce the time it takes to get the job done by choosing the most appropriate product configuration. (See page 53 for product selection information.)

SELF-SHARPENING OF WIRE WHEEL BRUSHES

When using wire wheel brushes without nuts, periodically reverse the direction of rotation to take advantage of the self-sharpening action that will result. Remove the brush from the spindle, flip the wire brush 180° and remount the brush securely.



Remove



Flip 180°



Remount Securely

POWER BRUSH TROUBLESHOOTING GUIDE

There are many variables in power brush applications. If the power brush you are using does not accomplish the desired results, select a solution from the suggestions below for your specific application or call Weiler's Application Engineering Hotline at 888-299-2777.

Problem	Recommended Solutions
Brush works too fast	<ul style="list-style-type: none"> • Select a brush with longer filaments and/or lower fill density • Select a brush with a smaller diameter wire • Select a brush with a narrower face and/or lower fill density • Select a brush with a smaller outside diameter • Operate the brush at a slower RPM
Brush works too slowly	<ul style="list-style-type: none"> • Select a brush with shorter filaments and/or higher fill density • Select a brush with a larger diameter wire • Select a brush with a wider face and/or higher fill density • Select a brush with a larger outside diameter • Operate the brush at a faster RPM
Brushing action rolls or peens the burr over instead of removing burr	<ul style="list-style-type: none"> • Select a brush with a larger diameter wire • Select a brush with shorter filaments and/or higher fill density • Operate the brush at a faster RPM • Replace the crimped wire brush with a knot wire brush
Finer final finish required	<ul style="list-style-type: none"> • Select a brush with longer filaments • Select a brush with a smaller diameter wire • Operate the brush at a higher RPM • Replace the wire brush with a nylon abrasive brush (Nylox-)
Coarser final finish required	<ul style="list-style-type: none"> • Select a brush with shorter filaments • Select a brush with a larger diameter wire • Operate the brush at a slower RPM
Non-uniform brushing action	<ul style="list-style-type: none"> • Select a brush with longer filaments • Select a brush with a larger diameter wire • Automate the operation to reduce human variables
Filaments break off	<ul style="list-style-type: none"> • Reduce applied pressure or engagement • Select a brush with a smaller diameter wire • Select a brush with a lower fill density
Short brush life	<ul style="list-style-type: none"> • Reduce applied pressure or engagement • Select a brush with a smaller diameter wire • Select a brush with a higher fill density

NEED HELP?

For more information and to schedule a consultation with a Weiler Process Solutions expert visit: weilerabrasives.com/wps.
To discuss specific requirements with a specialist call: 800-835.9999.



ARTICLE:

Learn how extending wire brush life creates operational savings.



KNOT WIRE WHEELS WITH ARBOR HOLE

Knot wire wheels with arbor holes are intended for use on straight grinders and stationary machines such as bench or pedestal grinders and buffing lathes. Featuring Weiler's individual knot hole construction, these radial brushes are available in heat-treated steel, Type 302 stainless steel, and bronze wire for use in a wide variety of applications.

APPLICATIONS

- Removing rust, scale and heavy corrosion
- Surface roughening and preparation
- Coating removal
- Removing excess molded rubber or plastic
- Heavy deburring

MADE IN
USA
WITH GLOBAL
MATERIALS



Removing rubber coating from a hydraulic hose.

P **STANDARD TWIST WHEELS** provide heavy-duty brushing action with some flexibility; ideal for demanding cleaning applications on somewhat irregular surfaces.



Dia.	Wire Size	Arbor Hole	No. of Knots	Face Width	Trim Length	Max. AH Avail.	Thickness at Face Plates	Max. RPM	Std. Pack	Item Number	
										Steel	Stainless
3"	.0118	1/2"-3/8"	20	3/8"	5/8"	1/2"	7/16"	25,000	10	08004	08254
	.014									08014 ■ 08264 ■	
	.020									08024 ▲ 08274	
4"	.0118	1/2"-3/8"	24	1/2"	7/8"	1/2"	7/16"	20,000	10	08034	08284
	.014									08044 ■ 08294	
	.020									08064 08314	
4"	.014	5/8"-1/2"	24	1/2"	7/8"	7/8"	7/16"	20,000	10	08045	—
6"	.0118	5/8"-1/2"	24	1/2"	1-3/8"	1-1/4"	9/16"	9,000	10	08075	08325
	.014									08085 ■ —	
	.016									08095 08345	
	.023									08105 —	
6"	.016	5/8"-1/2"	30	5/8"	1-1/4"	1-1/4"	5/8"	9,000	5	08975	—
7"	.014	5/8"	24	5/8"	1-7/8"	1-1/4"	9/16"	9,000	2	08835	—
8"	.0118	5/8"	38	5/8"	1-5/8"	2"	1/2"	6,000	2	08125	08375
	.014									08135 —	
	.016									08145 08395	
.023	08155 —										
8"	.014	3/4"	38	5/8"	1-5/8"	2"	1/2"	6,000	2	08138	—
10"	.014	3/4"	52	3/4"	1-3/4"	2-1/2"	3/4"	4,500	2	08178	—
10"	.014	1-1/4"★	52	3/4"	1-3/4"	2-1/2"	3/4"	4,500	2	08179	—
	.016									08189	—
12"	.014	1-1/4"★	52	3/4"	2-3/4"	2-1/2"	11/16"	3,600	1	08209	—
	.016									08219	—
12"	.014	2"◆	52	3/4"	2-3/4"	2-1/2"	11/16"	3,600	1	08200-14	—
12"	.020	1-1/4"★	56	5/8"	2-3/4"	3"	13/16"	4,500	2	09719	—
12"	.023	2"◆	66	3/4"	2-1/4"	3"	13/16"	5,000	2	09870	—

★ 5/16" x 5/32" Double Keyway

◆ 1/2" x 1/4" Double Keyway

▲ Available in non-sparking bronze wire, see page 102-103 for details.

■ Packaged product available. See pages 141-142 for details.

BOLD BLACK ITEM numbers indicate color-coded brushes for easy identification.



08264



08085



08189

COATED ABRASIVES

NON-WOVEN ABRASIVES

NYLON BRUSHES

PACKAGED ITEMS

MAINTENANCE

V **WOLVERINE® STANDARD TWIST WHEELS** provide aggressive brushing action for general-purpose surface cleaning applications.



Dia.	Wire Size	Arbor Hole	No. of Knots	Face Width	Trim Length	Max. AH Avail.	Thickness at Face Plates	Max. RPM	Std. Pack	Item Number	
										Steel	Stainless
3"	.014	1/2"-3/8"	20	3/8"	3/8"	1/2"	7/16"	25,000	10	36290	—
4"	.014	1/2"-3/8"	20	5/8"	7/8"	1/2"	9/16"	20,000	10	36226 •	—
			24							—	36293 •
6"	.014	5/8"-1/2"	24	1/2"	1-1/4"	5/8"	9/16"	9,000	10	36227	—
8"	.014	5/8"	34	9/16"	1-5/8"	5/8"	1/2"	6,000	2	36228 •	—
			38							36279	—

• Non-stock product, contact Customer Service for lead times and minimum order quantities.

NOTE

If a different arbor hole is required (than listed in the tables) refer to Arbor Hole Table shown on Pg. 61.



36226



36227



08339

P STANDARD TWIST WHEELS - High Density & Extra High Density - Engineered for maximum performance in production applications; for use on automated equipment such as dedicated gear deburring machines.

Diameter	Wire Size	Arbor Hole	Face Width	Trim Length	Thickness at Face Plates	Max. RPM	Standard Pack	Item Number Steel
80 KNOTS								
14"	.0118	1-1/4"★	3/4"	2-1/2"	5/8"	5,000	2	08309
	.0118	2"◆						08300
	.014	1-1/4"★						08319●
	.014	2"◆						08310
	.020	1-1/4"★						08339
	.020	2"◆						08330●
15"	.014	2"◆	3/4"	3"	5/8"	5,000	2	09980●
	.020	2"◆						09990
90 KNOTS								
14"	.014	2"◆	3/4"	1-1/2"	5/8"	5,000	2	09020●
	.016	2"◆						09790●
	.016	1-1/4"★						09799
	.020	2"◆						09800●
	.020	1-1/4"★						09809●
	.020	1-1/4"★						09049●
15"	.020	2"◆	3/4"	2"	5/8"	5,000	2	09840
	.020	2"◆						09080●

★ 5/16" x 5/32" Double Keyway ◆ 1/2" x 1/4" Double Keyway * Economy
● Non-stock product, contact Customer Service for lead times and minimum order quantities.



09460

09104

P STANDARD TWIST WHEELS - Two Section - Provide heavy-duty brushing action with some flexibility; feature a double row of knotted wire for a wider brush face.



Diameter	Wire Size	Arbor Hole	No. of Knots	Face Width	Trim Length	Thickness at Face Plates	Max. RPM	Standard Pack	Item Number Steel
3"	.0118	1/2"-3/8"	40	3/4"	5/8"	3/4"	22,000	5	09104
4"	.0118	1/2"-3/8"	48	3/4"	7/8"	3/4"	20,000	5	09134
	.016								09160
6"	.0118	2"	60	7/8"	1-3/8"	7/8"	8,000	5	09180
	.016								09410
	.023								09430
8"	.0118	2"	76	1"	1-5/8"	1"	6,000	1	09440
	.016								09460
	.023								09480
10"	.0118	2"	104	1-1/4"	1-3/4"	1-1/4"	4,500	1	09490
	.016								09510
	.023								09530
12"	.0118	2"	104	1-1/4"	2-3/4"	1-1/4"	3,600	1	09540
	.016								
	.023								

See Metal Adapters on page 76 for brushes with 2" arbor holes.



94000

P STANDARD TWIST WHEEL - Four Section - Featuring four rows of knotted wire; for use in automated cleaning processes such as removing light mill scale from metal rod and wire.

Diameter	Wire Size	Arbor Hole	No. of Knots	Face Width	Trim Length	Thickness at Face Plates	Max. RPM	Standard Pack	Item Number Steel
12"	.014	2"	208	2"	2-3/4"	1-3/4"	3,600	1	94000

See Metal Adapters on page 76 for brushes with 2" arbor holes.

P **CABLE TWIST WHEELS** provide maximum brushing action with minimal flexibility; ideal for demanding cleaning and coating removal applications on relatively smooth surfaces.



Dia.	Wire Size	Arbor Hole	No. of Knots	Face Width	Trim Length	Max. AH Avail.	Thickness at Face Plates	Max. RPM	Std. Pack	Item Number	
										Steel	Stainless
4"	.020	1/2"-3/8"	24	1/4"	7/8"	1/2"	7/16"	20,000	10	08534 ■	—
6"	.023	5/8"-1/2"	24	3/8"	1-3/8"	1-1/4"	9/16"	9,000	10	08565 ■	08695*
8"	.023	5/8"	38	1/2"	1-5/8"	2"	1/2"	6,000	2	08615	—
		3/4"★	52	1/2"	1-3/4"	2-1/2"	3/4"	4,500	2	08878	—
10"	.023	1-1/4"★	52	1/2"	1-3/4"	2-1/2"	3/4"	4,500	2	08879	—
		1-1/4"★	52	7/16"	2-3/4"	3"	3/4"	3,600	2	09379 ●	—

If a different arbor hole is required (than listed) refer to the Arbor Hole Variations Table on page 61. ★ 5/16" x 5/32" Double Keyway *Standard Pack 2

■ Packaged product available. See pages 141-142 for details.

● Non-stock product, contact Customer Service for lead times and minimum order quantities.

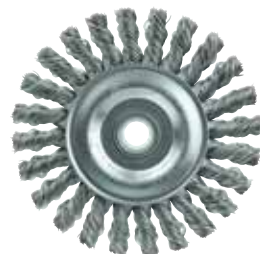

08534



94008

P **CABLE TWIST WHEEL - Four Section** - Featuring four rows of tightly knotted wire; for use in demanding automated applications such as cleaning the OD of drill pipe and other oilfield tubular goods.

Dia.	Wire Size	Arbor Hole	No. of Knots	Face Width	Trim Length	Max. AH Avail.	Thickness at Face Plates	Max. RPM	Std. Pack	Item Number
10"	.023	2"	208	1-3/4"	1-3/4"	2"	1-7/8"	4,500	1	94008

P **JOINT & CRACK CLEANING WHEELS** feature heavy-duty construction and an extra long trim length for cleaning expansion joints and cracks in concrete and asphalt.



Dia.	Wire Size	Arbor Hole	No. of Knots	Face Width	Trim Length	Thickness at Face Plates	Max. RPM	Standard Pack	Item Number
10"	.035	1" with two drive holes*	38	3/8"	2-5/8"	1/2"	5,000	2	94199 ●
12"	.035	1" with two drive holes*	38	3/8"	3-5/8"	1/2"	5,000	2	94224
12"	.035	1" with two drive holes*	52	3/8"	2-3/4"	3/4"	6,000	2	94026

*Drive holes are 3/8" diameter with 1/4" x 1/8" double keyway.

● Non-stock product, contact Customer Service for lead times and minimum order quantities.

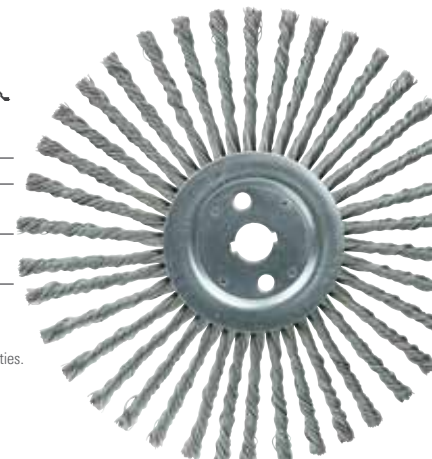

94224

ADAPTER for mounting Joint & Crack Cleaning Wheels onto a 20mm arbor.

For Brush Arbor Hole Size	Adapted Arbor Hole Size	Standard Pack	Item Number
1"	20mm	10	04455



04455

Cleaning a crack on an airport runway with a joint & crack cleaning brush prior to filling.



NOTE

If a different arbor hole is required (than listed in the tables) refer to Arbor Hole Table shown on Pg. 61.

Key:

P Performance line Industrial Grade

V Value line Professional Grade

WHY WEILER
BONDED ABRASIVES
COATED ABRASIVES

NYLON BRUSHES

PACKAGED ITEMS

MAINTENANCE

KNOT WIRE WHEELS WITH NUT

MADE IN
USA
WITH GLOBAL
MATERIALS

Knot wire wheels with a threaded nut are intended for use primarily on small and large right angle grinders. Featuring Weiler's individual knot hole construction, these radial brushes are available in heat-treated steel, Type 302 stainless steel and bronze wire for use in a wide variety of applications.

APPLICATIONS

- Removing powder-coating, epoxy-based paints, and rubberized coatings
- Weld preparation and cleaning
- Cleaning scale and heavy corrosion
- Removing heavy burrs from large pieces after cutting



Cleaning a corner weld with a bevel brush.

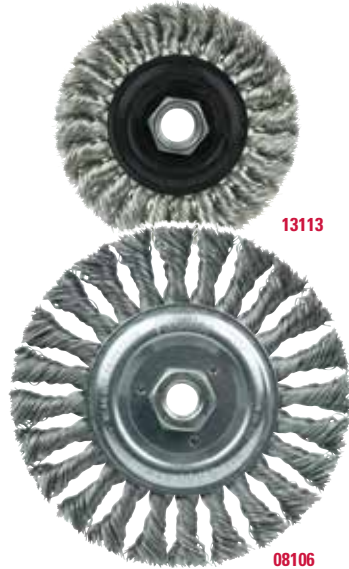

P **STANDARD TWIST WHEELS** provide heavy-duty brushing action with some flexibility; ideal for deburring and demanding cleaning applications on somewhat irregular surfaces.



Dia.	Wire Size	Arbor Hole	No. of Knots	Face Width	Trim Length	Max. RPM	Std. Pack	Item Number	
								Steel	Stainless
3"	.014	3/8"-24 UNF	20	3/8"	5/8"	25,000	5	13201	13208 •
4"	.014	M10 x 1.25	24	1/2"	7/8"	20,000	5	13100 •	13107 •
		M10 x 1.50						13101 •	13108 •
		M14 x 2.0						13102	13109 •
		3/8"-24 UNF						13103	13110
		1/2"-13 UNC						13105	—
5/8"-11 UNC	13106 ■	13113 ■							
4"	.020	M10 x 1.25	24	1/2"	7/8"	20,000	5	13114 •	—
		M10 x 1.50						13115 •	—
		M14 x 2.0						13116 •	—
		3/8"-24 UNF						13117	—
		1/2"-13 UNC						13119 •	—
		5/8"-11 UNC						13120 ▲ ■	—
		—						—	08346
08106	—	—							
6"	.016 .023	5/8"-11 UNC	24	1/2"	1-3/8"	9,000	5	—	08346
								08106	—

■ Packaged product available. See pages 141-142 for details.

• Non-stock product, contact Customer Service for lead times and minimum order quantities.

▲ Available in non-sparking bronze wire, see page 102-103 for details.

■ **BOLD BLACK ITEM** numbers indicate color-coded brushes for easy identification.

V **WOLVERINE® STANDARD TWIST WHEELS** provide an aggressive brushing action for general purpose deburring, cleaning, and surface preparation applications.



Dia.	Wire Size	Arbor Hole	No. of Knots	Face Width	Trim Length	Max. RPM	Std. Pack	Item Number	
								Steel	Stainless
4"	.014	5/8"-11 UNC	20	1/2"	7/8"	20,000	5	36212	36213
		M10 x 1.25						36215 •	—
		M10 x 1.50						36216 •	—
		M14 x 2.0						36217 •	—
		—						36224	—
6"	.025	5/8"-11 UNC	24	3/4"	1-1/4"	11,000	10	36224	—

• Non-stock product, contact Customer Service for lead times and minimum order quantities.

P **CABLE TWIST WHEELS** provide maximum brushing action with minimal flexibility; ideal for demanding cleaning and surface preparation applications on relatively smooth surfaces.



Dia.	Wire Size	Arbor Hole	No. of Knots	Face Width	Trim Length	Max. RPM	Std. Pack	Item Number	
								Steel	Stainless
4"	.020	M10 x 1.25	24	1/4"	7/8"	20,000	5	13261 •	—
		M10 x 1.50						—	13272 •
		5/8"-11 UNC						13266 ■	13276

■ Packaged product available. See pages 141-142 for details.

• Non-stock product, contact Customer Service for lead times and minimum order quantities.

V **WOLVERINE CABLE TWIST WHEELS** provide the most aggressive brushing action for general purpose cleaning and surface preparation applications.



Dia.	Wire Size	Arbor Hole	No. of Knots	Face Width	Trim Length	Max. RPM	Std. Pack	Item Number	
								Steel	Stainless
4"	.020	5/8"-11 UNC	20	1/4"	7/8"	20,000	5	36255	36257 •
		M10 x 1.50						—	36258 •
		M10 x 1.25						—	—

• Non-stock product, contact Customer Service for lead times and minimum order quantities.

P **STANDARD TWIST BEVEL BRUSHES** are saucer-shaped radial wheels that provide a heavy-duty brushing action with some flexibility; ideal for cleaning fillet welds and into corners.



Diameter	Wire Size	Arbor Hole	No. of Knots	Face Width	Trim Length	Max. RPM	Std. Pack	Item Number	
								Steel	Stainless
4"	.014	M10 x 1.25	20	3/8"	3/4"	12,500	1	13401	—
		M10 x 1.50						13402	—
		5/8"-11 UNC						13406	13416
4"	.020	M14 x 2.0	20	3/8"	3/4"	12,500	1	13423	—
		5/8"-11 UNC						13426	13436
4-1/2"	.014	5/8"-11 UNC	20	3/8"	1"	12,500	1	13456	13466
4-1/2"	.020	5/8"-11 UNC	20	3/8"	1"	12,500	1	13476	13486

• Non-stock product, contact Customer Service for lead times and minimum order quantities.



13456

P **THREADED ADAPTERS** for mounting brushes with a 5/8"-11 UNC nut to other threaded spindles.

Fixed Thread Size	Adapted Thread Size	Standard Pack	Item Number
5/8"-11 UNC	M10 x 1.25	10	07771 ■
5/8"-11 UNC	M10 x 1.50	10	07772 ■
5/8"-11 UNC	3/8"-16 UNC	10	07769
5/8"-11 UNC	3/8"-24 UNF	10	07746

■ Packaged product available. See pages 141-142 for details.



07771

KNOT WIRE WHEELS WITH STEM

MADE IN USA
WITH GLOBAL MATERIALS

Knot wire wheels with a permanently attached 1/4" stem or shank are primarily intended for use on high-speed die grinders. Although they can also be mounted onto a drill, the speed and power of that tool will limit the effectiveness of the brush. Featuring Weiler's individual knot hole construction, these radial wheels are available in heat-treated steel and Type 302 stainless steel wire.

APPLICATIONS

- Removing powder-coating, epoxy-based paints, and rubberized coatings
- Weld preparation and cleaning
- Cleaning scale and heavy corrosion
- Removing heavy burrs from large pieces after cutting

P **STANDARD TWIST WHEELS 1/4" Stem** - Provide heavy-duty brushing action with some flexibility; ideal for deburring and demanding cleaning applications on somewhat irregular surfaces.

Diameter	Wire Size	No. of Knots	Face Width	Trim Length	Max. RPM	Standard Pack	Item Number	
							Steel	Stainless
3-1/4"	.0118	20	3/8"	5/8"	25,000	5	17680	—
	.014						17681 ■	17684
	.020						17682	—
4"	.0118	24	1/2"	7/8"	20,000	5	17686	—
	.014						17687 ■	17691
	.020						17689	—

■ Packaged product available. See pages 141-142 for details.



17684

"We get a competitive edge with Weiler because their prices are competitive but they last far longer."

- Jim Martin, Vice President, Karnel Incorporated



Key:

P Performance line
Industrial Grade

V Value line
Professional Grade

WHY WEILER
BONDED ABRASIVES
COATED ABRASIVES
NON-WOVEN ABRASIVES
POWER BRUSHES
NYLON BRUSHES
PACKAGED ITEMS
MAINTENANCE

WELD CLEANING BRUSHES

Weiler's stringer bead wheels are the most effective weld cleaning tools for the most demanding users. Our premium weld cleaning brushes are manufactured to the most stringent quality standards, utilizing the highest quality wire available. The twist puts all the sharp tips at the end of the knots, making them the fastest, most aggressive weld cleaning tools on the market.



UP TO
2X
THE LIFE

ROUGHNECK MAX

MADE IN
USA
WITH GLOBAL
MATERIALS

Roughneck Max wheels have been re-engineered to MAXimize life, efficiency and consistency. But that is only a small part of what makes this brush better...

- **Smooth & Responsive** — Improved feel and comfort during use makes brush operation effortless
- **No Long Wire Breakage** — Stronger, sharper wire delivers consistency and performance you can count on
- **Cleans 40% Faster** — Unmatched cleaning power compared to competitors
- **Less Force Required** — The operator can apply less pressure to clean, letting the wire do the work

P **ROUGHNECK® MAX STRINGER BEAD WHEELS** deliver unmatched weld cleaning performance by maximizing life, efficiency and consistency. The 4" brushes are recommended for cleaning root pass welds, surface prep and other cleaning applications.



Diameter	Wire Size	Arbor Hole	No. of Knots	Face Width	Trim Length	Thickness at Face Plates	Max. RPM	Std. Pack	Item Number	
									Steel	Stainless
4"	.020	5/8"-11 UNC	32	3/16"	7/8"	7/16"	20,000	5	13131 ■	13138 ■

■ Packaged product available. See pages 141-142 for details.

BOLD BLACK ITEM numbers indicate color-coded brushes for easy identification.



13138



13124

ROUGHNECK

MADE IN
USA
WITH GLOBAL
MATERIALS

P **ROUGHNECK STRINGER BEAD WHEELS** are the standard for high-performance weld cleaning brushes. Narrow face brushes are suitable for cleaning root and hot passes and reaching into corners; wider face wheels can be used for cleaning filler and cap passes as well as for other surface prep and cleaning applications.



Diameter	Wire Size	Arbor Hole	No. of Knots	Face Width	Trim Length	Thickness at Face Plates	Max. RPM	Std. Pack	Item Number	
									Steel	Stainless
Root Pass Brushes										
4"	.020	1/2"-3/8" M10 x 1.25 M10 x 1.50 M14 x 2.0 3/8"-24 UNF 1/2"-13 UNC	32	3/16"	7/8"	7/16"	20,000	5	13124	08954*
									13125 ■	13132
									13126	—
									13127	13134
									13128	13135
									13130	13137
4-1/2"	.020	5/8"-11 UNC 7/8"	38	3/16"	13/16"	3/8"	15,000	5	13232	13238
									13234	13249
5"	.020	5/8"-11 UNC 7/8"	38	3/16"	7/8"	3/8"	12,500	5	08756	08806
									08750	—
6"	.020	5/8"-11 UNC	48	3/16"	1-1/8"	3/8"	12,500	10	08766†	—
					1-3/8"	3/8"			—	08786†•
					1-1/8"	7/16"			09400 ■	09500
					1-1/8"	7/16"			09000 ■	09200
7"	.020	5/8"-11 UNC	56 76	3/16"	1-1/8"	7/16"	9,000	10	09100	—
Filler Pass Brushes										
5"	.023	5/8"-11 UNC	24	1/2"	7/8"	3/8"	12,500	5	09856	09866
6"	.023	5/8"-1/2"	24	1/2"	1-3/8"	9/16"	12,500	10	08775	—
		5/8"-11 UNC	24	1/2"	1-3/8"	9/16"			08776 ■	08796•
		5/8"-11 UNC	30	1/2"	1-1/4"	5/8"			08916	08926•
		5/8"-11 UNC	30	5/16"	1-3/8"	1/2"			09386	09396•

NOTE

If a different arbor hole is required (than listed in the tables) refer to Threaded Adapter Chart shown on Pg. 71.

† Light Duty • Standard Pack 5 * Standard Pack 10 ■ Packaged product available. See pages 141-142 for details.

THE DUALLY®



MADE IN USA
WITH GLOBAL MATERIALS

- **Maximum Cleaning Action** — Featuring a knot twist with the most aggressive cutting action, the new dual-hex nut makes it easier for the user to regularly switch mounting position and keep the brush running at peak performance.
- **Long Wheel Life** — Utilizing the highest quality heat-treated Steel wire and construction that virtually eliminates knot movement, the Dually delivers smooth operation and long life for the lowest cleaning costs in demanding multi-pass welding applications such as pipeline construction.
- **Improved User Safety** — The one-piece, dual-hex nut is designed to provide adequate tool clearance so there is no need to remove the guard from the grinder in order to change the position of the wheel.



Removing weld slag before the next weld pass.

P **DUALLY® STRINGER BEAD WHEELS** feature a dual-hex nut design that simplifies periodic flipping of the wheel for maximum cleaning action, long life, and safer use.

Diameter	Wire Size	Arbor Hole	No. of Knots	Face Width	Trim Length	Thickness at Face Plates	Max. RPM	Standard Pack	Item Number	
									Steel	Stainless
Root Pass Brushes										
4-1/2"	.020	5/8"-11 UNC	38	3/16"	13/16"	3/8"	15,000	5	79801	79811
5"	.020	5/8"-11 UNC	38	3/16"	7/8"	3/8"	12,500	5	79802	79812 •
6"	.020	5/8"-11 UNC	56	3/16"	1-1/8"	7/16"	12,500	5	79805	79815
7"	.020	5/8"-11 UNC	56	3/16"	1-1/8"	7/16"	9,000	5	79800	79810 •
Filler Pass Brushes										
5"	.023	5/8"-11 UNC	24	1/2"	7/8"	3/8"	12,500	5	79803	79813 •
6"	.023	5/8"-11 UNC	30	1/2"	1-1/4"	5/8"	12,500	5	79804	79814

• Non-stock product, contact Customer Service for lead times and minimum order quantities.



79802

COATED ABRASIVES

P **POLYFLEX™ ENCAPSULATED WELD CLEANING WHEELS** Black Elastomer*

Feature a heat-stabilized encapsulation that gradually wears away to expose a consistent short trim for higher aggression, controlled brushing action, and longer life; suitable for cleaning hot welds.

Diameter	Wire Size	Arbor Hole	No. of Knots	Face Width	Trim Length	Thickness at Face Plates	Max. RPM	Standard Pack	Item Number	
									Steel	
4"	.020	5/8"-11 UNC	32	3/16"	7/8"	7/16"	20,000	5	35800	▲
6"	.014	5/8"-11 UNC	—	3/16"	1-7/16"	3/8"	9,000	5	35206	◆
7"	.020	5/8"-11 UNC	56	3/16"	1-1/8"	7/16"	9,000	10	35600	▲
	.014									

* See Elastomer Color Code Chart on page 61 for more information. ▲ Stringer Bead Wheels ◆ Crimped wire



35800



35216

NYLON BRUSHES

WOLVERINE®

Wolverine wheels offer professional grade quality and performance at a great value. Re-engineered, these 32 knot wheels deliver 20% MORE life while maintaining aggressive cleaning power for weld cleaning applications.

MADE IN USA
WITH GLOBAL MATERIALS

V **WOLVERINE® STRINGER BEAD WHEELS** have upgraded to 32 knots to deliver 20% longer life.

The 4" wheels are manufactured using similar product construction and to the same exacting standards as other Weiler weld cleaning brushes; they have been engineered for cost-effective use in less demanding cleaning applications.

Diameter	Wire Size	Arbor Hole	No. of Knots	Face Width	Trim Length	Thickness at Face Plates	Max. RPM	Standard Pack	Item Number	
									Steel	Stainless
4"	.020	5/8"-11 UNC	32	3/16"	7/8"	7/16"	20,000	5	36218	36219

BOLD BLACK ITEM numbers indicate color-coded brushes for easy identification.



36219

PACKAGED ITEMS

V **WOLVERINE STRINGER BEAD WHEELS** are manufactured using similar product construction and to the same exacting standards as other Weiler weld cleaning brushes; they have been engineered for cost-effective use in less demanding applications.



Dia.	Wire Size	Arbor Hole	No. of Knots	Face Width	Trim Length	Max. RPM	Standard Pack	Item Number	
								Steel	Stainless
5"	.020	5/8"-11 UNC	38	3/16"	7/8"	12,500	5	36295	36296
6"	.020	5/8"-11 UNC	48	1/4"	1-1/4"	12,500	10	36225	—
			38	3/16"	1-3/8"	—	36307†	—	
7"	.020	5/8"-11 UNC	56	3/16"	1-1/8"	9,000	10	36297	—

† Light Duty

36297



CRIMPED WIRE WHEELS WITH ARBOR HOLE

MADE IN
USA
WITH GLOBAL
MATERIALS

Crimped Wire Wheels with Arbor Hole are intended for use on straight grinders and stationary machines such as bench or pedestal grinders and buffing lathes. Featuring Weiler's solid ring construction, these radial brushes are available in heat-treated steel, Type 302 stainless steel and brass wire for use in a wide variety of applications.

APPLICATIONS

- Removing rust and light corrosion
- Paint removal and surface cleaning
- Decorative finishing
- Removing heat discoloration
- Light deburring



Removing heat discoloration from a stainless steel canister.



NOTE

If a different arbor hole is required (than listed in the tables) refer to Arbor Hole Table shown on Pg. 61.

P **CRIMPED WIRE WHEELS - Narrow Face** - provide a flexible brushing action and consistent performance for demanding light-duty cleaning and deburring applications.



Dia.	Wire Size	Arbor Hole	Face Width	Trim Length	Max. AH Avail.	Thickness at Face Plates	Max. RPM	Std. Pack	Item Number	
									Steel	Stainless
3"	.006	1/2"-3/8"	7/16"	1/2"	3/4"	7/16"	12,500	2	00204	00244 •
	.008								—	
	.0118								00234	00264 •
	.014								00274	—
4"	.006	1/2"-3/8"	1/2"	7/8"	3/4"	7/16"	12,500	2	00104	00154
	.006								5/8"-1/2"	—
	.008								1/2"-3/8"	—
	.0095	5/8"-1/2"	—	—						
	.0118		1/2"-3/8"	00134	00184					
	.0118		—	—						
.014	—	00135	—							
.014	—	00144	—							
6"	.006	5/8"-1/2"	3/4"	1-7/16"	1-1/4"	7/16"	6,000	10	01035 ▲	01675*
	.008								—	
	.008	1-1/4" ★	—	—						
	.0104		—	01695*						
	.0118		—	01705*						
.014	5/8"-1/2"	—	—							
.014	—	—	—							
6"	.0118	3/4"	3/4"	1-7/16"	1-1/4"	7/16"	6,000	10	01068	—
8"	.006	5/8"	3/4"	2-1/16"	1-1/4"	1/2"	6,000	2	01135	01775
	.008								—	
	.0104	3/4"	—	—						
	.0118		—	01795						
	.014		—	01805						
.014	—	01175 ■	—							
8"	.006	3/4"	3/4"	2-1/16"	1-1/4"	1/2"	6,000	2	01138	—
	.008								—	
	.0104								—	
	.0118								—	
	.014								—	
8"	.0118	1-1/4" ★	3/4"	2-1/16"	1-1/4"	1/2"	6,000	2	—	01809
	.014								—	
	.014								01179	—
10"	.006	3/4"	3/4"	2-1/2"	2"	5/8"	4,000	2	01228 •	—
	.0104								—	
	.0118	1"	—	—						
	.014		—	01898						
	.014		—	01250-12	—					
.014	1-1/4" ★	3/4"	2-1/2"	2"	5/8"	4,000	2	01259	—	
12"	.006	1-1/4" ★	3/4"	2-15/16"	2-1/2"	1/2"	3,000	2	01299	01939
	.0104								01309 •	01949 •
	.0118								01319	—
	.014								01329	—
12"	.014	2" ◆	3/4"	2-15/16"	2-1/2"	1/2"	3,000	2	01320-14 •	—
	.0118								—	
15"	.0118	1-1/4" ★	3/4"	4-7/16"	2-1/2"	1/2"	3,000	2	01339 •	—
	.014								—	
									01349	—

◆ 1/2" x 1/4" Double Keyway

★ 5/16" x 5/32" Double Keyway

● 1/4" x 1/8" Double Keyway

▲ Available in non-sparking brass wire, see page 102-103 for details.

* Standard Pack 2

■ Packaged product available. See pages 141-142 for details.

• Non-stock product, contact Customer Service for lead times and minimum order quantities.

V **WOLVERINE® CRIMPED WIRE WHEELS - Narrow Face** - provide a flexible brushing action and cost-effective performance in general purpose cleaning and deburring applications.

Dia.	Wire Size	Arbor Hole	Face Width	Trim Length	Max. AH Avail.	Max.RPM	Std. Pack	Item Number	
								Steel	Stainless
4"	.014	1/2"-3/8"	1/2"	3/4"	1/2"	6,000	2	36262	—
6"	.014	5/8"-1/2"	3/4"	1-1/4"	5/8"	6,000	2	36200	36201 •
8"	.014	5/8"	3/4"	2"	5/8"	6,000	2	36205	—

• Non-stock product, contact Customer Service for lead times and minimum order quantities.



36205

35105

P **POLYFLEX™ ENCAPSULATED CRIMPED WIRE WHEELS** feature an encapsulation that gradually wears away to expose a consistent short trim for higher aggression, controlled brushing action, and longer life.

Dia.	Wire Size	Arbor Hole	Face Width	Trim Length	Max. AH Avail.	Thickness at Face Plates	Max. RPM	Standard Pack	Item Number Steel
Burgundy Elastomer* - Standard									
4"	.0095	1/2"-3/8"	3/8"	7/8"	3/4"	7/16"	6,000	2	35084
6"	.0104	5/8"-1/2"	1/2"	1-7/16"	1-1/4"	7/16"	6,000	2	35105
	.014								35117 •
8"	.014	5/8"	1/2"	2-1/16"	1-1/2"	1/2"	6,000	2	35135
Orange Elastomer* - Heavy-Duty									
6"	.0104	5/8"-1/2"	1/2"	1-7/16"	1-1/4"	7/16"	6,000	2	35520 •

* See Elastomer Color Code chart on page 61 for more information.

• Non-stock product, contact Customer Service for lead times and minimum order quantities.



35520

P **BENCH GRINDER WHEELS** feature a shorter trim length, narrower face width, and the same durable construction as other Weiler crimped wire wheels; designed specifically for use on small bench grinders for reduced flaring and long life in a broad range of applications.

Dia.	Wire Size	Arbor Hole	Face Width	Trim Length	Max. AH Avail.	Thickness at Face Plates	Max. RPM	Standard Pack	Item Number Steel
6"	.006	5/8"-1/2"	1/2"	1-1/16"	1-1/4"	7/16"	6,000	10	01085
	.008								01095
	.0118								01115
	.014								01125



01115

P **CRIMPED WIRE WHEELS - High Density** - Feature an increased fill density for greater brushing action, more consistent performance, and longer life in the most demanding applications requiring the flexibility of a crimped wire wheel.

Dia.	Wire Size	Arbor Hole	Face Width	Trim Length	Max. AH Avail.	Thickness at Face Plates	Max. RPM	Std. Pack	Item Number	
									Steel	Stainless
4-1/4"	.0118	5/8"-1/2"	3/4"	5/8"	3/4"	9/16"	6,000	1	01501 •	—
	.014								01502 •	—
6"	.008	5/8"-1/2"	3/4"	1-1/8"	1"	9/16"	6,000	1	01503 •	—
	.0118								01504 •	01508 •
	.014								01505 •	01509 •
	.020								01506 •	—
	01511								—	—
7"	.014	5/8"	7/8"	1-5/8"	1"	9/16"	6,000	1	01511	—
8"	.006	5/8"	7/8"	1-1/2"	1-1/4"	11/16"	4,500	1	01512 •	—
	.0104								01513 •	—
	.0118								01514	—
	.014								01515	—
	01517 •								—	—
10"	.0118	3/4"	1"	2-1/2"	1-1/4"	11/16"	4,500	2	01517 •	—
	.014								01518 •	—

• Non-stock product, contact Customer Service for lead times and minimum order quantities.



01501



01515

WHY WEILER

BONDED ABRASIVES

COATED ABRASIVES

NON-WOVEN ABRASIVES

POWER BRUSHES

NYLON BRUSHES

PACKAGED ITEMS

P

CRIMPED WIRE WHEELS - Medium Face - Provide a flexible brushing action and consistent performance for demanding light-duty cleaning and deburring applications; feature a wider face width to cover more area.



06020

06040

Dia.	Wire Size	Arbor Hole	Face Width	Trim Length	Thickness at Face Plates	Max. RPM	Standard Pack	Item Number	
								Steel	Stainless
4-1/2"	.0118	2"	15/16"	3/4"	7/8"	6,000	1	06020	—
6"	.006	2"	1"	1-1/8"	15/16"	6,000	1	06040	—
	.008							06050	—
	.0104							06060	06440
	.0118							06070	06450
	.014							06080	—
8"	.006	2"	1"	1-3/8"	1"	4,500	1	06090	—
	.0104							06100	—
	.0118							06110	06490
	.014							06120	—
	.020							06620	—
10"	.0118	2"◆	1-1/8"	2"	1"	3,600	1	06150	06530
	.014							06160	—
	.020							06170	—
								06200	—
12"	.0118	2"◆	1-1/4"	3"	1"	3,600	1	06180	—
	.014							06190	—
								06200	—
								06200	—

◆ 1/2" x 1/4" Double Keyway
For arbor hole reducing adapters, see Metal Adapter Table below.

V

WOLVERINE® CRIMPED WIRE WHEELS - Medium Face - Provide a flexible brushing action and cost-effective performance in general purpose cleaning and deburring applications; feature a wider face width to cover more area.



02335

Dia.	Wire Size	Arbor Hole	Face Width	Trim Length	Thickness at Face Plates	Max. RPM	Standard Pack	Item Number	
								Steel	Stainless
6"	.014	5/8"-1/2"	5/8"	1-1/16"	1/2"	6,000	1	02325	—
			3/4"	1-7/16"	7/16"			36203	—
7"	.014	5/8"	3/4"	1-9/16"	1/2"	6,000	1	02335	—

P

METAL ADAPTERS for Medium & Wide Face Brushes. Used in pairs & priced per pair.



03809

For Brush Arbor Hole Size	Adapted Arbor Hole Size	Item Number
2"	1/2"	03809
	5/8"	03810
	3/4"	03811
	7/8"	03824
	1"	03812
	1-1/4"	03813
	1-1/2"	03814

P

PLATER'S WIRE WHEELS feature a longer trim length and very small diameter fill material for producing fine satin and antique finishes on non-ferrous and precious metals.



22241

Dia.	Wire Size	Arbor Hole	Face Width	Trim Length	Number of Rows	Max. RPM	Std. Pack	Item Number	
								Brass*	Stainless
3"	.003	1/4"	1/2"	1"	2	6,000	12	22021	•
4"	.004	1/4"	1"	1-1/4"	4	4,000	5	22061	•
6"	.005	1/4"	1"	1-7/8"	4	3,600	1	22241	—

* Also available in carbon steel, stainless steel and nickel silver wire.

• Non-stock product, contact Customer Service for lead times and minimum order quantities.

P

CRIMPED WIRE WHEELS - Wide Face - Provide a flexible brushing action and consistent performance for demanding light-duty cleaning and deburring applications; feature a wider face width to cover more area.



Dia.	Wire Size	Arbor Hole	Face Width	Trim Length	Thickness at Face Plates	Max. RPM	Standard Pack	Item Number	
								Steel	Stainless
4-1/2"	.006	2"	1-1/4"	3/4"	7/8"	6,000	1	03000 •	—
	.0118							03010 •	—
	.014							03020 •	—
6"	.006	2"	1-1/4"	1-1/8"	1"	6,000	1	03030	03480
	.008							03040	—
	.0104							03050	—
	.0118							03060	03510
	.014							03070	03520
7"	.0118	2"	1-1/4"	1-5/8"	1"	6,000	1	03090	—
.014	03100							—	
8"	.006	2"	1-1/2"	1-3/8"	1-3/8"	4,500	1	03110	—
	.0095							03130 •	—
	.0118							03140	03590 •
	.014							03150	—
	.020							03160	—
10"	.0104	2"	2"	1-7/8"	1-5/8"	4,000	1	03180	—
	.0118							03190	—
	.014							03200	—
	.020							03210	—
	12"							.0118	2"
.014		03230	03680						
.020		1-11/16"	03240	—					



For arbor hole reducing adapters, see Metal Adapter Table on page 76.

• Non-stock product, contact Customer Service for lead times and minimum order quantities.

WHY WEILER
BONDED ABRASIVES
COATED ABRASIVES

V

WOLVERINE® CRIMPED WIRE WHEELS - Wide Face - Provide a flexible brushing action and cost-effective performance in general purpose cleaning and deburring applications; feature a wider face width to cover more area.



Dia.	Wire Size	Arbor Hole	Face Width	Trim Length	Thickness at Face Plates	Max. RPM	Standard Pack	Item Number	
								Steel	
6"	.014	2"-5/8"-1/2"	7/8"	1-1/8"	7/8"	6,000	1	06645	—
								36204	—
7"	.014	2"-5/8"-1/2"	7/8"	1-5/8"	7/8"	6,000	1	06655	—
8"	.014	2"-5/8"	1"	1-3/8"	1"	4,000	1	36206	—
10"	.014	2"-3/4"	1-1/8"	2"	1"	3,600	1	36265 •	—



• Non-stock product, contact Customer Service for lead times and minimum order quantities.

NON-WOVEN ABRASIVES
POWER BRUSHES

P

POLYFLEX™ ENCAPSULATED CRIMPED WIRE WHEEL - Wide Face - Burgundy*
Elastomer* - Features an encapsulation that gradually wears away to expose a consistent short trim for higher aggression, controlled brushing action, and longer life. Wider face width covers more area.



Dia.	Wire Size	Arbor Hole	Face Width	Trim Length	Thickness at Face Plates	Max. RPM	Std. Pack	Item Number	
								Steel	
6"	.0118	2"	1"	1-1/8"	1"	6,000	1	35160	—

* See Elastomer Color Code Chart on page 61 for more information.
For arbor hole reducing adapters, see Metal Adapter Table on page 76.



NYLON BRUSHES
PACKAGED ITEMS
MAINTENANCE

SMALL DIAMETER "COPPER CENTER" WHEELS

MADE IN
USA
WITH GLOBAL
MATERIALS



Removing casting flash from ductile-iron housing with an encapsulated brush.

Weiler's small diameter crimped wire wheels feature a plain arbor hole for use on a variety of portable tools and stationary machines. Featuring Weiler's solid ring construction for high-speed use, these radial brushes are available in heat-treated steel, Type 302 stainless steel, and brass wire.

APPLICATIONS

- Removing carbon build-up and deposits
- Removing rust and light corrosion
- Cleaning and finishing ID's and recessed areas
- Cleaning boiler tubes and internal passages
- Cleaning threads
- Wire stripping
- Light deburring

P **SMALL DIAMETER WHEELS** provide a flexible brushing action and consistent performance for light-duty cleaning and deburring applications requiring a small wheel.



Dia.	Wire Size	Arbor Hole	Face Width	Trim Length	Max. RPM	Standard Pack	Item Number	
							Steel	Stainless
1"	.003	1/4"	3/16"	1/4"	20,000	10	—	16461
	.005						—	16471
	.006						15071	—
1-1/4"	.003	1/4"	1/4"	3/8"	20,000	10	15101 ●	—
	.006						15111	16511 ●
	.008						—	16521
	.008						15732	—
1-3/8"	.006	1/4"	1/4"	3/8"	20,000	10	15131	—
	.008						15141	—
	.0104						15151	—
							—	—
1-1/2"	.006	3/8"	1/4"	7/16"	20,000	10	15302 ▲	—
	.008			7/16"			16712	
	.008			1/4"			—	
	.0104			3/8"			15753 ●	—
	.0118			3/8"			15322	—
	.014			7/16"			15332	—
				7/16"			15762	—
2"	.003	1/4"	3/8"	3/4"	20,000	10	99307	—
	.003			1/2"			15863 ●	—
	.006			1/2"-3/8"			—	16833
	.006			1/2"			15433 ▲	—
	.008			1/2"			15443	16843
	.0104			1/2"			15453	16853
	.0118			1/2"-3/8"			15463 ▲	—
	.014			1/2"-3/8"			15473	16873
				—			—	—
	2-1/2"			.0118			1/2"-3/8"	1/2"
.014		15523	—					
3"	.003	1/2"	5/8"	1"	20,000	10	99551	—
	.006			1/2"-3/8"			15533	16933
	.006			5/8"			15637	—
	.008			1/2"-3/8"			15543	16943
	.008			5/8"			15647 ●	—
	.0104			1/2"			15553	—
	.0118			1/2"-3/8"			15563	16963
	.0118			5/8"			15667 ●	—
	.014			1/2"-3/8"			15573 ▲	16973
	.014			5/8"			15677	—
4"	.006	1/2"	1/2"	1-1/2"	20,000	10	99553	—

▲ Available in non-sparking brass wire, see page 102-103 for details.

● Non-stock product, contact Customer Service for lead times and minimum order quantities.



P **POLYFLEX™ ENCAPSULATED SMALL DIAMETER WHEELS -**

Burgundy Elastomer* - Feature an encapsulation that gradually wears away to expose a consistent short trim for higher aggression, controlled brushing action, and longer life.



Diameter	Wire Size	Arbor Hole	Face Width	Trim Length	Max. RPM	Standard Pack	Item Number
							Steel
1-1/4"	.008	3/8"	3/16"	5/16"	20,000	10	35293
	.014						35294 •
2"	.0104	1/2"	1/4"	1/2"	20,000	10	35240
	.014						35070
3"	.008	1/2"	1/4"	1"	20,000	10	35808 •
	.0118						35250
	.014						35260

* See Elastomer Color Code chart on page 61 for more information.

• Non-stock product, contact Customer Service for lead times and minimum order quantities.



WIRE STRIPPING BRUSHES

Used for removing insulation from electrical wire. These brushes are made to order according to the specifications needed for the specific application.

When ordering, please specify:

- Brush diameter
- Brush face width
- Arbor hole size
- Wire size

For application assistance, call our Application Engineering Hotline toll-free at: 888-299-APPS (2777)



NOTE

- The adapters and drive arbors listed on this page are for use with small diameter wheel brushes only; do not attempt to use them with cutting or grinding wheels, buffing wheels, or any type of abrasive wheel or disc.
- Do not adapt a wheel brush for use on a shaft diameter less than that specified by ANSI B165.1 (see page 55) or exceed the maximum wheel diameter specified for a drive arbor.
- Never mount a drive arbor onto a tool that operates above the maximum RPM rating of either the arbor or the brush (whichever may be lower) and be sure that the stem of the arbor is properly secured in the collet or chuck before use.

P **DRIVE ARBORS** for mounting small diameter wheels into a collet or chuck.



Arbor Dia.	Stem Dia.	Stem Length	Length of Shaft	For Brushes with a Max. Dia. of	Overall Length	Max. RPM	Standard Pack	Item Number
Unthreaded Shaft								
1/4"	1/4"	1-1/8"	3/16"	2"	2-1/16"	20,000	5	07723
3/8"	1/4"	1-1/8"	3/16"	4"	1-15/16"	20,000	5	07722
Threaded Shaft								
1/4"	1/4"	1-1/16"	1-1/8"	2"	2-9/16"	20,000	5	07725
3/8"	1/4"	3/4"	3/4"	3"	1-9/16"	25,000	5	07727
3/8"	1/4"	1"	1-1/8"	3"	2-9/16"	20,000	5	07726
1/2"	1/4"	3/4"	3/4"	3"	1-3/4"	25,000	5	07724
1/2"	1/4"	7/8"	3/4"	3"	1-11/16"	20,000	5	07721
5/8"	1/4"	3/4"	3/4"	3"	1-13/16"	25,000	5	07729



P **PLASTIC ADAPTERS** for mounting small diameter wheels onto various arbor sizes.

Fixed Arbor Hole Size	Adapted Arbor Hole Size	Standard Pack	Item Number
1/2"	1/4"	10	04400
1/2"	3/8"	10	04401
5/8"	1/2"	10	04402



WHY WEILER BONDED ABRASIVES COATED ABRASIVES NON-WOVEN ABRASIVES POWER BRUSHES NYLON BRUSHES PACKAGED ITEMS MAINTENANCE

CRIMPED WIRE WHEELS WITH NUT OR STEM



Removing flash from a sand-cast iron engine block.

MADE IN
USA
WITH GLOBAL
MATERIALS

Crimped wire wheels with a threaded nut are intended for use primarily on small angle grinders. Featuring Weiler's solid ring construction, these radial brushes are available in heat-treated steel and Type 302 stainless steel wire.

APPLICATIONS

- Removing rust and light corrosion
- Surface prep prior to welding
- Removing heat discoloration and welding residuals

P **CRIMPED WIRE WHEELS** provide a flexible brushing action and consistent performance for demanding light-duty cleaning and deburring applications.



Dia.	Wire Size	Arbor Hole	Face Width	Trim Length	Max. RPM	Std. Pack	Item Number	
							Steel	Stainless
4"	.006	5/8"-11 UNC	1/2"	7/8"	14,000	5	—	00156
4"	.014	M14 x 2.0	1/2"	7/8"	14,000	5	13077 •	—
		3/8"-24 UNF					13078 •	—
		5/8"-11 UNC					13081	13085
4"	.014	5/8"-11 UNC	1/2"	7/8"	14,000	5	35416*	—

* Polyflex™ encapsulated - Burgundy elastomer. See Elastomer Color Code Chart on page 61 for more information.

• Non-stock product, contact Customer Service for lead times and minimum order quantities.

V **WOLVERINE® CRIMPED WIRE WHEEL** provides a flexible brushing action and cost-effective performance in general purpose cleaning and deburring applications.



Diameter	Wire Size	Arbor Hole	Face Width	Trim Length	Max. RPM	Standard Pack	Item Number
							Steel
4"	.014	5/8"-11 UNC	1/2"	3/4"	14,000	5	36207 •

• Non-stock product, contact Customer Service for lead times and minimum order quantities.

Crimped wire wheels with a permanently attached 1/4" stem or shank are primarily intended for use on high-speed die grinders. Although they can also be mounted onto a drill, the speed and power of that tool will limit the effectiveness of the brush. Featuring Weiler's solid ring construction, these radial wheels are available in heat-treated steel, Type 302 stainless steel, and brass wire.

APPLICATIONS

- Cleaning and finishing ID's and recessed areas
- Paint removal and surface cleaning
- Cleaning threads
- Light deburring

P **CONFLEX BRUSHES** **Narrow Face - 1/4" Stem** - Provide a very flexible brushing action.



Diameter	Wire Size	Face Width	Trim Length	Max. RPM	Standard Pack	Item Number	
						Steel	Stainless
2"	.006	3/8"	1/2"	20,000	10	17609	—
	.0118					17610 ■	17611 ■
2-1/2"	.006	3/8"	3/4"	20,000	10	17612	—
	.014					17614	—
3"	.008	1/2"	1"	20,000	10	17615 ■	—
	.0118					17616 ▲ ■	—
	.014					17617	17618 ■

■ Packaged product available. See pages 141-142 for details.

▲ Available in non-sparking brass wire, see page 102-103 for details.

P **POLYFLEX™ ENCAPSULATED CONFLEX BRUSHES - Burgundy Elastomer* - 1/4" Stem** - Feature an encapsulation that gradually wears away to expose a consistent short trim for higher aggression, controlled brushing action, and longer life.



Diameter	Wire Size	Face Width	Trim Length	Max. RPM	Standard Pack	Item Number
						Steel
2"	.0118	1/4"	1/2"	20,000	10	35305
3"	.008	1/4"	1"	20,000	10	35310
	.0118					35315

* See Elastomer Color Code Chart on page 61 for more information.



13085



36207



35416

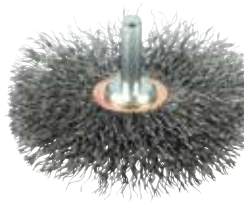

17616



35310

P

CONFLEX BRUSHES - Wide Face - 1/4" Stem - Provide a flexible brushing action and consistent performance for demanding light-duty cleaning and deburring applications; feature a wider face width to cover more area.



Diameter	Wire Size	Face Width	Trim Length	Max. RPM	Standard Pack	Item Number	
						Steel	Stainless
1-1/4"	.006	1/2"	3/8"	20,000	10	17600	—
	.008					17601	—
	.0118					17602	—
1-1/2"	.006	1/2"	1/2"	20,000	10	17603	—
	.008					17604	—
	.0118					17605	—
1-3/4"	.006	1/2"	5/8"	20,000	10	—	17608
	.008					—	17608
2"	.0118	3/4"	7/16"	20,000	10	17619	—
2-1/2"	.014	3/4"	11/16"	20,000	10	17620	—
3"	.008	1"	15/16"	20,000	10	17621	17637
	.0118					17622	—
	.014					17623	—



17603

P

CRIMPED WIRE RADIAL WHEELS 1/4" Stem - Feature side plates for a shorter trim length and more controlled brushing action in a stem-mounted crimped wire wheel.



Diameter	Wire Size	Face Width	Trim Length	Max. RPM	Standard Pack	Item Number	
						Steel	Stainless
1-1/2"	.006	1/4"	3/8"	20,000	10	17950	17971
	.008					17951	17972 •
	.0118					17952 •	17973
	.014					17953	—
						17954	—
2"	.006	3/8"	7/16"	20,000	10	17955	17974
	.008					17956	—
	.0118					17957	17975
	.014					17958 •	—
	.020					17959	17976 •
2-1/2"	.008	7/16"	9/16"	20,000	10	17961	—
	.0118					17962	17977 •
	.014					17963 •	—
	.020					17964	17978
3"	.008	1/2"	13/16"	20,000	10	17965	—
	.0118					17966	17979
	.014					17967	—
	.020					17968	17981
4"	.008	9/16"	1-5/16"	15,000	10	17969	17982
	.014					—	—



17971



17978

• Non-stock product, contact Customer Service for lead times and minimum order quantities.

V

WOLVERINE® CRIMPED WIRE RADIAL WHEELS 1/4" Stem - Designed to be a flexible and economic small diameter brushing tool for a broad range of general purpose applications.



Diameter	Wire Size	Face Width	Trim Length	Max. RPM	Standard Pack	Item Number
						Steel
1-1/2"	.0118	1/4"	3/8"	20,000	10	36208*
2"	.014	3/8"	7/16"	20,000	10	36209*
3"	.008	7/16"	13/16"	20,000	10	36259*
	.014					36211*

* Globally sourced products



36211

P

CONCAVE BRUSHES 1/4" Stem - Saucer-shaped radial wheels provide flexible brushing action for addressing corners and hard-to-reach areas.



Diameter	Wire Size	Face Width	Trim Length	Max. RPM	Standard Pack	Item Number	
						Steel	Stainless
1-1/2"	.006	1/4"	3/8"	20,000	10	17901	17930
	.008					17902	—
	.0118					17903	17931 •
2"	.008	3/8"	1/2"	20,000	10	17906	—
	.014					17907	17933
2-1/2"	.006	7/16"	5/8"	20,000	10	17909	—
	.014					17912	17935
3"	.006	1/2"	15/16"	20,000	10	17914	17936
	.008					17915	—
	.014					17917	17937
	.014					17922	—
4"	.008	9/16"	1-1/4"	20,000	10	17923	—
	.014					—	—



17907

• Non-stock product, contact Customer Service for lead times and minimum order quantities.

WHY WEILER

BONDED ABRASIVES

COATED ABRASIVES

NON-WOVEN ABRASIVES

POWER BRUSHES

NYLON BRUSHES

PACKAGED ITEMS

MAINTENANCE

NYLON AND TAMPICO WHEELS

MADE IN USA
WITH GLOBAL MATERIALS



Deburring a plastic part using a nylon brush.

NYLON WHEELS

Wheel brushes filled with non-metallic filaments are primarily intended for light-duty surface cleaning and scrubbing applications as well as scratch-free finishing and polishing. Synthetic filaments such as nylon are durable and provide a very flexible brushing action in applications requiring less aggression than a wire brush. The softer fill material allows them to be used on materials that a wire brush would scratch or gouge.

APPLICATIONS

- Wet or dry cleaning and scrubbing
- Removing burrs and die flash from plastic parts
- Sweeping loose chips and debris



P **NYLON WHEELS** feature a chemical-resistant synthetic fill material with excellent bend recovery for use in applications requiring a soft, durable fill material.



Diameter	Fill Diameter	Arbor Hole	Face Width	Trim Length	Max. RPM	Standard Pack	Item Number
2"	.010 .014	1/2"	3/8"	1/2"	20,000	10	17223 17233
2-1/2"	.022	5/8"	3/8"	11/16"	20,000	10	99346
3"	.010 .016	1/2"	3/8"	1"	20,000	10	29070 17263
6"	.016	2"	3/4"	1-1/2"	6,000	2	20490
8"	.020	2"	3/4"	2-1/2"	5,000	2	20510 •

For arbor hole reducing adapters, see Metal Adapter Table below and plastic adapters on page 79.

- Non-stock product, contact Customer Service for lead times and minimum order quantities.

TAMPICO WHEELS

MADE IN USA
WITH GLOBAL MATERIALS

Wheel brushes filled with non-metallic filaments are primarily intended for light-duty surface cleaning and scrubbing applications as well as scratch-free finishing and polishing. Natural vegetable fibers such as Tampico hold abrasive compounds well and can be used for deburring, edge blending, and polishing applications.

APPLICATIONS

- Wet or dry cleaning and scrubbing
- Buffing and polishing non-ferrous and precious metals
- Removing burrs and blending edges with abrasive compounds

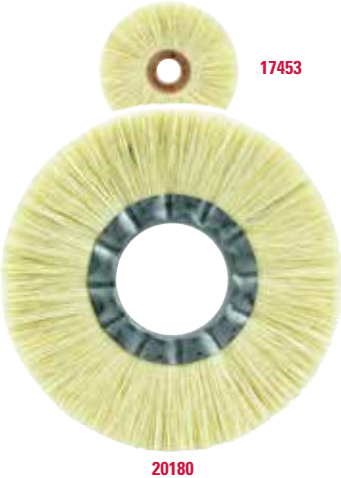

P **TAMPICO WHEELS** feature a durable vegetable fiber fill material that is chemical and heat resistant and also holds abrasive compounds well.



Diameter	Arbor Hole	Face Width	Trim Length	Max. RPM	Standard Pack	Item Number
2-1/2"	1/2"	1/2"	3/4"	20,000	10	17443
3"	1/2"	1/2"	1"	20,000	10	17453
6"	2"	5/8"	1-1/2"	6,000	10	20180
8"	2"	5/8"	2-1/2"	5,000	2	20190

For arbor hole reducing adapters, see Metal Adapter Table below and plastic adapters on page 79.

P **METAL ADAPTERS** for 6" & 8" Brushes. Used in pairs & priced per pair.



For Brush Arbor Hole Size	Adapted Arbor Hole Size	Standard Pack	Item Number
2"	1/2"	1 pair	03809
	5/8"	1 pair	03810
	3/4"	1 pair	03811
	7/8"	1 pair	03824
	1"	1 pair	03812
	1-1/4"	1 pair	03813
	1-1/2"	1 pair	03814

WIRE CUP BRUSHES

Cup brushes are for use on portable power tools for addressing larger surface areas more efficiently than a wheel brush. Cup brushes featuring a threaded nut are designed for smooth, efficient operation on angle grinders to make quick work of large jobs. Utility cup brushes featuring a permanently-attached 1/4" stem are more suitable for smaller jobs and are recommended for use on high-speed air tools for the most effective brushing action and longest life. Cup brushes are manufactured with individual knot hole and solid ring construction for high performance and long life.

APPLICATIONS

- Removal of slag from the edges of plasma or flame-cut plates
- Removing paint and coatings
- Cleaning rust, scale, and corrosion
- Deburring
- Weld prep and cleaning

CUP BRUSH SIZE SELECTION GUIDE

Brush Sizes	Angle Grinder Size
2-3/4" & 3"	4"
2-3/4", 3" & 3-1/2"	4-1/2"
2-3/4", 3" & 3-1/2"	5"
3-1/2" & 4"	6"
4", 5" & 6"	7"
4", 5" & 6"	9"

MADE IN
USA
WITH GLOBAL
MATERIALS

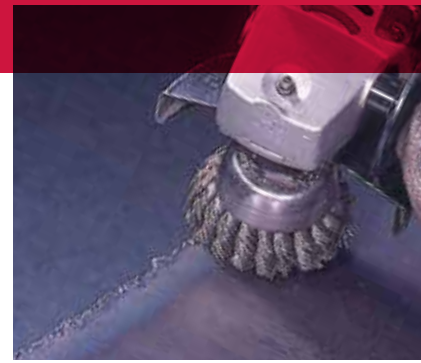

Removing slag from a flame-cut steel plate.

P

KNOT WIRE CUP BRUSHES - Single Row - Provide heavy-duty brushing action with some flexibility; ideal for demanding cleaning applications on relatively flat surfaces.



Diameter	Wire Size	Arbor Hole	Trim Length	Max. RPM	Standard Pack	Item Number		
						Steel	Stainless	
2-3/4"	.014	M10 x 1.25	1"	14,000	1	13015	—	
		M10 x 1.50				13016 •	—	
		M14 x 2.0				13020	—	
		3/8"-24 UNF				13021	—	
		5/8"-11 UNC				13025 ■	13009	
2-3/4"	.020	M10 x 1.25	1"	14,000	1	13281 ■	13253	
		M10 x 1.50				13282	13254 •	
		M14 x 2.0				13283	13255	
		3/8"-24 UNF				13284	13256	
		1/2"-13 UNC				13285	13257	
5/8"-11 UNC	13286 ▲ ■	13258 ■						
3-1/2"	.023	M10 x 1.25	7/8"	13,300	1	13150	—	
		M10 x 1.50				13151	—	
		M14 x 2.0				13152	13159 •	
		3/8"-24 UNF				13153	13160	
		1/2"-13 UNC				13155	—	
5/8"-11 UNC	13156 ■	13163 ■						
3-1/2"	.014	5/8"-11 UNC	1-1/4"	9,000	1	12736	—	
						.020	12746	—
4"	.014	5/8"-11 UNC	1-1/4"	10,200	1	12306 ▲	12406	
						.023	12316 ■	12416
						.035	12326	—
4"	.023	5/8"-11 UNC	1-1/4"	10,200	1	12206 ❖	—	
						.023	12826*	—
5"	.014	5/8"-11 UNC	1-3/8"	7,000	1	12256*	—	
						.023	12276 ■*	—
6"	.014	5/8"-11 UNC	1-3/8"	6,600	1	12356 ■	12456	
						.023	12376 ■	12476
						.035	12396	—
6"	.023	5/8"-11 UNC	1-3/8"	6,600	1	12816*	—	
6"	.014	5/8"-11 UNC	1-5/8"	6,000	1	12846	—	
						.023	12856	12886
						.035	12866	—

■ Packaged product available. See pages 141-142 for details.

BOLD BLACK ITEM numbers indicate color-coded brushes for easy identification.

▲ Available in non-sparking bronze wire, see page 102-103 for details.

• Non-stock product, contact Customer Service for lead times and minimum order quantities.

* With internal nut ❖ Cable Twist

P

KNOT WIRE CUP BRUSHES - Hurricane Twist - Very smooth brushing action and extended life with reduced cleaning action.



Diameter	Wire Size	Arbor Hole	Trim Length	Max. RPM	Standard Pack	Item Number	
						Steel	Stainless
2-3/4"	.014	M10 x 1.25	3/4"	14,000	1	13715 •	—
		M10 x 1.50				13716 •	—
		M14 x 2.0				13717 •	—
		5/8"-11 UNC				13718	—
2-3/4"	.020	M10 x 1.25	3/4"	14,000	1	13709 •	—
		M10 x 1.50				13710 •	—
		M14 x 2.0				13711 •	—
		5/8"-11 UNC				13712	—



13711

NOTE

If a different arbor hole is required (than listed in the tables) refer to Threaded Adapter Chart shown on Pg. 71.

• Non-stock product, contact Customer Service for lead times and minimum order quantities.

COATED ABRASIVES

NON-WOVEN ABRASIVES

POWER BRUSHES

NYLON BRUSHES

PACKAGED ITEMS

MAINTENANCE



V WOLVERINE® KNOT WIRE CUP BRUSHES - Single Row

Provide an aggressive brushing action for general-purpose surface cleaning applications.



Dia.	Wire Size	Arbor Hole	Trim Length	Max. RPM	Standard Pack	Item Number	
						Steel	Stainless
3"	.020	5/8"-11 UNC	1"	14,000	1	36238	36239
4"	.025	5/8"-11 UNC	1-1/4"	10,200	1	36244	-
6"	.025	5/8"-11 UNC	1-3/8"	6,600	1	36245	-



P KNOT WIRE CUP BRUSHES - Banded - Single Row - Feature a removable metal band around fill material to reduce the exposed trim length and limit brush flaring at operating speed to provide a very aggressive, controlled brushing action.



Diameter	Wire Size	Arbor Hole	Trim Length	Max. RPM	Standard Pack	Item Number	
						Steel	Stainless
2-3/4"	.014	5/8"-11 UNC	5/8"	12,500	1	13300	-
	.020					13301	13302
4"	.023	5/8"-11 UNC	7/8"	10,200	1	12301	-
5"	.023	5/8"-11 UNC	7/8"	6,600	1	12120	-



P KNOT WIRE CUP BRUSH - 1-1/2 Rows - Features an internal nut for use on dedicated equipment such as line traveling machines that clean and prep OD of pipe prior to coating.



Diameter	Wire Size	Arbor Hole	Trim Length	Max. RPM	Standard Pack	Item Number
						Steel
4"	.023	5/8"-11 UNC	1-1/4"	7,000	1	94012



P KNOT WIRE CUP BRUSHES - Double Row - Provide very aggressive brushing while still maintaining some flexibility; ideal for severe cleaning applications.



Diameter	Wire Size	Arbor Hole	Trim Length	Max. RPM	Standard Pack	Item Number	
						Steel	Stainless
4"	.014	5/8"-11 UNC	1-1/4"	9,000	1	12756	-
	.020					12766	12726
6"	.014	5/8"-11 UNC	1-3/8"	6,600	1	12536	-
	.023					12556	12636
	.035					12576	-
6"	.014	5/8"-11 UNC	1-1/2"	6,000	1	12906	-
	.023					12916	-
	.035					12926	-

• Non-stock product, contact Customer Service for lead times and minimum order quantities.



P KNOT WIRE CUP BRUSHES - Banded - Double Row - Feature a removable metal band around fill material to reduce the exposed trim length and limit brush flaring to provide an extremely aggressive, controlled brushing action for the most severe applications.



Diameter	Wire Size	Arbor Hole	Trim Length	Max. RPM	Standard Pack	Item Number
						Steel
4"	.020	5/8"-11 UNC	7/8"	9,000	1	12796
6"	.023	5/8"-11 UNC	7/8"	6,600	1	12676
	.035					12686



P POLYFLEX™ ENCAPSULATED CRIMPED WIRE CUP BRUSHES feature fill material that has been encapsulated in an elastomer that gradually wears away to keep only the wire tips exposed; ideal for applications on flat surfaces that require maximum aggression but no flexibility in the brushing action.



Diameter	Wire Size	Arbor Hole	Trim Length	Max. RPM	Standard Pack	Item Number
						Steel
Burgundy Elastomer* - Standard						
3-1/2"	.014	5/8"-11 UNC	7/8"	12,000	1	35406
4"	.020	5/8"-11 UNC	1-1/8"	9,000	1	35186
6"	.020	5/8"-11 UNC	1-1/4"	6,000	1	35006
Orange Elastomer* - Heavy-Duty						
6"	.020	5/8"-11 UNC	1-1/4"	6,000	1	35530 ▲
Black Elastomer* - Heavy-Duty - Heat-Resistant						
6"	.020	5/8"-11 UNC	1-1/4"	6,000	1	35760 ▲ •

* See Elastomer Color Code Chart on page 61 for more information.

• Non-stock product, contact Customer Service for lead times and minimum order quantities.

▲ With internal nut

P **CRIMPED WIRE CUP BRUSHES** provide very flexible brushing action and the most consistent performance for demanding light-duty cleaning applications; feature a threaded nut for use on angle grinders.



Diameter	Wire Size	Arbor Hole	Trim Length	Max. RPM	Standard Pack	Item Number	
						Steel	Stainless
3"	.014	M10 x 1.25 M10 x 1.50 M14 x 2.0 3/8"-24 UNF 1/2"-13 UNC 5/8"-11 UNC	1"	14,000	1	13240 ■▲	—
						13241	—
						13242	—
						13243	—
						13244	—
						13245 ■	—
3-1/2"	.014	M10 x 1.25 M10 x 1.50 M14 x 2.0 3/8"-24 UNF 1/2"-13 UNC 5/8"-11 UNC	7/8"	13,300	1	13175	13182
						13176 ●	—
						13177 ●	13184 ●
						13178	13185
						—	13187 ●
						13181 ■	13188
4"	.0118 .014 .020	5/8"-11 UNC	1-3/8"	10,200	1	14016	—
						14026 ■	—
						14036 ■▲	14126
5"	.014 .020	5/8"-11 UNC	1-1/4"	9,000	1	14206 ■▲	—
						14216	14256
6"	.014 .020	5/8"-11 UNC	1-1/4"	6,600	1	14066 ■*	—
						14076 ■▲*	14166*

* With internal nut ▲ Available in non-sparking brass & bronze wire, see page 102-103 for details. ■ Packaged product available. See pages 141-142 for details.
● Non-stock product, contact Customer Service for lead times and minimum order quantities.



Removing paint from a steel surface with a crimped wire cup brush.



13245



36237

V **WOLVERINE® CRIMPED WIRE CUP BRUSHES** provide flexible brushing action and cost-effective performance in general purpose cleaning applications.



Diameter	Wire Size	Arbor Hole	Trim Length	Max. RPM	Standard Pack	Item Number
						Steel
3"	.014	5/8"-11 UNC 1/2"-13 UNC	1"	14,000	1	36231
						36232 ●
4"	.020	5/8"-11 UNC	1-1/8"	9,000	1	36236
6"	.020	5/8"-11 UNC	1-1/2"	6,600	1	36237 *

* With internal nut ● Non-stock product, contact Customer Service for lead times and minimum order quantities.

NOTE

If a different arbor hole is required (than listed in the tables) refer to Threaded Adapter Chart shown on Pg. 71.

CUP BRUSHES WITH STEM

Designed primarily for use on high speed die grinders, cup brushes with permanently attached stems can also be used on drills.



P **UTILITY CRIMPED WIRE CUP BRUSHES** are smaller diameter cup brushes which provide flexible brushing action and consistent performance for more demanding light-duty cleaning applications; featuring a 1/4" stem for use on air tools.



Diameter	Wire Size	Trim Length	Overall Length	Max. RPM	Standard Pack	Item Number	
						Steel	Stainless
1-3/4"	.006 .0118	3/4"	2-5/16"	13,000	10	14300 ▲	14303 ●
						14301 ▲■	14304
2"	.008 .0118	5/8"	2-7/8"	13,000	10	14313 ●	14318 ●
						14306	14319 ●
2-1/2"	.008 .014	7/8"	3-1/8"	13,000	10	14315 ●	14320 ●
						14317	14321 ●
2-3/4"	.0118	7/8"	2-1/2"	6,000	1	14302 ▲■	—

■ Packaged product available. See pages 141-142 for details. ▲ Available in non-sparking brass wire, see page 102-103 for details.
● Non-stock product, contact Customer Service for lead times and minimum order quantities.



14301



36230

V **WOLVERINE UTILITY CRIMPED WIRE CUP BRUSH** is a flexible and economic small diameter brushing tool for a broad range of general purpose applications using air tools or drills. 1/4" Stem.



Diameter	Wire Size	Trim Length	Overall Length	Max. RPM	Standard Pack	Item Number
3"	.014	1"	3-1/4"	13,000	1	36230

COATED ABRASIVES

NON-WOVEN ABRASIVES

POWER BRUSHES

NYLON BRUSHES

PACKAGED ITEMS

MAINTENANCE

STEM-MOUNTED END BRUSHES



Cleaning hard-to-reach fillet welds on a gusseted base plate.

Wire end brushes are for use on high-speed portable power tools for addressing smaller surfaces and recessed areas. End brushes feature an integral 1/4" steel stem for safe operation at high speed and quick mounting into the collet or chuck of either electric or pneumatic die grinders.

End brushes are available in a variety of knot wire and crimped wire configurations for use in a broad range of applications, and they are manufactured with the highest quality construction for smooth, efficient performance and long life. Weiler's end brushes are available in heat-treated steel, Type 302 stainless steel, and bronze or brass wire.

APPLICATIONS

- Cleaning ID's, internal passages and recessed areas
- Deburring internal edges and crosshole intersections
- Removal of die flash and excess molded material
- Spot facing

MADE IN
USA
WITH GLOBAL
MATERIALS



P **KNOT WIRE END BRUSHES** feature a hollow end and heavy-duty brushing action with some flexibility; ideal for more demanding cleaning applications in recessed areas.

Diameter	Wire Size	Trim Length	Overall Length	Max. RPM	Standard Pack	Item Number	
						Steel	Stainless
1/2"	.006	1-1/8"	2-7/8"	20,000	10	-	10215 *
	.0104					10208	10216
	.014					10217	10218
3/4"	.006	1-1/8"	2-7/8"	20,000	10	-	10220 *
	.0104					10210	10211
	.014	7/8"	2-5/8"	25,000	10025 ■	10029 ■	
	.020				10026 ■	10030	
1-1/8"	.006	1-1/8"	2-9/16"	20,000	10	10141 ■ *	10142 • *
	.0104		2-7/8"			10212	10213
	.0118	7/8"	2-5/8"	22,000	10187	-	
	.014				10027 ■	10031 ■	
	.020				10028 ▲ ■	10032	

• Coated cup ■ Packaged product available. See pages 141-142 for details.

▲ Available in non-sparking bronze wire, see page 102-103 for details.

* Globally sourced product

BOLD BLACK ITEM numbers indicate color-coded brushes for easy identification.

P **KNOT WIRE END BRUSHES - Nickel-plated Cup compliant with DOD MIL STD 2041D(SH)**

Feature a hollow end and heavy-duty brushing action with some flexibility; ideal for more demanding cleaning applications in recessed areas.



Diameter	Wire Size	Trim Length	Overall Length	Max. RPM	Standard Pack	Item Number	
						Steel	Stainless
3/4"	.014	7/8"	2-5/8"	22,000	10	10387 •	10388 •
	.020					10392	10393 •
1-1/8"	.014	7/8"	2-5/8"	22,000	10	10387 •	10388 •
	.020					10392	10393 •

• Non-stock product, contact Customer Service for lead times and minimum order quantities.

V **WOLVERINE® KNOT WIRE END BRUSHES** feature similar hollow-end construction and heavy-duty brushing action, but they have been engineered to provide cost-effective use for less demanding applications.



Diameter	Wire Size	Trim Length	Overall Length	Max. RPM	Standard Pack	Item Number	
						Steel	Stainless
3/4"	.014	7/8"	2-5/8"	22,000	10	36286	36287 •
	.020		2-9/16"			36250	-
	1"		2-5/8"			36288	36289
1"	.014	7/8"	2-9/16"	22,000	10	36251	-
	.020		2-9/16"			36251	-

• Non-stock product, contact Customer Service for lead times and minimum order quantities.

P **KNOT WIRE END BRUSHES - Banded** - Feature a pair of bands around the fill to reduce the exposed trim length and limit brush flaring to provide a very aggressive, controlled brushing action.



Diameter	Wire Size	Trim* Length	Overall Length	Max. RPM	Standard Pack	Item Number	
						Steel	Stainless
1-1/8"	.014	3/8"	2-5/8"	18,000	10	11140	11141
	.020					11140	11141

* Trim length from bands

P **CRIMPED WIRE END BRUSHES** feature a solid end construction and very flexible brushing action ideal for more demanding light-duty cleaning applications in corners and hard-to-reach areas.



Diameter	Wire Size	Trim Length	Overall Length	Max. RPM	Standard Pack	Item Number	
						Steel	Stainless
3/8"	.0118	7/8"	2-1/2"	20,000	10	10188	—
1/2"	.006	7/8"	2-9/16"	25,000	10	10001 ▲ ■	10013 ■
	.0104					10002	10014 ■
	.014					10003	10015 ■
	.020					10004	10016 ■
3/4"	.006	7/8"	2-9/16"	22,000	10	10005 ■	10017 ■
	.0104					10006	10018
	.014					10007	10019
	.020					10008 ■	10020
1"	.006	1"	2-3/16"	22,000	10	10009 ▲ ■	10021 ■
	.0104					10010 ■	10022 ■
	.014	1-1/8"	2-15/16"	10011 ▲	10023		
	.020			10012 ■	10024		

■ Packaged product available. See pages 141-142 for details.

▲ Available in non-sparking brass wire, see page 102-103 for details.
BOLD BLACK ITEM numbers indicate color-coded brushes for easy identification.



Cleaning the exhaust port of a gasoline engine.



10013



10010



11013

P **CRIMPED WIRE END BRUSHES - Coated Cup** - Feature a solid end construction and very flexible brushing action ideal for more demanding light-duty cleaning applications in corners and hard-to-reach areas. The plastic sleeve covering the cup protects the work surface from being scratched or marked.



Diameter	Wire Size	Trim Length	Overall Length	Max. RPM	Standard Pack	Item Number	
						Steel	Stainless
1/2"	.006	7/8"	2-9/16"	25,000	10	11000	11010
	.0104					11001	11011
3/4"	.006	7/8"	2-9/16"	22,000	10	11003	11013
	.0104					11004	11014
1"	.006	7/8"	2-3/4"	22,000	10	11006	11016
	.0104					1" 11007	11017

P **CRIMPED WIRE END BRUSHES - Nickel-plated Cup** - Feature a solid end construction and very flexible brushing action ideal for more demanding light-duty cleaning applications in corners and hard-to-reach areas. **The nickel-plated cup is compliant with DOD MIL STD 2041D(SH).**



Diameter	Wire Size	Trim Length	Overall Length	Max. RPM	Standard Pack	Item Number	
						Steel	Stainless
1/2"	.006	7/8"	2-9/16"	25,000	10	10370 ●	10371 ●
	.0104					10372 ●	10373 ●
	.014					10374 ●	10375 ●
	.020					10376 ●	10377 ●
3/4"	.006	7/8"	2-9/16"	22,000	10	10378 ●	10379 ●
	.0104					10380 ●	10381 ●
	.014					10374 ●	10375 ●
	.020					10376 ●	10377 ●
1"	.006	1"	2-7/8"	22,000	10	10378	10379
	.0104					10380 ●	10381 ●
	.014	1-1/8"	2-15/16"	10378	10379		
	.020			10380 ●	10381 ●		

● Non-stock product, contact Customer Service for lead times and minimum order quantities.



10374

V **WOLVERINE® CRIMPED WIRE END BRUSHES** feature similar solid end construction and flexible brushing action, but they have been engineered to provide cost-effective use for less demanding applications.



Diameter	Wire Size	Trim Length	Overall Length	Max. RPM	Standard Pack	Item Number	
						Steel	Stainless
1/2"	.0104	7/8"	2-9/16"	25,000	10	36282	—
3/4"	.006	7/8"	2-9/16"	22,000	10	—	36283
	.0104					36247	—
	.014					36246	—
1"	.006	7/8"	2-3/4"	22,000	10	36284	36285
	.0104					36249	—
	.014					36248	—
	.020					36248	—



36247

COATED ABRASIVES

NON-WOVEN ABRASIVES

POWER BRUSHES

NYLON BRUSHES

PACKAGED ITEMS

MAINTENANCE



11112

P **CRIMPED WIRE END BRUSHES - Banded** - Feature bands around the fill to reduce the exposed trim length and limit brush flaring at operating speed to provide an aggressive, controlled brushing action.



Diameter	Wire Size	Trim Length*	Overall Length	Max. RPM	Standard Pack	Item Number	
						Steel	Stainless
1/2"	.006	9/16"	2-9/16"	20,000	10	11100	11110
	.0104			25,000		11101	-
3/4"	.006	7/16"	2-11/16"	20,000	10	11102	11112
	.0104	3/8"				11103	11113
1"	.006	3/8"	2-5/8"	13,000	10	-	11114
	.0104					11105	11115

* Trim length from bands



10310

P ***CONTROLLED FLARE END BRUSHES** feature uniquely trimmed crimped wire fill for more effective brushing action and greatly enhanced durability when cleaning corners and fillet welds.



Diameter	Wire Size	Trim Length	Overall Length	Max. RPM	Standard Pack	Item Number	
						Steel	Stainless
1/2"	.0104	7/8"	2-9/16"	25,000	10	10301	10313
	.014					10302	10314
	.020					10303	10315
3/4"	.0104	7/8"	2-9/16"	22,000	10	10305	10317
	.014					10306	-
	.020					10307	10319
1"	.0104	1"	2-7/8"	22,000	10	10309	10321
	.014					10310	10322
1"	.020	1-1/8"	2-15/16"	22,000	10	10311	10323

*Patent #8,186,000 B2

The unique trim of a controlled flare end brush is designed specifically to address hard-to-reach areas, reducing filament fatigue and breakage typically associated with a standard end brush when cleaning corners and fillet welds.



Standard Crimped Wire End Brush



Controlled Flare End Brush



10059

P **CRIMPED WIRE PILOT BONDING BRUSHES - Banded - Solid end.** Originally designed to clean around rivet holes in aluminum aircraft panels but may be used in other similar applications.



Diameter	Wire Size	Trim Length	Overall Length	Pilot Diameter	Max. RPM	Standard Pack	Item Number	
							Steel	Stainless
1/2"	.005	3/8"	2-1/4"	3/32"	20,000	10	10056*	
				1/8"			10057*	
				5/32"			10058*	
				3/16"			10059*	

* Globally sourced product



35350

P **POLYFLEX® ENCAPSULATED CRIMPED WIRE END BRUSHES**
Burgundy Elastomer* - Feature fill material that has been encapsulated in an elastomer that gradually wears away to keep only the wire tips exposed; ideal for applications such as spot facing that may require maximum aggression and no flaring.



Diameter	Wire Size	Trim Length	Overall Length	Max. RPM	Standard Pack	Item Number	
						Steel	Stainless
Burgundy Elastomer* - Standard							
1/2"	.0104	7/8"	2-9/16"	18,000	10	35340	35500
3/4"	.0104	7/8"	2-9/16"	16,000	10	35345	35505
1"	.0104	7/8"	2-3/4"	14,000	10	35350	-
Orange Elastomer* - Heavy-Duty							
1/2"	.0104	7/8"	2-9/16"	18,000	10	35535	-
3/4"	.0104	7/8"	2-9/16"	16,000	10	35540	-
1"	.0104	7/8"	2-3/4"	14,000	10	35545	-

* See Elastomer Color Code Chart on page 61 for more information.

• Non-stock product, contact Customer Service for lead times and minimum order quantities.

P **CIRCULAR FLARED END BRUSHES** feature crimped wire fill that has been “pre-flared” to match the working angle of the brush at operating speed; suited for addressing broad and slightly contoured surfaces.

Diameter	Wire Size	Max. RPM	Standard Pack	Item Number	
				Steel	Stainless
1"	.006	25,000	1	10033	10042
	.008			10034	10043
	.020			10099	—
1-1/4"	.006	20,000	1	10076	—
	.008			10035	—
	.020			—	—
1-1/2"	.006	20,000	1	10044	10045
	.008			10037	10046
	.020			10038	10047
2"	.014	25,000	2	11142	—
2-3/4"	.008	16,000	2	10039	10048
	.020			10040	—
	.020			—	—
3"	.006	16,000	2	10150	10151
	.008			10041 ■	10050
	.014			10134	—
	.020			10073	10074
4"	.008	15,000	1	—	96705

■ Packaged product available. See pages 141-142 for details.



P **POLYFLEX® ENCAPSULATED CIRCULAR FLARED END BRUSHES**
Black Elastomer* - Crimped wire fill that has been encapsulated in a heavy-duty elastomer that gradually wears away to keep only the wire tips exposed. Their saucer-shape, narrow face, and aggressive brushing action make them suitable for addressing edges, corners, and confined areas.

O.D. Diameter	Wire Size	Cup Size	Overall Length	Max. RPM	Standard Pack	Item Number	
						Steel	Stainless
1-3/4"	.006	3/4"	2"	25,000	2	35222	—
	.0104					35223	35226
	.020					35224	—
2"	.0104	3/4"	1-1/8"	20,000	2	35233	—
	.020					35234	—
	.020					—	—

* See Elastomer Color Code Chart on page 61 for more information.



P **PENCIL END BRUSHES** contain straight wire fill material retained in a small diameter steel tube. They provide a light-duty brushing action suitable for very small recessed areas.

Tube Diameter	Wire Size	Trim Length	Overall Length	Max. RPM	Standard Pack	Item Number	
						Steel	Stainless
1/4"	.0104	3/4"	3-3/4"	8,000	10	99825	99823



When brushing a recessed area or the inside diameter of a tube, use an End Brush in the following manner: Insert the brush, start the brush rotating. Turn off the power before removing the brush. This will prevent the brush from flaring out and enable it to fit into the recessed area again.



1. Insert Brush 2. Apply Power 3. Shut-Off Power 4. Remove Brush



MOUNT END BRUSHES SAFELY

When mounting end brushes, the amount of overhang from the tool should be minimized by clamping on as much of the straight portion of the stem as possible. However, the collet or chuck should NOT clamp on the radius at the base of the stem to insure a secure hold before use. See photo above for the correct brush orientation.

WHY WEILER BONDED ABRASIVES COATED ABRASIVES NON-WOVEN ABRASIVES POWER BRUSHES NYLON BRUSHES PACKAGED ITEMS MAINTENANCE

BORE-RX™ CROSSHOLE DEBURRING BRUSHES



Deburring intersecting oil passages in an engine block.

MADE IN USA
WITH GLOBAL MATERIALS

Designed for automated use in CNC machining centers and dedicated equipment. They are densely filled for high aggression and long tool life and feature a 3/8" diameter steel stem with a flat for use in a collet or end-mill holder.

Bore-Rx brushes are ideal tools for removing burrs from internal edges. Since they can eliminate manual deburring operations, these internal brushing tools help to improve part-to-part consistency and reduce direct labor costs. Bore-Rx brushes are available in sizes ranging from 3/4" to 4" in diameter, and they are designed to be interpolated within bore sizes that are larger than the brush diameter.

Operating Parameters For Wire Bore-Rx Brushes

Brush Diameter	Recommended RPM	Recommended Feed Rate
5/8" - 7/8"	8,000	20"/min
1" - 1-1/2"	8,000	20"/min
2" - 2-1/2"	6,000	20"/min
3" - 4"	3,000	20"/min

Tool Paths for Crosshole Deburring

An effective tool path for most crosshole deburring jobs is circular interpolation using the following guidelines to determine diameter of interpolation. The interpolation should be performed at a depth where the center of the brush face is at the center of the intersecting hole.

$$\text{Diameter of Interpolation} = \text{Hole Diameter} - \text{Brush Diameter}$$



17205



BORE-RX™ BRUSHING TOOLS - Crimped wire fill - Feature dense wire fill for aggressive deburring action on ductile metals and other hard-to-deburr materials.

Diameter	Wire Size	Face Width	Overall Length	Max. RPM	Standard Pack	Item Number
						Steel*
3/4"	.005	3/8"	4-3/8"	8,000	1	17202
		3/4"	4-3/4"			17203
7/8"	.006	3/4"	4-3/4"	8,000	1	17205
1"	.006	3/4"	5"	8,000	1	17207 •
1-1/4"	.006	3/4"	4-3/4"	8,000	1	17209 •
1-1/2"	.006	1"	5"	8,000	1	17211 •
2"	.006	1"	4-1/4"	6,000	1	17214 •
2-1/2"	.008	1"	4-3/4"	6,000	1	17216 •
3"	.008	1"	5-1/4"	6,000	1	17218 •
4"	.0118	1"	6-1/4"	6,000	1	17219

* Stainless Steel fill is available by special order.

• Non-stock product, contact Customer Service for lead times and minimum order quantities.

Note: All Bore-Rx brush stems have a 2" long flat for use in end mill holders. Alternatively, they can be mounted in 3/8" collets. Bore-Rx extension holder is available. To discuss specific requirements with a specialist call: 800-835.9999.



17218

CUSTOMIZABLE CROSSHOLE DEBURRING SOLUTIONS

Replacement Bore-Rx Brush Heads and Reusable Bore-Rx Arbors

In high production applications, reusable arbors reduce manufacturing costs by allowing the use of inexpensive brush head replacements. Brush heads are made-to-order in diameters ranging from 3/4" to 1-1/2" with face widths of 1/4" to 1". They are available on 3/16" and 1/4" pins. The pin diameter is based on the application and determines brush density. To discuss specific requirements with a specialist call: 800-835.9999.



Replacement Head



Reusable Extension 03991 •



Reusable Arbor 03993 •

POWER AND HAND TUBE BRUSHES

Weiler offers a comprehensive line of power and hand tube brushes for internal cleaning and deburring applications in tubing, pipe, drilled-and-tapped holes, and machined bores and passages. Due to their twisted-in-wire construction, the use of power tube brushes is limited to low-speed power tools such as drills and drill presses and to CNC and manual machine tools in which the RPM can be precisely programmed or set. In addition, they should not be used in reverse rotation to prevent unraveling of the stem wire. Available in a wide variety of brush configurations and fill materials, Weiler can supply a tube brush for any application. If you do not see what you need in this catalog, see the Special Tube Brush Design Specification Sheet on page 85, or call 800-835.9999 for assistance.

APPLICATIONS

- Deburring and cleaning drilled-and-tapped holes and other internal threads
- Cleaning and finishing the ID of tubing and pipe
- Crosshole deburring
- Removing burrs and chips from internal keyways, slots, and grooves
- Removing paint, coatings, and build-up other foreign material from the surfaces of bores and passages

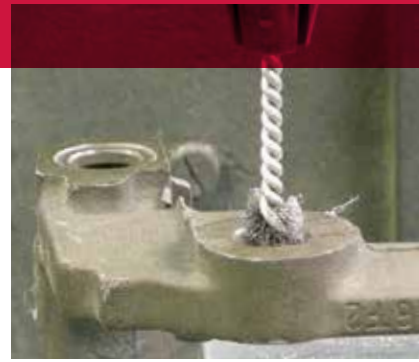

Removing zinc coating from holes in a brake bracket.

MADE IN
USA
WITH GLOBAL
MATERIALS

POWER AND HAND TUBE BRUSH SELECTION TIPS

- A flat burr style tube brush is most effectively used with a holder on blind, threaded holes.
- A round tube brush is most effectively used fully chucked on smooth or threaded blind holes.
- A single stem, single spiral tube brush is most effectively used for manual or hand cleaning applications.
- A double stem, double spiral tube brush is most effectively used with power tools for heavy-duty cleaning and deburring.
- A polyflex encapsulated double stem, double spiral tube brush is most effectively used on power tools for very aggressive cleaning and deburring applications.



P

DOUBLE STEM, DOUBLE SPIRAL feature four stem wires and a double spiral of straight wire fill material to provide aggressive cleaning and deburring action.



Diameter	Wire Size	Brush Part	Stem Diameter	Overall Length	Max. RPM	Standard Pack	Item Number	
							Steel	Stainless
3/8"	.003	1-1/2"	1/8"	4"	2,000	10	21342	—
	.006	2-1/8"		6"			21232	—
1/2"	.004	2"	5/32"	5"	2,000	10	21106	21116
	.006						21107 ▲ ■	21117
	.0104						21252	—
5/8"	.005	2"	7/32"	5"	2,000	10	21108 ■	21118
	.008						21109 ▲	21119
	.0104						21184	—
3/4"	.006	2-1/2"	1/4"	5-1/2"	2,000	10	21110 ▲ ■	21120
	.008						21247	—
	.0104						21111	21121
7/8"	.006	2-1/2"	1/4"	5-1/2"	2,000	10	21112	21122
	.0104						21113	21123
1"	.006	2-1/2"	1/4"	5-1/2"	2,000	10	21114 ▲ ■	21124
	.0104						21115	21125
1-1/4"	.006	2-1/2"	1/4"	5-1/2"	2,000	10	21164	21245
	.0104						21167 ★	21236
1-1/2"	.014	2-1/2"	1/4"	5-1/2"	2,000	10	—	21413

■ Packaged product available. See pages 141-142 for details. ★ 5" Overall length ▲ Available in non-sparking brass wire, see page 102-103 for details.



COATED ABRASIVES

NON-WOVEN ABRASIVES

POWER BRUSHES

NYLON BRUSHES

PACKAGED ITEMS

MAINTENANCE

P POLYFLEX™ ENCAPSULATED DOUBLE STEM, DOUBLE SPIRAL

Burgundy Elastomer® - Encapsulated with an elastomer that leaves only the sharp wire tips exposed for maximum aggression and a very rigid brushing action.



Diameter	Wire Size	Brush Part	Stem Diameter	Overall Length	Max. RPM	Standard Pack	Item Number	
							Steel	
1/2"	.006	2"	5/32"	5"	2,000	10		35821
5/8"	.0104	2"	7/32"	5"	2,000	10		35822
3/4"	.0104	2-1/2"	1/4"	5-1/2"	2,000	10		35823
1"	.0104	2-1/2"	1/4"	5-1/2"	2,000	10		35825 •

* See Elastomer Color Code Chart on page 61 for more information.

• Non-stock product, contact Customer Service for lead times and minimum order quantities.

P ROUND - Feature a single continuous length of stainless steel stem wire and a single spiral of crimped wire fill for a more flexible brushing action; for use on smooth or threaded blind holes.



Diameter	Wire Size	Brush Part	Stem Diameter	Overall Length	Max. RPM	Standard Pack	Item Number	
							Steel	Stainless
1/4"	.004	1"	1/8"	3-1/2"	2,000	10	21072 ▲	21081 ■
5/16"	.005	1"	1/8"	3-1/2"	2,000	10	21175	—
3/8"	.004	1"	1/8"	3-1/2"	2,000	10	21073 ■	21082
	.006						—	
	.008						21264	21240
7/16"	.005	1"	1/8"	3-1/2"	2,000	10	21142	21181
1/2"	.005	1"	3/16"	3-1/2"	2,000	10	21074 ▲ ■	21083
9/16"	.005	1"	3/16"	3-1/2"	2,000	10	21143	—
	.0104						—	21404
5/8"	.005	1"	3/16"	3-1/2"	2,000	10	21075 ■	21084
	.008						21265	—
11/16"	.005	1"	3/16"	3-1/2"	2,000	10	21144	—
3/4"	.006	1"	7/32"	3-1/2"	2,000	10	21076	21085
	.008						21266	—
13/16"	.005	1"	7/32"	3-1/2"	2,000	10	21146	—
7/8"	.006	1"	7/32"	3-1/2"	2,000	10	21077 ■	21086
	.008						21267	—
15/16"	.005	1"	7/32"	3-1/2"	2,000	10	21148 •	—
1"	.005	1"	1/4"	3-1/2"	2,000	10	21149	21340
	.008						21078 ■	21087
1-1/8"	.005	1"	1/4"	3-1/2"	2,000	10	21150	—
	.008						21079	21088
1-1/4"	.008	1"	1/4"	3-1/2"	2,000	10	21080	21089
1-1/2"	.008	1"	1/4"	3-1/2"	2,000	10	21203 ▲	—
	.0104						21269	—
2-1/4"	.008	1"	1/4"	3-1/2"	2,000	10	21322	—

■ Packaged product available. See pages 141-142 for details. ▲ Available in non-sparking brass wire, see page 102-103 for details.

• Non-stock product, contact Customer Service for lead times and minimum order quantities.

Correct Mounting in Chuck



Incorrect Mounting in Chuck



TUBE BRUSH OPERATING RECOMMENDATIONS

The stems in power tube brushes are not as strong as the stems in most other brushes. Therefore, it is very important to avoid any load conditions and brush speeds that can cause excessive stem deflections and destructive bending.

A suggested guideline to avoid this unsafe condition is minimizing the overhang of the stem to under an inch, and running the brush at speeds below 2,000 RPM.

Increasing overhang could decrease the safe speed at which the brush can operate. To reach into deeper holes, use drill extension rods instead of increasing stem overhang.

BEFORE STARTING THE BRUSH:

- Secure brush in chuck.
- Ensure clockwise brush rotation (running the brush counter-clockwise could cause the brush to fall apart.)
- Clamp work securely.
- Position all guards in place.
- Align brush with the work so the brush rotates on its true centerline to prevent any stem deflections.
- Guide the brush into the hole before starting the brush rotation.
- Always wear eye protection.

P

BURRITE - Feature a single continuous length of stainless steel stem wire and filled with a tuft of crimped wire to provide an aggressive flat side action; ideal for cleaning and deburring internal threads.



Deburring the threads of a tapped hole using a burrite brush in a holder.

Diameter	Wire Size	Brush Part	Stem Diameter	Overall Length	Max. RPM	Standard Pack	Item Number	
							Steel	Stainless
1/4"	.003	9/16"	3/32"	2-1/8"	2,000	10	21000	-
	.005						21001	21050
5/16"	.003	9/16"	3/32"	2-1/8"	2,000	10	21004	-
	.005						21005	-
3/8"	.003	9/16"	3/32"	2-1/8"	2,000	10	21008	-
	.005						21009	21051
	.005						21023	-
7/16"	.003	9/16"	3/32"	2-1/8"	2,000	10	21014	-
	.005						21015	-
1/2"	.003	9/16"	3/32"	2-1/8"	2,000	10	21020	-
	.005						21021	21053
	.005						21025	-
9/16"	.003	5/8"	1/8"	2-1/4"	2,000	10	21027	-
	.005						21028	-
5/8"	.003	5/8"	1/8"	2-1/4"	2,000	10	21030	-
	.005						21031	21055
3/4"	.005	5/8"	1/8"	2-1/4"	2,000	10	21034	21056
	.008						21035	-
7/8"	.005	5/8"	1/8"	2-1/4"	2,000	10	21036	21057
	.005						21040	21058
1"	.005	5/8"	1/8"	2-1/4"	2,000	10	21041	-
	.008						21041	-
1-1/8"	.005	5/8"	1/8"	2-1/4"	2,000	10	21044	-

• Non-stock product, contact Customer Service for lead times and minimum order quantities.



21014



21040

P

BURRITE HOLDERS - Feature a 1/4" stem for convenient mounting into the chuck of a drill or the collet of a machine tool and allow the brush to be used in either direction of rotation. They allow the brush to be used in a standard tapping cycle for deburring threaded holes in CNC machining centers.



For Brush Stem Dia.	Holder Diameter	Overall Length	Standard Pack	Item Number
3/32"	1/4"	3-1/8"	5	95202
1/8"	3/8"	3-3/8"	5	95203



95203

P

SINGLE STEM, SINGLE SPIRAL - Feature a single continuous length of galvanized steel stem wire with a formed eye loop for convenient hand use. The single spiral of straight wire fill allows for easy manual insertion into the ID.

Diameter	Wire Size	Brush Part	Stem Diameter	Overall Length	Standard Pack	Item Number	
						Steel	Stainless
1/8"	.003	1"	3/32"	6"	10	21246	21249
3/16"	.003	1-1/2"	3/32"	7"	10	21090 ▲	21098
	.005					21091	21099
1/4"	.003	1-1/2"	3/32"	7"	10	21092 ▲	21100
	.005					21093 ▲	21101
	.006					21161	-
3/8"	.004	2"	1/8"	8"	10	21094 ▲	21414
	.006					21095	21103
1/2"	.004	2"	1/8"	8"	10	21096 ▲	21104
	.006					21097	21105
	.008					21162	-
9/16"	.005	2-1/2"	5/32"	9"	10	21233	-

▲ Available in non-sparking brass wire, see page 102-103 for details.



21096

COATED ABRASIVES
 NON-WOVEN ABRASIVES
 POWER BRUSHES
 NYLON BRUSHES
 PACKAGED ITEMS
 MAINTENANCE

P NYLON HAND TUBE BRUSHES feature a single continuous length of galvanized steel stem wire with a formed eye loop for convenient hand use. The single spiral of straight nylon fill allows for easy manual insertion and scratch-free cleaning of the ID.



Diameter	Fill Diameter	Brush Part	Stem Diameter	Overall Length	Standard Pack	Item Number
						Nylon
1/4"	.005	2"	3/32"	6-1/4"	36	44110*
3/8"	.005	2"	3/32"	6-1/4"	36	44213*
1/2"	.010	3"	1/8"	8-1/2"	36	44111*
3/4"	.012	3"	1/8"	8-1/2"	36	44112*
1"	.014	4"	5/32"	12-1/4"	36	44113*
1-1/4"	.014	4"	5/32"	13"	36	44114*
2"	.014	5"	3/16"	16-3/4"	36	44115*

* Globally sourced product

P PERCOLATOR BRUSH features single stem, single spiral construction with an eye loop and straight white nylon fill. Intended for cleaning the internal passages in coffee percolators, this brush can be also be used in other similar manual cleaning applications.



Diameter	Fill Diameter	Brush Part	Stem Diameter	Overall Length	Standard Pack	Item Number
						Nylon
7/16"	.010	3-1/2"	5/32"	11-1/2"	10	44316

P VALVE GUIDE BRUSHES are made with single stem, single spiral construction and have a permanently-attached 1/4" diameter long steel handle for convenient hand use or for mounting into a chuck. Intended for removing heavy deposits from valve guides in gas and diesel engines, these brushes can also be used in a range of other similar applications.



Diameter	Fill Diameter / Material	Brush Part	Overall Length	Max. RPM	Standard Pack	Item Number
1/4"	.0104 Steel	2"	10"	2,000	10	95563 •
5/16"						95027
11/32"						95566 •
3/8"						95028
7/16"						95665 •
1/2"						95029
11/32"	.008 Nylon	2-1/2"	10"	2,000	10	95660 •
3/8"	.012 Nylon					95567 •

• Non-stock product, contact Customer Service for lead times and minimum order quantities.

P GUN CLEANING BRUSHES - Rifle Brushes - Constructed using a continuous piece of stem wire and fine bronze wire fill for a scratch-free cleaning action in gun barrels, these flexible tube brushes are designed to be attached to extension rods using the 8-32 male coupling.



Caliber	Brush Part	Overall Length	Coupling Size	Standard Pack	Item Number
					Bronze
22	2-1/4"	3-1/4"	8-32	10	95301
30	2-1/4"	3-1/4"	8-32	10	99786 •
35	2-1/4"	3-1/4"	8-32	10	99788 •
45	2-1/4"	3-1/4"	8-32	10	99791 •

• Non-stock product, contact Customer Service for lead times and minimum order quantities.

P GUN CLEANING BRUSHES - Shotgun Brushes -Constructed using a continuous piece of stem wire and fine bronze wire fill for a scratch-free cleaning action in gun barrels, these flexible tube brushes are designed to be attached to extension rods using the 5/16"-27 male coupling.



Gauge	Brush Part	Overall Length	Coupling Size	Standard Pack	Item Number
					Bronze
12	1-5/8"	2-7/8"	5/16-27	10	99714 •
16	1-5/8"	2-7/8"	5/16-27	10	99694 •
20	1-5/8"	2-7/8"	5/16-27	10	95084
410	1-5/8"	2-7/8"	5/16-27	10	95129 •

• Non-stock product, contact Customer Service for lead times and minimum order quantities.

SPECIAL TUBE BRUSH SPECIFICATION SHEET:

(Use the illustration on this page as a guide)

- Brush diameter _____
- Length of brush part _____
- Overall brush length _____
- Special stem diameter (if required) _____
- Stem material:
 Galvanized Steel Stainless Other
- Application _____
- Brush fill material:
 Steel wire Stainless wire
 Nylon Abrasive Filament (Nylox®)
 Brass wire Other _____
- Fill material diameter _____
- Special tip style (if required) _____
- Single stem Double stem
- Order Quantity _____

* Special tube brushes are not returnable, as they are manufactured to order.

Name: _____
 Company Name: _____
 Address: _____
 Phone: (____) _____
 Fax: (____) _____
 E-mail: _____

End-User Name: _____
 City: _____
 State: _____ Zip: _____

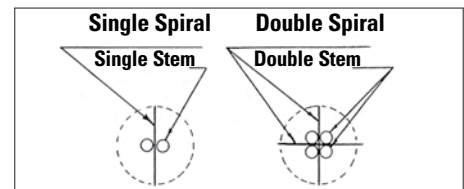
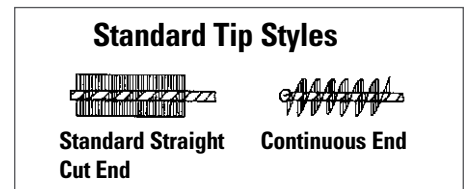
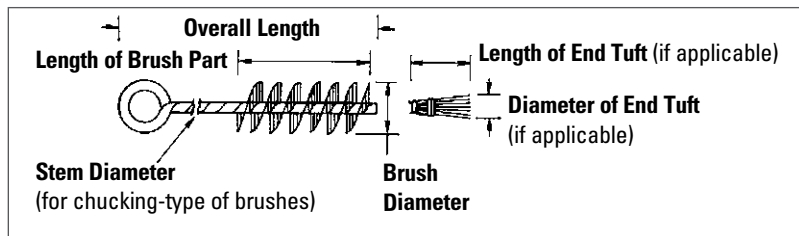

FOR ADDITIONAL INFORMATION CALL:

To discuss specific requirements with a specialist call: 800-835.9999

FAX SPECIFICATION SHEET TO:

Customer Service
 Fax: 800-635-3615

SUBMIT FORM ONLINE:

weilerabrasives.com/tube-brushes



CROSSFLEX™

Cross hole deburring and honing solutions for off-hand and automated applications.

See pages 96-99

WHY WEILER BONDED ABRASIVES COATED ABRASIVES NON-WOVEN ABRASIVES POWER BRUSHES NYLOX BRUSHES PACKAGED ITEMS MAINTENANCE

CROSSFLEX™ HONING BRUSHES

CrossFlex offers machinists the right combination of performance and value for professional honing applications. Flexible filaments provide the correct pressure to create an ideal hone; one bore after another. It's the ideal tool to create cross-hatch patterns for improved oil retention and increased part efficiency. The strong self-centering system leaves a smooth, even surface finish free of metal burrs whether used in a manual or automated application.



Deburring cross holes in a firearms component.

No matter what type or size cylinder, Weiler's CrossFlex brushes deliver the options you need to solve your toughest deburring and honing challenges.

FEATURES & BENEFITS:

- Desired Finish**
 CrossFlex offers a wide range of grits and sizes allowing machinists to achieve the desired finish.
- Heavy Burr Removal**
 Increased brush to part contact ensures that the heaviest burrs will be removed, outperforming standard nylon tube brushes.
- Long Life**
 CrossFlex brushes have a long operational life, lowering total cost of use compared to other brush options.
- Flexible Nylon Stems**
 Distribute pressure evenly and self centers within the part to create an ideal hone.
- Consistent Cross Hatch Pattern**
 Helps to seat piston rings and retains oil for lubrication in a combustion cylinder.
- Collet Ready Brushes**
 Deliver a true center rotation and exceptional brush balance for automated applications or hand held use.

CROSSFLEX FOR COMMON ENGINE BORES

Engine Type	Bore	Recommended Brush
AMC 258	3.75	34272
AMC 304	3.75	34272
Buick 455	4.31	34280
Chevy 305	3.75	34272
Chevy 307	3.5	34268
Chevy 327	4.001	34276
Chevy 350	4	34276
Chevy 383	4	34276
Chevy 396	4.094	34276
Chevy 400	4.125	34280
Chevy 427	4.251	34280
Chevy 454	4.251	34280
Chevy LS1	3.898	34276
Dodge 318	3.91	34276
Dodge 340	4.04	34276
Dodge 426 Hemi	4.25	34280
Dodge 426 Wedge	4.25	34280
Dodge 440	4.32	34280
Dodge Chrysler Hemi 5.7L / 345	3.917	34276
Dodge Chrysler Hemi 5.7L / 345	4.055	34276
Dodge Chrysler Hemi 5.7L / 345	4.09	34276
Ford 289	4	34276
Ford 302	4	34276
Ford 351	4	34276
Ford 352	4	34276
Ford 390	4.05	34276
Ford 406	4.125	34280
Ford 410	4.05	34276
Ford 427	4.2328	34280
Ford 428	4.125	34280
Pontiac 389	4.062	34276

Deburring mounting holes on a machined component.



CROSSFLEX ABRASIVE GRITS: Every individual brush end tip is colored to indicate the grit of that brush.



COLLET READY BENEFITS FOR SMALL DIAMETER BRUSHES:

- Reduces brush run-out
- Strengthens and sturdies brush shaft for better stability and overall reach
- Strong positive engagement with tool holder



Collet ready CrossFlex brush in a CNC machine.

SMALL DIAMETER CROSSFLEX HONING BRUSHES

Silicon carbide cross-honing brushes for standard use. Ideal for deburring small diameter cross hole intersections.



For Hole Sizes in Inches	For Hole Sizes in mm	Length of Brush Part	Overall Length	Shank Diameter	Max RPM	120 Grit Item No.	180 Grit Item No.	240 Grit Item No.	320 Grit Item No.
0.177"	4.5 mm	0.787"	6"	0.083"	1,000	—	34105	34106	34107
0.1857"	4.7625 mm					—	34108	34109	34110
0.197"	5 mm	1.575"	7.875"	0.098"	900	34111	34112	34113	34114
0.217"	5.5 mm					34115	34116	34117	34118
0.236"	6 mm					34119	34120	34121	34122
0.25"	6.35 mm					34123	34124	34125	34126
0.276"	7 mm	1.969"	7.875"	0.13"	900	34127	34128	34129	34130
0.315"	8 mm					34131	34133	34134	34135
0.354"	9 mm					34136	34137	34138	34139
0.375"	9.5 mm					34141	34142	34143	34144
0.394"	10 mm					34145	34146	34147	34148
0.433"	11 mm					34149	34150	34151	34152
0.472"	12 mm	2.48"	7.875"	0.157"	900	34153	34154	34155	34156
0.5"	12.7 mm					34158	34159	34160	34161
0.552"	14 mm					34162	34163	34164	34165
0.625"	16 mm					34166	34167	34168	34169
0.709"	18 mm					34170	34171	34172	34173
0.75"	19mm					34174	34175	34176	34177
0.787"	20 mm	3"	7.875"	0.213"	900	34178	34179	34180	34181
0.875"	22 mm					34182	34183	34184	34185
0.9375"	23.8 mm					34186	34187	34188	34189



COLLET READY – SMALL DIAMETER CROSSFLEX HONING BRUSHES

Silicon carbide cross-honing brushes for standard use within automated applications and to reduced brush run-out.



For Hole Sizes in Inches	For Hole Sizes in mm	Length of Brush Part	Overall Length	Shaft Diameter	Max RPM	120 Grit Item No.	180 Grit Item No.	240 Grit Item No.	320 Grit Item No.
0.177"	4.5 mm	0.75"	6"	5/32"	1,000	—	34298	34299	34359
0.188"	4.763 mm					—	34300	34301	34302
0.197"	5 mm	1.5"	7.875"	1/4"	900	34303	34304	34305	34306
0.217"	5.5 mm					34307	34308	34309	34310
0.236"	6 mm					34311	34312	34313	34314
0.25"	6.35 mm					34315	34316	34317	34318
0.276"	7 mm	2"	7.875"	1/4"	900	34319	34320	34321	34322
0.315"	8 mm					34323	34324	34325	34326
0.354"	9 mm					34327	34328	34329	34330
0.375"	9.5 mm					34331	34332	34333	34334
0.394"	10 mm					34335	34336	34337	34338
0.433"	11 mm					34339	34340	34341	34342
0.472"	12 mm	2.5"	7.875"	8 mm	900	34343	34344	34345	34346
0.5"	12.7 mm					34347	34348	34349	34350
0.552"	14 mm					34351	34352	34353	34354
0.625"	16 mm					34355	34356	34357	34358

COATED ABRASIVES
 NON-WOVEN ABRASIVES
 POWER BRUSHES
 NYLON BRUSHES
 PACKAGED ITEMS
 MAINTENANCE



Cleaning burrs out of an automotive head port.



MEDIUM DIAMETER CROSSFLEX HONING BRUSHES

Silicon carbide cross-honing brushes for standard use. Ideal for changing the surface finish in machined bores and deburring the ID of castings.



For Hole Sizes in Inches	For Hole Sizes in mm	Length of Brush Part	Overall Length	Shank Diameter	Max RPM	120 Grit Item No.	180 Grit Item No.	240 Grit Item No.	320 Grit Item No.
1"	25.4 mm	3"	7.875"	0.213"	900	34190	34191	34192	34193
1.125"	29 mm			0.224"	800	34194	34195	34196	34197
1.25"	31.8 mm			0.252"	34198	34199	34200	34201	
1.375"	35 mm			34202	34203	34204	34205		
1.5"	38 mm			34206	34207	34208	34209		
1.625"	41 mm			34210	34211	34212	34213		
1.75"	45 mm			34214	34215	34216	34217		
1.875"	47.6 mm			34218	34219	34220	34221		
2"	51 mm			34222	34223	34224	34225		
2.125"	54 mm			0.283"	700	34226	34227	34228	34229
2.25"	57 mm					34230	34231	34232	34233
2.375"	60 mm					34234	34235	34236	34237
2.5"	64 mm					34238	34239	34240	34241
2.625"	67 mm					34242	34243	34244	34245
2.75"	70 mm	34246	34247			34248	34249		
2.875"	73 mm	34250	34251			34252	34253		
3"	76 mm	34254	34255			34256	34257		



HEAVY-DUTY MEDIUM DIAMETER CROSSFLEX HONING BRUSHES

Silicon carbide cross-honing brushes for heavy-duty use. Ideal for changing the surface finish in machined bores and deburring the ID of castings.

For Hole Sizes in Inches	For Hole Sizes in mm	Length of Brush Part	Overall Length	Shank Diameter	Max RPM	120 Grit Item No.	180 Grit Item No.	240 Grit Item No.	320 Grit Item No.
3"	76 mm	5.5"	13.5"	0.311"	700	34258	34259	34260	34261
3.25"	83 mm					34262	34263	34264	34265
3.5"	89 mm					34266	34267	34268	34269



34274



34294



Engine cylinder head honing.

HEAVY-DUTY LARGE DIAMETER CROSSFLEX HONING BRUSHES

Silicon carbide cross-honing brushes for heavy-duty use. Ideal for cross hatching in combustion cylinders.



For Hole Sizes in Inches	For Hole Sizes in mm	Length of Brush Part	Overall Length	Shank Diameter	Max RPM	120 Grit Item No.	180 Grit Item No.	240 Grit Item No.	320 Grit Item No.
3.75"	95 mm	5.5"	13.5"	0.311"	700	34270	34271	34272	34273
4"	101 mm	6.5"		0.346	600	34274	34275	34276	34277
4.25"	108 mm		34278	34279		34280	34281		
4.5"	114 mm		34282	34283		34284	34285		
5"	127 mm		34286	34287		34288	34289		
5.5"	140 mm	18"	0.402"	34290	34291	34292	34293		
6"	152 mm			34294	34295	34296	34297		

SPECIALTY BRUSHES

Weiler understands that not all your finishing or deburring applications have a standard solution. For instances where applications require unique sizes, lengths or abrasives; Weiler Process Solutions (WPS) specialists work with you to provide custom CrossFlex brushes for your specific application.

- Custom sized for your specific bore diameters
- Brushes with shorter or longer stems for your particular application
- Collet ready or other connection methods
- Options in a variety of abrasives including **silicon carbide, aluminum oxide, zirconia alumina** and **ceramic** grains



Custom large diameter ceramic CrossFlex brush.



An application engineering program designed to provide Weiler customers with engineering support to identify value added opportunities in their processes.

To learn more about Weiler's specialty solutions go to: weilerabrasives.com/wps

MINIATURE BRUSHES



Removing galled spots from a metal forming die.

THE WEILER FAMILY began producing miniature brushes for the jewelry industry in 1898, and their tradition of providing the highest quality, most cost-effective products continues to this day.

Weiler's line of miniature brushes are designed for precision cleaning, light deburring, and finishing applications in a variety of crafts, trades, and industries. In addition to use in jewelry production and in dental and optical labs, miniature brushes have many applications in modern industries such as electronics and instrumentation production, aerospace and aircraft manufacture, and precision tool and die shops. They are permanently mounted on 1/8" or 3/32" stems for quick mounting and efficient use on high-speed electric rotary tools and air-powered pencil die grinders.

APPLICATIONS

- Decorative finishing
- Light deburring and edge blending
- Buffing and polishing of small parts
- Light-duty cleaning



P WIRE WHEEL BRUSHES - Fine crimped wire fill for light-duty cleaning and deburring.

Diameter	Wire Size	Trim Length	Stem Size	Stem Length	Max. RPM	Standard Pack	Item Number		
							Steel	Stainless	Brass
5/8"	.005	1/8"	1/8"	1-1/2"	37,000	144	—	99554	—
3/4"	.003	3/16"	1/8"	1-1/2"	37,000	144	26000	—	26001 •
	.005						26003	26005	26004 •
3/4"	.003	3/16"	3/32"	1-1/2"	37,000	144	26140 •	—	26141 •
	.005						26143	—	26144
1"	.003	5/16"	1/8"	1-1/2"	37,000	144	26012	26014	—
	.005						26015	26017	26016
	.005						26155 •	—	—
1-1/4"	.005	3/8"	1/8"	1-1/2"	37,000	144	26021	—	—
1-1/2"	.005	1/2"	1/8"	1-1/2"	25,000	144	26296	26294	—

• Non-stock product, contact Customer Service for lead times and minimum order quantities.

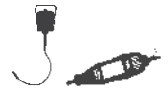

P BRISTLE WHEEL BRUSHES - Natural hair fill for scratch-free cleaning of small parts or for buffing and polishing of features such as slots and grooves using abrasive compounds.

Diameter	Fill Type	Trim Length	Stem Size	Stem Length	Max. RPM	Standard Pack	Item Number	
3/4"	Stiff Hair	3/16"	3/32"	1-1/2"	37,000	144	26041	
	Soft Hair						26042	
	Stiff Hair*						26043	
	Stiff Hair						1/8"	26059
								* Double thick

* Double thick

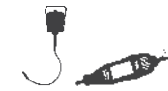

P WIRE CUP BRUSHES - Fine crimped wire fill for light-duty cleaning or deburring in confined areas.

Dia.	Wire Size	Trim Length	Stem Size	Stem Length	Overall Length	Max. RPM	Standard Pack	Item Number		
								Steel	Stainless	Brass
5/8"	.003	1/4"	1/8"	1-1/2"	2"	37,000	144	26071	—	26072
	.005							26074	26076	26075

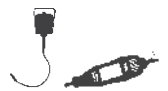

P BRISTLE CUP BRUSHES - Natural hair fill for scratch-free cleaning of confined areas or for buffing and polishing of small recessed surfaces using abrasive compounds.

Dia.	Fill Type	Trim Length	Stem Size	Stem Length	Overall Length	Max. RPM	Standard Pack	Item Number
1/2"	Stiff Hair	7/32"	3/32"	1-1/2"	2"	37,000	144	26091
9/16"	Stiff Hair	1/4"	1/8"	1-1/2"	2"	37,000	144	26093
	Soft Hair							26094 •
1"	Stiff Hair	7/16"	1/8"	1-1/2"	2-3/8"	25,000	144	26095
	Soft Hair							26096 •



• Non-stock product, contact Customer Service for lead times and minimum order quantities.

P WIRE END BRUSHES - Fine crimped wire fill for light-duty cleaning or deburring in very small recessed areas or ID's.



Dia.	Wire Size	Trim Length	Stem Size	Stem Length	Overall Length	Max. RPM	Standard Pack	Item Number		
								Steel	Stainless	Brass
3/16"	.003	1/4"	1/8" 3/32"	1-1/4"	1-7/8"	37,000	144	26098 26101	26099 -	26097 -
1/4"	.005	7/16"	1/8"	1-1/4"	2-1/8"	37,000	144	26107	26108	26106
5/16"	.005	9/16"	1/8"	1-1/4"	2-3/8"	25,000	144	26113	26114	-

• Non-stock product, contact Customer Service for lead times and minimum order quantities.



P BRISTLE END BRUSHES - Natural hair fill for scratch-free cleaning or for buffing and polishing of very small recesses using abrasive compounds.



Dia.	Fill Type	Trim Length	Stem Size	Stem Length	Overall Length	Max. RPM	Standard Pack	Item Number
3/16"	Stiff Hair Soft Hair Stiff Hair	1/4"	1/8"	1-1/4"	1-7/8"	37,000	144	26115 26122 26116
1/4"	Stiff Hair	3/8"	1/8"	1-1/4"	2-1/8"	37,000	144	26119
5/16"	Stiff Hair	9/16"	1/8"	1-1/4"	2-3/8"	25,000	144	26121



P BRISTLE END BRUSHES - Plastic Ferrule

Feature a plastic ferrule or cup to protect internal surfaces during use.



Dia.	Fill Type	Trim Length	Stem Size	Stem Length	Overall Length	Max. RPM	Standard Pack	Item Number
3/16"	Stiff Hair	1/4"	1/8"	1-1/4"	1-7/8"	37,000	144	26128
1/4"	Stiff Hair	3/8"	1/8"	1-1/4"	2-1/8"	37,000	144	26131
5/16"	Stiff Hair	9/16"	1/8"	1-1/4"	2-3/8"	25,000	144	26133



P ABRASIVE NYLON END BRUSHES - Plastic Ferrule - Nylox® abrasive nylon fill for buffing and polishing without compounds. They can also be used in automated applications for precision deburring and finishing of small part features.



Dia.	Filament Dia./Grit	Trim Length	Stem Size	Stem Length	Overall Length	Max. RPM	Standard Pack	Item Number
3/16"	.018/500	1/4"	1/8"	1-1/4"	1-7/8"	37,000	144	26136
1/4"	.018/500	3/8"	1/8"	1-1/4"	2-1/8"	37,000	144	26138
5/16"	.018/500	9/16"	1/8"	1-1/4"	2-3/8"	25,000	144	26146



Deburring the I.D. of a small machined part with miniature wire end brush.



WHY WEILER
BONDED ABRASIVES
COATED ABRASIVES
NON-WOVEN ABRASIVES
POWER BRUSHES
NYLOX BRUSHES
PACKAGED ITEMS
MAINTENANCE

NON-SPARKING BRUSHES



Creating an antique finish on a brass plate.

Weiler offers an assortment of wire non-sparking brushes featuring high-quality bronze or brass wire that offer a very soft brushing action in comparison to steel and stainless steel and will not generate a spark when used on metal surfaces. These products are available in a variety of knot wire and crimped wire configurations for use in a broad range of surface cleaning applications, and they are manufactured with individual knot hole and solid ring construction for high performance and long life. Weiler's non-sparking power brushes are available with plain arbor holes, nuts, and permanently-attached stems for use on a variety of tools.



APPLICATIONS

- Light to medium duty cleaning of surfaces, recesses, and ID's
- Deburring component parts machined from soft, non-ferrous metals
- Cleaning molds and dies in the injection-molding and extrusion of plastics
- Maintenance activities in areas where flammable or potentially explosive materials are present, such as refineries and petrochemical plants.



13121

P **STANDARD TWIST WHEELS** provide a heavy-duty brushing action with some flexibility; ideal for more demanding cleaning applications.



Dia.	Wire Size	Arbor Hole	No. of Knots	Face Width	Trim Length	Max. AH Avail.	Thickness at Face Plates	Max. RPM	Std. Pack	Item Number Bronze
3"	.020	1/2" - 3/8"	20	3/8"	5/8"	1/2"	7/16"	25,000	10	08271
4"	.020	5/8" - 11	24	1/2"	7/8"	-	7/16"	20,000	5	13121

For threaded arbor hole adapters see page 71.



01475

P **CRIMPED WIRE WHEELS** provide a flexible brushing action and consistent performance for light-duty cleaning and deburring applications.



Diameter	Wire Size	Arbor Hole	Face Width	Trim Length	Max. AH Avail.	Thickness at Face Plates	Max. RPM	Standard Pack	Item Number Brass
6"	.005	5/8"-1/2"	1/2"	1-7/16"	1-1/4"	7/16"	6,000	2	01415
	.0118								01475

For arbor hole adapters see page 82. For other available arbor holes, see Arbor Hole Variations Table on page 61.



29078

P **SMALL DIAMETER CRIMPED WIRE WHEELS** provide a flexible brushing action and consistent performance for light-duty cleaning and deburring applications requiring a small wheel.



Diameter	Wire Size	Arbor Hole	Face Width	Trim Length	Max. RPM	Standard Pack	Item Number Brass
1-1/2"	.005	3/8"	1/4"	7/16"	20,000	10	29178
2"	.005	1/2"	3/8"	1/2"	20,000	10	29059
	.0118						29086
3"	.014	1/2"	5/8"	1"	20,000	10	29078

For adapters and drive arbors see page 79.



17641

P **CONFLEX BRUSH** - Small diameter wheels permanently mounted onto a 1/4" stem to provide a very flexible brushing action.



Diameter	Wire Size	Face Width	Trim Length	Max. RPM	Standard Pack	Item Number Brass
3"	.0118	1/2"	1"	20,000	10	17641 ■

■ Packaged product available. See pages 141-142 for details.



13299

P **KNOT WIRE CUP BRUSHES** provide heavy-duty brushing action with some flexibility for more demanding cleaning applications on relatively flat surfaces.



Diameter	Wire Size	Arbor Hole	Trim Length	Max. RPM	Standard Pack	Item Number Bronze
2-3/4"	.020	5/8"-11 UNC	1"	14,000	1	13299
4"	.020	5/8"-11 UNC	1-1/4"	10,200	1	12776

For threaded arbor hole adapters see page 71.

P **CRIMPED WIRE CUP BRUSHES** provide a very flexible brushing action for light-duty cleaning applications on somewhat irregular surfaces.



Diameter	Wire Size	Arbor Hole	Trim Length	Max. RPM	Standard Pack	Item Number	
						Bronze	Brass
3"	.020	5/8"-11 UNC	7/8"	14,000	1	13231	—
4"	.020	5/8"-11 UNC	1-3/8"	10,200	1	14616	—
5"	.014	5/8"-11 UNC	1-1/4"	9,000	1	—	14606
6"	.020	5/8"-11 UNC	1-1/4"	6,600	1	14316*	—

* With internal nut For threaded arbor hole adapters see page 71.



13231

P **UTILITY CRIMPED WIRE CUP BRUSHES** - Smaller diameter cup brushes that provide a flexible brushing action for light-duty cleaning applications.



Diameter	Wire Size	Trim Length	Stem Diameter	Overall Length	Max. RPM	Standard Pack	Item Number
							Brass
1-3/4"	.006 .0118	3/4"	1/4"	2-5/16"	13,000	10	14310 • 14314
2-3/4"	.0118	7/8"	1/4"	2-1/2"	6,000	1	14311

• Non-stock product, contact Customer Service for lead times and minimum order quantities.



14314

P **KNOT WIRE END BRUSH** features a hollow end and heavy-duty brushing action with some flexibility; ideal for more demanding cleaning applications in recessed areas.



Diameter	Wire Size	Trim Length	Stem Diameter	Overall Length	Max. RPM	Standard Pack	Item Number
							Bronze
1-1/8"	.020	7/8"	1/4"	2-5/8"	22,000	10	10067



10067

P **CRIMPED WIRE END BRUSHES** feature a solid end and very flexible brushing action ideal for light-duty cleaning applications in corners and hard-to-reach areas.



Diameter	Wire Size	Trim Length	Stem Diameter	Overall Length	Max. RPM	Standard Pack	Item Number
							Brass
1/2"	.005	7/8"	1/4"	2-9/16"	25,000	10	10158
1"	.005	7/8"	1/4"	2-5/8"	20,000	10	10128
1"	.0118	1"	1/4"	2-5/8"	22,000	10	10091



10158

P **DOUBLE STEM, DOUBLE SPIRAL POWER TUBE BRUSHES** - Constructed with four stem wires and a double spiral of straight wire fill material to provide a more aggressive internal cleaning action.



Diameter	Wire Size	Brush Part	Stem Diameter	Overall Length	Standard Pack	Item Number
						Brass
1/2"	.006	2"	5/32"	5"	10	21178
5/8"	.008	2"	7/32"	5"	10	21219
3/4"	.006	2-1/2"	1/4"	5-1/2"	10	21179
1"	.006	2-1/2"	1/4"	5-1/2"	10	21218



21178

P **ROUND POWER TUBE BRUSHES** feature a single continuous length of stainless steel stem wire and a single spiral of crimped wire fill for a more flexible brushing action; suitable for use on smooth or threaded blind holes.



Diameter	Wire Size	Brush Part	Stem Diameter	Overall Length	Standard Pack	Item Number
						Brass
1/4"	.004	1"	1/8"	3-1/2"	10	21332
1/2"	.005	1"	3/16"	3-1/2"	10	21182
1-1/2"	.008	1"	1/4"	3-1/2"	10	21152



21332

P **SINGLE STEM, SINGLE SPIRAL HAND TUBE BRUSHES** - Constructed using a single continuous length of galvanized steel stem wire and feature a formed eye loop for convenient hand use. The single spiral of straight wire fill allows for easy manual insertion into the ID.

Diameter	Wire Size	Brush Part	Stem Diameter	Overall Length	Standard Pack	Item Number
						Brass
3/16"	.003	1-1/2"	3/32"	7"	10	21221
1/4"	.003 .005	1-1/2"	3/32"	7"	10	21270 21139
3/8"	.004	2"	1/8"	8"	10	21191
1/2"	.004	2"	1/8"	8"	10	21165



21191

WHY WEILER
BONDED ABRASIVES
COATED ABRASIVES
NON-WOVEN ABRASIVES
POWER BRUSHES
NYLON BRUSHES
PACKAGED ITEMS
MAINTENANCE

WIDE FACE BRUSHES



Removing light corrosion and mill scale from coiled steel.

Cylindrical brush assemblies have proven to be reliable and economical tools for a wide variety of industrial surface conditioning applications. In addition to gang-mounting a series of individual wheel brushes onto a shaft or reusable arbor, one-piece wide face brush units can be manufactured to cover broad surfaces or provide maximum brushing action in a minimum amount of space.

Cylindrical brushes can be manufactured using several different styles of construction, and the characteristics of each style of construction can significantly affect brush performance. Weiler will custom-design a wide face brush in the most appropriate type of construction for your specific application. For more information and to schedule a consultation with a Weiler Process Solutions expert visit: weilerabrasives.com/wps.

APPLICATIONS

- Scrubbing debris from the surface of material during processing
- Removing corrosion, surface contamination, mill scale, or heat discoloration
- Roughening surfaces to promote adhesion or bonding
- Removing applied finishes and coatings
- Producing decorative surface finishes
- Deburring or finishing cylindrical parts
- Deburring the cut ends of tubing and extrusions



DISPOSABLE BRUSH ASSEMBLIES - Wide face assemblies for brushing flat surfaces can be manufactured as disposable units with a variety of available fill materials depending on the specific application. Available fills include; metallic filaments such as steel, stainless steel, or brass crimped wire; Nylox® nylon abrasive filaments; synthetic filaments such as nylon or heat-stabilized polypropylene; or natural fibers such as tampico.

Disposable mountings can be constructed of carbon steel or stainless steel components, and “flow-through” mountings which allow coolant to be circulated through the core and out the face of the brush are available for wet applications.

REFILLABLE BRUSH ASSEMBLIES - Wide face assemblies for brushing flat surfaces can also be manufactured as a replaceable brush unit wound onto a permanent and reusable arbor. Depending on the specific application and production environment, refilling reusable arbors may be a more economical option than using disposable units. Reusable mountings can be designed by Weiler or supplied by the customer.

In addition to the secondary operations such as nibbling and grinding of the brush face and dynamic balancing of the completed unit, Weiler also offers maintenance services on mounting hardware like collars and bearings.

TUBE END DEBURRING BRUSHES - Cylindrical rotary brushes are an ideal media for production applications involving the batch deburring of the ends of tubing that has been cut-to-length. Automated brushing systems are readily available and considerably less expensive to purchase and operate than chamfering machines.

Brush deburring machines can be integrated with cut-off operations to eliminate work-in-process and increase throughput, and they are flexible enough to be quickly adjusted for various shapes, sizes, and lengths of tubing. Unlike chamfering operations, brush deburring does not leave secondary burrs, brushing equipment is more tolerant of slight variations in machine set-up and tube length, and quality brushes last much longer than cutting inserts on double-end finishers.

Tube end deburring brushes are most commonly manufactured as disposable assemblies that are then mounted onto keyed shafts. High-tensile steel, hard-drawn steel, and Type 302 stainless steel wire are the most common fill materials used in tube end deburring brushes. Weiler offers high quality brushes with wire sizes from .006 to .020 and four available levels of fill density so that the brushing performance can be tailored to the material, burr condition, and budget of the end-user.

CUSTOM TUBE END DEBURRING BRUSHES - Please use the appropriate specification sheet on the next page when requesting a quotation on a custom tube end deburring brush.

NEED HELP?

For more information and to schedule a consultation with a Weiler Process Solutions expert visit: weilerabrasives.com/wps. To discuss specific requirements with a specialist call: 800-835.9999.

BRUSH-TUBE ORIENTATION

Brush-tube orientation determines which edges of the tube are deburred. The illustrations below show three orientations and the target edge.

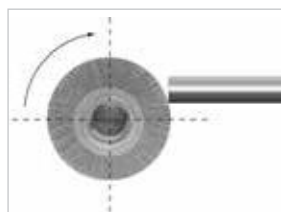

Deburring Tube I.D.

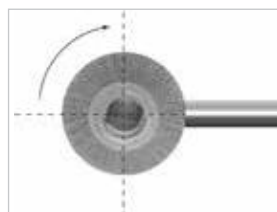

Deburring Tube I.D. and O.D.

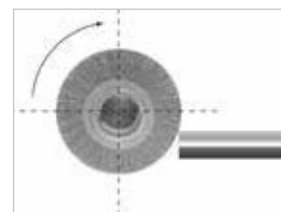

Deburring Tube O.D.

WIDE FACE BRUSH SPECIFICATION SHEET:

To help us accurately quote a wide face brush for your application, please provide the following information:

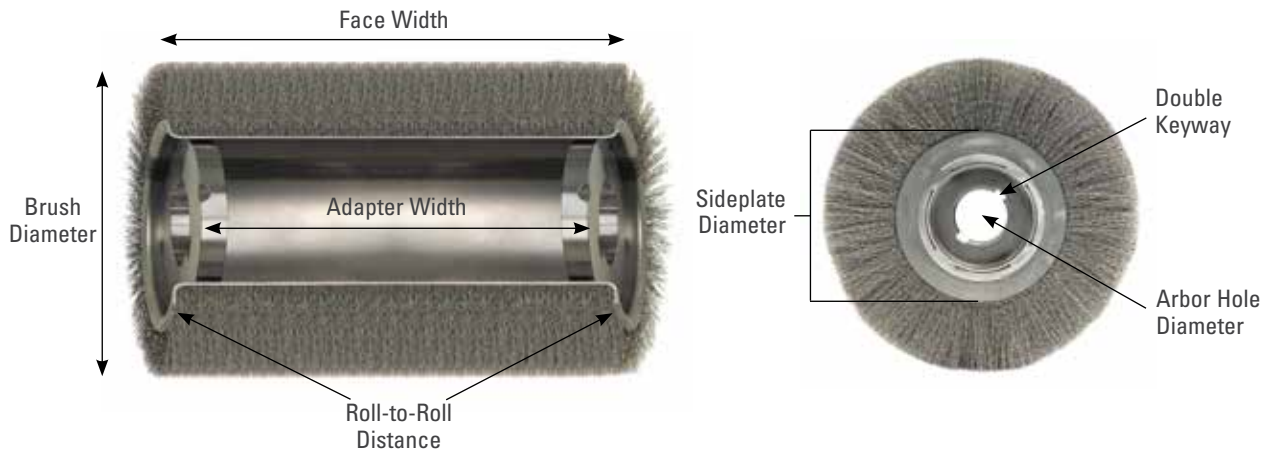

_____ Brush Diameter (Note: Tolerance is +/- 1/16")

_____ Fill Material _____ Fill Diameter

Fill Density: Economy General Purpose Heavy-Duty High Performance

_____ Face Width (Note: Tolerance is +/- 1/4")

_____ Roll-to-Roll Distance - Through Arbor Dimension (Note: Tolerance is +/- 1/8")

Brush can be manufactured holding the face width dimension or the roll-to-roll distance, not both.

_____ Sideplate Diameter

Standard sizes:

6" brush = 3-3/4" O.D.

8" brush = 5-1/4", 5-1/2" or 6-1/2" O.D.

>8" brush = 5-1/2" or 6-1/2" O.D.

_____ Maximum Operating RPM

_____ Adapter Width (Note: Adapters are 1/2" thick, tolerance on width spacing is +/- 1/8")

_____ Arbor Hole Diameter (Note: Clearance of 0.003" with additional tolerance of + 0.004" - 0 will be added)

Keyway(s) Required Single Double Keyway Width _____ Keyway Depth _____

Intended Brush Use: _____

Name: _____

End-User Name: _____

Company Name: _____

City: _____

Address: _____

State: _____ Zip: _____

Phone: (_____) _____

Fax: (_____) _____

E-mail: _____

FOR ADDITIONAL INFORMATION CALL:

To discuss specific requirements with a specialist call: 800-835.9999

FAX SPECIFICATION SHEET TO:

Customer Service
Fax: 800-635-3615

SUBMIT FORM ONLINE:

weilerabrasives.com/wide-face-brushes

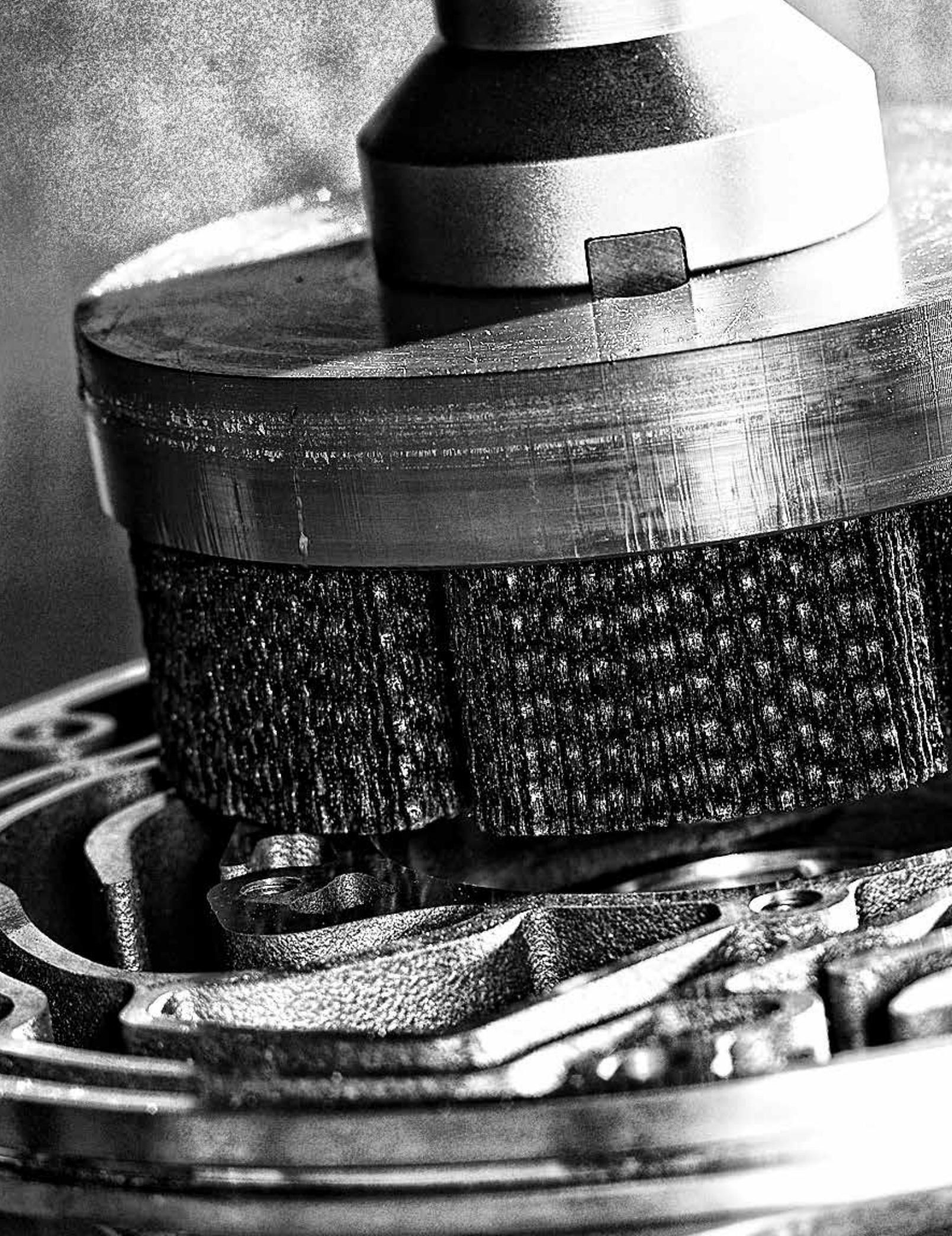



INCREASE PRODUCTIVITY

Combining cutting-edge technology and product innovation, Nylox abrasive nylon filament brushes were developed to provide increased productivity, thereby cutting production costs. Nylox brushes were specifically designed as flexible deburring and edge radiusing tools for CNC, robotic and automated processes.

The nylon filaments of these brushes are impregnated with abrasive grain. As the nylon wears, new sharp grains are constantly exposed to the work surface, enabling the brush to maintain consistent brushing action throughout its life.

Technical Information	110-116
Engineered Products & Solutions	117
Troubleshooting Guide	118
Small Feature Deburring Products	119-123
Flat Surface Deburring Products	124-127
Targeted Feature Deburring Products	128-130
Application Engineered Wheels	131
Adapters & Drive Arbors	132-133
FME Area Product Solutions	134

MYLOX[®]

BRUSHES

SOLUTIONS SHOWCASE

TRANSMISSION VALVE BODY

Problem: Burrs on transmission components can break away from parent components during use and cause transmission wear and eventual failure. Therefore, fluid passages must be completely burr-free.

Solution: A 10" Nylox® disc brush operating at 825 RPM in a vertical CNC machining center is an ideal solution for deburring this component. Since all of the burrs are on a single plane, the non-directional nature of a Nylox disc brush produces a part on which all edges have been uniformly deburred.



STEERING COMPONENT

Problem: Manual deburring can be costly in many respects. Hard deburring tools and aggressive abrasive wheels do not allow much margin for operator error and the result is often high scrap rates.

Solution: Nylox brushes produce a flexible filing action that concentrates all of the abrasive cutting action on sharp edges, giving them the ability to remove burrs without altering overall part dimensions. For example, a 6" Burr-Rx® wheel mounted onto a 1,725 RPM pedestal buffer is capable of deburring this steering component just as quickly as a convolute wheel but without the fear of over-radiusing the edges of the teeth or producing flat spots.

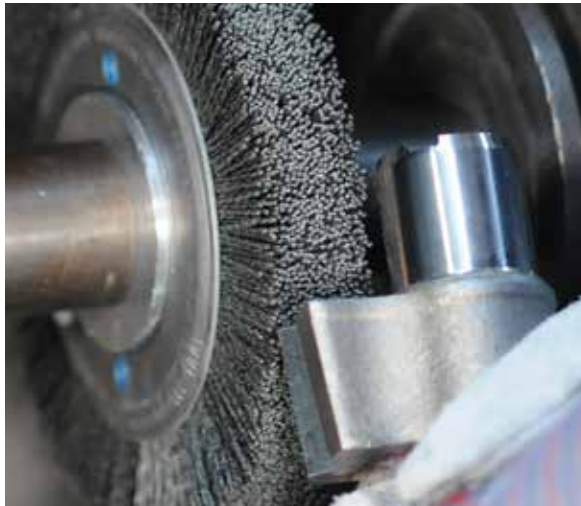

TOOL STEEL DEBURRING

Problem: Traditional nylon abrasive brushes were not sufficiently aggressive to remove large burrs from materials like tool steels and stainless steels.

Solution: Weiler's next generation filament technology, embodied in the company's line of Burr-Rx brushes, creates sufficient aggression to handle the toughest deburring jobs. This enables more users to capture the benefits offered by in-machine deburring.

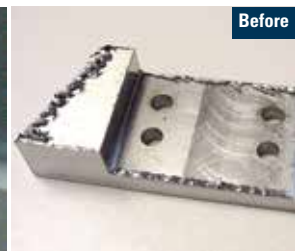
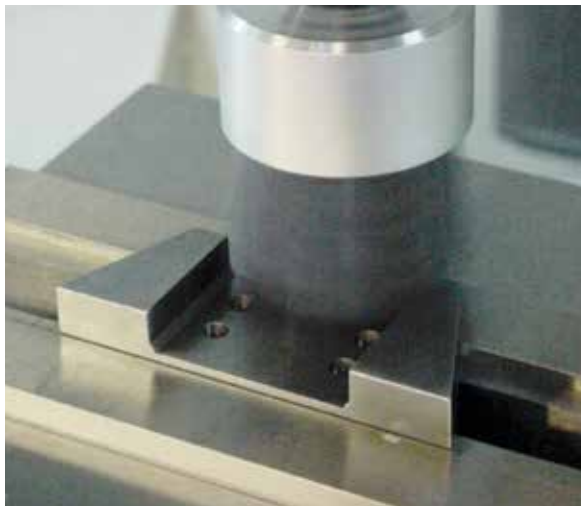

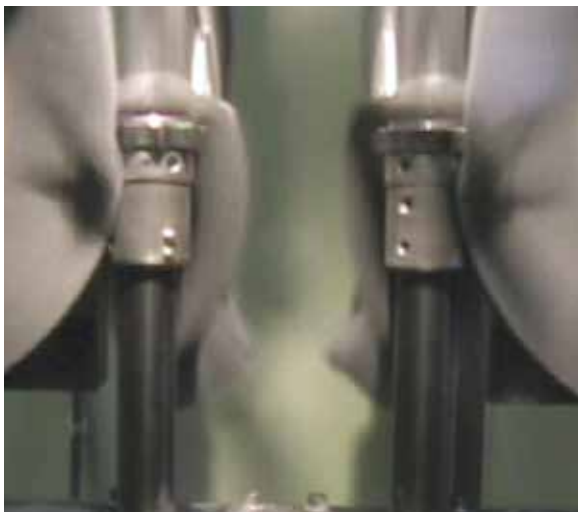

Before



After

PUMP GEAR

Problem: Pumps are extremely susceptible to failure due to burrs. Due to the tight fit between components, all edges must be deburred and radiused to ensure proper function. Proper deburring of rotating pump gears is especially important.

Solution: A dedicated machine running 14" Nylox® wheel brushes at 900 RPM was a low-cost solution for deburring these gears. By using dedicated equipment, cycle time was minimized and an acceptable edge condition was achieved.



Before



After

CAST ALUMINUM HOUSING

Problem: Although deburring the face-milled surfaces of castings is a very straight forward application for Nylox disc brushes, the limited availability of valuable machine time can be a perceived obstacle that prevents users from reaping the many benefits of implementing in-machine deburring operations.

Solution: The advanced ceramic grain technology of Weiler's Burr-Rx® tools offer a deburring action that is up to 400% greater than traditional abrasive nylon brushes that contain silicon carbide or aluminum oxide filaments. This allows Burr-Rx deburring tools to be used at feed rates that dramatically reduce the amount of additional machine time required to perform a brushing operation.



Before



After

TURBINE BLADE

Problem: Protecting turbine engine components against high-temperature fatigue is critical to ensure safe, reliable engine operation. Component edges must be burr-free and generally require an edge radius in the range of 0.005" to 0.060".

Solution: Robots are extremely well-suited for this application because they can manipulate the component in many orientations in relation to the brush. Weiler works closely with users and robot integrators to develop products and process programs that maximize brush life while generating exceptional part quality and consistency.

Photo courtesy of ACME Manufacturing.

SELECTING THE RIGHT BRUSH



WHERE TO START?

Sometimes it's necessary to design and manufacture a unique, custom-tailored product to meet your application requirements. Although Weiler offers such engineered solutions in all of our product lines, the innovative construction and value-added nature of the Nylox® line of nylon abrasive filament brushes showcases the creativity and expertise of our Application Engineering Team in designing products that have been tailored to the needs of the customer.

- Custom-engineered Nylox brushes can be designed and manufactured as variations on our standard products.
- Wide face brush assemblies for finishing flat surfaces or deburring cylindrical parts can also be designed and manufactured using Nylox nylon abrasive filaments. (See pages 100-101 for more information)

FOR SOLUTIONS TO DIFFICULT APPLICATIONS

If the problem is too complex to be solved over the phone, we will determine if an evaluation should be conducted at our in-house lab or the user's facility.

For more information and to schedule a consultation with a Weiler Process Solutions expert visit: weilerabrasives.com/wps. To discuss specific requirements with a specialist call: 800-835.9999.

TRIM LENGTH AND FILL DENSITY

To maximize brush life and reduce costs, always use the shortest trim, highest density brush that will adequately conform to the surface or part edges.

LONG TRIM, LOW DENSITY

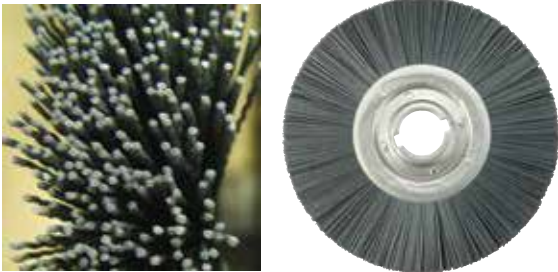

These brushes offer a greater degree of flexibility that is ideal for applications requiring a high degree of brush conformability. However, the lower fill density can result in shorter brush life and less consistent performance.

SHORT TRIM, HIGH DENSITY



These brushes work with a faster action and less engagement with the brush face. This produces shorter cycle times, more consistent performance and longer life in applications that do not require a high degree of brush conformability.

GRIT SIZE COLORS

Grit size is indicated by a dot on the product with the following colors:

- | | | | |
|-----------------------|------------------------|-----------------------|--------------------------|
| Black 46 Grit | Green 120 Grit | Gold 200 Grit | Purple 600 Grit |
| Red 60 Grit | Grey 180 Grit | White 320 Grit | Blue 1000 Grit |
| Yellow 80 Grit | Orange 240 Grit | Brown 500 Grit | Lt. Blue 800 Grit |
| | | | Pink 1200 Grit |

PRODUCT ADVANTAGES

PRODUCT ADVANTAGES

AGGRESSIVE YET COMPLIANT



- Nylox® brushes do not alter the overall dimensions or geometry of a part.
- Filament compliance allows these brushes to conform to complex part shapes and reduces the need for ultra-precise programming and fixturing.

IDEAL FOR AUTOMATION



- Abrasive grain is evenly distributed throughout the nylon filament.
- Extremely consistent performance throughout their product life.
- Ideal media for use in automated deburring and finishing processes.
- Ideal for dedicated production equipment or robotic cells.
- Can be directly integrated into the cycle of CNC machining centers.
- Improve part quality and consistency.
- Reduce direct labor cost.

IDEAL FOR DEBURRING

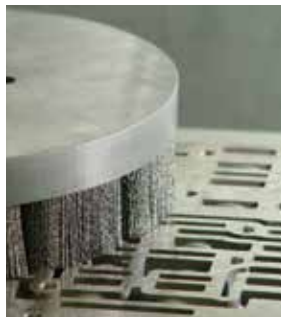

- Nylox filaments act like flexible files, deburring and radiusing edges as they wipe across them.
- Their limited aggression and flexible filing action also make them suitable for deburring a wider range of materials in comparison to wire-filled power brushes.

ENHANCED SURFACE FINISHES



- The compliant cutting action not only limits their ability to alter part dimensions, but it makes them an effective tool for refining surface texture characteristics without removing significant amounts of base material.
- Although they contain the same abrasive grain sizes, Nylox brushes will not generate the same prominent scratch pattern as a comparable coated abrasive product.

CONSTRUCTION ADVANTAGES

COMPETITOR'S METAL HUB

- Metal hub components are assembled under high pressure, potentially damaging the filaments and causing premature breakage.
- Retaining ring displaces filament material, creating a void in the center of the brush face.
- Lower fill density can result in shorter life and less consistent performance.



WEILER'S COMPOSITE HUB

- Molded hub construction eliminates filament breakage.
- Uniform distribution of fill material and superior balance.
- Higher fill density provides more aggressive brushing and longer life.
- Consistent performance as the brush wears.



WEILER'S COMPOSITE METAL HUB

- Filaments retained using the latest polymer technology to prevent filament breakage.
- Metal components add impact resistance and dimensional stability.
- The highest filament density in the market ensures lowest cost-per-part.



WEILER'S PVC SHELL MILL

The PVC construction results in a very consistent, flat brush face. Their high dimensional precision makes them suitable for the most critical applications. They perform more consistently from the first part to the last.



WEILER'S TUFTED FILAMENTS

This construction style offers increased aggression due to added filament density. This enables processing of severe burrs or generating larger edge radii in shorter cycle times. The longer trim length allows for greater conformability and longer life.

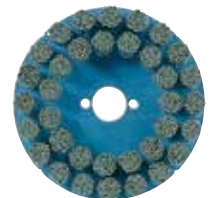

WEILER'S MAXIMUM DENSITY

Maximum density brushes are uniquely suited for demanding applications characterized by large burrs and rapid feed rates.



WHY WEILER

BONDED ABRASIVES

COATED ABRASIVES

NON-WOVEN ABRASIVES

POWER BRUSHES

NYLOX BRUSHES

PACKAGED ITEMS

MAINTENANCE

PRODUCT CHARACTERISTICS

WHEEL BRUSHES

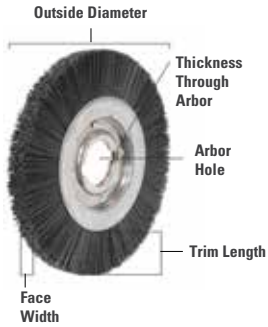

- Precision deburring of component parts after machining or grinding.
- Improving surface texture on machined or ground surfaces.
- Honing cutting tools and generating specific edge profiles and radii.
- Light duty cleaning and finishing of metals; light sanding of woods and composites.



DISC BRUSHES



- Deburring flat surfaces on machined components.
- Improving texture on machined or ground surfaces.
- Deburring face-milled castings or forgings.
- Blending tool marks after machining or grinding.



END BRUSHES



- Deburring flat surfaces on machined components.
- Improving texture on machined or ground surfaces.
- Deburring face-milled castings or forgings.
- Blending tool marks after machining or grinding.



TUBE BRUSHES

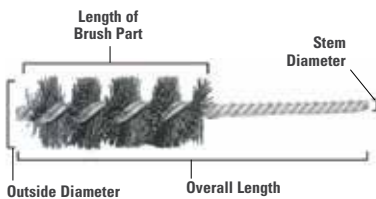

- Deburring and finishing applications in tubular component parts, drilled and tapered holes and machined bores and passages.



CROSSHOLE DEBURRING BRUSHES



- Deburring internal edges.
- Improving surface texture on internal bores.



FILAMENT CONFIGURATIONS

ROUND FILAMENTS - Due to their cross-sectional shape and the reduced contact with the work surface or part edges that result, round filaments provide a more compliant brushing action for less aggression and enhanced conformability.

RECTANGULAR FILAMENTS - Due to their shape, larger cross-sectional area and increased contact with the work, rectangular filaments provide a less compliant brushing action for much greater aggression and reduced conformability.

Crimping either type of filament along its length enhances conformability, allowing greater penetration of part edges into the brush face, often increases aggression. Crimped filaments are especially beneficial in maximum density disc brush designs.

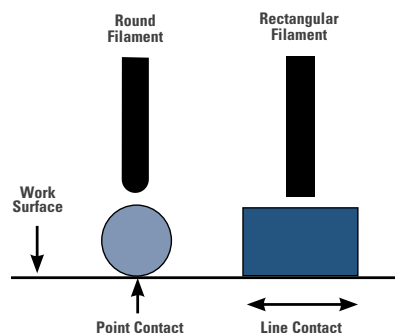

ABRASIVE FILAMENTS

Abrasive brush filaments are manufactured by extruding a mixture of liquefied polymer and abrasive grain. Unlike the filaments used in DIY grade abrasive brushes, industrial grade products like Weiler's Nylox® and Burr-Rx® brushes feature the highest grade of abrasive filament manufactured using a Type 6.12 nylon polymer. Industrial grade filaments also feature the highest quality abrasive materials that have been sifted and sorted to ensure that the grains are consistent in size. These grains may be one of four different types of abrasive:

- **ALUMINUM OXIDE (AO)** - is a duller, less aggressive grain typically used in finishing applications requiring a less pronounced scratch line pattern or deburring applications on materials where the use of SiC may be prohibited
- **BURR-RX CERAMIC (CG)** is an engineered abrasive grain that produces a superior cutting action and is compatible with the widest range of materials. It is the most effective grain available today!
- **SILICON CARBIDE (SIC)** is a sharp-edged grain that produces an effective cutting action. It is the most common grain used in industrial grade brushes.
- **DIAMOND FILAMENT** is a sharp-edged grain typically used for producing edge radii on hard materials like diamond, ceramic, CBN and glass.

ADVANTAGES OF BURR®-RX CERAMIC

Nylox brushes containing the Burr-Rx black ceramic filament provide the following advantages over SiC and AO filaments.

- 400% greater cutting action
- Most cost-effective deburring brush
- Deburr tougher materials
- Minimize cycle time
- Maximize tool life
- Reduce finishing costs
- Eliminate hand deburring

DEBURRING ACTION - BURR-RX (CG VS. SIC)

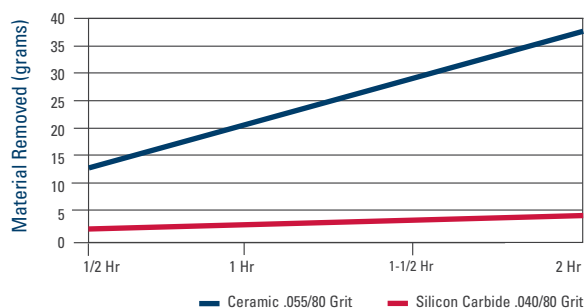

WHEEL VS. DISC BRUSH



Nylox wheel brushes are for applications where a targeted brushing action is required.



Disc brushes are for applications where the burrs lie along a single plane.

OPERATING INFORMATION

OPERATING PARAMETERS

Nylox® abrasive brushes work with a wiping and filing action. Think of them as flexible files. The sides of the Nylox filament actually do the work. To achieve a maximum edge radius and complete burr removal, parts should be buried into a slow running brush face. They work best when operated at speeds that allow

fairly deep penetration of the work-piece into the brush filaments. Usually, faster speeds do not work as well as slower speeds. The maximum RPM marked on the brush is not the optimum working speed. A good rule of thumb is to stay under 2,500 SFPM in dry applications and 3,500 SFPM in wet applications.

WHEEL BRUSHES PENETRATE 10% OF TRIM LENGTH



DISC BRUSHES 0.075" - 0.100" DEPTH OF INTERFERENCE



OPERATING SPEEDS - WHEEL BRUSHES

Diameter	RPM
2"	3,450 - 5,000
3"	2,500 - 3,450
4"	1,750 - 2,500
6"	1,350 - 1,750
8"	1,150 - 1,350
10"	950 - 1,150
12"	750 - 950
14"	650 - 850

OPERATING SPEEDS - DISC BRUSHES

Diameter	RPM
1-3/4" & 2"	1,750 - 2,000
3"-4"	1,500 - 1,750
5" - 6"	1,250 - 1,500
8"	800 - 1,000
10"	700 - 800
12"	600 - 700
14"	500 - 600

FEED RATE is determined by the amount of deburring, edge radiusing or surface finishing required and the type of material that is being processed. It is generally application specific. Slower feeds result in a more aggressive brushing action. Based on the brushing action desired for a specific application, the feed rate can be increased or decreased.

Material	SiC and AO Grain Feed Rate	Burr-Rx Grain Feed Rate
Non-Ferrous	50 in./min.	80 in./min.
Cast Iron	30 in./min.	60 in./min.
Mild Steel and Ductile Iron	25 in./min.	50 in./min.
Stainless and Alloy Steels	15 in./min.	30 in./min.
Titanium and High Nickel Alloys	10 in./min.	30 in./min.

RECOMMENDED MOTOR SIZES

Brush Diameter	Motor Size	RPM*
3"-4"	1/4 HP	3,450
6"	1/2 HP	1,725
8"	3/4 HP	1,725
10"	1 HP	1,140
12"	1 HP	1,140
14"	1-1/2 HP	900

Note: This chart is based on 1" brush face.

* A variable-speed motor control may be required to achieve optimum operating RPM; see operating speed charts above.

MINIMUM RECOMMENDED SPINDLE DIAMETER (from ANSI Standard B165.1)

Outside Dia. of Wheel Brush	Maximum Face Width of Wheel Brush	Minimum Outside Dia. of Spindle (Shaft)
2"	1/4"	1/4"
3"	3/4"	1/4"
3" (heavy-duty)	1"	3/8"
4"	1"	3/8"
6"	1-1/4"	1/2"
8"	1-1/4"	5/8"
10"	2"	3/4"
12"	3"	1"
14"	3"	1-1/4"
15"	3"	2"
16"	3"	2"

Note: These diameters are based on the wheel brush being mounted next to the supported end of the shaft rather than the unsupported end in order to minimize overhang.

COOLANT & WEAR COMPENSATION

COOLANTS

Nylox® brushes can be run dry, without coolants. However, certain deburring conditions such as higher speeds, material properties and greater depth of penetration can create excessive heat buildup, causing the nylon filaments to melt and smear on the work surface. If the speed or depth of penetration cannot be changed, coolants are recommended to overcome heat smear. Coolants will also help produce finer finishes.

WEAR COMPENSATION

On dedicated equipment, it is possible to automate wear compensation by using electronic controls to monitor the load on drive motors and adjust the position of the brushing tool to maintain a relatively consistent amount of interference or pressure. Since this is typically not possible with standard CNC machine tools, there are three other possible methods of compensating for tool wear for “in-machine” implementations of Nylox brushes.

AUTOMATIC INDEXING

Most CNC controllers allow tool wear compensation to be accomplished by programming a “macro” - routine to periodically adjust the position of the tool based upon the number of parts produced. Some experimentation may be required to determine the frequency and amount of adjustment that will result for most consistent performance and maximum brush life.

PROBING

If the machining center has the capability to probe the face of the brush, this feature can be used to gauge the true position of the filament tips. Adjustments to the brush position can then be made to maintain a consistent amount of interference between the tool and the part.

MANUAL

If the other methods cannot possibly be used, machine operators can adjust the brush position based on either statistical process control data or visual inspection of completed parts.

THE IDEAL TOOL PATH for a Nylox Disc brush is very similar to the path of the face mill that produced the burr. However, three differences exist:

- The rotation direction of the brush should be opposite of the cutting tool that created the burr.
- The length of the path must be longer than the part. Unlike a cutter path that can stop when the leading edge of the cutter reaches the end of the part, the tool path of a brush should continue until the trailing edge of the brush reaches the end of the part.
- The centerline of the brush may need to be off-set from the center of the part in order to maximize the number of filaments that strike the part at a perpendicular angle. This is especially important when the diameter of the brush is similar to the width of the part.

The part is deburred in the shortest cycle time with the lowest consumable cost-per-part.

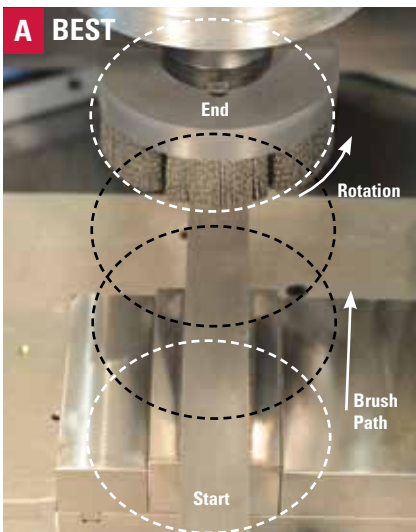

If a large diameter brush can be used, the centerline of the brush should be positioned on the center of the part. Ideally, the brush should be 3-4" wider than the part.

The part is deburred, but requires a longer cycle time. When a large brush will not fit in the tool changer, this method is recommended.

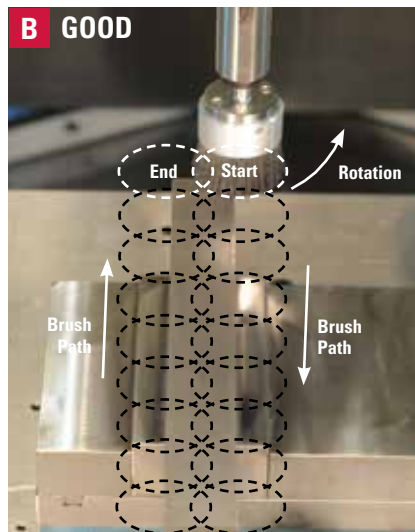

If a small diameter brush must be used, the centerline of the brush should be positioned on the edge of the part. This maximizes aggression by increasing the amount of perpendicular contact between the brush filaments and the burred edge.

Produces less deburring than A & B.

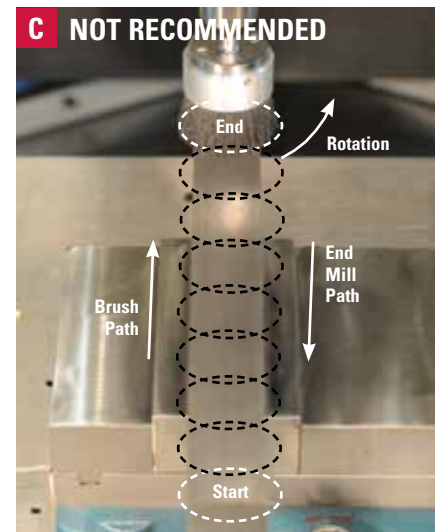

Positioning a small diameter brush with its centerline on the center of the part is not recommended. This configuration will not allow perpendicular contact of the filaments against the burred edge.

COOLANT COMPATIBILITY



NYLOX® BRUSHES IN AUTOMATED ENVIRONMENTS

MYTH: The abrasive grain in the Nylox brush will affect the accuracy of the equipment over time.

FACT: The abrasive grain in the Nylox brushes will not result in accelerated machine wear over time when used with proper filtration (50-micron or finer).

Automotive Case Study

In the auto industry a five year study was conducted on the use of Weiler Nylox brushes with silicon carbide (SiC) grain in the manufacturing of aluminum intake and exhaust manifolds. Over the period of the study, there was no noticeable difference in way wear between machines that ran brushes and those that did not. A 50-micron coolant filter worked as specified to remove the residuals from the brushing process.

Aerospace Case Study

A three year study was conducted on the use of Weiler Nylox brushes with ceramic grain (CG) in the manufacture of jet engine components. Over the period of the study, there was no loss in accuracy in the aerospace manufacturer's machines. A 50-micron coolant filter worked as specified to remove the residuals from the brushing process.



ENGINEERED PRODUCTS AND CUSTOMIZED SOLUTIONS



Two members of our Application Engineering Team discuss the results after testing an engineered product.

WE PROVIDE YOU WITH THE MOST COST-EFFECTIVE APPLICATION SOLUTIONS

Sometimes it is necessary to design and manufacture a unique, custom tailored product to meet your application requirements. Although Weiler offers such engineered solutions in all of our product lines, the innovative construction and value-added nature of the Nylox® line of nylon abrasive filament brushes showcases the creativity and expertise of our Application Engineering Team in designing products that have been tailored to the needs of the customer.

- Custom-engineered Nylox brushes can be designed and manufactured as variations on standard product configurations such as wheel, disc, cup, end, or tube brushes.
- Weiler's exclusive Burr-Rx® and Bore-Rx™ brushing tools can be engineered to meet the demands of a specific application.
- Wide face brush assemblies for applications such as finishing flat surfaces or deburring cylindrical parts can also be designed and manufactured using Nylox nylon abrasive filaments. (See pages 94-95 for more information)

FOR SOLUTIONS TO DIFFICULT APPLICATIONS

If the problem is too complex to be solved over the phone, we will determine if an evaluation should be conducted at our in-house lab or the user's facility.

For more information and to schedule a consultation with a Weiler Process Solutions expert visit: weilerabrasives.com/wps. To discuss specific requirements with a specialist call: 800-835.9999.



TROUBLESHOOTING GUIDE

There are many variables in Nylox® applications. If the Nylox brush you are using does not accomplish the desired results, select a solution from the suggestions below for your specific application.

Problem	Recommended Solutions
Brush not aggressive enough	<ul style="list-style-type: none"> • Increase filament diameter and/or grit size • Increase filament density by using round straight rather than round crimped • Increase surface contact by using rectangular rather than round • Increase pressure/depth of interference • Increase surface speed by increasing spindle RPM • Use a larger diameter brush • Reduce trim length or feed rate
Brush too aggressive	<ul style="list-style-type: none"> • Reduce filament diameter and/or grit size • Reduce filament density by using round crimped rather than round straight • Reduce surface contact by using round rather than rectangular • Reduce pressure/depth of interference • Reduce surface speed by reducing spindle RPM • Use a smaller diameter brush • Increase trim length or feed rate
Brush not conformable enough	<ul style="list-style-type: none"> • Increase trim length • Reduce filament diameter • Reduce filament density by using round crimped rather than round straight or rectangular • Reduce surface speed by reducing spindle RPM • Reduce feed rate
Finer final finish required	<ul style="list-style-type: none"> • Increase surface speed by increasing spindle RPM • Decrease grit size • Use brush with a coolant
Coarser final finish required	<ul style="list-style-type: none"> • Reduce surface speed by reducing spindle RPM • Increase grit size • Use brush without a coolant
Filaments melt/smear on workpiece	<ul style="list-style-type: none"> • Reduce surface speed by reducing spindle RPM • Use a smaller diameter brush • Use brush with a coolant
Short brush life	<ul style="list-style-type: none"> • Increase filament density • Reduce pressure/depth of interference

NEED HELP?

For more information and to schedule a consultation with a Weiler Process Solutions expert visit: weilerabrasives.com/wps.
To discuss specific requirements with a specialist call: 800-835.9999.

SMALL FEATURE DEBURRING PRODUCTS

SMALL DIAMETER WHEELS

MADE IN
USA
WITH GLOBAL
MATERIALS

Ideal for recesses and internal features or delivering targeted brushing action to a specific area. Our Burr-Rx® black ceramic grain filament wheels deliver up to a 400% greater edge-cutting action compared to traditional silicon carbide and aluminum oxide filaments for the fastest, most aggressive action for minimum cycle times and maximum life.

APPLICATIONS

- Deburring keyways, slots and crosshole intersections
- Honing and finishing of cylindrical bores

BURR-RX® SMALL DIAMETER WHEELS - Metal Hub - Crimped Round Black Ceramic Filament

Diameter	Filament Dia./Grit	Arbor Hole	Face Width	Trim Length	Max. RPM	Standard Pack	Item Number
1-1/4"	.026/120	1/4"	5/16"	5/16"	10,000	10	17551
1-1/2"	.026/120	1/2"	3/8"	1/4"	10,000	10	17541
2"	.026/120	1/2"	3/8"	1/2"	10,000	10	17548
	.035/80						17555
	.055/80						17542
2-1/2"	.026/120	5/8"	1/2"	11/16"	10,000	10	17556
	.035/80						17557
3"	.026/120	1/2"	1/2"	1"	10,000	10	17565
	.035/80						17567
	.043/120						17568

Other diameters and grit sizes available upon request.

SMALL DIAMETER WHEELS - Metal Hub - Crimped Round Silicon Carbide Filament

Diameter	Filament Dia./Grit	Arbor Hole	Face Width	Trim Length	Max. RPM	Standard Pack	Item Number
1-1/8"	.022/120	1/4"	5/16"	1/4"	10,000	10	17532 •
1-1/4"	.022/120	1/4"	5/16"	5/16"	10,000	10	17535
1-3/8"	.018/500	1/4"	5/16"	3/8"	10,000	10	16310*
1-1/2"	.022/120	1/2"	3/8"	1/4"	10,000	10	17628
	.035/180						29353
2"	.018/500	1/2"	3/8"	1/2"	10,000	10	17533
	.022/320						17543
	.040/120						17633
2"	.022/120	5/8"	7/16"	7/16"	10,000	10	17629
	.022/320						29356
2-1/2"	.022/120	5/8"	1/2"	11/16"	10,000	10	29123
	.035/180						29280 •
	.035/180						29088
	.022/320						17563
3"	.022/120	1/2"	1/2"	1"	10,000	10	16315
	.040/120						16263
	.022/120						16315
	.022/320						16263

Other diameters and grit sizes available upon request. Aluminum oxide* • Non-stock product, contact Customer Service for lead times and minimum order quantities.

DRIVE ARBORS - For mounting small diameter wheels into a collet or chuck.



Arbor Diameter	Stem Diameter	Stem Length	Length of Shaft	For Brushes with Max. Dia. of	Overall Length	Max. RPM	Standard Pack	Item Number
Unthreaded Shaft								
1/4"	1/4"	1-1/8"	3/16"	2"	2-1/16"	20,000	5	07723
Threaded Shaft								
1/2"	1/4"	3/4"	3/4"	3"	1-3/4"	25,000	5	07724
5/8"	1/4"	3/4"	3/4"	3"	1-13/16"	25,000	5	07729
1/2"	1/4"	7/8"	3/4"	3"	1-11/16"	20,000	5	07721
1/4"	1/4"	1-1/16"	1-1/8"	2"	2-9/16"	20,000	5	07725

PLASTIC ADAPTERS for mounting small diameter wheels onto various arbor sizes.

Fixed Arbor Hole Size	Adapted Arbor Hole Size	Standard Pack	Item Number
1/2"	1/4"	10	04400
1/2"	3/8"	10	04401
5/8"	1/2"	10	04402



Deburring the edges of a machined aluminum component.



17568



17533



07723



07724



07729



07721



07725



04401



04402

NOTE

See adapters on pages 132-133

COATED ABRASIVES

NON-WOVEN ABRASIVES

POWER BRUSHES

NYLON BRUSHES

PACKAGED ITEMS

MAINTENANCE

END BRUSHES

MADE IN
USA
WITH GLOBAL
MATERIALS

Featuring an integral stem for convenient mounting into a tool holder or collet, Nylox® end brushes and miniature end brushes are suitable for addressing recesses and internal features, or delivering a targeted brushing action to a specific area on a part.

APPLICATIONS

- Deburring small recessed areas and internal part features
- Finishing slots and recessed surfaces on machined parts

Deburring small features on a powdered metal part.



86104

BURR-RX® END BRUSHES - Banded - Crimped Round Black Ceramic Filament - Mounted on 1/4" Stems

Diameter	Filament Dia./Grit	Trim Length*	Recommended RPM	Overall Length	Max. RPM	Standard Pack	Item Number
3/8"	.026/120	1/4"	4,500 - 5,000	2-3/8"	10,000	10	86098
	.043/120						86099
1/2"	.026/120	1/4"	4,500 - 5,000	2-7/16"	10,000	10	86100
	.043/120						86101
3/4"	.026/120	1/4"	4,200 - 5,000	2-7/16"	10,000	10	86102
	.043/120						86103
1"	.026/120	1/4"	3,500 - 3,800	2-5/8"	10,000	10	86104
	.043/120						86105
	.055/80						86097

* Trim length from bands

END BRUSHES - Banded - Crimped Round Silicon Carbide Filament - Mounted on 1/4" Stems

Diameter	Filament Dia./Grit	Trim Length*	Overall Length	Max. RPM	Standard Pack	Item Number
1/2"	.022/320	3/8"	2-9/16"	10,000	10	11160
	.035/180					11161
	.040/120					11162
3/4"	.035/180	3/8"	2-7/16"	10,000	10	11165
	.040/120					11166
1"	.035/180	3/8"	2-11/16"	10,000	10	11169
	.040/120					11170

* Trim length from bands



11166

END BRUSHES - Crimped Round Silicon Carbide Filament - Mounted on 1/4" Stems

Diameter	Filament Dia./Grit	Trim Length	Overall Length	Max. RPM	Standard Pack	Item Number
1/2"	.022/320	7/8"	2-9/16"	10,000	10	10172
	.035/180					10173
	.040/120					10174
3/4"	.022/320	7/8"	1-1/2"	10,000	10	10152
	.035/180					10153
	.040/120					10154
1"	.022/320	7/8"	2-3/4"	10,000	10	10155
	.035/180					10156
	.040/120					10157



10154



26136

MINIATURE END BRUSHES - Plastic Ferrule - Crimped Round Silicon Carbide Filament Mounted on 1/8" stems

Diameter	Filament Dia./Grit	Trim Length	Overall Length	Max. RPM	Standard Pack	Item Number
3/16"	.018/500	1/4"	1-7/8"	37,000	144	26136
1/4"	.018/500	3/8"	2-1/8"	37,000	144	26138
5/16"	.018/500	9/16"	2-11/32"	25,000	144	26146

MINI DISC BRUSHES

MADE IN USA
WITH GLOBAL MATERIALS

Featuring a precision machined aluminum cup, Weiler's mini-disc brushes are designed to be the most cost-effective media for applications requiring a smaller brushing tool.

APPLICATIONS

- Deburring flat surfaces on machined components
- Improving texture characteristics on machined or ground surfaces
- Deburring face-milled castings or forgings
- Blending tool marks after machining or grinding

BURR-RX® MINI DISC BRUSHES - Maximum Density - Crimped Black Ceramic Filament

Diameter	Filament Dia./Grit	Arbor Hole	Drive Arbor + Recommendation	Trim Length	Max. RPM	Standard Pack	Item Number
Round Filament							
2"	.026/120	3/8"	89029 or 89033	1-1/4"	4,500	2	86106
	.035/80					1	85738
	.043/120					2	86107
	.055/80					2	85733
3"	.026/120	3/8"	89029 or 89033	1-1/4"	4,500	1	86109
	.035/80						86013
	.043/120						86110
	.055/80						86111
Rectangular Filament							
2"	80	3/8"	89029 or 89033	1-1/4"	4,500	1	85736
3"	80	3/8"	89029 or 89033	1-1/4"	4,500	1	86014

+ See page 133 for drive arbor specifications.

MINI DISC BRUSHES - Silicon Carbide Filament

Diameter	Filament Dia./Grit	Arbor Hole	Drive Arbor + Recommendation	Trim Length	Max. RPM	Standard Pack	Item Number
Round Filament							
1-3/4"	.035/180	5/8"	89023 or 89024	1-1/4"	6,000	2	85753
	.022/120						85751 •
	.040/80						85750
Rectangular Filament							
1-3/4"	80	5/8"	89023 or 89024	1-1/4"	6,000	2	85752
2"	80	3/8"	89023 or 89024	1-1/4"	4,500	2	85773*
3"	80	3/8"	89023 or 89024	1-1/4"	4,500	1	85981*

+ See page 133 for drive arbor specifications. * Maximum density • Non-stock product, contact Customer Service for lead times and minimum order quantities.



Deburring the machined face of an aluminum component.



85733



85752



85981

CUP BRUSHES

MADE IN USA
WITH GLOBAL MATERIALS

Weiler also offers an assortment of Nylox® tools featuring traditional cup brush construction for deburring and finishing use in lighter duty applications. These brushing tools can be used on dedicated machines in automated processes or on low speed/high torque hand-held tools for manual applications.

APPLICATIONS

- Deburring and finishing complex or contoured parts

CUP BRUSHES - Crimped Round Silicon Carbide Filament

Diameter	Filament Dia./Grit	Arbor Hole	Trim Length	Max. RPM	Standard Pack	Item Number
2-3/4"	.022/320	1/4" Stem	1-1/4"	6,000	1	14401 •
	.035/180					14403 •
	.040/120					14404
3-1/2"	.035/180	5/8"-11	1-1/2"	12,000	1	14413
	.040/120					14414
5"	.040/120	5/8"-11	1-1/4"	9,000	1	14576
6"	.040/120	5/8"-11	1-1/4"	6,600	1	14516*
	.040/80					14506*

* With internal nut

• Non-stock product, contact Customer Service for lead times and minimum order quantities.



14413

NOTE
See adapters
on pages 132-133

COATED ABRASIVES

NON-WOVEN ABRASIVES

POWER BRUSHES

NYLOX BRUSHES

PACKAGED ITEMS

MAINTENANCE



Deburring internal bores of a cylinder head.

CUSTOMIZABLE CROSSHOLE DEBURRING SOLUTIONS

Replacement Bore-Rx Brush Heads and Reusable Bore-Rx Arbors

In high production applications, reusable arbors reduce manufacturing costs by allowing the use of inexpensive brush head replacements. Brush heads are made-to-order in diameters ranging from 7/8" to 1-1/2" with face widths of 1/4" to 1". They are available on 3/16" and 1/4" pins. The pin diameter is based on the application and determines brush density. To discuss specific requirements with a specialist call: 800-835.9999.



Replacement Head



Reusable Arbor 03993 •



Reusable Extension 03991 •

BORE-RX™ CROSSHOLE DEBURRING BRUSHES

MADE IN USA
WITH GLOBAL MATERIALS

These brushes are designed for automated applications in CNC machining centers and dedicated machines. They are ideal for removing burrs from internal edges and finishing bores. Since they eliminate off-hand deburring, they improve part-to-part consistency and reduce direct labor content. Bore-Rx brushes are available in sizes ranging from 7/8" to 4" and can be readily adapted into a machining center's tool changer using an end-mill holder or 3/8" collet.

Operating Parameters For Bore-Rx Brushes

Brush Diameter	Recommended RPM	Recommended Feed Rate
5/8" - 7/8"	3000	20"/min
1" - 1-1/2"	3000	20"/min
2" - 2-1/2"	2000	20"/min
3" - 4"	1500	20"/min

Tool Paths for Crosshole Deburring

An effective tool path for most crosshole deburring jobs is circular interpolation using the following guidelines to determine diameter of interpolation. The interpolation should be performed at a depth where the center of the brush face is at the center of the intersecting hole.

Diameter of Interpolation = Hole Dia. - 0.975 x Brush Dia.

Tool Paths for Bore Finishing

Nylox® brushes can be used to improve the surface finish of bores. The best tool path normally involves helically interpolating the bore. The above recommendations for speed, feed and diameter of interpolation are also valid for bore finishing. The use of coolant is highly recommended in order to achieve maximum surface finish improvement.



BORE-RX® BRUSHES - 3/8" Stem - Crimped Round Black Ceramic Filament

Diameter	Filament Dia./Grit	Face Width	Trim Length	Overall Length	Max. RPM	Standard Pack	Item Number
7/8"	.026"/120	3/4"	.160"	4-3/4"	8,000	1	17206
1"	.026"/120	3/4"	.215"	4-3/4"	8,000	1	17208
1-1/4"	.026"/120	3/4"	.345"	4-3/4"	8,000	1	17210
1-1/2"	.026"/120	1"	.475"	5"	8,000	1	17212
2"	.026"/120	1"	.535"	3-1/4"	6,000	1	17215
2-1/2"	.055"/80	1"	.765"	3-1/4"	6,000	1	17217
3"	.026"/120	1"	.560"		6,000	1	86150
	86151						
	86152						
4"	.026"/120	1"	1.040"	3-1/4"	6,000	1	86154
	.043"/120						86155
	.055"/80						86156

Note: All Bore-Rx brush stems have a 2" long flat for use in end mill holders. Alternatively, they can be mounted in 3/8" collets.

TUBE BRUSHES

MADE IN USA
WITH GLOBAL MATERIALS

Nylox® power tube brushes are ideal for internal deburring and finishing applications in tubular component parts, drilled and tapered holes, and machined bores and passages. These brushes are suitable for use in drill presses and manual and CNC machine tools. See page 114 for operating guidelines.

TUBE BRUSHES - Micro Abrasive - For ultra-fine deburring and finishing of small internal holes.



26904



26908



26915

Diameter	Length of Brush Part	Stem Diameter	For Hole Diameters		Overall Length	Standard Pack	Item Number
			Decimal	Fraction			
2000 Grit Aluminum Oxide Filament							
.030"	1/2"	.015	.031"	1/32"	4"	10	26900
.050"	1/2"	.022	.047"	3/64"	4"		26901
.075"	3/4"	.033	.063"	1/16"	4"		26902
.090"	3/4"	.041	.078"	5/64"	4"		26903
.105"	1"	.041	.094"	3/32"	4"		26904
.125"	1"	.064	.109"	7/64"	4"		26905
.135"	1"	.075	.125"	1/8"	4"		26906
600 Grit Aluminum Oxide Filament							
.165"	1"	.087	.156"	5/32"	5"	10	26907
.190"	1"	.087	.188"	3/16"	5"		26908
.260"	1"	.115	.250"	1/4"	5"		26909
.325"	1"	.115	.313"	5/16"	5"		26910
.385"	1"	.147	.375"	3/8"	5"		26911
.515"	1"	.194	.500"	1/2"	5"		26912
.640"	1"	.194	.625"	5/8"	5"		26913 •
.765"	1"	.212	.750"	3/4"	5"		26914 •
.890"	1"	.212	.875"	7/8"	5"		26915 •

• Non-stock product, contact Customer Service for lead times and minimum order quantities.

BURR-RX® TUBE BRUSHES - Crimped Black Ceramic Filament - 1/4" Cadmium Plated Stems

Nominal Diameter	Traditional Diameter	Metric Diameter	Filament Dia./Grit	Length of Brush Part	Stem Diameter	Overall Length	Standard Pack	Item Number
6mm	0.236"	6.00 mm	.026/120	1"	1/4"	3-1/2"	10	22602
1/4"	0.250"	6.35 mm	.026/120	1"	1/4"	3-1/2"	10	21757 •
7mm	0.276"	7.00 mm	.026/120	1"	1/4"	3-1/2"	10	22603
8mm	0.315"	8.00 mm	.026/120	1"	1/4"	3-1/2"	10	22604
9mm	0.354"	9.00 mm	.026/120	1"	1/4"	3-1/2"	10	22605
3/8"	0.375"	9.53 mm	.026/120	1"	1/4"	3-1/2"	10	21758
10mm	0.394"	10.00 mm	.026/120	1"	1/4"	3-1/2"	10	22606
11mm	0.433"	11.00 mm	.026/120	1"	1/4"	3-1/2"	10	22607
12mm	0.472"	12.00 mm	.026/120	1"	1/4"	3-1/2"	10	22608
1/2"	0.500"	12.70 mm	.026/120	1"	1/4"	3-1/2"	10	21759
14mm	0.551"	14.00 mm	.026/120	1"	1/4"	3-1/2"	10	22610
9/16"	0.563"	14.29 mm	.026/120	1"	1/4"	3-1/2"	10	21760 •
5/8"	0.625"	15.88 mm	.026/120	1"	1/4"	3-1/2"	10	21761
18mm	0.709"	18.00 mm	.026/120	1"	1/4"	3-1/2"	10	22614
3/4"	0.750"	19.05 mm	.026/120	1"	1/4"	3-1/2"	10	21762
20mm	0.787"	20.00 mm	.026/120	1"	1/4"	3-1/2"	10	22616
7/8"	0.875"	22.23 mm	.026/120	1"	1/4"	3-1/2"	10	21763
1"	1.000"	25.40 mm	.026/120	1"	1/4"	3-1/2"	10	21764
1-1/4"	1.250"	31.75 mm	.026/120	1"	1/4"	3-1/2"	10	21765 •

• Non-stock product, contact Customer Service for lead times and minimum order quantities.



Crosshole deburring an aluminum manifold.



21759

TUBE BRUSHES - Crimped Round Silicon Carbide Filament - Double Stem, Single Spiral

Diameter	Filament Dia./Grit	Length of Brush Part	Stem Diameter	Overall Length	Standard Pack	Item Number
1/4"	.022/320	2"	5/32"	5"	10	21126
3/8"	.022/320	2"	5/32"	5"	10	21128
1/2"	.022/320	2"	3/16"	5"	10	21130
	.040/80					21325
5/8"	.022/320	2"	7/32"	5"	10	21132
	.040/80					21326
11/16"	.022/320	2"	7/32"	5"	10	21133
3/4"	.022/320	2-1/2"	1/4"	5-1/2"	10	21134
	.040/80					21327
7/8"	.022/320	2-1/2"	1/4"	5-1/2"	10	21136
	.040/80					21976
1"	.022/320	2-1/2"	1/4"	5-1/2"	10	21138
	.040/80					21328
1-1/4"	.022/320	2-1/2"	1/4"	5-1/2"	10	21306
	.022/120					21304
	.035/180					21305
	.040/80					21329
1-1/2"	.022/320	2-1/2"	1/4"	5-1/2"	10	21309
	.035/180					21308
	.040/80					21330
1-3/4"	.040/80	2-1/2"	1/4"	5-1/2"	10	21311
	.035/180					21312
2"	.022/320	2-1/2"	1/4"	5-1/2"	10	21473
	.040/80					21345



21128



21138



21473

COATED ABRASIVES

NON-WOVEN ABRASIVES

POWER BRUSHES

NYLON BRUSHES

PACKAGED ITEMS

MAINTENANCE

FLAT SURFACE DEBURRING PRODUCTS

MADE IN
USA
WITH GLOBAL
MATERIALS

DISC BRUSHES

Manufactured using a tufted filament configuration and longer trim length for increased aggression, greater conformability and longer product life in comparison to monofilament disc brushes, which feature a distribution of short individual bristles.

Burr-Rx® disc brushes feature Weiler's advanced black ceramic grain filament, which delivers up to a 400% greater edge cutting action in comparison to traditional silicon carbide and aluminum oxide filaments for the fastest, most aggressive deburring action for minimum cycle times and maximum life.

All Burr-Rx disc brushes are manufactured using a new process that results in a very consistent, flat brush face in comparison to traditional construction, which utilizes a molded backing. The high dimensional precision of these tools means that the brushes are suitable for the most critical applications and perform more consistently from first part to last. In addition, the machined polymer backings are designed to mount directly onto a standard shell mill holder for convenient use in CNC machining centers.

APPLICATIONS

- Deburring flat surfaces on machined components
- Deburring face-milled castings or forgings
- Improving texture characteristics on machined or ground surfaces
- Blending tool marks after machining or grinding



Deburring a bearing cage in a CNC machining center.



Disc brush shown with shell mill holder

DISC BRUSHES

0.075" - 0.100" DEPTH OF INTERFERENCE

OPERATING SPEEDS - DISC BRUSHES



Diameter	RPM
1-3/4" & 2"	1,750 - 2,000
3"-4"	1,500 - 1,750
5" - 6"	1,250 - 1,500
8"	800 - 1,000
10"	700 - 800
12"	600 - 700
14"	500 - 600

FEED RATE RECOMMENDATIONS

Feed rate is determined by the amount of deburring, edge radiusing or surface finishing required, and the type of material that is being processed. It is generally application specific. Slower feeds result in a more aggressive brushing action. Based on the brushing action desired for a specific application, the feed rate can be increased or decreased.

Material	SiC and AO Grain Feed Rate	Burr-Rx Grain Feed Rate
Non-Ferrous	50 in./min.	80 in./min.
Cast Iron	30 in./min.	60 in./min.
Mild Steel and Ductile Iron	25 in./min.	50 in./min.
Stainless and Alloy Steels	15 in./min.	30 in./min.
Titanium and High Nickel Alloys	10 in./min.	30 in./min.

BURR-RX® SHELL MILL HOLDER DISC BRUSHES - Crimped Black Ceramic Filament

Compatible with 3" shell mill holders.

Diameter	Filament Dia./Grit	Arbor Hole	Trim Length	Max. RPM	Standard Pack	Item Number
Round Filament						
4"	.026/120	1-1/4"	1-1/2"	2,500	1	86112
	.043/120					86113
	.043/120					86204*
	.055/80					86114*
6"	.026/120	1-1/4"	1-1/2"	2,500	1	86115
	.043/120					86116
	.055/80					86117*
	.026/120					1-1/4"
.043/120	86142					
.055/80	86143*					
.026/120	1-1/4"	1-1/2"	2,000	1	86125 •	
.043/120					86121	
.055/80					86122*	
Rectangular Filament						
4"	80	1-1/4"	1-1/2"	2,500	1	86167*
6"	80	1-1/4"	1-1/2"	2,500	1	86198*
8"	80	1-1/4"	1-1/2"	2,500	1	86199* •

* Maximum Density

• Non-stock product, contact Customer Service for lead times and minimum order quantities.



86112



86143

COMPOSITE HUB DISC BRUSHES - Silicon Carbide Filament

Diameter	Filament Dia./Grit	Arbor Hole	Drive Arbor Recommendation	Trim Length	Max. RPM	Standard Pack	Item Number
Crimped Round Filament							
3"	.035/180	7/8"	07700	1-1/2"	2,500	1	85776
	.040/120						85778
3-1/2"	.022/320	7/8"	07700	1-1/2"	2,500	1	85792
	.035/180						85794
	.040/80						85798
4"	.022/320	7/8"	07700	1-1/2"	2,500	1	85812
	.035/180						85814
	.040/120						85816
	.040/80						85818
5"	.035/180	7/8"	07700	1-1/2"	2,500	1	85832
	.040/80						85836 •
6"	.035/180	7/8"	07701	1-1/2"	2,000	1	85850
	.040/120						85852
	.040/80						85854
8"	.035/180	7/8"	07702	1-1/2"	2,000	1	85908
	.040/120						85912 •
	.040/80						85914 •
10"	.040/120	7/8"	07703	1-1/2"	1,750	1	85930
	.040/80						85932 •
12"	.035/180	7/8"	07703	1-1/2"	1,750	1	85946 •
	.040/120						85948 •
Rectangular Filament							
3"	120	7/8"	07700	1-1/2"	2,500	1	85786
	80						85788
3-1/2"	320	7/8"	07700	1-1/2"	2,500	1	85800 •
	80						85806
4"	180	7/8"	07700	1-1/2"	2,500	1	85822 •
	120						85824
	80						85826
	80						85995 •
	80						85900* •
5"	120	7/8"	07700	1-1/2"	2,500	1	85842 •
	80						85844
	80						85978 •
	80						85978 •
6"	120	7/8"	07701	1-1/2"	2,000	1	85860
	80		07701				85862
	80		07715				85996 •
	80		07715				85901* • •
	80		07715				85920 •
8"	120	7/8"	07702	1-1/2"	2,000	1	85922
	80						85922
9"	80	7/8"	07702	1-1/2"	1,750	1	85997 •
10"	120	7/8"	07703	1-1/2"	1,750	1	85938 •
	80						85940 •

* Banded for extra aggression

• Maximum density

• Non-stock product, contact Customer Service for lead times and minimum order quantities.



Deburring the edges of an aluminum engine cover.



85852



85786

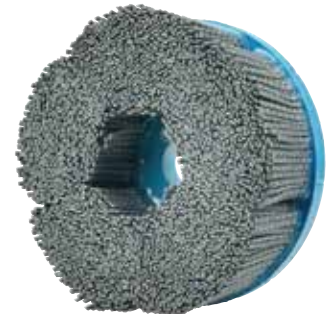

85997

COATED ABRASIVES

NON-WOVEN ABRASIVES

POWER BRUSHES

NYLON BRUSHES

Arbor & Drive Hole Specifications for Composite Hub Disc Brushes

Brush Diameter	Arbor Hole Diameter	Drive Holes
3"-5", 6" Max. Density	7/8"	(2) 1/4" dia. on a 1-1/4" dia. bolt circle
6"	7/8"	(3) 1/4" dia. on a 3" dia. bolt circle
8"	7/8"	(4) 1/4" dia. on a 3" dia. bolt circle
10"	7/8"	(4) 1/4" dia. on a 1.625" dia. bolt circle
12"	7/8"	(4) 1/4" dia. on a 1.625" dia. bolt circle

NOTE

See adapters on pages 132-133

85997

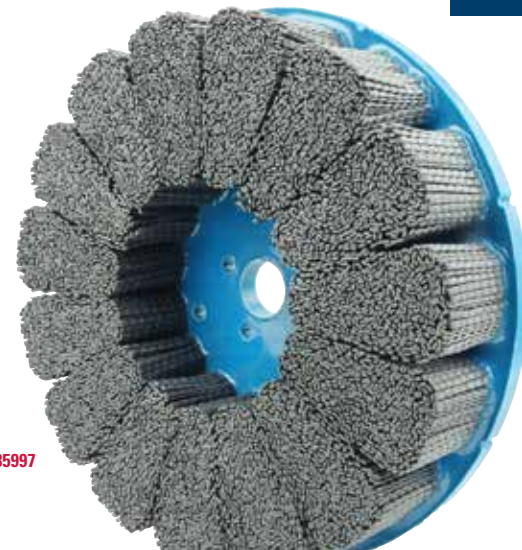



Removing burrs and breaking sharp edges on a transmission component.

MINI DISC BRUSHES

MADE IN USA
WITH GLOBAL MATERIALS

Featuring a precision machined aluminum cup, Weiler's mini-disc brushes are designed to be the most cost-effective media for applications requiring a smaller brushing tool.

APPLICATIONS

- Deburring flat surfaces on machined components
- Improving texture characteristics on machined or ground surfaces
- Deburring face-milled castings or forgings
- Blending tool marks after machining or grinding

BURR-RX® MINI DISC BRUSHES - Maximum Density - Crimped Black Ceramic Filament



85733



85752



85981

Diameter	Filament Dia./Grit	Arbor Hole	Drive Arbor + Recommendation	Trim Length	Max. RPM	Standard Pack	Item Number
Round Filament							
2"	.026/120	3/8"	89029 or 89033	1-1/4"	4,500	2	86106
	.035/80					1	85738
	.043/120					2	86107
	.055/80					2	85733
3"	.026/120	3/8"	89029 or 89033	1-1/4"	4,500	1	86109
	.035/80						86013
	.043/120						86110
	.055/80						86111
Rectangular Filament							
2"	80	3/8"	89029 or 89033	1-1/4"	4,500	1	85736
3"	80	3/8"	89029 or 89033	1-1/4"	4,500	1	86014

+ See page 133 for drive arbor specifications.

MINI DISC BRUSHES - Silicon Carbide Filament

Diameter	Filament Dia./Grit	Arbor Hole	Drive Arbor + Recommendation	Trim Length	Max. RPM	Standard Pack	Item Number
Round Filament							
1-3/4"	.035/180	5/8"	89023 or 89024	1-1/4"	6,000	2	85753
	.022/120						85751 •
	.040/80						85750
Rectangular Filament							
1-3/4"	80	5/8"	89023 or 89024	1-1/4"	6,000	2	85752
2"	80	3/8"	89023 or 89024	1-1/4"	4,500	2	85773*
3"	80	3/8"	89023 or 89024	1-1/4"	4,500	1	85981*

+ See page 133 for drive arbor specifications. * Maximum density • Non-stock product, contact Customer Service for lead times and minimum order quantities.



"I have had no issues with any Weiler products. They are reliable. They make a good product. I don't think you could ask for anything else."

- Richard Carpenter, Nuclear Industry Worker

END BRUSHES

MADE IN
USA
WITH GLOBAL
MATERIALS

Featuring an integral stem for convenient mounting into a tool holder or collet, Nylox® end brushes and miniature end brushes are suitable for addressing recesses and internal features, or delivering a targeted brushing action to a specific area on a part.

APPLICATIONS

- Deburring small recessed areas and internal part features
- Finishing slots and recessed surfaces on machined parts



Blending tool marks on a hydraulic component.

BURR-RX® END BRUSHES - Banded - Crimped Round Black Ceramic Filament - Mounted on 1/4" Stems

Diameter	Filament Dia./Grit	Trim Length*	Recommended RPM	Overall Length	Max. RPM	Standard Pack	Item Number
3/8"	.026/120	1/4"	4,500 - 5,000	2-3/8"	10,000	10	86098
	.043/120						86099
1/2"	.026/120	1/4"	4,500 - 5,000	2-7/16"	10,000	10	86100
	.043/120						86101
3/4"	.026/120	1/4"	4,200 - 4,500	2-7/16"	10,000	10	86102
	.043/120						86103
1"	.026/120	1/4"	3,500 - 3,800	2-5/8"	10,000	10	86104
	.043/120						86105
	.055/80						86097

* Trim length from bands



86104

END BRUSHES - Banded - Crimped Round Silicon Carbide Filament - Mounted on 1/4" Stems

Diameter	Filament Dia./Grit	Trim Length*	Overall Length	Max. RPM	Standard Pack	Item Number
1/2"	.022/320	3/8"	2-9/16"	10,000	10	11160
	.035/180					11161
	.040/120					11162
3/4"	.035/180	3/8"	2-7/16"	10,000	10	11165
	.040/120					11166
1"	.035/180	3/8"	2-11/16"	10,000	10	11169
	.040/120					11170

* Trim length from bands



11166

END BRUSHES - Crimped Round Silicon Carbide Filament - Mounted on 1/4" Stems

Diameter	Filament Dia./Grit	Trim Length	Overall Length	Max. RPM	Standard Pack	Item Number
1/2"	.022/320	7/8"	2-9/16"	10,000	10	10172
	.035/180					10173
	.040/120					10174
3/4"	.022/320	7/8"	1-1/2"	10,000	10	10152
	.035/180					10153
	.040/120					10154
1"	.022/320	7/8"	2-3/4"	10,000	10	10155
	.035/180					10156
	.040/120					10157



10154

MINIATURE END BRUSHES - Plastic Ferrule - Crimped Round Silicon Carbide Filament

Mounted on 1/8" stems

Diameter	Filament Dia./Grit	Trim Length	Overall Length	Max. RPM	Standard Pack	Item Number
3/16"	.018/500	1/4"	1-7/8"	37,000	144	26136
1/4"	.018/500	3/8"	2-1/8"	37,000	144	26138
5/16"	.018/500	9/16"	2-11/32"	25,000	144	26146



26136

COATED ABRASIVES

NON-WOVEN ABRASIVES

POWER BRUSHES

NYLOX BRUSHES

PACKAGED ITEMS

MAINTENANCE

TARGETED FEATURE DEBURRING PRODUCTS

MADE IN
USA
WITH GLOBAL
MATERIALS



Deburring a vane section for a jet engine.

WHEEL BRUSHES

Weiler's Nylox® abrasive nylon wheel brushes featuring composite metal hub and composite hub construction are manufactured using a molded polymer material to retain the filaments. In comparison to traditional metal hub construction that folds the fill material around an internal retaining ring or wrap wire, these techniques result in a significant increase in fill density and elimination of filament breakage, offering the lowest cost-of-use and greatest consistency of performance in production applications.

Weiler's composite metal hub wheels marry the high density and superior filament retention of composite hub wheels with the dimensional stability and shock resistance of metal hub construction, and they feature 2" arbor holes, which allows for convenient mounting on many pieces of equipment.

Burr-Rx® wheels feature Weiler's advanced black ceramic grain filament, which delivers up to a 400% greater edge cutting action in comparison to traditional silicon carbide and aluminum oxide filaments for the fastest, most aggressive deburring action to minimize cycle times and maximize media life.

APPLICATIONS

- Precision deburring of component parts after machining or grinding
- Improving texture characteristics on machined or ground surfaces
- Honing cutting tools and generating specific edge profiles and radii
- Light duty cleaning and finishing of metals; light sanding of woods and composites

BURR-RX® CRIMPED FILAMENT WHEELS

Composite Metal Hub* - Crimped Round Black Ceramic Filament

Diameter	Filament Dia./Grit	Arbor Hole	Face Width	Trim Length	Thickness At Face Plates	Max. RPM	Standard Pack	Item Number
6"	.026/120	2"	3/4"	1"	15/16"	4,000	1	86123
	.035/80							86181
	.043/120							86124
	.055/80							86120
8"	.026/120	2"	7/8"	2"	15/16"	4,000	1	86126
	.043/120							86127
	.055/80							86128
10"	.026/120	2"★	1-1/8"	2"	7/8"	1,800	2	86129
	.035/80							86182 •
	.043/120							86130
	.055/80							86131
12"	.026/120	2"★	1-1/4"	3"	7/8"	1,800	2	86132
	.043/120							86133
	.055/80							86134
14"	.026/120	2"★	1"	1-3/4"	3/4"	1,800	2	86135
	.035/80							86108
	.043/120							86136
	.055/80							86137
14"	.026/120	2"★	1-1/4"	4"	7/8"	1,800	2	86138 •
	.043/120							86139
	.055/80							86140

*Patent Pending

★ 1/2" x 1/4" Double Keyway

• Non-stock product, contact Customer Service for lead times and minimum order quantities.

BURR-RX CRIMPED FILAMENT WHEELS

Composite Hub - Crimped Round Black Ceramic Filament

O.D. x I.D.	Filament Dia./Grit	Face Width	Trim Length	Thickness At Face Plates	Max. RPM	Standard Pack	Item Number
8" x 3-1/4"	.043/120	1"	1-5/16"	13/16"	1,800	2	83394 •
14" x 7-1/4"	.026/120	1"	2-3/4"	15/16"	1,800	2	84926 •
	.043/120						84941 •
	.035/80						84925 •
	.055/80						83405

• Non-stock product, contact Customer Service for lead times and minimum order quantities.



CRIMPED FILAMENT WHEELS - Composite Metal Hub* - Crimped Round Silicon Carbide Filament

Diameter	Filament Dia./Grit	Arbor Hole	Face Width	Trim Length	Thickness Through Arbor	Max. RPM	Standard Pack	Item Number
6"	.018/500	2"	1"	1-1/4"	1-1/16"	4,000	1	83000
	.022/320							83010
	.022/120							83011
	.035/180							83030
	.040/120							83040
	.040/80							83050
	.060/46							83070
8"	.018/500	2"	1"	2-1/4"	3/4"	4,000	2	83100
	.022/320							83110
	.022/120							83111
	.035/180							83130
	.040/120							83140
	.040/80							83150
	10"							.022/320
.035/180		83514 •						
.040/120		83515 •						
.040/80		83516 •						
12"	.022/320	2"★	1-1/4"	3"	7/8"	1,800	2	83715 •
	.035/180							83716 •
	.040/120							83717 •
	.040/80							83718 •

*Patent Pending

★ 1/2" x 1/4" Double Keyway

• Non-stock product, contact Customer Service for lead times and minimum order quantities.



Removing burrs from an aluminum heat sink.

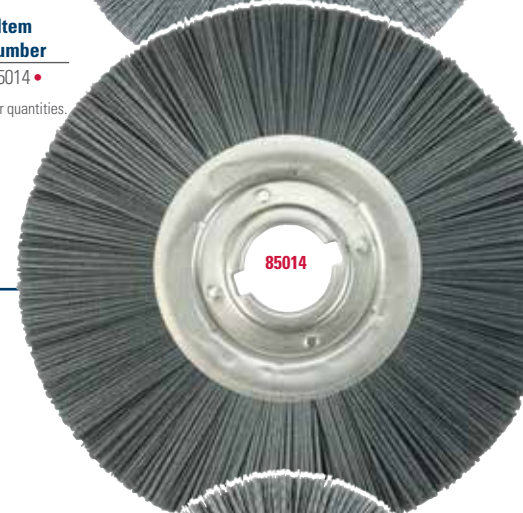

COATED ABRASIVES

RECTANGULAR FILAMENT WHEEL - Composite Metal Hub* - Straight Silicon Carbide Filament

Diameter	Grit Size	Arbor Hole	Face Width	Trim Length	Thickness Through Arbor	Max. RPM	Standard Pack	Item Number
12"	80	2"★	1-1/4"	3"	7/8"	1,800	2	85014 •

*Patent Pending

★ 1/2" x 1/4" Double Keyway

• Non-stock product, contact Customer Service for lead times and minimum order quantities.

METAL HUB BASIC SECTIONS

MADE IN USA
WITH GLOBAL MATERIALS

CRIMPED FILAMENT BASIC SECTIONS - Metal Hub - Crimped Round Silicon Carbide Filament

For light-duty deburring and finishing in applications such as low-volume manual deburring or general use in a tool room or shop.

O.D. x I.D.	Filament Dia./Grit	Face Width	Trim Length	Thickness Through Arbor	Max. RPM	Standard Pack	Item Number
6" x 2"	.022/320	5/8"	1-1/2"	9/16"	6,000	2	20600
	.035/180						20610
	.040/120						20620
8" x 2"	.022/320	5/8"	2-1/2"	9/16"	5,000	2	20630 •
	.040/120						20650
10" x 3-1/4"	.035/180	9/16"	2-7/8"	17/32"	4,500	2	20661 •
14" x 5-1/4"	.035/180	9/16"	3-7/8"	9/16"	3,000	2	20730 •

• Non-stock product, contact Customer Service for lead times and minimum order quantities.

NOTE
See adapters
on pages 132-133



Deburring the tip of a turbine blade.

NARROW FACE WHEELS

MADE IN
USA
WITH GLOBAL
MATERIALS

BURR-RX® HEAVY-DUTY NARROW FACE WHEELS - Metal Hub - Crimped Round Black Ceramic Filament

Diameter	Filament Dia./Grit	Arbor Hole	Face Width	Trim Length	Thickness Through Arbor	Max. RPM	Standard Pack	Item Number
3"	.026/120	5/8"-1/2"	9/16"	1/2"	7/16"	6,000	2	31240
	.035/80							31241
4"	.026/120	5/8"-1/2"	5/8"	1"	7/16"	6,000	2	31110
	.035/80							31270
	.043/120							31280
	.055/80							31290



31110



86165

BURR-RX NARROW FACE WHEELS - Metal Hub - Crimped Round Black Ceramic Filament

Diameter	Filament Dia./Grit	Arbor Hole	Face Width	Trim Length	Thickness Through Arbor	Max. RPM	Standard Pack	Item Number
3"	.035/80	1/2"-3/8"	3/8"	1/2"	7/16"	6,000	2	31102
	.043/120							31101
4"	.026/120	1/2"-3/8"	1/2"	7/8"	7/16"	6,000	2	86165
	.035/80							31103
	.043/120							31100
	.055/80							31105
6"	.026/120	5/8"-1/2"	5/8"	7/8"	11/16"	4,500	2	31134
	.043/120							31135
	.035/80							31136
	.055/80							31137

HEAVY-DUTY NARROW FACE WHEELS - Metal Hub - Crimped Round Silicon Carbide Filament

Diameter	Filament Dia./Grit	Arbor Hole	Face Width	Trim Length	Thickness Through Arbor	Max. RPM	Standard Pack	Item Number
3"	.040/80	5/8"-1/2"	9/16"	1/2"	7/16"	6,000	2	31245 •
4"	.022/320	5/8"-1/2"	5/8"	1"	7/16"	6,000	2	31255 •
	.035/180							31265
	.040/120							31275
	.040/80							31285

• Non-stock product, contact Customer Service for lead times and minimum order quantities.



31285

NARROW FACE WHEELS - Metal Hub - Crimped Round Silicon Carbide Filament

Diameter	Filament Dia./Grit	Arbor Hole	Face Width	Trim Length	Thickness Through Arbor	Max. RPM	Standard Pack	Item Number
3"	.022/320	1/2"-3/8"	3/8"	1/2"	7/16"	6,000	2	31074
	.035/180							31084
	.040/120							31094
	.022/320							31104
4"	.035/180	1/2"-3/8"	1/2"	7/8"	7/16"	6,000	2	31114
	.040/120							31124
	.022/320							31121
6"	.035/180	5/8"-1/2"	5/8"	7/8"	11/16"	4,500	1	31122
	.040/120							31123



31124

APPLICATION ENGINEERED WHEELS

CRIMPED FILAMENT WHEELS - Composite Hub - Crimped Round Silicon Carbide Filament

O.D. x I.D.	Filament Dia./Grit	Face Width	Trim Length	Thickness Through Arbor	Max. RPM	Standard Pack	Item Number
6" x 2"	.040/80	1/2"	1-1/4"	9/16"	3,600	1	83116 •
8" x 2"*	.040/120	7/8"	2-1/8"	13/16"	3,600	2	83190 • 83180 •
8" x 3-1/4"	.040/80	1"	1-5/16"	13/16"	1,800	2	83393 •
10" x 2"	.018/500 .022/320 .035/180 .040/120 .040/80	1"	3"	1-1/16"	3,600	2	83300 83310 • 83330 83340 83350
10" x 3-1/4"	.035/180 .040/120 .040/80	1"	2-5/16"	13/16"	1,800	2	83430 • 83440 83450
10" x 5-1/4"	.040/80	1"	1-5/8"	15/16"	1,800	2	83550
12" x 3-1/4"	.035/180 .040/120	1-1/8"	3-5/16"	13/16"	1,800	2	83630 • 83640 •
12" x 4-1/4"	.022/320 .035/180 .040/120 .040/80	1"	3-1/8"	15/16"	1,800	2	84710 • 84730 • 84740 • 84750 •
12" x 5-1/4"	.040/120 .040/80	1-1/8"	2-3/4"	15/16"	1,800	2	83740 • 83750
12" x 5-1/4"-2"*	.022/320	1-1/8"	2-3/4"	1-1/16"	1,800	2	85156 ••
14" x 5-1/4"	.022/320 .035/180 .040/120 .040/80	1-1/8"	3-3/4"	15/16"	1,800	2	83910 83930 83940 83950
14" x 5-1/4"-2"*	.022/320 .040/80	1-1/8"	3-3/4"	1-1/16"	1,800	2	85150 •• 85153 ••
20" x 12"	.035/180	1-1/4"	3-1/4"	1-1/16"	1,000	1	85440 •

• Same density as our standard 5-1/4" I.D. brushes, but requires no adapters for mounting on a 2" diameter shaft.
* 1/2" x 1/4" Double Keyway

• Non-stock product, contact Customer Service for lead times and minimum order quantities.



Deburring a camshaft with a Nylox wheel.



RECTANGULAR FILAMENT WHEEL - Composite Hub - Straight Silicon Carbide Filament

O.D. x I.D.	Grit Size	Face Width	Trim Length	Thickness Through Arbor	Max. RPM	Standard Pack	Item Number
14" x 5-1/4"	120	1-1/8"	3-3/4"	1-1/16"	1,800	2	84640

Other diameters and grit sizes available upon request.

DIAMOND FILAMENT WHEEL BRUSHES

MADE IN
USA
WITH GLOBAL
MATERIALS

Weiler's diamond filament wheels are ideal for producing edge radii on hard materials such as diamond, CBN, ceramic and glass. Our wheel brushes are made-to-order in a wide range of diameters and thicknesses. Additional configurations are available such as; tube brushes, composite hub disc brushes and end brushes. Other sizes and pricing are available on request. Please contact Customer Service at 800-835-9999.

DIAMOND FILAMENT WHEELS - Composite Hub - Round Diamond Filament

O.D. x I.D.	Filament Dia./Grit	Face Width	Trim Length	Thickness Through Arbor	Max. RPM	Standard Pack	Item Number
6" x 2"	.024/200 .014/600 .012/1000	5/16"	1-1/4"	1/4"	3,600	1	83002 • 83003 • 83004 •
8" x 2"	.024/200 .014/600 .012/1000	5/16"	2-1/4"	1/4"	3,600	1	83005 • 83006 • 83007 •

• Non-stock product, contact Customer Service for lead times and minimum order quantities.

NOTE
See adapters
on pages 132-133

ADAPTERS AND DRIVE ARBORS



03809



03923



03944



03403

NOTE

The adapters and drive arbors listed on this page are for use with small diameter wheel brushes only; do not attempt to use them with cutting or grinding wheels, buffing wheels, or any type of abrasive wheel or disc.

METAL ADAPTERS - Reusable - Used in pairs and priced per pair.

Diameter	Arbor Hole Size	Used With	Standard Pack	Item Number
2"	1/2"	All 2" I.D. Wheels	1	03809
	5/8"			03810
	3/4"			03811
	7/8"			03824
	1"			03812
	1-1/4"			03813
3-1/4"	1-1/2"	3-1/4" I.D. Wheels (When mounting only one wheel)	1	03814
	3/4"			03910 •
	7/8"			03911 •
	1"			03912 •
	1-1/4"			03913 •
5-1/4"	2"	5-1/4" I.D. Wheels (When mounting only one wheel)	1	03915 •
	3/4"			03920 •
	7/8"			03921 •
	1"			03922 •
	1-1/4"			03923 •
	2"			03925

• Non-stock product, contact Customer Service for lead times and minimum order quantities.

STEEL FLANGES - Reusable - Used on the ends of a gang mount. Used in pairs and priced per pair.

Must be used in conjunction with Pressboard Adapters in chart below.

Flange O.D.	Arbor Hole Size	Used With	Standard Pack	Item Number
5-5/8"	3/4"	3-1/4" & 4-1/4" I.D. Wheels	1	03931 •
	1"			03933 •
	1-1/4"			03934 •
	2"			03936 •
6-1/2"	1-1/4"	5-1/4" I.D. Wheels	1	03944 •
	1-1/2"			03945 •
	2"			03946 •
8-3/4"	1-1/4"	7-1/4" I.D. Wheels	1	03954 •
	1-1/2"			03955 •
	2"			03956 •

• Non-stock product, contact Customer Service for lead times and minimum order quantities.

PRESSBOARD ADAPTERS - Used for centering 10", 12" and 14" Nylox® Wheels when gang mounting.

Must be used in conjunction with Steel Flanges in chart above.

Brush I.D.	Arbor Hole Size	Standard Pack	Item Number
3-1/4"	3/4"	1	03890 •
	1"		03892 •
	1-1/4"		03893 •
	2"		03895 •
4-1/4"	3/4"	1	03960 •
	1-1/4"		03963 •
	2"		03965 •
5-1/4"	1-1/4"	1	03403 •
	1-1/2"		03404 •
	2"		03405 •
7-1/4"	1-1/4"	1	03973 •
	1-1/2"		03974 •
	2"		03975 •

• Non-stock product, contact Customer Service for lead times and minimum order quantities.



83999

*Fubricut*TM Lubricant

Prevents Smearing.
Improves the Finish.
Lowers Costs.



1. Turn off machine.



2. Slowly rotate wheel by hand.



3. While rotating, direct a light spray of Lubricut into the wheel face.

Use with Nylox® wheels operating above the recommended surface speed. Directing a light spray of Lubricut into the face of the wheel permits the wheel to be operated at higher surface speeds and up to twice the normal load without smearing - while improving the finish.

Description	Ounces	Standard Pack	Item Number
Lubricut Lubricant	8	1	83999

PLASTIC ADAPTERS

Fixed Arbor Hole Size	Adapted Arbor Hole Size	Used With	Standard Pack	Item Number
1/2"	1/4"	Small Dia. Wheels	10	04400
1/2"	3/8"	Small Dia. Wheels	10	04401
5/8"	1/2"	Small Dia. Wheels	10	04402



04401

04402

MINIATURE & BURR-RX® DISC BRUSH DRIVE ARBORS - Includes drive arbor, set screw and hex key.

For Brush Diameter	Stem Diameter	Stem Length	Max. RPM	Standard Pack	Item Number
1-3/4"	1/4"	1-3/4"	6,000	1	89023*
1-3/4"	3/8"	1-3/4"	6,000	1	89024*
2"-3"	1/2"	1-3/4"	6,000	1	89029*

* For use with Burr-Rx Mini Disc brushes only. Products supplied with set screw and wrench.



89023

MINIATURE & BURR-RX DISC BRUSH DRIVE ARBORS - Includes drive arbor, set screw and hex key. Recommended for operations in which brush rotation alternates between forward and reverse.

For Brush Diameter	Stem Diameter	Stem Length	Max. RPM	Standard Pack	Item Number
2"-3"	1/2"	1-3/4"	6,000	1	89033*

* For use with Burr-Rx Mini Disc brushes only. Products supplied with set screw and wrench.



89033

DISC BRUSH FLOW-THROUGH DRIVE ARBORS

Mounts Weiler disc brushes to any type of milling machine or CNC machine.

Fits	Arbor Hole	Drive Studs	Bolt Circle	Plate O.D.	Shaft Dia.	Stem Length	Std. Pack	Item Number
3", 4" and 5" Disc Brushes	7/8"	2	1-1/4"	2-7/8"	3/4"	2-3/4"	1	07700
6" Std. Tuft Disc Brushes NOT Max. Density	7/8"	3	3"	5-7/8"	3/4"	2-1/2"	1	07701
6" Max. Density Disc Brushes, also 5" Std. Tuft	7/8"	2	1-1/4"	4-7/8"	3/4"	2-1/2"	1	07715
8" and 9" Disc Brushes	7/8"	4	3"	7-7/8"	3/4"	2-1/2"	1	07702
10" and 12" Disc Brushes	7/8"	4	1-5/8"	9-7/8"	3/4"	2-1/2"	1	07703 •
Replacement kit includes: (1) 1/2"-13 locking flow-through bolt & (1) Belleville spring washer								07718 •

• Non-stock product, contact Customer Service for lead times and minimum order quantities.



07700



07718

NOTE

- Do not adapt a wheel brush for use on a shaft diameter less than that specified by ANSI B165.1 or exceed the maximum wheel diameter specified for a drive arbor.
- Never mount a drive arbor onto a tool that operates above the maximum RPM rating of either the arbor or the brush (whichever may be lower) and be sure that the stem of the arbor is properly secured in the collet or chuck before use.

WHY WEILER

BONDED ABRASIVES

COATED ABRASIVES

NON-WOVEN ABRASIVES

POWER BRUSHES

NYLON BRUSHES

PACKAGED ITEMS

MAINTENANCE

FME AREA PRODUCT SOLUTIONS



Removing gasket material from a pipe flange.

In nuclear power plants, Foreign Material Exclusion (FME) programs may limit or even exclude the use of wire brushes in some areas during the performance of routine maintenance, repair or shut-down activities. Weiler has developed a FME-compliant tooling system to address the needs of plant operators and maintenance contractors working in these facilities as well as other industries where the potential introduction of broken wire filaments may be of concern. Weiler's FME Solutions program is a complete system consisting of non-wire brushing tools designed to perform a broad range of surface cleaning and preparation applications.

BLACK NYLOX® CERAMIC BRUSHES - The engineered ceramic grain in Weiler's Black Nylox filament is up to 400% more aggressive than the silicon carbide and aluminum oxide grain in other abrasive filaments, making it much more effective in surface cleaning applications. The efficient cutting action of the Black Nylox filament also generates less heat and makes it much more resistant to "smearing" than traditional nylon abrasive filaments.



31112

NARROW FACE WHEELS - Crimped Ceramic Filament
Used on edge for weld prep and cold weld cleaning.

Diameter	Filament Dia./Grit	Face Width	Arbor Hole	Max. RPM	Standard Pack	Item Number
4"	.055/80	1/2"	5/8"-11 Nut	4,800	5	31112 •
4"	.043/120	1/2"	5/8"-11 Nut	4,800	5	31111 •

• Non-stock product, contact Customer Service for lead times and minimum order quantities.



86160

CUP BRUSH - Rectangular Ceramic Filament
Used on its face for heavy-duty cleaning of broad surfaces.

Diameter	Filament Dia./Grit	Arbor Hole	Max. RPM	Standard Pack	Item Number
4"	.049 x .098 - 80 Grit	5/8"-11 Nut	4,800	1	86160 •

• Non-stock product, contact Customer Service for lead times and minimum order quantities.



86148

END BRUSH - Crimped Ceramic Filament - 1/4" Stem
For spot-facing or cleaning in tight areas.

Diameter	Filament Dia./Grit	Trim Length	Overall Length	Max. RPM	Standard Pack	Item Number
1"	.055/80	1/4"	3-3/32"	4,800	10	86148 •

• Non-stock product, contact Customer Service for lead times and minimum order quantities.



86159

CONTROLLED FLARE END BRUSH - Crimped Ceramic Filament - 1/4" Stem
For cleaning corners and tight areas.

Diameter	Filament Dia./Grit	Trim Length	Overall Length	Max. RPM	Standard Pack	Item Number
1"	.035/80	1-1/8"	2-1/2"	4,800	10	86159 •

• Non-stock product, contact Customer Service for lead times and minimum order quantities.



86171

CONFLEX BRUSHES - Crimped Ceramic Filament - 1/4" Stem
For O.D. and I.D. cleaning in confined areas.

Diameter	Filament Dia./Grit	Face Width	Trim Length	Max. RPM	Standard Pack	Item Number
3"	.043/120	1"	15/16"	4,800	10	86171 •
3"	.055/80	1"	15/16"	4,800	10	86172 •

• Non-stock product, contact Customer Service for lead times and minimum order quantities.



44144



95016

HAND SCRATCH BRUSHES - Crimped Ceramic Filament - For general purpose, light-duty cleaning.

Overall Length	Block Type	Brush Part	Grit Size	Trim Length	Standard Pack	Item Number
10"	Wood	5"	80	3/4"	12	44144 •
8-3/4"	Wood	2 x 9 Rows	120	5/8"	36	95016 •

• Non-stock product, contact Customer Service for lead times and minimum order quantities.

NOTE

Nylon abrasive filament brushes require a lower operating RPM than most other power tool accessories and they cannot be used effectively on standard grinders.

WE VENDING READY

WHAT YOU NEED. WHEN YOU NEED IT.

We understand that a successful vending program requires products that fit into a machine without hassle and dispense properly, every time. Weiler now offers single pack quantities of vending-ready products. Our packaging eliminates the need to re-pack products, which can be both expensive and time consuming.

In addition to single packs, Weiler's products are also available in small intermediate pack quantities for easy refill. This minimizes the handling from your storage location all the way to the end-user. Our products come the way you need them, ready to load into vending machines.

QUALITY:

The same high performance Weiler products you know and trust now available for vending.

PROVEN:

Our Weiler vending products are guaranteed to work within all Helix-coil vending machines.

CONVENIENT:

We package and ship in easily refillable quantities, reducing your costs.

RELIABLE:

All vending products guaranteed in-stock for quick, reliable shipping anywhere at any time.



Our vending program drives cost out of the supply chain for our business partners by simplifying the vending process.



13106V

P **STANDARD TWIST WHEELS** Provide heavy-duty brushing action on somewhat irregular surfaces.



Dia.	Wire Size	Arbor Hole	No. of Knots	Face Width	Trim Length	Max. RPM	Intermediate Pack	Item Number	
								Steel	Stainless
3"	.014	1/2"-3/8"	20	3/8"	5/8"	25,000	5	08014V •	08264V •
4"	.014	5/8"-11 UNC	24	1/2"	7/8"	20,000	5	13106V •	13113V •
	.020							13120V	—

• Non-stock product, contact Customer Service for lead times and minimum order quantities.
BOLD BLACK ITEM numbers indicate color-coded brushes for easy identification.

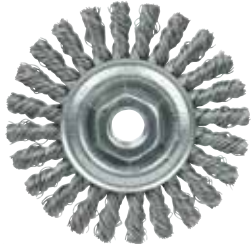

13266V

P **CABLE TWIST WHEELS** Provide heavy-duty brushing action on relatively smooth surfaces.



Dia.	Wire Size	Arbor Hole	No. of Knots	Face Width	Trim Length	Max. RPM	Intermediate Pack	Item Number	
								Steel	Stainless
4"	.020	5/8"-11 UNC	24	1/4"	7/8"	20,000	5	13266V	08534V •
		1/2"-3/8"						—	

• Non-stock product, contact Customer Service for lead times and minimum order quantities.



13138V

P **ROUGHNECK® STRINGER BEAD WHEELS** - The go to for high-performance weld cleaning.



Dia.	Wire Size	Arbor Hole	No. of Knots	Face Width	Trim Length	Max. RPM	Intermediate Pack	Item Number	
								Steel	Stainless
Root Pass Brushes									
4"	.020	5/8"-11 UNC	32	3/16"	7/8"	20,000	5	13131V •	13138V •
4-1/2"	.020	5/8"-11 UNC	38	3/16"	13/16"	12,500	5	13232V	—
5"	.020	5/8"-11 UNC	38	3/16"	7/8"	12,500	5	08756V •	08806V
6"	.020	5/8"-11 UNC	48	3/16"	1-1/8"	12,500	1	08766V †	—
								09400V	—
6"	.020	5/8"-11 UNC	56	3/16"	1-1/8"	9,000	1	09000V	—
Filler Pass Brushes									
6"	.023	5/8"-11 UNC	24	1/2"	1-3/8"	12,500	1	08776V	—

† Light-duty

• Non-stock product, contact Customer Service for lead times and minimum order quantities.
BOLD BLACK ITEM numbers indicate color-coded brushes for easy identification.



08776V



17687V

P **STEM MOUNTED KNOT WHEELS** - 1/4" stem - Ideal for somewhat irregular surfaces.



Dia.	Wire Size	No. of Knots	Face Width	Trim Length	Max. RPM	Intermediate Pack	Item Number	
							Steel	Stainless
3-1/4"	.014	20	3/8"	5/8"	25,000	1	17681V •	—
4"	.014	24	1/2"	7/8"	20,000	5	17687V •	—

• Non-stock product, contact Customer Service for lead times and minimum order quantities.

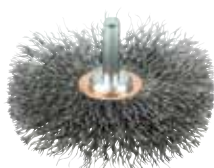

17616V

P **CONFLEX BRUSHES** - Copper center wheels mounted onto a 1/4" stem provide very flexible brushing.



Dia.	Wire Size	Face Width	Trim Length	Max. RPM	Intermediate Pack	Item Number		
						Steel	Stainless	Brass
2"	.0118	3/8"	1/2"	20,000	1	17610V •	17611V •	—
3"	.008	1/2"	1"	20,000	1	17615V •	—	—
	.0118					17616V •	—	17641V
	.014					—	17618V •	—

• Non-stock product, contact Customer Service for lead times and minimum order quantities.

Key:

P Performance line
 Industrial Grade

P **KNOT WIRE CUP BRUSHES** Provide heavy-duty brushing action on relatively flat surfaces.



Diameter	Wire Size	Arbor Hole	Trim Length	Max. RPM	Intermediate Pack	Item Number	
						Steel	Stainless
2-3/4"	.014	5/8"-11 UNC	1"	14,000	1	13025	—
	.020					13286	13258
3-1/2"	.023	5/8"-11 UNC	7/8"	13,000	1	13156	13163
4"	.023	5/8"-11 UNC	1-1/4"	10,200	1	12316	—
5"	.023	5/8"-11 UNC	1-3/8"	9,000	1	12276 *	—
6"	.014	5/8"-11 UNC	1-3/8"	6,600	1	12356	—
	.023					12376	—

* With internal nut

BOLD BLACK ITEM numbers indicate color-coded brushes for easy identification.



P **CRIMPED CUP BRUSHES** Provide consistent performance on light-duty cleaning applications.



Diameter	Wire Size	Arbor Hole	Trim Length	Max. RPM	Intermediate Pack	Item Number
						Steel
3"	.014	5/8"-11 UNC	1"	14,000	1	13245
3-1/2"	.014	5/8"-11 UNC	7/8"	12,000	1	13181
4"	.014	5/8"-11 UNC	1-3/8"	10,200	1	14026
5"	.014	5/8"-11 UNC	1-1/4"	9,000	1	14206
6"	.014	5/8"-11 UNC	1-1/4"	6,600	1	14066 *

* With internal nut



P **UTILITY CRIMPED WIRE CUP BRUSHES** - Small diameter cup brushes for use on air tools.



Diameter	Wire Size	Trim Length	Overall Length	Max. RPM	Intermediate Pack	Item Number
						Steel
1-3/4"	.0118	3/4"	2-5/16"	13,000	1	14301V
2-3/4"	.0118	7/8"	2-1/2"	6,000	1	14302



P **CIRCULAR FLARED END BRUSH** - Suited for broad and slightly contoured surfaces.



Diameter	Wire Size	Max. RPM	Intermediate Pack	Item Number
				Steel
3"	.008	16,000	1	10041V



P **KNOT WIRE END BRUSHES** Provide heavy-duty brushing action in recessed areas.



Diameter	Wire Size	Trim Length	Overall Length	Max. RPM	Intermediate Pack	Item Number	
						Steel	Stainless
3/4"	.020	7/8"	2-5/8"	25,000	3	10026V •	—
	.014					—	10029V •
1-1/8"	.014	7/8"	2-5/8"	22,000	3	10027V •	10031V
	.020					10028V •	—
	.006					10141V * •	—

* Globally sourced product

• Non-stock product, contact Customer Service for lead times and minimum order quantities.
BOLD BLACK ITEM numbers indicate color-coded brushes for easy identification.



P **CRIMPED WIRE END BRUSHES** - Solid end construction for cleaning hard-to-reach areas.



Diameter	Wire Size	Trim Length	Overall Length	Max. RPM	Intermediate Pack	Item Number	
						Steel	Stainless
1/2"	.006	7/8"	2-9/16"	25,000	3	10001V •	10013V
3/4"	.006	7/8"		22,000	3	10005V •	10017V •
	.020					10008V •	—
1"	.006	1"	2-13/16"	22,000	3	10009V •	10021V
	.0104					10010V •	10022V

• Non-stock product, contact Customer Service for lead times and minimum order quantities.
BOLD BLACK ITEM numbers indicate color-coded brushes for easy identification.





P **ROUND TUBE BRUSHES** - Crimped wire fill provides flexible brushing action.



21077V



21110V

Diameter	Wire Size	Brush Part	Stem Diameter	Overall Length	Intermediate Pack	Item Number	
						Steel	Stainless
1/4"	.004	1"	1/8"	3-1/2"	3	—	21081V
3/8"	.004	1"	1/8"	3-1/2"	3	21073V •	—
1/2"	.005	1"	3/16"	3-1/2"	3	21074V	—
5/8"	.005	1"	3/16"	3-1/2"	3	21075V	—
7/8"	.006	1"	7/32"	3-1/2"	3	21077V	—
1"	.008	1"	1/4"	3-1/2"	3	21078V	—
Double Stem, Double Spiral							
1/2"	.006	2"	5/32"	5"	6	21107V •	—
5/8"	.005	2"	7/32"	5"	6	21108V	—
3/4"	.006	2-1/2"	1/4"	5-1/2"	6	21110V	—
1"	.006	2-1/2"	1/4"	5-1/2"	6	21114V	—

• Non-stock product, contact Customer Service for lead times and minimum order quantities.

P **INTERNAL TUBE FITTING BRUSHES** - Wire Fill - For internal cleaning and deburring of copper tube fittings.



44080V

Tube Diameter	Actual Diameter	Brush Length	Overall Length	Handle Length	Intermediate Pack	Item Number
3/8"	1/2"	1"	6-1/2"	3-1/4"	6	44080V

P **ACID BRUSHES** - Horsehair - Tin ferrule (unit packs of 4)



44089V

Width	Trim Length	Overall Length	Intermediate Pack	Item Number
5/16"	3/4"	5-3/4"	6	44088V
3/8"	3/4"	5-3/4"	6	44089V
1/2"	3/4"	5-3/4"	6	44090V

P **SCRATCH BRUSHES** - Ideal for cleaning and prepping surfaces.



44063

Block Size	Brush Length	No. of Rows	Trim Length	Overall Length	Intermediate Pack	Item Number
Steel Wire						
10" x 1-1/8"	5"	4 x 16	1-3/16"	10"	1	44063
14" x 7/8"	5-1/2"	3 x 19	1-3/16"	14"		44053
Stainless Steel Wire						
10" x 1-1/8"	5"	4 x 16	1-3/16"	10"	1	44064
14" x 7/8"	5-1/2"	3 x 19	1-3/16"	14"		44054

P **SMALL SCRATCH BRUSHES** - Ideal for cleaning and prepping surfaces. (unit packs of 3)



44167V

44189V

44637V

Block Size	Block	No. of Rows	Wire Size	Trim Length	Overall Length	Intermediate Pack	Item Number
Stainless Steel Wire							
7-1/2" x 1/2"	Plastic Wood	3 x 7	.006	1/2"	7-1/2"	5	44075V • 44167V
Straight Brass Wire							
7-1/2" x 1/2"	Wood	3 x 7	.006	1/2"	7-1/2"	5	44189V •
Straight Black Nylon							
7-1/2" x 1/2"	Wood	3 x 7	.012	1/2"	7-1/2"	5	44637V •

• Non-stock product, contact Customer Service for lead times and minimum order quantities.

**WHAT YOU NEED.
WHEN YOU NEED IT.**



Key:

P Performance line
Industrial Grade

V Value line
Professional Grade

P **SABER TOOTH™ FLAP DISC** - (Type 29) – Cool, fast cutting.



Diameter	Arbor Hole	Grit Size	Max. RPM	Intermediate Pack	Item Number
Ceramic Alumina Grain, Phenolic Backing					
4-1/2"	5/8"-11 Nut	40	13,000	5	50105V
		60			50106V



50105V

P **TIGER® X FLAP DISC** - (Type 29) - Maximum aggression & long life.



Diameter	Arbor Hole	Grit Size	Max. RPM	Intermediate Pack	Item Number
Zirconia Alumina Grain, Phenolic Backing					
4-1/2"	7/8"	40	13,000	5	51201V •
		60			51202V •
4-1/2"	5/8"-11 Nut	40	13,000	5	51205V •
		60			51206V •



51201V

• Non-stock product, contact Customer Service for lead times and minimum order quantities.

P **BIG CAT® FLAP DISC** - High Density (Type 27) – Increased conformability and maximum life.



Diameter	Arbor Hole	Grit Size	Max. RPM	Intermediate Pack	Item Number
Zirconia Alumina Grain, Phenolic Backing					
4-1/2"	7/8"	40	12,000	5	50803V
		60			50804V
4-1/2"	5/8"-11 Nut	40	12,000	5	50808V
		60			50809V



50804V

P **TIGER FLAP DISC** - (Type 29) - Maximum aggression & long life.



Diameter	Arbor Hole	Grit Size	Max. RPM	Intermediate Pack	Item Number
Zirconia Alumina Grain, Aluminum Backing					
4-1/2"	7/8"	40	13,000	5	50513V
		60			50514V
4-1/2"	5/8"-11 Nut	40	13,000	5	50518V
		60			50519V



50513V

P **TRIMMABLE TIGER® FLAP DISC** - (Type 29) – Trimmable backing for extended disc life.



Diameter	Arbor Hole	Grit Size	Max. RPM	Intermediate Pack	Item Number
4-1/2"	5/8"-11 Nut	40	13,000	5	50006V
		60			50007V



50007V

P **TIGER PAW™ FLAP DISC** - (Type 29) – 100% Zirconia Alumina grain for performance & long life.



Diameter	Arbor Hole	Grit Size	Max. RPM	Intermediate Pack	Item Number
4-1/2"	7/8"	40	13,000	5	51119V
		60			51120V
4-1/2"	5/8"-11 Nut	40	13,000	5	51124V
		60			51125V



51120V

V **WOLVERINE® MOUNTED FLAP WHEELS** - 1/4" Stem – Provide fast action at a value price.



Diameter	Width	Grit Size	Max. RPM	Intermediate Pack	Item Number
1"	1"	60	30,000	3	30720V
		80			30721V
2"	1"	60	25,000	1	30723V
		80			30724V
3"	1"	60	23,000	1	30726V
		80			30727V



30726V

DISPLAY READY

Weiler industrial grade items are available in highly visible packaging, ready to hang on a display. Customers can see products and compare specifications, enabling them to easily pick the right product for the job. Package labeling includes important technical information and UPC bar codes. A multi-lingual safety slip is included with all products, providing comprehensive information on the safe use of the product.

FOR IN-STORE DISPLAY SOLUTIONS
contact your Weiler District Sales Manager.



P **STANDARD TWIST WHEELS** provide heavy-duty brushing action with some flexibility; ideal for demanding cleaning applications on somewhat irregular surfaces.



Dia.	Wire Size	Arbor Hole	No. of Knots	Face Width	Trim Length	Max. AH Avail.	Thickness at Face Plates	Max. RPM	Std. Pack	Item Number	
										Steel	Stainless
3"	.014	1/2"-3/8"	20	3/8"	5/8"	1/2"	7/16"	25,000	1	08014P •	—
4"	.014	1/2"-3/8"	24	1/2"	7/8"	1/2"	7/16"	20,000	1	08044P •	—
4"	.014	5/8"-11	24	1/2"	7/8"	—	7/16"	20,000	1	13106P	13113P
6"	.014	5/8"-1/2"	24	1/2"	1-3/8"	1-1/4"	9/16"	9,000	1	08085P •	—

• Non-stock product, contact Customer Service for lead times and minimum order quantities.
BOLD BLACK ITEM numbers indicate color-coded brushes for easy identification.



13106P

P **CABLE TWIST WHEEL** provides maximum brushing action with minimal flexibility; ideal for demanding cleaning and surface preparation applications on smooth surfaces.



Dia.	Wire Size	Arbor Hole	No. of Knots	Face Width	Trim Length	Max. AH Avail.	Thickness at Face Plates	Max. RPM	Std. Pack	Item No.
										Steel
4"	.020	5/8"-11 UNC	24	1/4"	7/8"	1/2"	7/16"	20,000	1	13266P



13266P

P **ROUGHNECK® STRINGER BEAD WHEELS** - Maximum impact action for fast removal of slag, spatter, oxidation as well as other surface prep and cleaning applications.



Diameter	Wire Size	Arbor Hole	No. of Knots	Face Width	Trim Length	Thickness at Face Plates	Max. RPM	Standard Pack	Item Number	
									Steel	Stainless
4"	.020	M10 x 1.25	32	3/16"	7/8"	7/16"	20,000	1	13125P •	—
		5/8"-11 UNC							13131P	13138P
6"	.020	5/8"-11 UNC	56	3/16"	1-1/8"	7/16"	12,500	1	09400P	—
	.023	5/8"-11 UNC	24	1/2"	1-3/8"	9/16"			08776P	—
7"	.020	5/8"-11 UNC	56	3/16"	1-1/8"	7/16"	9,000	1	09000P	—

• Non-stock product, contact Customer Service for lead times and minimum order quantities.
BOLD BLACK ITEM numbers indicate color-coded brushes for easy identification.



13131P

P **CRIMPED WIRE WHEELS** provide a flexible brushing action and consistent performance for demanding light-duty cleaning and deburring applications.



Dia.	Wire Size	Arbor Hole	Face Width	Trim Length	Max. AH Avail.	Thickness at Face Plates	Max. RPM	Std. Pack	Item Number	
									Steel	Stainless
6"	.014	5/8"-1/2"	3/4"	1-7/16"	1-1/4"	7/16"	6,000	1	01075P	—
			5/8"	1-1/16"	—	1/2"			02325P	—
			7/8"	1-1/8"	—	7/8"			06645P	—
7"	.014	5/8"-1/2"	3/4"	1-9/16"	—	1/2"	6,000	1	02335P •	—
8"	.014	5/8"	3/4"	2-1/16"	1-1/4"	1/2"	6,000	1	01175P •	—

• Non-stock product, contact Customer Service for lead times and minimum order quantities.



01075P

P **CONFLEX BRUSHES** - Small diameter copper center wheels permanently mounted onto a 1/4" stem to provide a very flexible brushing action.



Diameter	Wire Size	Face Width	Trim Length	Max. RPM	Standard Pack	Item Number	
						Steel	Stainless
3"	.008	1/2"	1"	20,000	1	17615P •	—
	.014					17617P •	—

• Non-stock product, contact Customer Service for lead times and minimum order quantities.



17617P

Key:

- P** Performance line Industrial Grade
- V** Value line Professional Grade



12316P

P **KNOT WIRE CUP BRUSHES - Single Row** - Provide heavy-duty brushing action with some flexibility; ideal for demanding cleaning applications on relatively flat surfaces.



Diameter	Wire Size	Arbor Hole	Trim Length	Max. RPM	Standard Pack	Item Number
						Steel
2-3/4"	.014	5/8"-11 UNC	1"	14,000	1	13025P
2-3/4"	.020	M10 x 1.25 5/8"-11 UNC	1"	14,000	1	13281P • 13286P
3-1/2"	.023	5/8"-11 UNC	7/8"	13,000	1	13156P
4"	.023	5/8"-11 UNC	1-1/4"	10,200	1	12316P
5"	.023	5/8"-11 UNC	1-3/8"	7,000	1	12276P* •
6"	.023	5/8"-11 UNC	1-3/8"	6,600	1	12376P

* With internal nut

• Non-stock product, contact Customer Service for lead times and minimum order quantities.



13245P

P **CRIMPED WIRE CUP BRUSHES** provide very flexible brushing action and the most consistent performance for demanding light-duty cleaning applications; feature a threaded nut for use on angle grinders.



Diameter	Wire Size	Arbor Hole	Trim Length	Max. RPM	Standard Pack	Item Number
						Steel
3"	.014	M10 x 1.25 5/8"-11 UNC	1"	14,000	1	13240P • 13245P
4"	.020	5/8"-11 UNC	1-3/8"	9,000	1	14036P
6"	.020	5/8"-11 UNC	1-1/4"	6,600	1	14076P* •

* With internal nut

• Non-stock product, contact Customer Service for lead times and minimum order quantities.



07771P

P **THREADED ADAPTERS** - For mounting brushes with a 5/8"-11 UNC nut to other threaded spindles.

Fixed Thread Size	Adapted Thread Size	Standard Pack	Item Number
5/8" - 11 UNC	M10 x 1.25	1	07771P
5/8" - 11 UNC	M10 x 1.50	1	07772P



10028P

P **KNOT WIRE END BRUSHES** - Feature a hollow end and heavy-duty brushing action with some flexibility; ideal for more demanding cleaning applications in recessed areas.



Diameter	Wire Size	Trim Length	Overall Length	Max. RPM	Standard Pack	Item Number
						Steel
3/4"	.014	1-1/8"	2-5/8"	22,000	1	10025P • 10026P
1-1/8"	.014	7/8"	2-5/8"	22,000	1	10027P 10028P

• Non-stock product, contact Customer Service for lead times and minimum order quantities.



10012P

P **CRIMPED WIRE END BRUSH** - Feature a solid end construction and very flexible brushing action ideal for more demanding light-duty cleaning applications in corners and hard-to-reach areas.



Diameter	Wire Size	Trim Length	Overall Length	Max. RPM	Standard Pack	Item Number
						Steel
3/4"	.020	7/8"	2-9/16"	22,000	1	10008P •
1"		1-1/8"	2-5/8"	20,000		10012P •

• Non-stock product, contact Customer Service for lead times and minimum order quantities.

P **MINI-GRINDER KIT** - For use on small right angle grinders. All products have a 5/8"-11 Arbor Hole



Kit Contains	Item Number
4-1/2" Abrasive Flap Disc (Zirconium Grain, 60 Grit); Item #50519: For grinding and finishing in one step.	13001
2-3/4" Knot Wire Cup Brush (.020 Steel Wire); Item #13286: For cleaning large surface areas.	
4" Stringer Bead Knot Wire Wheel (.020 Steel Wire); Item #13131 For weld cleaning, deburring and surface preparation.	



13001

P **AIR TOOL/DRILL ACCESSORY KIT** -All products have a 1/4" Stem and are ideal for general purpose cleaning and deburring in recessed or confined areas.



Kit Contains	Item Number
3" Crimped Wire Wheel (.0118 Steel Wire); Item #17616	13002
1-3/4" Crimped Wire Cup Brush (.0118 Steel Wire); Item #14301	
3/4" Crimped Wire End Brush (.020 Steel Wire); Item #10008	
3" Abrasive Flap Wheel (Aluminum Oxide Grain, 80 Grit); Item #52028	



13002

P **STAINLESS STEEL SCRATCH BRUSH COUNTERTOP DISPLAY**

Ideal for removing rust, scale and paint from metal surfaces.

Display Contains	Item Number
(36) Stainless Steel Small Hand Scratch Brushes, 7-1/2" x 1/2" Block Wood Handle; Item #44167	61012



61012

Key:

P Performance line
Industrial Grade

V Value line
Professional Grade



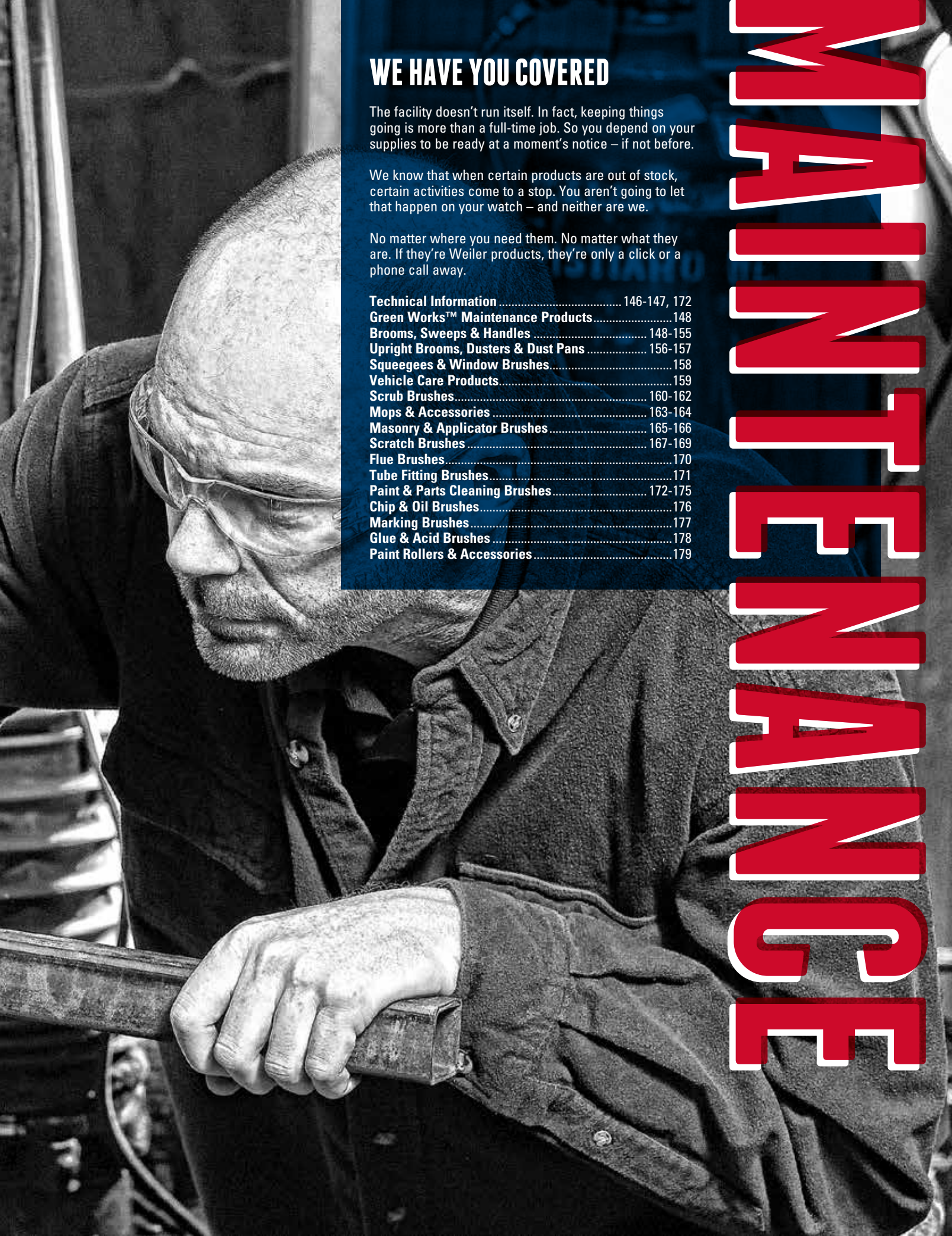

WE HAVE YOU COVERED

The facility doesn't run itself. In fact, keeping things going is more than a full-time job. So you depend on your supplies to be ready at a moment's notice – if not before.

We know that when certain products are out of stock, certain activities come to a stop. You aren't going to let that happen on your watch – and neither are we.

No matter where you need them. No matter what they are. If they're Weiler products, they're only a click or a phone call away.

Technical Information	146-147, 172
Green Works™ Maintenance Products.....	148
Brooms, Sweeps & Handles	148-155
Upright Brooms, Dusters & Dust Pans	156-157
Squeegees & Window Brushes.....	158
Vehicle Care Products.....	159
Scrub Brushes.....	160-162
Mops & Accessories	163-164
Masonry & Applicator Brushes	165-166
Scratch Brushes	167-169
Flue Brushes.....	170
Tube Fitting Brushes.....	171
Paint & Parts Cleaning Brushes.....	172-175
Chip & Oil Brushes.....	176
Marking Brushes.....	177
Glue & Acid Brushes.....	178
Paint Rollers & Accessories.....	179

MAINTENANCE

SELECTING THE RIGHT BRUSH

P PERFORMANCE LINE (INDUSTRIAL GRADE)

Engineered and manufactured to maximize performance and minimize operating costs in the most demanding surface conditioning applications. The use of superior construction, the highest quality materials and the most stringent manufacturing processes deliver the lowest cost-of-use and most consistent performance in heavy production environments.

V VALUE LINE (PROFESSIONAL GRADE)

Weiler's value line is manufactured using similar product construction and the same exacting standards as other Weiler maintenance products, but engineered to provide cost-effective use specifically designed for the professional, providing a cost-effective price. Vortec Pro® maintenance products are an economical choice for the construction trades, low volume production shops and light-duty industrial MRO use.

FILL MATERIALS GUIDE

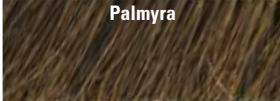
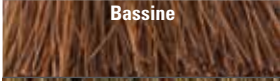
	Type	Advantages	Applications	Notes
ANIMAL	 Horsehair	<ul style="list-style-type: none"> • Very durable and resilient • Naturally flagged tips • Resistant to high temperatures (to 370°F) • Can be blended with other materials • Fine texture 	<ul style="list-style-type: none"> • Fine particles • Ideal for polished and smooth surfaces • Scratch-free sweeping 	<ul style="list-style-type: none"> • Not for use on oily or wet surfaces
NATURAL	 Tampico	<ul style="list-style-type: none"> • Material holds water very well • Heat, alkali and acid resistant (to 283°F) • Soft to medium texture • Good durability 	<ul style="list-style-type: none"> • Polishing, buffing and cleaning • Scrubbing and washing • Ideal for wet and dry applications 	<ul style="list-style-type: none"> • Natural color is off white • Can be dyed or bleached
	 Palmyra	<ul style="list-style-type: none"> • Softer and finer texture than Bassine • More economical than Bassine • Medium to coarse texture • Good durability 	<ul style="list-style-type: none"> • Used in garage, scrub, deck and patio brushes • Ideal for wet and dry applications 	<ul style="list-style-type: none"> • Brown in color
	 Bassine	<ul style="list-style-type: none"> • Coarse, tough fibers • Excellent durability 	<ul style="list-style-type: none"> • Heavy scrubbing and cleaning • Tasks requiring a tough, long-lasting natural fiber 	<ul style="list-style-type: none"> • Dark brown in color
	 Bass	<ul style="list-style-type: none"> • Good flexibility • Very coarse, tough fibers • Excellent durability 	<ul style="list-style-type: none"> • Heavy-duty cleaning applications • Use on rough surfaces 	<ul style="list-style-type: none"> • Dark brown in color
SYNTHETIC	 Nylon	<ul style="list-style-type: none"> • Excellent durability • Resistant to most acids & alkali • High water absorbency • Resistant to high temperatures (to 350°F) • Best man-made fiber to resist fatigue 	<ul style="list-style-type: none"> • Heavy-duty industrial • Scrubbing and cleaning • Wet and dry applications 	<ul style="list-style-type: none"> • May be level or crimped
	 Polypropylene	<ul style="list-style-type: none"> • Very durable • Acid, oil, bacteria and fungus resistant • Versatile • Resistant to high temperatures (to 225°F) • Will not absorb moisture 	<ul style="list-style-type: none"> • Variety of medium to coarse industrial applications 	<ul style="list-style-type: none"> • May be level or crimped
	 Polystyrene	<ul style="list-style-type: none"> • Extremely durable • Liquid and oil resistant • Resistant to temperatures (to 180°F) • Ends can be flagged 	<ul style="list-style-type: none"> • Used in vehicle care brushes • Used in fruit and vegetable wash brushes • Wet and dry applications 	<ul style="list-style-type: none"> • May be level or crimped • Not for use with sweeping compounds
	 Recycled PET	<ul style="list-style-type: none"> • Environmentally-friendly • Less landfill waste 	<ul style="list-style-type: none"> • Fine, Medium & Coarse • For a variety of applications 	<ul style="list-style-type: none"> • Fill made from recycled water bottles

FLOOR BRUSH SELECTION GUIDE

Surface Type	Debris	Recommended Brush
Tile, linoleum, highly polished	Fine dust	Black horsehair
Smooth wood	Fine to medium dirt	Flagged silver polystyrene
Smooth concrete	Fine to medium dirt	Black polypropylene
Uneven or rough floors, heavy traffic areas	Medium to heavy dirt and debris	Black tampico
Rough concrete, asphalt	Heavy, caked dirt, grease, litter	Black tampico - inner row of steel wire or palmyra

FLOOR BRUSH FEATURES

Block: Fill material is set into this part of the sweep.

Synthetic Foam Block:

- Made with a synthetic cellular core surrounded by a solid skin.
- Will not crack, split, warp or house contaminating bacteria.
- Water, solvent and mild acid resistant.
- Lighter weight than hardwood blocks.

Lacquered Hardwood Block:

- Made of natural, kiln-dried hardwood.
- Resists moisture.
- Helps prevent cracking, increasing brush life.

Dense Fill:

- Set into the block and serves as the actual working part of the brush.
- More efficient sweeping.
- Longer brush life.

Reorder Number:

- Shown on block.

Two Handle Holes:

- Allows user to change sweeping direction to prevent the fill material from setting in one direction. Periodically changing sweeping direction increases the life of the brush.

Staggered Hole Pattern:

- Prevents gaps in the fill material so brush sweeps up all the dirt in its path.



Flagged Tips:

- Each synthetic filament end is mechanically split, forming multiple tips which "pick up" fine dust and dirt particles. Horsehair has naturally tapered or flagged tips.



Center / Border Fill



Border (Casing)

Moves fine dust and dirt

Center

Loosens and moves heavy dirt

Solid Brush Face with Flared Ends:

- The tufts of fill material on each end of a contractor, floor, garage or street brush are flared outward.
- Flared ends allow the brushing material to get into corners without marking or scraping the wall with the block.
- Prevents a gap in the middle of the brush.

FLOOR BRUSH CARE

Storage - Floor brushes should be hung when not in use so no weight is against the fill material. This will help keep the shape and prolong the life of the brush.

Handles - The handle should be periodically re-positioned from one staff hole to the other to prevent fill material from setting in one position. The use of a brace will help prevent handle breakage. Perma-Flex™ (#44301) handles are guaranteed to outlast the life of the brush.

Blocks - Avoid knocking a wood block against the floor to remove embedded material, as this will damage the end of the block.

Cleaning - Synthetic filled brushes can be cleaned with detergent and water. Fiber filled brushes should be combed to remove dirt and other foreign material. Dip coarse natural fiber brushes in water to help prevent breakage due to dry fiber.

GREEN WORKS™ MAINTENANCE PRODUCTS



36 billion water bottles end up in landfills every year. Help us make a difference!

Sustainable, recyclable, environmentally-friendly, Green - all of these come to mind with the new Green Works line from Weiler. Made from recycled or sustainable raw materials, the Green Works line is manufactured in a LEED (Leadership in Energy & Environmental Design) approved facility to ensure that even the production environment is environmentally-friendly. All of this, plus the same great performance! Every product is made to the quality levels you expect when you hear the name Weiler.

Green Works Product Construction:

- Fill material is made out of recycled water bottles, giving a second life to these waste products and helping to clean up the environment.
- Rubberwood blocks are made from the wood of rubber trees that have ended their life cycle in the rubber production industry. We are putting the waste product of that industry to good use.
- Foam blocks are made from recycled plastics.



42352

P **FLOOR SWEEPS** - Choose from flagged tips that pick-up fine dust and dirt to durable fibers that sweep heavy, caked dirt and debris.

Block Size	Block Type	Fill Material	Trim Length	Standard Pack	Item Number
Fine Sweeping - For fine dust and dirt on smooth surfaces					
24"	Recycled Black Foam	Recycled Grey Fill	3"	12	42352
24"	Renewable Rubberwood	Recycled Grey Fill	3"	12	42355
Medium Sweeping - For general purpose sweeping on semi-smooth surfaces					
24"	Recycled Black Foam	Recycled Blue Fill	3"	12	42353
24"	Renewable Rubberwood	Recycled Blue Fill	3"	12	42356
Coarse Sweeping - For heavy dirt and debris on very rough surfaces					
24"	Recycled Black Foam	Recycled Maroon Fill	3"	12	42354
24"	Renewable Rubberwood	Recycled Maroon Fill	3"	12	42357

Handle #44018 or #44300 are recommended for use with these sweeps.



42357



42360

P **STREET BROOM** - Ideal for wet or dry sweeping on streets, parking lots, loading docks and driveways.

Block Size	Block Type	Fill Material	Trim Length	Standard Pack	Item Number
16"	Renewable Rubberwood	Recycled Black Fill	6"	6	42360

Handle #44020 is recommended for use with this broom.



42365

P **DUO SWEEP** - Heavy-duty upright with two handle holes - one straight and one angled.

Size	Block Type	Fill Material	Trim Length	Standard Pack	Item Number
9"	Recycled Black Foam	Recycled Yellow Fill	7"	12	42365

Handle #42383 is recommended for use with this sweep.



42368

P **COUNTER DUSTER** - Ideal for quick clean-ups. Features a comfortable grip handle.

Block Size	Block Type	Fill Material	Trim Length	Overall Length	Std. Pack	Item Number
8"	Recycled Black Foam	Recycled Grey Fill	2-1/2"	13-1/8"	12	42368



42371

P **SCRUB BRUSHES** - Designed to provide the most effective brushing and cleaning action.

Block Size	Type	Block Type	Fill Material	Standard Pack	Item Number
8"	Utility	Recycled Black Foam	Recycled Yellow Fill	12	42375
9"	Pointed Deck	Renewable Rubberwood	Recycled Yellow Fill	12	42373
10"	Deck	Renewable Rubberwood	Recycled Yellow Fill	12	42371
	Bi-Level	Recycled Black Foam			42372
20"	Utility	Recycled Black Foam	Recycled Yellow Fill	12	42376

Handle #44018 or #44300 are recommended for use with these scrub brushes.



42375

Key:

P Performance line
Industrial Grade

V Value line
Professional Grade

QUICK ASSEMBLY & UNBREAKABLE!

Easy-to-Assemble: The convenient and easy-to-assemble T-knob construction of the Pro-Flex Sweep takes less than 1 minute to assemble. The handle connects easily and securely to the broom head, and there's no need for a brace!

Unbreakable: Utilizing an advanced polymer technology, the Pro-Flex Sweep's unique handle/sweep connector flexes on impact, providing unbelievable shock absorbency...and it's unbreakable! Ideal for the most demanding applications on a construction site.

More Maneuverable: Without the need for a brace, the Pro-Flex Sweep is lighter, easy to maneuver and eliminates potential damage to low surface areas.

The Pro-Flex Sweep... the strongest sweep on the market AND the easiest to assemble!



Flexible connection makes these sweeps the strongest on the market!



The Pro-Flex Sweep's indestructible design will make it the last sweep you will ever buy!

P PRO-FLEX SWEEPS - Hardwood Block

Includes comfort grip Pro-Flex handle and scraper for removal of heavy, caked dirt and debris.

Block Size	Fill Material	Trim Length	Standard Pack	Item Number
Convenient scraper attaches handle to sweep head for display and shipping purposes				
24"	Flagged Grey Polystyrene Border with Stiff Black Polypropylene Center	3"	1	44600 ■
24"	Palmyra	4"	1	44601 ■
24"	Medium Maroon Polypropylene	3-1/4"	1	44604 ■
24"	Stiff Blue Polypropylene	3-1/4"	1	44606 ■

■ Packaged product available. See pages 141-142 for details.

QUICK ASSEMBLY - NO TOOLS REQUIRED!



Remove nuts from broom assembly



Flip scraper and place over bolts



Place handle connector over bolts and tighten nuts securely



44606

COATED ABRASIVES

NON-WOVEN ABRASIVES

POWER BRUSHES

NYLON BRUSHES

PACKAGED ITEMS

MAINTENANCE

SPECIALTY FLOOR BRUSHES



Sweeping leaves from a garage floor.

CONTRACTOR BROOMS - Designed to withstand rugged, every day use. The 1-1/8" bolt-on handle design combined with a lacquered hardwood block and 12-gauge steel brace makes the Contractor Broom the most durable sweep in our product line.

P

CONTRACTOR BROOMS - Hardwood Block - Heavy-duty brace included with all brooms. Ideal for construction sites and other heavy use environments.

Block Size	Fill Material	Trim Length	Standard Pack	Item Number
Fine Sweeping - For fine dust and dirt on smooth surfaces				
24"	Flagged Silver Polystyrene	3"	1	44553
Medium Sweeping - For general purpose sweeping on semi-smooth surfaces				
24"	Flagged Grey Polystyrene Border with Stiff Black Polypropylene Center	3"	1	44581
30"				44582 •
Coarse Sweeping - For heavy dirt and debris on very rough surfaces				
24"	Palmyra	4"	1	44584
24"	Medium Maroon Polypropylene	3-1/4"	1	44587
24"	Stiff Blue Polypropylene	3-1/4"	1	44590
30"				44591 •

• Non-stock product, contact Customer Service for lead times and minimum order quantities.

NOTE



- For Contractor Brooms, use Handle No. 44635 (1-1/8" x 60").
- Handle not included in price - order handle separately.
- Bolt to assemble broom is included with the broom, not with the handle.



PERMA-SWEEP™ FLOOR BRUSHES - Weiler offers color-coded floor sweeps to make product selection and identification easier. Constructed with foam blocks and synthetic filaments, these materials are durable, resist acid and bacteria and can be used in wet or dry sweeping applications.

P

PERMA-SWEEP - Synthetic Foam Block - Made of durable materials designed to resist acid and bacteria.

Block Size	Fill Material	Trim Length	Standard Pack	Item Number
Fine Sweeping - For fine dust and dirt on smooth surfaces				
18"	Flagged Green Polystyrene	3"	1	42163
24"				42164
Medium Sweeping - For general purpose sweeping on semi-smooth surfaces				
18"	Yellow Polypropylene	3"	1	42165
24"				42166
Coarse Sweeping - For heavy dirt and debris on very rough surfaces				
18"	Maroon Polypropylene	3"	1	42167
24"				42168

NOTE



- For Perma-Sweep Floor Brushes, use Perma-Flex Handle No. 44301 (15/16" x 60") Guaranteed for the life of the brush!
- Handle not included in price - order handle separately.



FLOOR BRUSHES

Weiler offers a broad array of floor brushes in various sizes and fill materials for fine, medium and coarse sweeping applications. Choose from flagged tips that pick up fine dust and dirt to durable fibers that sweep heavy-caked dirt and debris. The lacquered hardwood blocks resist moisture and help prevent cracking, thereby increasing brush life.



Sweeping saw dust on a smooth surface.

NOTE



- Handle No. 44300 (15/16" x 60") recommended for use with all Floor Brushes.
- Handle not included in price - order handle separately.

P FINE SWEEPS - Lacquered Hardwood Block

For dust and fine dirt on smooth surfaces: Tile, Wood, Linoleum, Marble, Ceramic Tile and Smooth Concrete.

Block Size	Fill Material	Trim Length	Standard Pack	Item Number	★ Combo Qty. Item Number
18"	Black Horsehair	3"	1	42001	44855 •
24"				42002	44856 •
18"	Black Horsehair and Black Polypropylene Blend	3"	1	42013	—
24"				42014	—
10"	Flagged Silver Polystyrene	3"	12	70312	—
18"				42041	44857 •
24"				42042	44858 •
36"				42098*	—

★ Combo Packs include 12 sweeps per pack and 12 #44300 handles (not assembled).
* Brace included

• Non-stock product, contact Customer Service for lead times and minimum order quantities.



42001



42042

V VORTEC PRO® FINE SWEEPS - Lacquered Hardwood Block

Reliable and efficient sweeps at a value price.

Block Size	Fill Material	Trim Length	Standard Pack	Item Number
18"	Flagged Grey Polystyrene	3"	12	77013
24"				77014



77013

P MEDIUM SWEEPS - Lacquered Hardwood Block

General purpose sweeping on semi-smooth surfaces: Wood, Smooth Concrete, Asphalt and Factory/Shop Floors.

Block Size	Fill Material	Trim Length	Standard Pack	Item Number	★ Combo Qty. Item Number
14"	Black Tampico	3"	1	42114	—
16"				42006	—
18"				42007	44859 •
24"				42008	44860 •
36"				42047*	—
18"	Horsehair Border with Black Tampico Center	3"	1	42016	—
24"				42017	—
36"				42049*	—
24"	Horsehair and Polystyrene Border with Black Polypropylene Center	3"	1	70068 •	—
18"	Black Polypropylene	3"	1	42035	44861 •
24"				42037	44862 •
36"				42095*	—

★ Combo Packs include 12 sweeps per pack and 12 #44300 handles (not assembled).
* Brace included

• Non-stock product, contact Customer Service for lead times and minimum order quantities.



42007

V VORTEC PRO MEDIUM SWEEPS - Lacquered Hardwood Block

Reliable and efficient sweeps at a value price.

Block Size	Fill Material	Trim Length	Standard Pack	Item Number	★ Combo Qty. Item Number
18"	Dark Grey Polystyrene Border with Black Polypropylene Center	3"	1	25234	44851 •
24"				25235	44852 •
18"	Black Tampico	3"	1	25231	44853 •
24"				25232	44819 •

★ Combo Packs include 12 sweeps per pack and 12 #44300 handles (not assembled).

• Non-stock product, contact Customer Service for lead times and minimum order quantities.



25234

COATED ABRASIVES

NON-WOVEN ABRASIVES

POWER BRUSHES

NYLON BRUSHES

PACKAGED ITEMS

MAINTENANCE

P**COARSE SWEEPS - Lacquered Hardwood Block**

For heavy dirt and debris on rough surfaces: Wood, Concrete, Asphalt and Brick.

Block Size	Fill Material	Trim Length	Standard Pack	Item Number	★ Combo Qty. Item Number
18"	Black Tampico with 1 row	3"	1	42134	44871 •
24"	Tempered Steel Wire in Center			42135	44872 •

★ Combo Packs include 12 sweeps per pack and 12 #44300 handles (not assembled).

• Non-stock product, contact Customer Service for lead times and minimum order quantities.



42135

NOTE

- Handle No. 44300 (15/16" x 60") recommended for use with all Floor Brushes.
- Handle not included in price - order handle separately.

STRIP BROOMS - The corrosion-resistant frame is lightweight, resulting in less user fatigue! Efficient and economical, Strip Brooms make quick work of dirt and debris on all types of surfaces.**V****VORTEC PRO® STRIP BROOMS** - Economy brushes provide lasting, efficient service at minimal cost.

Block Size	Fill Material	Trim Length	Standard Pack	Item Number
Fine Sweeping - For smooth surfaces				
24"	Green Polypropylene	3"	12	25299
Medium Sweeping - For semi-rough surfaces				
18"	Red Polypropylene	3"	12	25290
24"				25291
Coarse Sweeping - For rough surfaces				
18"	Brown Polypropylene	3"	12	25294 •
24"				25295

• Non-stock product, contact Customer Service for lead times and minimum order quantities.

NOTE

- For Strip Brooms, use Handle No. 25297 (15/16" x 60").
- Handle not included in price - order handle separately.



25299



25290



25294



73180

P**DRIVEWAY COATERS** - For applying blacktop driveway and parking lot dressings; asphalt, sealers or roof coatings.

Block Size	Fill Material	Trim Length	Standard Pack	Item Number	★ Combo Qty. Item Number
10"	Black Tampico	2-5/8"	12	73180	-
18"	Palmyra	2"	12	73182*	44885 •

★ Combo Packs include 12 brushes per pack and 12 #75527 handles (not assembled).

* With squeegee

• Non-stock product, contact Customer Service for lead times and minimum order quantities.

NOTE

- Handle No. 75527 (7/8" x 48") recommended for Driveway Coaters.
- Handle not included in price - order handle separately.

Key:

P Performance line
Industrial Grade**V** Value line
Professional Grade

P GARAGE BRUSHES - Lacquered Hardwood Block

For wet or dry sweeping heavy, caked dirt and debris on rough surfaces: Concrete, Garage/Factory Floors, Rough Wood, Sidewalks, Barns and Brick Surfaces. Solvent, oil, chemical and liquid resistant.

Block Size	Fill Material	Trim Length	Standard Pack	Item Number	★ Combo Qty. Item Number
16"	Palmyra	4"	1	42021	—
18"				42022	44867 •
24"				42023	44868 •
36"				42138*	—
18"	Maroon Polypropylene	3-1/4"	1	42025	—
24"				42026	—
36"				42149*	—

★ Combo Packs include 12 sweeps per pack and 12 #44300 handles (not assembled).
* Brace included

• Non-stock product, contact Customer Service for lead times and minimum order quantities.



Sweeping metal shavings from a shop floor.

V VORTEC PRO® GARAGE BRUSHES - Lacquered Hardwood Block

Reliable and efficient brushes at a value price.

Block Size	Fill Material	Trim Length	Standard Pack	Item Number	★ Combo Qty. Item Number
18"	Palmyra	4"	1	25241	44865 •
24"				25242	44866 •
18"	Maroon Polypropylene	3-1/4"	1	25238	44863 •
24"				25239	44864 •

★ Combo Packs include 12 sweeps per pack and 12 #44300 handles (not assembled).

• Non-stock product, contact Customer Service for lead times and minimum order quantities.



NOTE



- Handle No. 44435 (1-1/8" x 60") recommended for use with all Garage Brushes.
- Handle not included in price - order handle separately.

P STREET BROOMS - Hardwood Block - Wide flared ends for sweeping close to curbs and walls. For heavy-duty wet or dry sweeping: Streets, Sidewalks, Loading Docks, Parking Lots, Driveways and all Asphalt Surfaces.

Block Size	Fill Material	Trim Length	Standard Pack	Item Number	★ Combo Qty. Item Number
16"	Natural Palmyra	6-1/4"	6	70208	—
16"	Dyed Palmyra	6-1/4"	6	70209	—
16"	Bass & Palmyra Blend	6-1/4"	6	42032	44873 •
16"		7-1/4"		42099	—
16"	Brown Polypropylene	5-1/4"	6	42033	44874 •
18"				42173	—
24"				42174	—
16"	Orange Polypropylene	5-1/4"	6	70212	—
18"				42054	—
24"				42055	—
14"	White Polypropylene Fill Orange Block	4"	6	70210	—
16"				70211	—

★ Combo Packs include 12 brooms per pack and 12 #44020 handles (not assembled).

• Non-stock product, contact Customer Service for lead times and minimum order quantities.



P WIRE BROOMS - Hardwood Block

For sweeping or scrubbing concrete or stone floors, driveways, etc. Ideal for sweeping heavy chips and debris.

Block Size	Fill Material	Trim Length	Standard Pack	Item Number
14"	Flat Wire	5"	1	42030
16"	Round Wire	3-3/4"	6	70215

NOTE



- Street and wire brooms require a tapered tip handle.
- Handle No. 44020 (1-1/8" x 60") recommended for use with all Street & Wire Brooms.
- Use Spring-Loc Adapter to keep tapered wood handle securely fastened to the block.
- Handle not included in price - order handle separately.



COATED ABRASIVES

NON-WOVEN ABRASIVES

POWER BRUSHES

NYLON BRUSHES

PACKAGED ITEMS

MAINTENANCE

HANDLES, BRACES & TIPS

Weiler's wood and metal handles are constructed for long life. Handles are available in a large variety of styles and tips to fit a wide selection of block types. The following charts provide recommended uses for each style handle.



The Perma-Flex tip is guaranteed not to break when used with a Perma-Sweep.



44018



44020



44300



44301



25297



44635

P WOOD HANDLES - Quality hardwood

Length	Diameter	Tip	Description	Std. Pack	Item No.
48"	7/8"	Threaded Wood	Use with floor and garage brushes.	12	75527
48"	15/16"				44571
54"	15/16"				44572
60"	15/16"				44018
60"	1-1/8"				44019
72"	15/16"	44303			
11"	3/4"	Tapered Wood	Use with masonry and roof brushes, street brooms, floor and deck scrubs and squeegees.	36	75528 •
48"	7/8"				44574
54"	1-1/8"				44573
60"	1-1/8"				44020
72"	1-1/8"				44306
48"	15/16"	Threaded Metal	Heavy-duty metal tip provides additional strength.	12	75525
60"	15/16"				44300
60"	1-1/8"				44435
72"	15/16"				44302
48"	15/16"	Perma-Flex™	Durable threaded plastic tip guaranteed not to break when used with Perma-Sweep™ Floor Brushes.	12	75516
60"	15/16"				44301
60"	15/16"	–	Use with Strip Brooms.	12	25297
60"	1-1/8"	–	Use with Contractor Brooms.	12	44635

• Non-stock product, contact Customer Service for lead times and minimum order quantities.



42383



44577



44578



44578



75555

P METAL HANDLES - Reinforced, heavy-duty metal handles are available in two colors and optional foam cover.

Length	Diameter	Tip	Description	Std. Pack	Item No.
48"	3/4"	Threaded Plastic	Black metal with plastic hang cap.	12	42383
60"	15/16"	Threaded Metal	Black plastic coat with plastic hang cap.	12	44577
60"	15/16"	Threaded Metal	Black plastic coat with black foam cover and plastic hang cap.	12	44578

V VORTEC PRO® METAL HANDLES - Reliable and efficient handles at a value price.

Length	Diameter	Tip	Description	Std. Pack	Item No.
60"	15/16"	Threaded Plastic	Black plastic coat with convenient hang-up cap.	12	75555

P METAL TELESCOPING AND FOUNTAIN TUBE HANDLES - Use telescoping handles to shorten or extend the reach of the handle. Use fountain tube handles when a continuous flow of water is needed, i.e. car/truck washing.

Length	Diameter	Type	Use	Std. Pack	Item No.
6' extends to 12'	-	Telescoping	Window, wall and Vehicle wash brushes	6	44499
5'	7/8"	Fountain Tube	Vehicle wash brushes	12	44319



P FIBERGLASS HANDLES - Fiberglass handles are stronger than wood or metal. Virtually indestructible.

Length	Diameter	Tip	Description	Std. Pack	Item No.
56-3/4"	1"	Tapered/Threaded	Hollow handle	12	44561*
54"	1"	Threaded	Honeycomb core	12	44562
60"	1"	Threaded	All white	12	44563+

* For use with both tapered and threaded holes + Approved for the food service industry



Fiberglass with polyethylene reinforced honeycomb core



Fiberglass hollow handle.



P HANDLE ACCESSORIES

Description	Use	Std. Pack	Item No.
Steel brace. Fits all handle sizes.	Reinforces & locks handle to block. (Standard with sweeps 30" and larger)	12	44021
Heavy-duty steel brace attaches to block with wood screws and wraps around handle. Fits all handle sizes.	Increases life of the brush by providing extra support for handle and block.	12	44290
Replacement handle thread. Made of heavy-duty fiberglass. For any 15/16" diameter handle.	Cut off damaged threads and slip this tip in place for a new handle.	12	44317
Tapered Adapter to tapered ends.	Converts threaded handle ends	12	75505
Spring Loc Adapter for any 1-1/8" diameter tapered wood handle for street brooms and window brushes.	Keeps tapered wood handles from separating from the block.	6	44624



Key:

- P** Performance line Industrial Grade
- V** Value line Professional Grade

UPRIGHT AND WHISK BROOMS

Made of fine quality broom corn, fiber or synthetic material, Weiler's upright brooms and whisks are durable enough to meet all industrial and commercial applications.



Sweeping plastic and metal chips in a tool room

P UPRIGHT BROOMS - Ideal for sweeping floors, reaching into corners, cleaning ceilings, etc.



44009

Description	Fill Material	Trim Length	Overall Length	Standard Pack	Item Number
Household Broom - Good Quality					
4 sews - 7/8" handle	Corn & Fiber	15"	54"	12	44547
Light Industrial Brooms - Better Quality					
5 sews - 7/8" handle	Corn & Fiber	17"	57"	12	44548
5 sews - 7/8" handle	100% Corn	15"	56"	12	44009
6 sews - 1-1/8" handle	100% Black Corn	16"	56"	12	70304
Janitor's Broom - Best Quality					
5 sews - 1-1/8" handle Wire banded	Corn & Fiber	17"	57"	12	70308
Warehouse Broom - Heavy-Duty					
4 sews - 1-1/8" handle Wire banded	Corn & Fiber	18"	57"	12	44008

P ANGLE BROOM - Angled trim allows access to corners, under low cabinets and other hard-to-reach areas.



44305

Description	Fill Material	Trim Length	Overall Length	Standard Pack	Item Number
Large Plastic 12" sweep face	Flagged Plastic	7-1/2"-6"	54"	12	44305

V VORTEC PRO® ANGLE BROOM - Reliable and efficient broom at a value price.

Description	Fill Material	Trim Length	Overall Length	Standard Pack	Item Number
Small Plastic 8" sweep face	Flagged Plastic	3-7/8"-4-1/2"	54"	12	75160

P CAP BROOMS - Metal top for added durability. Ideal for wet or dry applications.



70325

Description	Fill Material	Trim Length	Overall Length	Standard Pack	Item Number
Metal Cap - Wire banded 12" sweep face	Palmyra	10"	55"	6	44007
Metal Cap - Wire banded 12" sweep face	Brown Poly	10"	55"	6	70325
Track & Switch Steel chisel point on handle end	Palmyra	8"	55"	6	70324

V VORTEC PRO LOBBY BROOMS - Reliable and efficient brooms at a value price.



70300

Description	Fill Material	Trim Length	Overall Length	Standard Pack	Item Number
Plastic Cap - 8" sweep face	Flagged Plastic	5"	36"	12	44546 •
Toy/Lobby - 3 sews, 7/8" handle	Corn & Fiber	11"	40"	12	70300

• Non-stock product, contact Customer Service for lead times and minimum order quantities.

P WHISK BROOMS - For fast, efficient clean-up.



44266

Use	No. of Sews	Fill Material	Trim Length	Overall Length	Std. Pack	Item No.
General purpose - all applications	3	Corn & Fiber	10"	12-1/2"	12	44266
Sweeping coarse & heavy material	2	Palmetto	7"	9-1/4"	12	44099
Coarse sweeping of hot chips	-	Bassine	5-1/4"	10-1/4"	12	44103

DUSTERS AND DUST PANS

Whether cleaning fine particles or heavy debris, Weiler has a Counter Duster to do the job. These brushes are available in a wide selection of fill materials and have comfortably shaped blocks in wood or foam. Also choose from an array of Dust Pans to meet the application requirements.



Cleaning up oil absorbent from a shop floor.

P COUNTER DUSTERS - For clean up in hard-to-reach areas.

Fill Material	Trim Length	Brush Length	Overall Length	Block Type	Std. Pack	Item No.
Horsehair						
Horsehair	2-1/4"	8"	13-1/4"	Wood	12	44003
	2-1/4"	9"	14-1/4"			44351
Black Horsehair and Fiber Mix	2-1/2"	8"	13-1/2"	Wood	12	71019
Synthetic						
Flagged Silver Polystyrene	2-1/2"	8"	13-1/4"	Wood	12	44354
Black Polystyrene	2-1/2"	8"	13-1/4"	Wood	12	25252
Orange Polystyrene	2"	9"	14"	Foam	12	42213
Natural Fiber						
Black Tampico	2-1/2"	8"	13-1/4"	Wood	12	25251
Tri-colored Tampico	2-1/2"	8"	13-1/2"	Wood	12	44004



44003



42213



44004

P DUST PANS - Durable, industrial grade - For quick clean-ups.

Description	Height	Width	Depth	Std. Pack	Item No.
Heavy-duty 20 gauge steel Black enamel finish	-	12"	13-1/2"	12	71078
Extra wide - Heavy-duty 20 gauge steel; Black enamel finish	-	16"	15"	12	71079
Lobby Dust Pan - Black enamel metal hopper; Aluminum handle	39-1/2"	12"	9"	6	71081 •

• Non-stock product, contact Customer Service for lead times and minimum order quantities.



71078

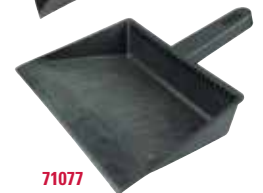

71077

V VORTEC PRO® DUST PANS - Reliable and efficient pans at a value price.

Description	Height	Width	Depth	Std. Pack	Item No.
Molded plastic	-	12-1/4"	12"	12	71077
Lobby Dust Pan Molded plastic hopper Aluminum handle	39-1/2"	12"	11"	6	71080



71080

Key:

P Performance line
Industrial Grade

V Value line
Professional Grade

COATED ABRASIVES

NON-WOVEN ABRASIVES

POWER BRUSHES

NYLON BRUSHES

PACKAGED ITEMS

MAINTENANCE

SQUEEGEES & WINDOW BRUSHES

Squeegees deliver fast, efficient cleaning. Weiler provides a variety of non-scratching floor and window squeegees and window brushes. Designed for high durability.



Cleaning a window with a window squeegee.



45507



45510



45500

P FLOOR SQUEEGEES - Heavy-duty construction, iron handle socket.

Description	Length	Type	Standard Pack	Item Number
Black rubber blade for rough, heavy use	18"	Straight	6	45506
	24"			45507
	30"			45534
	36"			75202
Black rubber blade for rough, heavy use	24"	Curved	6	45510
	30"			45535
	36"			45511

P WINDOW SQUEEGEES - Rust-proof handle socket and frame.

Description	Length	Standard Pack	Item Number
One piece frame with hard rubber section joined with a soft, red rubber blade.	6"	12	45537
	12"		45500
	14"		45538 •

• Non-stock product, contact Customer Service for lead times and minimum order quantities.

NOTE



- All squeegees require a tapered tip handle.
- Handle No. 44020 (1-1/8" x 60") recommended for use with all Squeegees.
- Use Spring-Loc Adapter to keep tapered wood handle securely fastened to the block.
- Handle not included in price - order handle separately.



25271

V ROUND STYLE WINDOW BRUSH - Two threaded handle holes High quality, non-scratching brushes used for industrial window washing.

Description	Block Size	Block	Trim Length	Standard Pack	Item Number
Flagged Gold Polystyrene	4-1/2"	Plastic	2-1/2"	12	25271

NOTE



- Handle No. 44019 (1-1/8" x 60") recommended for use with #25271 & #73003 Window Brushes.
- Handle not included in price - order handle separately.

Key:

P Performance line
Industrial Grade

V Value line
Professional Grade

VEHICLE CARE PRODUCTS

Weiler's line of vehicle care brushes meets the cleaning needs of car and truck fleets. Brushes are also popular in the marine industry. All products are designed to provide professional results.



Washing a car with a vehicle wash brush and fountain tube handle.

P VEHICLE WASH BRUSHES - Protective bumper - Foam block with two handle holes. Can be used with flow-through handle #44319 on page 147.

Block Size	Fill Material	Trim Length	Standard Pack	Item Number	★ Combo Qty. Item Number
9-1/2" x 2-3/4"	Grey Fiber	2-1/2"	12	44318*	-
9-1/2" x 2-3/4"	Flagged White Polystyrene	2-1/2"	12	44510	44875 •
9-1/2" x 2-3/4"	Flagged Orange Polystyrene	2-1/2"	12	42210	-
9-1/2" x 2-3/4"	Flagged Green Polystyrene	2-1/2"	12	73146	-

* May scratch smooth or high gloss surfaces, use polystyrene filled products for these surfaces.

• Non-stock product, contact Customer Service for lead times and minimum order quantities.

★ Combo Packs include 12 brushes per pack and 12 #44319 handles (not assembled).



44510

P SCHOOL BUS BRUSH - Easily sweeps between school bus seats. Lacquered hardwood block with one threaded handle hole. Use handle #44571 on page 146.

Block Size	Fill Material	Trim Length	Standard Pack	Item Number
10" x 2-1/2"	Flagged Silver-grey Polystyrene	3"	12	70312



70312

P UPHOLSTERY/SPOTTING BRUSH - Shaped plastic handle
Wet & dry cleaning, prespotting, carpet touch-up, etc.

Block Size	Fill Material	Trim Length	Overall Length	No. of Rows	Std. Pack	Item Number
8-1/2" x 2-9/16"	.016 Crimped Polypropylene	5/8"	8-1/2"	8 x 9	12	44307



44307

P SPOKE BRUSH - Ideal for cleaning spokes or confined spaces.

Length of Brush Part	Fill Material	Brush Part	Overall Length	Standard Pack	Item Number
10"	White Tampico	2-7/8" tapered to 1-1/4"	15"	12	44315



44315

P TIRE CLEANING BRUSHES - Foam block - Used for cleaning sidewalls of tires.

Block Size	Fill Material	Trim Length	Overall Length	No. of Rows	Std. Pack	Item No.
8-1/2" x 2-9/16"	.008 Brass	5/8"	8-1/2"	8 x 9	12	99593
7" x 1-9/16"	.008 Brass	5/8"	7"	6 x 8	12	73156



99593



73156

COATED ABRASIVES

NON-WOVEN ABRASIVES

POWER BRUSHES

NYLON BRUSHES

PACKAGED ITEMS

MAINTENANCE

SCRUB BRUSHES



Scrubbing a stainless steel sink.

A broad range of high quality scrub and utility brushes are available from Weiler. From quick cleaning to heavy-duty scrubbing, Weiler's brushes are designed to provide the most effective brushing and cleaning action.

P HAND SCRUB BRUSHES - Heavily filled for heavy-duty scrubbing.

Block Size	Fill Material	Trim Length	Block Type	Standard Pack	Item Number
6"	White Polypropylene	1-1/8"	Iron Style - Plastic	12	44395
7-1/4"	Palmyra	1"	Square - Wood	24	72034 •
8"	White Tampico	1-1/8"	Square - Wood	12	44024
	White Tampico Palmyra	1" 1-1/8"			72058* 44025
8-1/4"	White Tampico	1-1/8"	Square - Wood	12	73111+
9"	White Tampico	1-1/8"	Pointed - Wood	12	44023

* Threaded handle hole

+ Tapered handle hole

• Non-stock product, contact Customer Service for lead times and minimum order quantities.



44395



44024



44023



44026



44434



44692



44391

P DECK SCRUB BRUSHES - Excellent for scrubbing decks or floors. One threaded and one tapered handle hole. Can be used with threaded handle #44018 or tapered handle #44020.

Block Size	Fill Material	Trim Length	No. of Rows	Block Type	Standard Pack	Item Number
9"	Palmyra	2"	5 x 14	Wood	12	44428
	Tampico					44429
10"	Palmyra	2"	6 x 18	Wood	12	44026
	Tampico					44028
	Polypropylene					44434
12"	Palmyra	2"	6 x 20	Wood	12	44027
	Tampico					44029 •
	Polypropylene					44438

• Non-stock product, contact Customer Service for lead times and minimum order quantities.

P BI-LEVEL SCRUB BRUSHES - The bi-level design allows the brush to stay in contact with the surface. Can be used with flow-through handle #44319 or the Perma-Flex handle #44301.

Block Size	Fill Material	Trim Length	Block Type	Standard Pack	Item Number
10"	Stiff Crimped Blue Polypropylene	1-3/4"	Foam	6	44692
10"	Flagged White Polystyrene	2-3/4"	Foam	6	44699
10"	Fine Green Nylex	2-3/4"	Foam	12	44693

V VORTEC PRO® BOOT BRUSH - Reliable and efficient brush at a value price.

Size	Description	Item Number
9" x 6"	Boot Cleaning Brush - Metal Frame - Wood Block - Black Nylon Fill	44391

SCRUB BRUSHES & UTILITY BRUSHES



Removing stubborn dirt, grime and mildew from a tiled surface with a grout detail brush.

P **UTILITY SCRUB BRUSHES** - For general scrubbing in factories, kitchens, institutions, etc.

Overall Length	Fill Material	Trim Length	Block Type	Standard Pack	Item Number
8"	Palmyra	2"	Wood	12	72086
	Yellow Polypropylene				44013
	White Tampico				44014
20"	Palmyra	2"	Wood	12	72101
	Yellow Polypropylene				44016
	White Tampico				44017

P **UTILITY SCRUB BRUSHES** - Chemical and water resistant, will not warp or crack.

Overall Length	Fill Material	Trim Length	Block Type	Standard Pack	Item Number
8"	Palmyra	2"	Foam	12	79101
	Yellow Polypropylene				79120
	White Tampico				79100
20"	Palmyra	2"	Foam	12	79107
	Yellow Polypropylene				79109
	White Tampico				44663

P **UTILITY SCRUB BRUSHES** - Designed for high temperature cleaning, ideal for food service.

Overall Length	Fill Material	Trim Length	Block Type	Standard Pack	Item Number
8"	White Nylon	2"	Plastic	12	44416
20"	White Nylon	2"	Plastic	12	44418

V **VORTEC PRO® UTILITY SCRUB BRUSHES** - Ideal for general purpose cleaning.

Overall Length	Fill Material	Trim Length	Block Type	Standard Pack	Item Number
8"	Tampico	2"	Foam	12	25262
20"	Tampico	2"	Foam	12	25263

P **GROUT DETAIL BRUSH** - Use for removing stubborn dirt, grime and mildew from tiled surfaces.

Block Size	Fill Material	Trim Length	Standard Pack	Item Number
8-1/2"	Stiff Black Nylon	7/8"	24	73233

P **BOWL BRUSH** - 2" Trim Length - For thorough, efficient cleaning.

Brush Part	Fill Material	Handle	Overall Length	Standard Pack	Item Number
5-3/4" x 4-3/4"	Black Nylon	Plastic	21"	12	75068



COATED ABRASIVES
NON-WOVEN ABRASIVES
POWER BRUSHES
NYLON BRUSHES
PACKAGED ITEMS

MAINTENANCE

Key:

- P** Performance line Industrial Grade
- V** Value line Professional Grade



44001

P

PROFESSIONAL BOWL BRUSHES - Hardwood handle and natural fiber - For thorough cleaning.

Brush Part	Fill Material	Diameter	Overall Length	Standard Pack	Item Number
6" x 5"	White Tampico	2"	20"	12	44001*
6-1/2"	Tampico	3-1/4"	23"	12	75060

* Foam handle



75000

V

VORTEC PRO® BOWL BRUSH SET - 2" Trim Length - Reliable and efficient brushes at a value price.

Brush Part	Fill Material	Handle	Overall Length	Standard Pack	Item Number
3-1/2" x 3-3/4"	Polypropylene	Plastic	14-1/2"	6	75000



44314

V

VORTEC PRO NAIL BRUSH - Great for use in shop or industrial settings.

Block Size	Fill Material	Trim Length	No. of Rows	Block Type	Standard Pack	Item Number
4-3/4" x 1-1/2"	Polypropylene	3/4"	4 x 15	Wood	36	44314



99594

P

BOTTLE WASHING BRUSH - Brush shape enables access to hard-to-reach areas when cleaning.

Length of Brush Part	Fill Material	Handle	Overall Length	Standard Pack	Item Number
6"	Black Horsehair	Wood	16"	12	99594



75085

V

VORTEC PRO BOTTLE WASHING BRUSH - Reliable and efficient brush at a value price.

Length of Brush Part	Fill Material	Handle	Overall Length	Standard Pack	Item Number
5-1/2" x 2-3/8"	White Nylon	Twisted-in-wire	17"	24	75085



44111

44115

P

NYLON TUBE BRUSHES - Loop handle, Straight black nylon fill.

Diameter	Fill Diameter	Brush Part	Stem Diameter	Overall Length	Standard Pack	Item Number
1/4"	.005	2"	3/32"	6-1/4"	36	44110
3/8"	.005	2"	3/32"	6-1/4"	36	44213
1/2"	.010	3"	1/8"	8-1/2"	36	44111
3/4"	.012	3"	1/8"	8-1/2"	36	44112
1"	.014	4"	5/32"	12-1/4"	36	44113
1-1/4"	.014	4"	5/32"	13"	36	44114
2"	.014	5"	3/16"	16-3/4"	36	44115



44316

P

PERCOLATOR BRUSH - Straight white nylon fill
Ideal for internal cleaning in industrial, laboratory and food service.

Diameter	Fill Diameter	Brush Part	Stem Diameter	Overall Length	Standard Pack	Item Number
7/16"	.010	3-1/2"	5/32"	11-1/2"	10	44316



75570

P

VAT BRUSH - For valves, outlets, small tanks, beverage dispensers & coffee urns.
Can be used with the Perma-Flex handle #44301.

Fill Material	Block Type	Overall Length	Standard Pack	Item Number
White Nylon	White Nylon	8"	1	75570

WET MOPS & ACCESSORIES

Our wet mops are made with industrial grade cotton and can be laundered. They will not scratch floors or unravel.



Use the Combo Bucket with 12 to 32 oz. mop heads

P **WET MOP HEADS** - Durable, ideal for all-purpose cleaning. Can be laundered.

Weight	Material	Standard Pack	Item Number
Cut End			
16 oz.	8-ply tight twist cotton	12	75102
20 oz.			75103
24 oz.			75104
32 oz.			75105
Small	4-ply high bulk cotton economy	12	75170 •
Medium			75171
Large			75172
X-Large			75173 •
Loop End			
Small	4-ply tight twist cotton	12	75180 •
Medium			75181
Large			75182 •

• Non-stock product, contact Customer Service for lead times and minimum order quantities.



75102



75171

P **WET MOP HANDLES** - Industrial Grade. Hardwood handle with plated metal heads.

Description	Size	Standard Pack	Item Number
Quick-Change Plastic Head	54" x 15/16"	12	75140
Screw Type	54" x 1-1/8"	12	75131
Spring Type	54" x 1-1/8"	12	75132
Jaw Type	54" x 1-1/8"	12	75130



75140

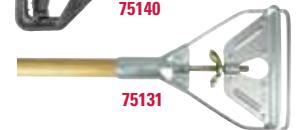

75131

P **ONE-PIECE COTTON DECK MOPS** - Industrial grade. Mop head securely tied to handle.

Description	Weight	Standard Pack	Item Number
#10	10 oz.	12	75096 •
#12	12 oz.	12	75097 •
#16	16 oz.	12	75109
#20	20 oz.	12	75098
#24	24 oz.	12	75110

• Non-stock product, contact Customer Service for lead times and minimum order quantities.



75109

V **VORTEC PRO® COMBO BUCKET** - One-piece construction that will not rust, fade, crack, peel, chip, dent or warp. Wringer fits all sizes of plastic or metal buckets.

Bucket Size	Wringer	Standard Pack	Item Number
36 qt.	12-32 oz.	1	36666



36666

Key:

P Performance line
Industrial Grade

V Value line
Professional Grade

COATED ABRASIVES

NON-WOVEN ABRASIVES

POWER BRUSHES

NYLON BRUSHES

PACKAGED ITEMS

MAINTENANCE

DUST MOPS & DUSTING BRUSHES

Our dust mops are made with industrial grade cotton and can be laundered. They will not scratch floors or unravel.



Cleaning a corner with a dust mop.



75117

P **PROFESSIONAL DUST MOPS** - Tie-on style, 4-ply cotton. Can be laundered.

Mop Size	Frame Size	Standard Pack	Item Number
24"	5" x 24"	12	75117
36"	5" x 36"	12	75118



75138

P **PROFESSIONAL DUST MOP FRAMES** - Heavy-duty full swivel frame.

Mop Size	Frame Size	Standard Pack	Item Number
24"	5" x 24"	12	75137
36"	5" x 36"	12	75138



75133

P **PROFESSIONAL DUST MOP HANDLE** - Heavy-duty clamp-on style.

Length	Diameter	Standard Pack	Item Number
60"	15/16"	12	75133



73050



73055

P **RADIATOR BRUSHES** - 24" Overall Length. Ideal for cleaning radiators and narrow, hard-to-reach places.

Fill Material	Type	Brush Part	Trim Length	Overall Length	Std. Pack	Item No.
Black Horsehair	Foam Handle	9-1/2"	2-1/2"	23-13/16"	12	73050
Black Horsehair	Twisted-in-wire handle	7-1/2"	2-1/2"	24-11/16"	12	73055



71076

P **WALL DUSTING BRUSH** - For dusting ceilings, valances, high moldings and other hard-to-reach places. Twisted-in-wire construction with plastic handle.

Fill Material	Overall Length	Trim Length	Standard Pack	Item Number
Horsehair	12" x 5"	2-3/4"	2	71076

MASONRY & APPLICATOR BRUSHES

Weiler's full line of Masonry & Applicator Brushes covers everything from the ground up - cement finishing and stippling brushes for texturing and applying cement and asphalt; whitewashing and masonry brushes for applying cement, water paints and liquid waterproofing materials on concrete block and masonry walls; smoothing brushes for applying wallpaper; and roof brushes for spreading roofing tar and coatings.



Applying waterproofing material with a masonry brush.

P KNOT-TYPE ROOF BRUSHES - For application of roof coatings.

Can be used with tapered handle #44574.

Block Size	Fill Material	Trim Length	No. of Knots	Standard Pack	Item Number	★ Combo Qty. Item Number
6-1/4"	Tampico	3-1/4"	3	12	44010	44883 •

★ Combo Packs include 12 brushes per pack and 12 #44574 handles (not assembled).

• Non-stock product, contact Customer Service for lead times and minimum order quantities.



44010

P BLOCK-TYPE ROOF BRUSHES - For application of roof coatings.

Can be used with tapered handle #44574 or threaded handle #75527.

Block Size	Fill Material	Trim Length	No. of Knots	Standard Pack	Item Number	★ Combo Qty. Item Number
7"	White Tampico One tapered handle hole	2"	5	12	44011	44884 •
7"	White Tampico One threaded handle hole	2"	5	12	73195	—

★ Combo Packs include 12 brushes per pack and 12 #44574 handles (not assembled).

• Non-stock product, contact Customer Service for lead times and minimum order quantities.



44011

P MASONRY BRUSHES -

Useful tools for applying cement, waterpaints and liquid waterproofing materials on masonry walls. Handle attached.

Block Size	Fill Material	Trim Length	Overall Length	No. of Rows	Standard Pack	Item Number
7"	White Tampico	3-1/4"	11"	2	12	44032
6"	Solvent Resistant Polypropylene	3-1/4"	11-1/2"	3	12	74020
4"	White Tampico	3"	10-3/4"	4	12	74004
6-1/2"	White Tampico	3-1/2"		4		44031
6"	White Tampico	3"	10-1/2"	5	12	74002
6-1/2"	White Tampico	4"	11-3/4"	5		44448



44031



44448

P WHITWASH BRUSHES - Two tapered handle holes allow user to choose the correct brush angle needed.

Can be used with tapered handle #75528.

Block Size	Fill Material	Trim Length	No. of Rows	Standard Pack	Item Number
6"	White Tampico	2-5/8"	2	12	74048
7"	White Tampico	2-5/8"	2	12	44034 74053*

* Includes a 12" tapered wood handle.



44034

Key:

P Performance line
Industrial Grade

V Value line
Professional Grade

COATED ABRASIVES

NON-WOVEN ABRASIVES

POWER BRUSHES

NYLON BRUSHES

PACKAGED ITEMS

MAINTENANCE



74015

P **ACID BRUSH - Detachable handle** - For the application of Kalsomine, cold water, acid and water repellents to concrete and other rough surfaces.

Block Size	Fill Material	Trim Length	No. of Rows	Standard Pack	Item Number
7"	White Tampico	3-1/2"	3	12	74015



73111

P **ACID SCRUB BRUSH - Hardwood block** - Tapered handle hole
Recommended for applying sealcoating, cement slurry, water-proofing, etc.

Block Size	Fill Material	Trim Length	Standard Pack	Item Number
8-1/4" x 2-3/4"	White Tampico	1-1/8"	12	73111

NOTE: Handle not included - can be used with tapered handle #44574.



79251

P **CEMENT FINISHING BRUSHES - Hardwood block** - Ideal for creating texture to newly poured cement and for applying coatings on asphalt or concrete. Use handle #44303.

Block Length	Fill Material	Trim Length	No. of Knots	Standard Pack	Item Number	★ Combo Qty. Item Number
24"	Black Polypropylene	2-1/4"	3	6	79251	-
24"	Black Polypropylene	3-1/4"	3	6	79252	44879 •
36"	Black Polypropylene	3-1/4"	3	6	79253	44880 •
24"	Horsehair	2-1/2"	3	6	79255 •	44881 •
36"	Horsehair	2-1/2"	3	6	79256 •	44882 •

★ Combo Packs include 12 brushes per pack and 12 #44303 handles (not assembled).

• Non-stock product, contact Customer Service for lead times and minimum order quantities.



74078

P **SMOOTHING BRUSH - Hardwood block** - For smoothing wallpaper.

Block Length	Fill Material	Trim Length	Standard Pack	Item Number
12"	White Tampico	2"	12	74078

Creating texture on newly poured concrete with a cement finishing brush.



Key:

P Performance line
Industrial Grade

V Value line
Professional Grade

SCRATCH BRUSHES

Weiler's extensive Scratch Brush offering includes many block and handle types and sizes. The wide variety of fill materials available assures the right brush for the right job. Common applications are cleaning dirt, rust, scale, chips and paint; plating and welding operations.



Removing excess concrete from the surface of a steel support plate.

P CURVED HANDLE SCRATCH BRUSHES - **Hardwood block** - Ideal for cleaning and prepping surfaces.

Block Size	Brush Length	Number of Rows	Trim Length	Standard Pack	Item Number
.012 Steel Wire					
13-3/4" x 1-1/8"	5-1/4"	3 x 14	1-1/4"	12	44594*
14" x 7/8"	5-1/2"	3 x 19	1-3/16"	12	44053
14" x 1-1/8"	6"	4 x 18	1-3/16"	12	44056
.012 Steel Wire with Scraper					
14" x 7/8"	5-1/2"	3 x 19	1-3/16"	12	44055
14" x 1-1/8"	6"	4 x 18	1-3/16"	12	44058
.012 Stainless Steel Wire					
13-3/4" x 1-1/8"	5-1/4"	3 x 14	1-1/4"	12	44432*
14" x 7/8"	5-1/2"	3 x 19	1-3/16"	12	44054
14" x 1-1/8"	6"	4 x 18	1-3/16"	12	44057

* V-Groove



V VORTEC PRO® CURVED HANDLE SCRATCH BRUSHES -

Reliable and efficient brushes at a value price.

Block Size	Brush Length	Number of Rows	Trim Length	Standard Pack	Item Number
.012 Steel Wire					
13-1/2" x 1"	6"	3 x 19	1"	12	25150
14" x 1-1/8"	6"	4 x 18	1"	12	25201
.012 Stainless Steel Wire					
13-1/2" x 1"	6"	3 x 19	1"	12	25154
14" x 1-1/8"	6"	4 x 18	1"	12	25202



P SHOE HANDLE SCRATCH BRUSHES - **Hardwood block** - Ideal for cleaning and prepping surfaces.

Block Size	Brush Length	Number of Rows	Trim Length	Standard Pack	Item Number
.012 Steel Wire					
10" x 3/8"	5"	1 x 17	1-1/16"	12	44100
10" x 5/8"	5"	2 x 17	1-3/16"	12	44061
10" x 1-1/8"	5"	4 x 16	1-3/16"	12	44063
11"	5"	4 x 16	1-3/16"	12	73217 •
.012 Steel Wire with Scraper					
10" x 1-1/8"	5"	4 x 16	1-3/16"	12	44065
.012 Stainless Steel Wire					
10" x 3/8"	5"	1 x 17	1-1/16"	12	44101
10" x 3/8"	5"	1 x 17	3/4"	12	44235
10" x 5/8"	5"	2 x 17	1-3/16"	12	44062
10" x 1-1/8"	5"	4 x 16	1-3/16"	12	44064
11"	5"	4 x 16	1-3/16"	12	44299 •
.012 Brass Wire					
11"	5"	4 x 16	1-1/4"	12	73218 •

• Plastic block



V VORTEC PRO SHOE HANDLE SCRATCH BRUSHES -

Reliable and efficient brushes at a value price.

Block Size	Brush Length	Number of Rows	Trim Length	Standard Pack	Item Number
.012 Steel Wire					
10" x 1"	5"	4 x 16	1"	12	25100
.012 Stainless Steel Wire					
10" x 1"	5"	4 x 16	1"	12	25104



COATED ABRASIVES

NON-WOVEN ABRASIVES

POWER BRUSHES

NYLON BRUSHES

PACKAGED ITEMS

MAINTENANCE



P HEAVY-DUTY SCRATCH BRUSH WITH SCRAPER - .012 Steel Wire

Ideal for cleaning and prepping surfaces.

Block Size	Brush Length	Number of Rows	Trim Length	Standard Pack	Item Number
11-1/2" x 1-1/2"	5-1/2"	4 x 11	1-1/2"	12	44069

V VORTEC PRO® HEAVY-DUTY SCRATCH BRUSH WITH SCRAPER - .012 Steel Wire

Reliable and efficient brushes at a value price.

Block Size	Brush Length	Number of Rows	Trim Length	Standard Pack	Item Number
11-1/2" x 1-1/2"	5"	4 x 11	1-5/8"	12	25211

P PLATER'S BRUSHES - Hardwood block - For general cleaning in the plating, metal finishing, aircraft and missile industries. Also used with inert arc aluminum welding.

Block Size	Brush Length	Number of Rows	Trim Length	Standard Pack	Item Number
Tampico					
13" x 1-1/4"	5-1/4"	4 x 18	1"	12	44076
Nylon					
13" x 1-1/8"	5-1/4"	4 x 18	1"	12	44077
.006 Steel Wire					
10" x 1-1/8"	5"	4 x 16	1"	12	44117 •
13" x 7/8"	5-1/2"	3 x 19	1"	12	44116
.006 Stainless Steel Wire					
10" x 1-1/8"	5"	4 x 18	1"	12	44240
13" x 7/8"	5-1/2"	3 x 19	1"	12	44660
13" x 1-1/8"	5-1/2"	4 x 19	1"	12	44232
.006 Brass Wire					
10" x 1-1/8"	5"	4 x 18	1"	12	44119
13" x 7/8"	5-1/2"	3 x 19	1"	12	44118

• Non-stock product, contact Customer Service for lead times and minimum order quantities.



P SMALL HAND SCRATCH BRUSHES - Ideal for cleaning and prepping surfaces.

Block Size	Block	Number of Rows	Wire Size	Trim Length	Standard Pack	Item Number
Stainless Steel Wire						
7-1/2" x 1/2"	Plastic	3 x 7	.006	1/2"	36	44075 ■
7-1/2" x 1/2"	Wood	3 x 7	.006	1/2"	36	44167 ■ +
7-3/4" x 3/8"	Wood	3 x 7	.006	1/2"	36	44551 *
8-3/4" x 1/2"	Wood	2 x 9	.006	5/8"	36	95013
Straight Brass Wire						
7-1/2" x 1/2"	Wood	3 x 7	.006	1/2"	36	44189 ■
Crimped Brass Wire						
6" x 1/2"	Wood	3 x 10	.005	5/8"	72	44619
8-3/4" x 1/2"	Wood	2 x 9	.008	5/8"	36	95014
Crimped Aluminum						
6-3/4" x 1-5/8"	Wood	6 x 9	.008	5/8"	12	95151
8-3/4" x 1/2"	Wood	2 x 9	.008	5/8"	36	44251
Straight Black Nylon						
6-1/2" x 1/2"	Plastic	4 x 15	.010	1/2"	24	99383
7-1/2" x 1/2"	Wood	3 x 7	.012	1/2"	36	44637 ■
White Nylon						
7-1/2" x 1/2"	Plastic	3 x 7	.016	1/2"	36	44609
Double-Sided Brass/White Nylon						
7-1/2" x 1/2"	Plastic	3 x 7	.006/.016	1/2"	24	44731
Double-Sided Brass/Stainless Steel						
7-1/2" x 1/2"	Plastic	3 x 7	.006/.006	1/2"	24	44732
Double-Sided Stainless Steel/White Nylon						
7-1/2" x 1/2"	Plastic	3 x 7	.006/.016	1/2"	24	44733

+Countertop display available. See page 143 for details. ■ Packaged product available. See pages 141-142 for details.

*Wire drawn



Key:

P Performance line
Industrial Grade

V Value line
Professional Grade

V **VORTEC PRO® SMALL HAND SCRATCH BRUSHES** - Reliable and efficient brushes at a value price.

Block Size	Handle	Number of Rows	Trim Length	Standard Pack	Item Number
.006 Stainless Steel Wire					
7-1/2" x 1/2"	Wood	3 x 7	1/2"	36	44805
7-1/2" x 1/2"	Plastic	3 x 7	1/2"	36	44806
.006 Straight Brass Wire					
7-1/2" x 1/2"	Wood	3 x 7	1/2"	36	44810



P **BLOCK TYPE SCRATCH BRUSHES** - For rugged cleaning on bricks, stone and similar large flat areas.

Block Size	Fill Material	Brush Part	Number of Rows	Trim Length	Standard Pack	Item Number
7-1/4" x 2-5/8"	.012 Round Wire - Curved Face	7"	9 x 21	1-3/16"	12	44066
7-1/4" x 2-1/4"	.014 Round Wire - Flat Face	7"	6 x 19	1-5/8"	12	44067



V **VORTEC PRO BLOCK TYPE SCRATCH BRUSH** - Reliable and efficient brushes at a value price.

Block Size	Fill Material	Brush Part	Number of Rows	Trim Length	Standard Pack	Item Number
7-1/4" x 2-1/4"	.012 Steel	7"	6 x 19	1-5/8"	12	25212



P **CHIPPING HAMMER REFILL** - A refill brush for most chipping hammers. Used for weld cleaning.

Block Size	Fill Material	Brush Part	Number of Rows	Trim Length	Standard Pack	Item Number
4-5/8" x 7/8"	.012 Steel	4-1/2"	3 x 15	1-1/8"	12	44070



P **WIRE DUSTER** - For cleaning chips, borings, solder, rust, dirt & corrosion from castings.

Block Size	Fill Material	Handle Length	Number of Rows	Trim Length	Standard Pack	Item Number
3" x 1-1/8"	.012 Steel	5-3/4"	4 x 8	2-1/2"	12	44451



P **FILE CARD BRUSH** - Waxed hardwood block. Use for file cleaning or to roughen and prepare surface material prior to sweating and soldering.

Overall Length	Fill Material	Brush Part	Trim Length	Standard Pack	Item Number
8-1/4"	.012 Steel	1-5/8" x 4"	1/4"	12	44260



P **METAL CHIP BRUSH** - Small stiff wire brush for brushing hot metal. Can be exposed to flames without burning.

Overall Length	Fill Material	Trim Length	Face Width	Standard Pack	Item Number
5-1/2"	.012 Steel	1-1/2"	1-1/4"	12	44074



WHY WEILER BONDED ABRASIVES COATED ABRASIVES NON-WOVEN ABRASIVES POWER BRUSHES NYLON BRUSHES PACKAGED ITEMS MAINTENANCE

FLUE BRUSHES

Flue Brushes are designed and engineered from black oil-tempered wire. Flue brushes are available in single spiral and double spiral construction. Other fill materials and sizes available by special order. Contact Customer Service for details.

APPLICATIONS

Provides increased conformability and long life when:

- Pipe cleaning
- Flue cleaning
- Boiler tube cleaning



Cleaning boiler pipes with a flue brush.

P **FLUE BRUSHES** - Filled with .012 round wire and fitted with 1/4" x 2" NPT pipe nipple. For internal cleaning of pipes and flues.

Brush Diameter	Brush Length	Overall Length	Standard Pack	Item Number
Single Spiral				
7/8"	4-1/2"	7-1/2"	1	44124 •
1"	4-1/2"	7-1/2"	1	44125
1-1/4"	4-1/2"	7-1/2"	1	44047
1-1/2"	4-1/2"	7-1/2"	1	44128
1-3/4"	4-1/2"	7-1/2"	1	44048
2"	4-1/2"	7-1/2"	1	44131
2-1/2"	4-1/2"	7-1/2"	1	44133
3"	4-1/2"	7-1/2"	1	44135
3-1/2"	4-1/2"	7-1/2"	1	44137
4"	4-1/2"	7-1/2"	1	44139
Double Spiral				
1"	4-1/2"	7-1/2"	1	44149
1-1/4"	4-1/2"	7-1/2"	1	44035
1-1/2"	4-1/2"	7-1/2"	1	44150
1-3/4"	4-1/2"	7-1/2"	1	44036
2"	4-1/2"	7-1/2"	1	44152
2-1/4"	4-1/2"	7-1/2"	1	44037
2-1/2"	4-1/2"	7-1/2"	1	44154
2-3/4"	4-1/2"	7-1/2"	1	44038
3"	4-1/2"	7-1/2"	1	44156
4"	4-1/2"	7-1/2"	1	44169
4-7/8"	4-1/2"	7-1/2"	1	44159

• Non-stock product, contact Customer Service for lead times and minimum order quantities.



44131



44154



95925

P **FLUE BRUSH EXTENSION ROD** - One 1/4" male pipe nipple and one 1/4" female pipe coupling allows user to extend flue brush.

Description	Standard Pack	Item Number
36" Fiberglass Extension Rod	1	95925

NOTE

"Pipeline" Flue Brushes By Special Order Only.

- Heavy-duty. Exact size diameter. Rugged double stem, single spiral.
- Fitted with 1/4" pipe nipple. Available in diameters of 1-5/8" - 15".

Key:

P Performance line
Industrial Grade

V Value line
Professional Grade

TUBE FITTING BRUSHES

Several configurations and sizes of Tube Fitting Brushes are available for cleaning and deburring copper, internal and external tube fittings. The handy 4-in-1 tube fitting brush cleans both outside and inside diameters of multiple tube sizes.



Cleaning the inside of a copper fitting prior to soldering.

P INTERNAL TUBE FITTING BRUSHES - Wire Fill - For internal cleaning and deburring of copper tube fittings. Also used in trucking and marine industries as a light socket cleaning brush.

Pipe Size	Actual Brush Diameter	Brush Length	Overall Length	Handle Length	Standard Pack	Item Number
1/8"	1/4"	1"	6-1/2"	3-1/4"	12	44078
1/4"	3/8"	1"	6-1/2"	3-1/4"	12	44079
3/8"	1/2"	1"	6-1/2"	3-1/4"	12	44080 ■
1/2"	5/8"	1"	6-1/2"	3-1/4"	12	44081
5/8"	3/4"	1"	6-1/2"	3-1/4"	12	44082
3/4"	7/8"	1"	6-1/2"	3-1/4"	12	44083
7/8"	1"	1"	6-1/2"	3-1/4"	12	44084
1"	1-1/8"	1"	6-1/2"	3-1/4"	12	44085
1-1/4"	1-3/8"	1"	6-1/2"	3-1/4"	12	44086
1-1/2"	1-5/8"	1-1/2"	6-1/2"	3-1/4"	6	44087

■ Packaged product available. See pages 141-142 for details.



44079

P EXTERNAL TUBE FITTING BRUSHES - 1/4" Stem

Ideal for cleaning tube ends. Mount to a hand drill for fast results.

Outside Diameter	Standard Pack	Item Number
3/8"	40	44734 •
1/2"	40	44735 •
5/8"	40	44736 •
3/4"	40	44737 •
7/8"	40	44738 •
1"	40	44739 •

• Non-stock product, contact Customer Service for lead times and minimum order quantities.



44734

P 4-IN-1 TUBE FITTING BRUSH - ONE BRUSH REPLACES FOUR! - Steel Wire

Cleans the outside and inside diameters of 1/2" and 3/4" tubes and fittings. Use for soldering prep, deburring, drill hole cleaning and cleaning battery terminals.

Tube Inside Diameter	Tube Outside Diameter	Standard Pack	Item Number
3/4" and 1/2"	7/8" and 5/8"	1	44690



44690

TURBO TUBE™ BRUSHING TOOL - The Turbo Tube Brushing Tool is two brushes in one, so fittings and copper tubing can be easily cleaned without changing tools!

APPLICATIONS

- Fitting brush cleans outside diameter
- Tube brush cleans inside diameter
- Ideal for plumbing and HVAC projects

V VORTEC PRO® TURBO TUBE BRUSHES - Clean I.D. and O.D. with the same tool. Rust-proof stainless steel bristles. Reliable and efficient brushes at a value price.

I.D. Size	O.D. Size	Wire Type	Max. RPM	Standard Pack	Item Number
1/2"	5/8"	Stainless	1,000	1	36303
3/4"	7/8"				36304
1"	1-1/8"				36305



36305



COATED ABRASIVES

NON-WOVEN ABRASIVES

POWER BRUSHES

NYLON BRUSHES

PACKAGED ITEMS

MAINTENANCE

SELECTING THE RIGHT BRUSH

P PERFORMANCE LINE (INDUSTRIAL GRADE)

Engineered and manufactured to maximize performance and minimize operating costs. The use of superior construction, the highest quality materials and the most stringent manufacturing processes deliver the lowest cost-of-use and most consistent performance.

V VALUE LINE (PROFESSIONAL GRADE)

Weiler's value line is manufactured using similar product construction and the same exacting standards as other Weiler paint & varnish products, but engineered to provide cost-effective use specifically designed for the professional, providing a cost-effective price. Vortec Pro® paint & varnish products are an economical choice for the construction trades, low volume production shops and light-duty industrial MRO use.

SELECTION GUIDE

Brush Fill	Recommended For	Benefits
China Bristle	All oil based and alkyd paints, stains, varnish urethane & shellac	<ul style="list-style-type: none"> • Softest tip for fewest brush marks • Natural fibers hold paint better than synthetics
Polyester/Nylon blend	All paints and coatings	<ul style="list-style-type: none"> • Most durable material • Precise tipping • Cleans up easily
Polyester	All paints and coatings	<ul style="list-style-type: none"> • Low cost • Does not absorb water

PAINT BRUSH FEATURES

Fill Material:

- Natural China Bristle or Tapered Polyester
- Various sizes of fill material are blended together to create the proper taper.

Flagged Ends:

A split at the end of each tapered fiber of fill material. Bristle is naturally tapered with a flagged tip. Polyester fibers are made tapered and then mechanically processed to form a flagged tip. Flagging allows each tip to pick up more paint and spread it more evenly.

Thickness: The thickness of the brush, measured at the ferrule, will determine the quality level of the brush. The thicker the brush, the more paint pick-up and release.

Ferrule: The metal band that holds the fill material and handle together. All Weiler paint and varnish brushes are made with plated metal ferrules that will not rust or corrode.

Handle:

- Quality wood or synthetic
- Handles are sanded and lacquered
- Synthetic handles are not affected by paints, varnishes or solvents.
- Comfortable grip for hours of fatigue-free use.

Trim Length: The length of the fill material extending from the ferrule. The longer the trim, the more paint is picked up and released for a quicker, easier job.



PAINT BRUSH CARE

Brushes Used In	Clean With
<ul style="list-style-type: none"> • Oil base paint • Latex paint • Water base paint • Varnish • Shellac 	<ul style="list-style-type: none"> • Turpentine or mineral spirits • Warm soapy water • Warm soapy water • Turpentine or mineral spirits • Alcohol

Note: After cleaning, shake out, comb bristles and hang by handle.

SPECIAL PAINT BRUSHES

The brushes listed in this catalog will cover the major requirements of industry. However, if an application requires another type, size or style of brush, contact your nearest Weiler distributor or Weiler's Customer Experience Team.

PROFESSIONAL PAINT, VARNISH & SASH BRUSHES

These high quality brushes are available in a wide variety of sizes and materials to fill all applications. The Professional Wall Brushes have a sanded wooden handle, the preferred standard among professional users. The Professional Varnish and Sash Brushes are color coded - Blue for Bristle and Red for Polyester/Nylon Blend, and feature painted foam handles in the "beaver tail" style. These handles are attractive and easier to grip, reducing user fatigue.



Applying paint to clap board siding.

P WALL PAINT BRUSHES - For interior/exterior painting of large flat surfaces.

Width	Thickness	Bristle Length	Overall Length	Standard Pack	Item Number
Black China Bristle - Sanded Wood Handle					
3"	7/8"	3-1/4"	10-3/16"	6	40022
4"	7/8"	3-3/4"	11-1/2"	6	40023
Polystyrene/Nylon - Sanded Wood Handle					
3"	7/8"	3"	10-1/8"	6	40061
4"	7/8"	3"	11-1/4"	6	40062



P VARNISH BRUSHES - Comfortable foam grip handle; smooth paint flow.

Width	Thickness	Bristle Length	Overall Length	Standard Pack	Item Number
Black China Bristle - Blue Foam Handle					
1"	7/16"	2"	8-1/2"	12	40000
1-1/2"	1/2"	2-1/4"	8-7/8"	12	40001
2"	9/16"	3"	9-3/4"	12	40002
3"	11/16"	3"	10-1/8"	12	40004
4"	11/16"	3"	10-9/16"	12	40010
Polystyrene/Nylon - Red Foam Handle					
1"	7/16"	2-1/4"	8-13/16"	12	40058
2"	3/4"	2-3/4"	9-15/16"	12	40059
3"	7/8"	3"	10-1/8"	12	40060
4"	7/8"	3"	11"	6	40106



P ANGLED SASH BRUSHES - For trim or cut work like window sills, door frames, etc.

Width	Thickness	Bristle Length	Overall Length	Standard Pack	Item Number
Black China Bristle - Blue Foam Handle					
1-1/2"	7/16"	2-1/4"	10-7/8"	12	40041
2"	1/2"	2-1/4"	10-3/4"	12	40008
Polystyrene/Nylon - Red Foam Handle					
1-1/2"	7/16"	2-1/2"	11-1/4"	12	40011
2"	1/2"	2-1/2"	11-1/8"	12	40040

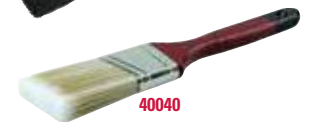

P FLAT SASH BRUSHES - For trim or cut work like window sills, door frames, or other narrow, flat surfaces.

Width	Thickness	Bristle Length	Overall Length	Standard Pack	Item Number
Black China Bristle - Blue Foam Handle					
1"	3/8"	2"	10-3/8"	12	40113
1-1/2"	7/16"	2-1/4"	10-1/2"	12	40114 •
2"	9/16"	3"	11-15/16"	12	40115
Polystyrene/Nylon - Red Foam Handle					
1"	3/8"	2-1/4"	10-1/4"	12	40014 •
1-1/2"	7/16"	2-1/4"	10-1/2"	12	40017
2"	9/16"	2-1/2"	10-15/16"	12	40018



• Non-stock product, contact Customer Service for lead times and minimum order quantities.

COATED ABRASIVES

NON-WOVEN ABRASIVES

POWER BRUSHES

NYLON BRUSHES

PACKAGED ITEMS

MAINTENANCE

PROFESSIONAL SASH & PARTS CLEANING BRUSHES



Cleaning an oil pan with a parts cleaning brush.

These high quality brushes are available in a wide variety of sizes and materials to fill all applications. The Professional Sash Brushes are color coded - Blue for Bristle and Red for Polyester/Nylon Blend, and feature painted foam handles in the "beaver tail" style. These handles are attractive and easier to grip, reducing user fatigue. Parts cleaning brushes are ideal for applications such as cleaning carburetors, transmission components, applying adhesives and lubricants.



40056

P OVAL SASH BRUSHES - Ideal for cleaning parts, crevices and painting hard-to-reach areas.

Size	Thickness	Bristle Length	Overall Length	Standard Pack	Item Number
Black China Bristle - Plain Foam Handle - Chisel Trim					
#2	7/16"	1-3/4"	8-7/8"	24	40116
#4	11/16"	1-3/4"	8-5/8"	12	40019
#6	13/16"	1-3/4"	9-5/16"	12	40056
#8	15/16"	3"	11-1/8"	12	40020
#10	1-1/16"	3"	11-3/16"	12	40021



40121

P ROUND SASH BRUSHES - Ideal for cleaning parts, crevices and painting hard-to-reach areas.

Size	Thickness	Bristle Length	Overall Length	Standard Pack	Item Number
Grey Bristle - Plain Foam Handle - Flat Trim					
#2	7/16"	1-3/4"	8-3/4"	24	40118
#4	11/16"	2"	8-13/16"	12	40119
#6	13/16"	2"	10-1/16"	12	40120 •
#8	15/16"	2-1/4"	10-9/16"	12	40121
#10	1-1/16"	2-1/4"	10-9/16"	12	40122 •

• Non-stock product, contact Customer Service for lead times and minimum order quantities.



40035

P PARTS CLEANING BRUSHES - Stainless steel ferrule - Heavily filled.

Thickness	Fill Material	Bristle Length	Overall Length	Standard Pack	Item Number
Plain Foam Handle - Chisel Trim					
1"	Polypropylene	2-1/2"	10-11/16"	12	40035
1"	Tampico	2-3/4"	11-1/8"	12	40036



25222

V VORTEC PRO® PARTS CLEANING BRUSHES - Reliable and efficient brushes at a value price.

Thickness	Fill Material	Bristle Length	Overall Length	Standard Pack	Item Number
Plain Foam Handle - Chisel Trim					
15/16"	Nylon	2-1/2"	11-3/16"	12	25221
1"	Tampico	2-3/4"	11-3/8"	12	25222

INDUSTRIAL PAINT BRUSHES

The Industrial paint brush line features color coded plastic handles to provide quality paint brushes at competitive prices.



Painting inside the fins of a radiator with a Radiator brush.

P INDUSTRIAL VARNISH BRUSHES - Heavily-filled brush with comfortable handle in a variety of sizes.

Width	Thickness	Bristle Length	Overall Length	Standard Pack	Item Number
Black Bristle - Black Plastic Handle					
1"	3/8"	1-3/4"	7-3/4"	36	40089
1-1/2"	7/16"	2"	8-5/16"	24	40101
2"	7/16"	1-3/4"	8"	12	40074
3"	1/2"	2"	8-13/16"	12	40103
4"	5/8"	2-3/4"	9-7/8"	12	40104
Black Polyester - Red Plastic Handle					
1"	3/8"	2"	8"	36	40107
1-1/2"	7/16"	2"	7-11/16"	24	40108
2"	7/16"	2"	8-1/2"	12	40109
3"	1/2"	2"	9-1/4"	12	40110
4"	11/16"	2-3/4"	9-7/8"	12	40111



40074



40109

P BENT RADIATOR BRUSH - Ideal for painting radiators and other hard-to-reach areas.

Width	Thickness	Bristle Length	Overall Length	Standard Pack	Item Number
Black Bristle - Wood Handle					
2"	9/16"	2-1/4"	19-1/2"	12	95502



95502

V VORTEC PRO® FOAM APPLICATOR BRUSHES - Reliable and efficient brushes at a value price.

Not recommended for use with lacquer, shellac or solvents.

Width	Thickness	Foam Length	Overall Length	Standard Pack	Item Number
Wood Handle					
1"	5/8"	2-5/8"	6-3/8"	50	99801
2"	5/8"	2-5/8"	6-1/2"	50	99805
3"	7/16"	2-5/8"	6-1/2"	40	99806

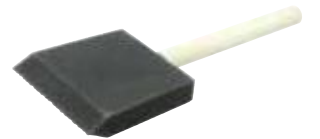

99806

Key:

P Performance line
Industrial Grade

V Value line
Professional Grade

COATED ABRASIVES

NON-WOVEN ABRASIVES

POWER BRUSHES

NYLON BRUSHES

PACKAGED ITEMS

MAINTENANCE

CHIP AND OIL BRUSHES



Removing chips from the ways of a lathe.

Chip and Oil brushes are inexpensive, multi-purpose brushes for use in applications requiring disposable brushes.

P CHIP AND OIL BRUSHES

Width	Thickness	Bristle Length	Overall Length	Standard Pack	Item Number
White Bristle - Wood Handle					
1/2"	5/16"	1-1/2"	7-3/16"	30	40065
1"	5/16"	1-1/2"	7"	30	40066
1-1/2"	5/16"	1-1/2"	7-7/8"	30	40067
2"	5/16"	1-1/2"	7-5/8"	20	40068
2-1/2"	3/8"	1-1/2"	7-3/4"	20	40069
3"	3/8"	1-1/2"	7-7/8"	10	40070
4"	5/8"	1-5/8"	8-9/16"	10	40071
	3/8"	2"	8-7/8"		40076

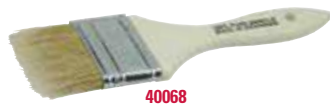

V VORTEC PRO® CHIP AND OIL BRUSHES - Reliable and efficient brushes at a value price.

Width	Thickness	Bristle Length	Overall Length	Standard Pack	Item Number
White Bristle - Wood Handle					
1/2"	5/16"	1-1/2"	7-3/16"	36	40177
1"	5/16"	1-1/2"	7-3/16"	36	40179
1-1/2"	5/16"	1-1/2"	7-1/16"	24	40180
2"	5/16"	1-1/2"	7-5/8"	24	40181
2-1/2"	3/8"	1-1/2"	7-15/16"	12	40182
3"	3/8"	1-1/2"	8-1/4"	12	40183
4"	5/8"	1-3/4"	8-3/4"	12	40184
4"	3/8"	1-3/4"	8-1/2"	12	40185
Black Bristle - Plastic Handle					
1/2"	1/4"	1-5/8"	7-1/8"	30	40160
1"	5/16"	1-5/8"	7-5/16"	30	40161
1-1/2"	5/16"	1-5/8"	7-3/8"	30	40162
2"	5/16"	1-5/8"	7-3/4"	20	40163
2-1/2"	3/8"	1-3/4"	7-3/4"	20	40164
3"	3/8"	1-3/4"	7-15/16"	10	40165
4"	11/16"	2"	8-1/2"	10	40166
Grey China Bristle - Plastic Handle					
1/2"	1/4"	1-1/2"	7-1/8"	48	40026
1"	5/16"	1-1/2"	7-5/8"	36	40027
1-1/2"	5/16"	1-1/2"	7-5/8"	24	40028
2"	3/8"	1-1/2"	7-7/8"	24	40029
2-1/2"	1/2"	1-1/2"	8-5/16"	12	40030
3"	1/2"	1-1/2"	8-9/16"	12	40031
4"	11/16"	1-1/2"	8-13/16"	12	40032
Black Polypropylene - Red Plastic Handle					
1"	5/16"	1-3/4"	7-9/16"	36	40137
2"	3/8"	1-3/4"	7-15/16"	24	40139
3"	1/2"	1-3/4"	9-3/16"	12	40140
4"	11/16"	2-3/4"	9-5/8"	12	40141



Key:

P Performance line
Industrial Grade

V Value line
Professional Grade

MARKING BRUSHES

Weiler's high quality Marking Brushes come in a variety of animal, natural and synthetic bristles in numerous handle styles for many applications such as fine artwork, pin striping and sign painting.



Painting a tight area on a steel door with a Marking Brush.

P RED SABLE WATERCOLOR BRUSHES - Seamless ferrule. Pointed tip - Round black handle

Size	Diameter	Trim Length	Overall Length	Standard Pack	Item Number
3/0	3/64"	1/4"	7"	12	41000
0	1/16"	5/16"	7-1/4"	12	41001
2	3/32"	7/16"	7-3/8"	12	41002
4	1/8"	5/8"	7-5/8"	12	41003



P BLACK BRISTLE MARKING BRUSHES - Long, lacquered handle

Size	Diameter	Trim Length	Overall Length	Standard Pack	Item Number
1	1/8"	3/4"	11-7/8"	12	41004
2	5/32"	15/16"	12"	12	41005
4	7/32"	1-1/8"	12-1/2"	12	41007
5	1/4"	1-1/4"	12-1/2"	12	41008
6	9/32"	1-3/8"	12-3/4"	12	41009



P FLAT MARKING BRUSHES - Ox hair - Single stroke - Round black handle

Width	Trim Length	Overall Length	Standard Pack	Item Number
1/4"	7/8"	7-7/8"	12	41018
1/2"	1"	8-3/4"	12	41019
3/4"	1-1/4"	8-3/4"	12	41020
1"	1-3/8"	9-3/8"	12	41021



P FITCH BRUSHES - Black china bristle - Chiseled edge - Clear lacquered handle

Width	Trim Length	Overall Length	Standard Pack	Item Number
1/4"	13/16"	12"	12	41022
1/2"	1-1/16"	12-3/8"	12	41023
3/4"	1-5/16"	12-7/8"	12	41024 •
1"	1-9/16"	13"	12	41025 •



• Non-stock product, contact Customer Service for lead times and minimum order quantities.

P LACQUERING BRUSHES - Seamless aluminum ferrule - Camel hair - Round black handle

Size	Diameter	Trim Length	Overall Length	Standard Pack	Item Number
1	5/32"	11/16"	7-1/2"	12	41010
3	7/32"	13/16"	8"	12	41011
5	1/4"	1-1/8"	8-3/4"	12	41012 •
6	5/16"	1-3/16"	8-7/8"	12	41013 •



• Non-stock product, contact Customer Service for lead times and minimum order quantities.

COATED ABRASIVES

NON-WOVEN ABRASIVES

POWER BRUSHES

NYLON BRUSHES

PACKAGED ITEMS

MAINTENANCE

GLUE AND ACID BRUSHES

Weiler's Glue and Acid Brushes come in multiple sizes, ferrule types, handles and fill materials for a wide variety of cleaning and coating applications.



Applying flux to a copper tube prior to soldering.



P **BRIDLED GLUE BRUSHES** - Grey china bristle - Steel ferrule - Long foam handle

Diameter	Trim Length	Overall Length	Standard Pack	Item Number
7/16"	1-7/16"	8-1/4"	36	40077
13/16"	1-3/4"	9-3/8"	24	40078 •

• Non-stock product, contact Customer Service for lead times and minimum order quantities.



P **ACID/FLUX BRUSHES** - Horsehair - Tin ferrule

Width	Trim Length	Overall Length	Standard Pack	Item Number
5/16"	3/4"	5-3/4"	144	44088 ■
3/8"	3/4"	5-3/4"	144	44089 ■
1/2"	3/4"	5-3/4"	144	44090 ■

■ Packaged product available. See pages 141-142 for details.



P **STYLUS BRUSH** - Stiff grey horsehair - Aluminum tube with cork to hold cleaning fluid. For cleaning electrical contact points.

Width	Trim Length	Overall Length	Standard Pack	Item Number
1/2"	3/8"	5"	100	44097



P **STENCIL BRUSHES** - China bristle - Seamless steel ferrule - Lacquered wood handle

Diameter	Bristle Length	Overall Length	Standard Pack	Item Number
1"	1-3/8"	5-1/2"	12	40080
2"	1-3/4"	6-3/8"	12	40082



P **DOPE BRUSHES** - With hanger for coating applications in drilling operations.

Brush Part	Fill Material	Diameter	Overall Length	Standard Pack	Item Number
4"	Mixed	2"	16"	24	44261
	Tampico	3"		6	44263

Key:

P Performance line
Industrial Grade

V Value line
Professional Grade

PAINT ROLLERS AND ACCESSORIES

Paint Rollers can be used almost anywhere including walls, ceilings, floors, decks, fences, metal surfaces, concrete, and brick walls. Weiler carries a wide variety of rollers for the professional painter, industrial use and those weekend DIY projects.

PAINT ROLLER SELECTION GUIDE

Work Surface	Coating	Recommended Nap
Metal, Smooth Wood, Smooth Concrete	Enamels, Epoxies, Adhesives, Paint	3/16", 3/8" (Low nap)
Rough Wood, Drywall, Cement Block	All Paint	1/2", 3/4" (Medium nap)
Stucco, Brick, Concrete	All Paint	1" (High nap)



Applying primer to new drywall.

P PROFESSIONAL GRADE ROLLERS - Poly blend with phenolic core.

Size	Nap	Painting Surface	Standard Pack	Item Number
9"	3/16"	Smooth	12	49050
	1/2"	Semi-smooth		49051
	3/4"	Rough		49052

P INDUSTRIAL GRADE ROLLERS - Poly blend with PVC core.

Size	Nap	Painting Surface	Standard Pack	Item Number
3"	3/8"	Semi-smooth	24	49046
4"	3/8"	Semi-smooth	12	49044
	3/4"	Rough		49045
9"	3/16"	Smooth	12	49061
	1/2"	Semi-smooth		49062
	3/4"	Rough		49063

V VORTEC PRO® ROLLERS - Poly blend with PVC core. Reliable and efficient rollers at a value price.

Size	Nap	Painting Surface	Standard Pack	Item Number
9"	3/8"	Semi-smooth	12	49070
	1/2"	Semi-smooth		49071

P SPECIALTY ROLLERS - Can be used with all paints. Ideal for trim and touch-up.

Description	Overall Length	Std. Pack	Item No.
3" Roller with 3/8" nap. Standard duty frame	11-1/2"	24	49016
3" Roller with 3/8" nap. Wire frame with two tin end caps. Bent wire handle.	6-1/8"	12	49015
4" Micro Perlon Roller Reach	16-3/8"	24	49025
4" Micro Perlon Twin Pack Cover	4-1/8"	24	49066

P FRAMES - All metal with two plastic caps. Solid plastic handle with threaded grip. Can be used with threaded handle #44300.

Size	Description	Overall Length	Standard Pack	Item Number
3"	Standard-duty 1/4" dia. frame with 4 wire cage	11-3/8"	24	49019
4"	Standard-duty 1/4" dia. frame with 4 wire cage	11-3/4"	24	49018
9"	Heavy-duty 5/16" dia. frame with 5 wire cage	13-1/2"	12	49022

V VORTEC PRO FRAME - Reliable and efficient frame at a value price.

Size	Description	Overall Length	Standard Pack	Item Number
9"	Standard-duty 1/4" dia. frame with 4 wire cage	12-3/4"	24	49020

P PAINT TRAYS - A variety of trays available to meet users' specific needs.

Description	Paint Capacity	Standard Pack	Item Number
4" Plastic tray	1 Quart	24	49008
9" Galvanized steel tray; Rust resistant	2 Quart	24	49010
9" Paint tray liner	2 Quart	24	96702

V VORTEC PRO PAINT TRAY - Reliable and efficient tray at a value price.

Description	Paint Capacity	Standard Pack	Item Number
9" Economy plastic tray; Rust proof	2 Quart	20	49011



49050



49045



49063



49070



49015



49025



49018



49010



49011

COATED ABRASIVES

NON-WOVEN ABRASIVES

POWER BRUSHES

NYLON BRUSHES

PACKAGED ITEMS

MAINTENANCE

ALPHABETICAL INDEX

Description	Page	Description	Page	Description	Page
4-in-1 Tube Fitting Brushes	171	Miniature	100	I	
A		Nylon Abrasive Filament (Nylox)	121	Industrial Grinding Wheels	8-9
Abrasive Flap Disc Technical Information	36-37	Stem-Mounted	85,137	Industrial Paint Brushes	175
Abrasive Flap Discs	32, 38-43,139	Cutting Wheels	14-17,139	Interleaf Flap Wheels	55
Tiger® X	38,139	Cup Wheels	22,26	Internal Tube Fitting Brushes	138,171
Tiger	38,41,139	D		J	
Big Cat®	40,139	Deck Scrub Brushes	160	Joint/Crack Cleaning Brushes	69
Tiger Trim	42,139	Deck Mops	163	K	
Tiger Angled	42	Diamond Filament Wheels	131	Knot Wire	
BobCat®	43	Disc Brushes	124-125	Wheels	67-73,136,141
Tiger Paw™	39-40,139	Display Packaged Product	140-143	Cup Brushes	83-84,137,142
Wolverine®	39-40	Dope Brushes	178	End Brushes	86,137,142
Abrasives	10-56	Drive Arbors	51,79,119,133	L	
Abrasive Nylon Filament Brushes (Nylox)	106-134	Driveway Coaters	152	Lacquering Brushes	177
Acid Brushes	166,178	Dually® Weld Cleaning Brushes	73	Lubricant (Lubricut™)	132
Adapters		Dust Mops	164	M	
Metal	51,76,82,132	Dust Pans	157	Maintenance Products	144-179
Plastic Adapters	19,69,79,119,133	Dusting Brushes	164	Maintenance Technical Information	146-147,172
Pressboard Adapters	132	E		Mandrels	19,49
Threaded	71,155	Encapsulated Brushes (Polyflex)		Marking Brushes	177
TRIM-KUT Adapters	49	Stem-Mounted Wheels (Conflex)	80	Masonry Brushes	165-166
Adapting Nuts	19,43,47,49	Conflex Brushes	80	Mech Notching Wheels	21
Angled Flap Discs	42	Crimped Wire Wheels	73,75,77,80	Metal Adapters	49,76,132
Arbor Hole Table	61	Cup Brushes	84	Metal Chip Brush	169
Artist Brushes	177	End Brushes	88	Mini Disc Brushes	121,126
Acid Scrub Brushes	166	Flared End Brushes	89	Miniature Brushes	
B		Knot Wire Wheels	73	Cup	100
Back-up Pads	43,47-48,56	Small Diameter Wire Wheels	79	End	101
Bent Radiator Brush	175	Tube Brushes	92	End (Nylox)	101,127
Bevel Brushes, Knot Wire	71	Weld Cleaning Brushes	73	Wheel	100
Big Cat® High Density Flap Discs	40,139	End Brushes		Mop Handles	163-164
Bi-Level Scrubs	160	Circular Flared	89,137	Mops	163-164
Blending Discs	48	Controlled Flare	88	Mop Bucket	163
Bob Cat™ Mini Flap Discs	43	Crimped Wire	87-89,137,142	Mounted Points	31
Bob Cat Drive Mandrel	43	Encapsulated	88-89	N	
Bonded Abrasives	10-31,139	Knot Wire	86,137,142	Nail Brushes	162
Bonded Abrasive Technical Information	11-13,25	Miniature	101	New Products	7
Bore-Rx™ Brushes	90,122	Non-Sparking	103	Non-Sparking Brushes	102-103
Bottle Washing Brush	162	Nylon Abrasive Filament (Nylox)	101,127	Non-Woven Abrasives	53-56
Bowl Brushes	161-162	Pencil	89	Non-Woven Unitized Wheels	54
Braces and Tips	155	Pilot Bonding	88	Non-Woven Flap Wheels	55
Brooms	148-153,156	Engineered Product (Nylox)	117	Non-Woven Hand Pads	55
Burr-Rx® Brushes	119-130	External Tube Fitting Brushes	171	Non-Woven Surface Conditioning Discs	56
Bus Brush	159	F		Nylon Abrasive Filament Brushes (Nylox)	106-134
C		File Card Brush	169	Adapters & Drive Arbors	132-133
Cement Finishing Brushes	166	Fitch Brushes	177	Bore-Rx	122
Chip & Oil Brushes	176	Flap Wheels	50-51,55,139	Burr-Rx	119-130
Chipping Hammer Refill	169	Flaring Cup Wheels	22,26	Cup Brushes	121
Circular Flared End Brushes	89,137	Floor Brushes	148-152	Disc Brushes	124-125
Coated Abrasives	33-52	Floor Squeegees	158	Drive Arbors	133
Coated Abrasives Technical Information	36-37	Flue Brushes	170	End Brushes	101,127
Combo Bucket	163	Flux Brushes	178	Engineered Products	117
Combo Wheels	20	FME Area Products	134	Tube Brushes	122-123
Concave Brushes	81	Foundry Abrasive Products	24-31	Wheel Brushes	119,128-131,134
Cones	22-23,28-29	G		Nylon Tube Brushes	94,162
Conflex Brushes	80-81,136,141	Garage Brushes	153	Nylon Wheels	82
Contractor Brooms	150	Glue Brushes	178	Nylox Nylon Abrasive Filament Brushes	106-134
Controlled Flare End Brushes	88	Green Works™ Maintenance Products	148	Nylox Technical Information	110-116
Counter Dusters	157	Grinding Wheels	18-21,27,139	O	
Crack Cleaning Brushes	69	Grout Detail Brush	161	Ordering Information	4
Crimped Wire Wheels	74-81,141	Gun Cleaning Brushes	94	P	
Crosshole Deburring Brushes	90,122	H		Paint Brushes	173-175
CrossFlex™ Honing Brushes	96-99	Hand Pads	55	Paint Brush Technical Information	172
Cup Brushes		Hand Scrub Brushes	160-161	Paint Rollers and Frames	179
Bonded Cups	22,26	Handles	154-155		
Crimped Wire	85,137,142	Handle Accessories	155		
Crimped Wire-Non-Sparking	103				
Knot Wire	83-84,137,142				

ITEM NUMBER INDEX

Item No.	Page	Item No.	Page	Item No.	Page	Item No.	Page	Item No.	Page	Item No.	Page
00104	74	03180	77	07756	51	09430	68	10128	103	12301	84
00105	74	03190	77	07761	54	09440	68	10134	89	12306	86
00114	74	03200	77	07764	54	09460	68	10141	86	12316	83,137
00124	74	03210	77	07766	43	09480	68	10141V	137	12316P	142
00134	74	03220	77	07769	71	09490	68	10142	86	12326	83
00135	74	03230	77	07771	71	09500	72	10150	89	12356	83,137
00144	74	03240	77	07771P	142	09510	68	10151	89	12376	83,137
00154	74	03403	132	07772	71	09530	68	10152	120,127	12376P	142
00156	80	03404	132	07772P	142	09540	68	10153	120,127	12396	83
00184	74	03405	132	08004	67	09719	67	10154	120,127	12406	83
00204	74	03480	77	08014	67	09790	68	10155	120,127	12416	83
00214	74	03510	77	08014P	141	09799	68	10156	120,127	12456	83
00234	74	03520	77	08014V	136	09800	68	10157	120,127	12476	83
00244	74	03590	77	08024	67	09809	68	10158	103	12536	84
00264	74	03680	77	08034	67	09840	68	10172	120,127	12556	84
00274	74	03809	76,82,132	08044	67	09856	72	10173	120,127	12576	84
01035	74	03810	76,82,132	08044P	141	09866	72	10174	120,127	12636	84
01045	74	03811	76,82,132	08045	67	09870	67	10187	86	12676	84
01049	74	03812	76,82,132	08064	67	09980	68	10188	87	12686	84
01055	74	03813	76,82,132	08075	67	09990	68	10208	86	12726	84
01065	74	03814	76,82,132	08085	67	10001	87	10210	86	12736	83
01068	74	03824	76,82,132	08085P	141	10001V	137	10211	86	12746	83
01075	74	03833	51	08095	67	10002	87	10212	86	12756	84
01075P	141	03834	51	08105	67	10003	87	10213	86	12766	84
01085	75	03835	51	08106	70	10004	87	10215	86	12776	102
01095	75	03890	132	08125	67	10005	87	10216	86	12796	84
01115	75	03892	132	08135	67	10005V	137	10217	86	12826	83
01125	75	03893	132	08138	67	10006	87	10218	86	12816	83
01135	74	03895	132	08145	67	10007	87	10220	86	12846	83
01138	74	03910	132	08155	67	10008	87	10301	88	12856	83
01145	74	03911	132	08178	67	10008P	142	10302	88	12866	83
01148	74	03912	132	08179	67	10008V	137	10303	88	12886	83
01155	74	03913	132	08189	67	10009	87	10305	88	12906	84
01158	74	03915	132	08200-14	67	10009V	137	10306	88	12916	84
01165	74	03920	132	08209	67	10010	87	10307	88	12926	84
01168	74	03921	132	08219	67	10010V	137	10309	88	13001	143
01175	74	03922	132	08254	67	10011	87	10310	88	13002	143
01175P	141	03923	132	08264	67	10012	87	10311	88	13300	84
01178	74	03925	132	08264V	136	10012P	142	10313	88	13301	84
01179	74	03931	132	08271	102	10013	87	10314	88	13302	84
01228	74	03933	132	08274	67	10013V	137	10315	88	13009	83
01238	74	03934	132	08284	67	10014	87	10317	88	13015	83
01248	74	03936	132	08294	67	10015	87	10319	88	13016	83
01250-12	74	03944	132	08300	68	10016	87	10321	88	13020	83
01258	74	03945	132	08309	68	10017	87	10322	88	13021	83
01259	74	03946	132	08310	68	10017V	137	10323	88	13025	83,137
01299	74	03954	132	08314	67	10018	87	10370	87	13025P	142
01309	74	03955	132	08319	68	10019	87	10371	87	13077	80
01319	74	03956	132	08325	67	10020	87	10372	87	13078	80
01320-14	74	03960	132	08330	68	10021	87	10373	87	13081	80
01329	74	03963	132	08339	68	10021V	137	10374	87	13085	80
01339	74	03965	132	08345	67	10022	87	10375	87	13100	70
01349	74	03973	132	08346	70	10022V	137	10376	87	13101	70
01415	102	03974	132	08375	67	10023	87	10377	87	13102	70
01475	102	03975	132	08395	67	10024	87	10378	87	13103	70
01501	75	03991	90,122	08534	69	10025	86	10379	87	13105	70
01502	75	03993	90,122	08534V	136	10025P	142	10380	87	13106	70
01503	75	04400	79,119,133	08565	69	10026	86	10381	87	13106P	141
01504	75	04401	79,119,133	08615	69	10026P	142	10387	86	13106V	136
01505	75	04402	79,119,133	08695	69	10026V	137	10388	86	13107	70
01506	75	04455	19,69	08750	72	10027	86	10392	86	13108	70
01508	75	06020	76	08756	72	10027P	142	10393	86	13109	70
01509	75	06040	76	08756V	136	10027V	137	11000	87	13110	70
01511	75	06050	76	08766	72	10028	86	11001	87	13113	70
01512	75	06060	76	08766V	136	10028P	142	11003	87	13113P	141
01513	75	06070	76	08775	72	10028V	137	11004	87	13113V	136
01514	75	06080	76	08776	72	10029	86	11006	87	13114	70
01515	75	06090	76	08776P	141	10029V	137	11007	87	13115	70
01517	75	06100	76	08776V	136	10030	86	11010	87	13116	70
01518	75	06110	76	08786	72	10031	86	11011	87	13117	70
01675	74	06120	76	08796	72	10031V	137	11013	87	13119	70
01695	74	06150	76	08806	72	10032	86	11014	87	13120	70
01705	74	06160	76	08806V	136	10033	89	11016	87	13120V	136
01775	74	06170	76	08835	67	10034	89	11017	87	13121	102
01795	74	06180	76	08878	69	10035	89	1100	88	13124	72
01805	74	06190	76	08879	69	10037	89	11101	88	13125	72
01809	74	06200	76	08916	72	10038	89	11102	88	13125P	141
01898	74	06440	76	08926	72	10039	89	11103	88	13126	72
01939	74	06450	76	08954	72	10040	89	11105	88	13127	72
01949	74	06490	76	08975	67	10041	89	11110	88	13128	72
02325	76	06530	76	09000	72	10041V	137	11112	88	13130	72
02325P	141	06620	76	09000P	141	10042	89	11113	88	13131	72
02335	76	06645	77	09000V	136	10043	89	11114	88	13131P	141
02335P	141	06645P	141	09020	68	10044	89	11115	88	13131V	136
03000	77	06655	77	09049	68	10045	89	11140	86	13132	72
03010	77	07700	133	09080	68	10046	89	11141	86	13134	72
03020	77	07701	133	09100	72	10047	89	11142	89	13135	72
03030	77	07702	133	09104	68	10048	89	11160	120,127	13137	72
03040	77	07703	133	09134	68	10050	89	11161	120,127	13138	72
03050	77	07715	133	09160	68	10056	88	11162	120,127	13138P	141
03060	77	07721	79,119	09180	68	10057	88	11165	120,127	13138V	136
03070	77	07722	79	09200	72	10058	88	11166	120,127	13150	83
03090	77	07723	79,119	09379	69	10059	88	11169	120,127	13151	83
03100	77	07724	79,119	09386	72	10067	103	11170	120,127	13152	83
03110	77	07725	79,119	09396	72	10073	89	12120	84	13153	83
03130	77	07726	79	09400	72	10074	89	12206	83	13155	83
03140	77	07727	79	09400P	141	10076	89	12256	83	13156	83,137
03150	77	07729	79,119	09400V	136	10091	103	12276	83,137	13156P	142
03160	77	07746	71	09410	68	10099	89	12276P	142	13159	83

ITEM NUMBER INDEX

Item No.	Page	Item No.	Page	Item No.	Page	Item No.	Page	Item No.	Page	Item No.	Page
13160	83	14403	121	17610	80	21008	93	21144	92	25241	153
13163	83,137	14404	121	17610V	136	21009	93	21146	92	25242	153
13175	85	14413	121	17611	80	21014	93	21148	92	25251	157
13176	85	14414	121	17611V	136	21015	93	21149	92	25252	157
13177	85	14506	121	17612	80	21020	93	21150	92	25262	161
13178	85	14516	121	17614	80	21021	93	21152	103	25263	161
13181	85,137	14576	121	17615	80	21023	93	21161	93	25271	158
13182	85	14606	103	17615P	141	21025	93	21162	93	25290	152
13184	85	14616	103	17615V	136	21027	93	21164	91	25291	152
13185	85	15071	78	17616	80	21028	93	21165	103	25294	152
13187	85	15101	78	17616V	136	21030	93	21167	91	25295	152
13188	85	15111	78	17617	80	21031	93	21175	92	25297	154
13201	70	15131	78	17617P	141	21034	93	21178	103	25299	152
13208	70	15141	78	17618	80	21035	93	21179	103	26000	100
13231	103	15151	78	17618V	136	21036	93	21181	92	26001	100
13232	72	15302	78	17619	81	21040	93	21184	91	26003	100
13232V	136	15312	78	17620	81	21041	93	21182	103	26004	100
13234	72	15322	78	17621	81	21044	93	21191	103	26005	100
13238	72	15332	78	17622	81	21050	93	21203	92	26012	100
13240	85	15433	78	17623	81	21051	93	21218	103	26014	100
13240P	142	15443	78	17628	119	21053	93	21219	103	26015	100
13241	85	15453	78	17629	119	21055	93	21221	103	26016	100
13242	85	15463	78	17633	119	21056	93	21232	91	26017	100
13243	85	15473	78	17637	81	21057	93	21233	93	26021	100
13244	85	15513	78	17641	102	21058	93	21236	91	26041	100
13245	85,137	15523	78	17641V	136	21072	92	21240	92	26042	100
13245P	142	15533	78	17680	71	21073	92	21245	91	26043	100
13249	72	15543	78	17681	71	21073V	138	21246	93	26059	100
13253	83	15553	78	17681V	136	21074	92	21247	91	26071	100
13254	83	15563	78	17682	71	21074V	138	21249	93	26072	100
13255	83	15573	78	17684	71	21075	92	21252	91	26074	100
13256	83	15637	78	17686	71	21075V	138	21264	92	26075	100
13257	83	15647	78	17687	71	21076	92	21265	92	26076	100
13258	83,137	15667	78	17687V	136	21077	92	21266	92	26091	100
13261	70	15677	78	17689	71	21077V	138	21267	92	26093	100
13266	70	15732	78	17691	71	21078	92	21269	92	26094	100
13266P	141	15753	78	17901	81	21078V	138	21270	103	26095	100
13266V	136	15762	78	17902	81	21079	92	21282	92	26096	100
13272	70	15863	78	17903	81	21080	92	21304	123	26098	101
13276	70	16263	119	17906	81	21081	92	21305	123	26097	101
13281	83	16310	119	17907	81	21081V	138	21306	123	26099	101
13281P	142	16315	119	17909	81	21082	92	21308	123	26101	101
13282	83	16461	78	17912	81	21083	92	21309	123	26106	101
13283	83	16471	78	17914	81	21084	92	21311	123	26107	101
13284	83	16511	78	17915	81	21085	92	21312	123	26108	101
13285	83	16521	78	17917	81	21086	92	21322	92	26113	101
13286	83,137	16712	78	17922	81	21087	92	21325	123	26114	101
13286P	142	16833	78	17923	81	21088	92	21326	123	26115	101
13299	102	16843	78	17930	81	21089	92	21327	123	26116	101
13401	71	16853	78	17931	81	21090	93	21328	123	26119	101
13402	71	16873	78	17933	81	21091	93	21329	123	26122	101
13406	71	16933	78	17935	81	21092	93	21330	123	26121	101
13416	71	16943	78	17936	81	21093	93	21332	103	26128	101
13423	71	16963	78	17937	81	21094	93	21340	92	26131	101
13426	71	16973	78	17950	81	21095	93	21342	91	26133	101
13436	71	17202	90	17951	81	21096	93	21345	123	26136	101,120,127
13456	71	17203	90	17952	81	21097	93	21404	92	26138	101,120,127
13466	71	17205	90	17953	81	21098	93	21413	91	26140	100
13476	71	17206	122	17954	81	21099	93	21414	93	26141	100
13486	71	17207	90	17955	81	21100	93	21473	123	26143	100
13709	83	17208	122	17956	81	21101	93	21757	123	26144	100
13710	83	17209	90	17957	81	21103	93	21758	123	26146	101,120,127
13711	83	17210	122	17958	81	21104	93	21759	123	26155	100
13712	83	17211	90	17959	81	21105	93	21760	123	26296	100
13715	83	17212	122	17961	81	21106	91	21761	123	26294	100
13716	83	17214	90	17962	81	21107	91	21762	123	26900	122
13717	83	17215	122	17963	81	21107V	138	21763	123	26901	122
13718	83	17216	90	17964	81	21108	91	21764	123	26902	122
14016	85	17217	122	17965	81	21108V	138	21765	123	26903	122
14026	85,137	17218	90	17966	81	21109	91	21976	123	26904	122
14036	85	17219	90	17967	81	21110	91	22021	76	26905	122
14036P	142	17223	82	17968	81	21110V	138	22061	76	26906	122
14066	85,137	17233	82	17969	81	21111	91	22241	76	26907	122
14076	85	17263	82	17971	81	21112	91	22602	123	26908	122
14076P	142	17443	82	17972	81	21113	91	22603	123	26909	122
14126	85	17453	82	17973	81	21114	91	22604	123	26910	122
14166	85	17532	119	17974	81	21114V	138	22605	123	26911	122
14206	85,137	17533	119	17975	81	21115	91	22606	123	26912	122
14216	85	17535	119	17976	81	21116	91	22607	123	26913	122
14256	85	17541	119	17977	81	21117	91	22608	123	26914	122
14300	85	17542	119	17978	81	21118	91	22610	123	26915	122
14301	85	17543	119	17979	81	21119	91	22614	123	29059	102
14301V	137	17548	119	17981	81	21120	91	22616	123	29070	82
14302	85,137	17551	119	17982	81	21121	91	25100	167	29078	102
14303	85	17555	119	20180	82	21122	91	25104	167	29086	102
14304	85	17556	119	20190	82	21123	91	25150	167	29088	119
14306	85	17557	119	20490	82	21124	91	25154	167	29123	119
14310	103	17563	119	20510	82	21125	91	25201	167	29178	102
14311	103	17565	119	20600	129	21126	123	25202	167	29280	119
14313	85	17567	119	20610	129	21128	123	25211	168	29353	119
14314	103	17568	119	20620	129	21130	123	25212	169	29356	119
14315	85	17600	81	20630	129	21132	123	25221	174	30711	51
14316	103	17601	81	20650	129	21133	123	25222	174	30712	51
14317	85	17602	81	20661	129	21134	123	25231	151	30713	51
14318	85	17603	81	20730	129	21136	123	25232	151	30715	51
14319	85	17604	81	21000	93	21138	123	25234	151	30716	51
14320	85	17605	81	21001	93	21139	103	25235	151	30717	51
14321	85	17608	81	21004	93	21142	92	25238	153	30719	51
14401	121	17609	80	21005	93	21143	92	25239	153	30720	51

ITEM NUMBER INDEX

Item No.	Page	Item No.	Page	Item No.	Page	Item No.	Page	Item No.	Page	Item No.	Page
30720V	139	31420	39	34193	98	34293	99	35535	88	40059	173
30721	51	31421	39	34194	98	34294	99	35540	88	40060	173
30721V	139	31422	39	34195	98	34295	99	35545	88	40061	173
30722	51	31439	40	34196	98	34296	99	35600	73	40062	173
30723	51	31440	40	34197	98	34297	99	35760	84	40065	176
30723V	139	31441	40	34198	98	34298	97	35800	73	40066	176
30724	51	31443	40	34199	98	34299	97	35808	79	40067	176
30724V	139	31444	40	34200	98	34300	97	35821	92	40068	176
30725	51	31445	40	34201	98	34301	97	35822	92	40069	176
30726	51	31447	39	34202	98	34302	97	35823	92	40070	176
30726V	139	31448	39	34203	98	34303	97	35825	92	40071	176
30727	51	31449	39	34204	98	34304	97	36200	75	40074	175
30727V	139	31451	39	34205	98	34305	97	36201	75	40076	176
30728	51	31452	39	34206	98	34306	97	36203	76	40077	178
30732	51	31453	39	34207	98	34307	97	36204	77	40078	178
30771	51	34105	97	34208	98	34308	97	36205	75	40080	178
30772	51	34106	97	34209	98	34309	97	36207	80	40082	178
30778	51	34107	97	34210	98	34310	97	36208	81	40089	175, 178
30729	51	34108	97	34211	98	34311	97	36209	81	40101	175
30735	51	34109	97	34212	98	34312	97	36211	81	40103	175
30736	51	34110	97	34213	98	34313	97	36212	70	40104	175
30737	51	34111	97	34214	98	34314	97	36213	70	40106	173
30738	51	34112	97	34215	98	34315	97	36215	70	40107	175
30745	51	34113	97	34216	98	34316	97	36216	70	40108	175
30746	51	34114	97	34217	98	34317	97	36217	70	40109	175
31074	130	34115	97	34218	98	34318	97	36218	73	40110	175
31084	130	34116	97	34219	98	34319	97	36219	73	40111	175
31094	130	34117	97	34220	98	34320	97	36224	70	40113	173
31100	130	34118	97	34221	98	34321	97	36225	73	40114	173
31101	130	34119	97	34222	98	34322	97	36226	67	40115	173
31102	130	34120	97	34223	98	34323	97	36227	67	40116	174
31103	130	34121	97	34224	98	34324	97	36228	67	40118	174
31104	130	34122	97	34225	98	34325	97	36230	85	40119	174
31105	130	34123	97	34226	98	34326	97	36231	85	40120	174
31110	130	34124	97	34227	98	34327	97	36232	85	40121	174
31111	134	34125	97	34228	98	34328	97	36236	85	40122	174
31112	134	34126	97	34229	98	34329	97	36237	85	40137	176
31114	130	34127	97	34230	98	34330	97	36238	84	40139	176
31121	130	34128	97	34231	98	34331	97	36239	84	40140	176
31122	130	34129	97	34232	98	34332	97	36244	84	40141	176
31123	130	34130	97	34233	98	34333	97	36245	84	40177	176
31124	130	34131	97	34234	98	34334	97	36246	87	40179	176
31134	130	34133	97	34235	98	34335	97	36247	87	40180	176
31135	130	34134	97	34236	98	34336	97	36248	87	40181	176
31136	130	34135	97	34237	98	34337	97	36249	87	40182	176
31137	130	34136	97	34238	98	34338	97	36250	86	40183	176
31240	130	34137	97	34239	98	34339	97	36251	86	40184	176
31241	130	34138	97	34240	98	34340	97	36255	70	40185	176
31245	130	34139	97	34241	98	34341	97	36257	70	40160	176
31255	130	34141	97	34242	98	34342	97	36258	70	40161	176
31265	130	34142	97	34243	98	34343	97	36259	81	40162	176
31270	130	34143	97	34244	98	34344	97	36262	75	40163	176
31275	130	34144	97	34245	98	34345	97	36265	77	40164	176
31280	130	34145	97	34246	98	34346	97	36279	67	40165	176
31285	130	34146	97	34247	98	34347	97	36282	87	40166	176
31290	130	34147	97	34248	98	34348	97	36283	87	41000	177
31337	39	34148	97	34249	98	34349	97	36284	87	41001	177
31338	39	34149	97	34250	98	34350	97	36285	87	41002	177
31339	39	34150	97	34251	98	34351	97	36286	86	41003	177
31340	39	34151	97	34252	98	34352	97	36287	86	41004	177
31343	39	34152	97	34253	98	34353	97	36288	86	41005	177
31344	39	34153	97	34254	98	34354	97	36289	86	41007	177
31345	39	34154	97	34255	98	34355	97	36290	67	41008	177
31346	39	34155	97	34256	98	34356	97	36293	67	41009	177
31347	39	34156	97	34257	98	34357	97	36295	73	41010	177
31349	39	34158	97	34258	98	34358	97	36296	73	41011	177
31350	39	34159	97	34259	98	34359	97	36297	73	41012	177
31351	39	34160	97	34260	98	35006	84	36303	171	41013	177
31352	39	34161	97	34261	98	35070	79	36304	171	41018	177
31353	39	34162	97	34262	98	35084	75	36305	171	41019	177
31355	39	34163	97	34263	98	35105	75	36307	73	41020	177
31356	39	34164	97	34264	98	35117	75	36666	163	41021	177
31357	39	34165	97	34265	98	35135	75	40000	173	41022	177
31358	39	34166	97	34266	98	35160	77	40001	173	41023	177
31361	39	34167	97	34267	98	35186	84	40002	173	41024	177
31362	39	34168	97	34268	98	35206	73	40004	173	41025	177
31363	39	34169	97	34269	98	35216	73	40008	173	42001	151
31364	39	34170	97	34270	99	35222	89	40010	173	42002	151
31367	39	34171	97	34271	99	35223	89	40011	173	42006	151
31368	39	34172	97	34272	99	35224	89	40014	173	42007	151
31369	39	34173	97	34273	99	35226	89	40017	173	42008	151
31370	39	34174	97	34274	99	35233	89	40018	173	42013	151
31387	40	34175	97	34275	99	35234	89	40019	174	42014	151
31388	40	34176	97	34276	99	35240	79	40020	174	42016	151
31389	40	34177	97	34277	99	35250	79	40021	174	42017	151
31390	40	34178	97	34278	99	35260	79	40022	173	42021	153
31391	40	34179	97	34279	99	35293	79	40023	173	42022	153
31392	40	34180	97	34280	99	35294	79	40026	176	42023	153
31401	39	34181	97	34281	99	35305	80	40027	176	42025	153
31402	39	34182	97	34282	99	35310	80	40028	176	42026	153
31403	39	34183	97	34283	99	35315	80	40029	176	42030	153
31404	39	34184	97	34284	99	35340	88	40030	176	42032	153
31405	39	34185	97	34285	99	35345	88	40031	176	42033	153
31407	39	34186	97	34286	99	35350	88	40032	176	42035	151
31408	39	34187	97	34287	99	35406	84	40035	174	42037	151
31409	39	34188	97	34288	99	35416	80	40036	174	42041	151
31410	39	34189	97	34289	99	35500	88	40040	173	42042	151
31414	39	34190	98	34290	99	35505	88	40041	173	42047	151
31415	39	34191	98	34291	99	35520	75	40056	174	42049	151
31419	39	34192	98	34292	99	35530	84	40058	173	42054	153

ITEM NUMBER INDEX

Item No.	Page	Item No.	Page	Item No.	Page	Item No.	Page	Item No.	Page	Item No.	Page
42055	153	44090V	138	44606	149	50015	42	50803V	139	51140	39
42095	151	44097	178	44609	168	50016	42	50804	40	51142	39
42098	151	44099	156	44619	168	50100	38	50804V	139	51143	39
42099	153	44100	167	44624	155	50101	38	50805	40	51145	39
42114	151	44101	167	44635	154	50102	38	50806	40	51146	39
42134	152	44103	156	44637	168	50103	38	50808	40	51147	39
42135	152	44110	94,162	44637V	138	50104	38	50808V	139	51148	39
42138	153	44111	94,162	44660	168	50105	38	50809	40	51149	39
42149	153	44112	94,162	44663	161	50105V	139	50809V	139	51150	39
42163	150	44113	94,162	44690	171	50106	38	50810	40	51153	39
42164	150	44114	94,162	44692	160	50106V	139	50823	40	51154	39
42165	150	44115	94,162	44693	160	50107	38	50824	40	51155	39
42166	150	44116	168	44699	160	50108	38	50825	40	51156	39
42167	150	44117	168	44731	168	50109	38	50843	40	51157	39
42168	150	44416	161	44732	168	50110	38	50844	40	51158	39
42173	153	44118	168	44733	168	50111	38	50845	40	51160	40
42174	153	44119	168	44734	171	50112	38	50846	40	51161	40
42210	159	44418	161	44735	171	50113	38	50902	43	51162	40
42213	157	44124	170	44736	171	50114	38	50903	43	51163	40
42352	148	44125	170	44737	171	50115	38	50904	43	51164	40
42353	148	44128	170	44738	171	50117	42	50905	43	51165	40
42354	148	44131	170	44739	171	50118	42	50906	43	51166	40
42355	148	44133	170	44805	169	50119	42	50912	43	51167	40
42356	148	44135	170	44806	169	50121	42	50913	43	51168	40
42357	148	44137	170	44810	169	50122	42	50914	43	51169	40
42360	148	44139	170	44819	151	50123	42	50915	43	51170	40
42365	148	44144	134	44851	151	50130	40	50916	43	51171	40
42368	148	44149	170	44852	151	50131	40	50922	43	51175	39
42371	148	44150	170	44853	151	50132	40	50923	43	51176	39
42372	148	44152	170	44855	151	50133	40	50924	43	51177	39
42373	148	44154	170	44856	151	50134	40	50925	43	51179	39
42375	148	44156	170	44857	151	50135	40	50926	43	51180	39
42376	148	44159	170	44858	151	50136	40	50932	43	51182	39
42383	154	44167	168	44859	151	50137	40	50933	43	51181	39
44001	162	44167V	138	44860	151	50138	40	50934	43	51183	39
44003	157	44169	170	44861	151	50139	40	50935	43	51184	40
44004	157	44189	168	44862	151	50140	40	50936	43	51185	40
44007	156	44189V	138	44863	153	50141	40	50946	43	51187	40
44008	156	44213	94,162	44864	153	50502	41	50947	43	51188	40
44009	156	44232	168	44865	153	50503	41	50948	43	51189	40
44011	165	44235	167	44866	153	50504	41	50949	43	51195	40
44013	161	44240	168	44867	153	50505	41	50950	43	51196	40
44014	161	44251	168	44868	153	50506	41	50951	43	51197	40
44016	161	44260	169	44871	152	50509	41	50952	43	51199	40
44017	161	44261	178	44872	152	50510	41	50953	43	51200	38
44018	154	44263	178	44873	153	50511	41	50955	43	51201	38
44019	154	44266	156	44874	153	50512	41	50954	43	51201V	139
44020	154	44290	155	44875	159	50513	41	50956	43	51202	38
44021	155	44299	167	44879	166	50513V	139	50957	43	51202V	139
44023	160	44300	154	44880	166	50514	41	50958	43	51203	38
44024	160	44301	154	44881	166	50514V	139	50959	43	51204	38
44025	160	44302	154	44882	166	50515	41	50960	43	51205	38
44026	160	44303	154	44883	165	50516	41	50961	43	51205V	139
44027	160	44305	156	44884	165	50517	41	50962	43	51206	38
44028	160	44306	154	44885	152	50518	41	50963	43	51206V	139
44029	160	44307	159	49008	179	50518V	139	50964	43	51207	38
44031	165	44314	162	49010	179	50519	41	50965	43	51208	38
44032	165	44315	159	49011	179	50519V	139	51060	40	51209	38
44034	165	44316	94,162	49015	179	50520	41	51061	40	51210	38
44035	170	44317	155	49016	179	50522	41	51062	40	51211	38
44036	170	44318	159	49018	179	50523	41	51063	40	51212	38
44037	170	44319	155	49019	179	50524	41	51064	40	51213	38
44038	170	44351	157	49020	179	50525	41	51065	40	51214	38
44047	170	44354	157	49022	179	50526	41	51066	40	51215	38
44048	170	44391	160	49025	179	50532	41	51067	40	51216	38
44053	138,167	44395	160	49044	179	50533	41	51101	39	51217	38
44054	138,167	44428	160	49045	179	50534	41	51102	39	51218	38
44055	167	44429	160	49046	179	50538	38	51104	39	51219	38
44056	167	44432	167	49050	179	50539	38	51105	39	51220	38
44057	167	44434	160	49051	179	50540	38	51107	39	51221	38
44058	167	44435	154	49052	179	50541	41	51108	39	51222	38
44061	167	44438	160	49061	179	50542	41	51109	39	51223	38
44062	167	44448	165	49062	179	50543	41	51110	39	51224	38
44063	138,167	44451	169	49063	179	50544	41	51112	39	51225	38
44064	138,167	44499	155	49066	179	50545	41	51113	39	51226	38
44065	167	44510	159	49070	179	50546	41	51114	39	51227	38
44066	169	44546	156	49071	179	50592	38	51115	39	51228	38
44067	169	44547	156	45500	158	50593	38	51118	39	51229	38
44069	168	44548	156	45506	158	50594	38	51119	39	51230	38
44070	169	44551	168	45507	158	50595	38	51119V	139	51231	38
44074	169	44553	150	45510	158	50601	38	51120	39	51232	38
44075	168	44561	155	45511	158	50606	38	51120V	139	51233	38
44075V	138	44562	155	45534	158	50616	38	51121	39	51234	38
44076	168	44563	155	45535	158	50649	38	51123	39	51237	38
44077	168	44571	154	45537	158	50650	38	51124	39	51238	38
44078	171	44572	154	45538	158	50651	38	51124V	139	51239	38
44079	171	44573	154	50002	42	50659	38	51125	39	51241	38
44080	171	44574	154	50003	42	50660	38	51125V	139	51242	38
44080V	138	44577	154	50004	42	50661	38	51126	39	51243	38
44081	171	44578	154	50005	42	50693	38	51128	39	51250	41
44082	171	44581	150	50006	42	50694	38	51129	39	51251	41
44083	171	44582	150	50006V	139	50695	38	51130	39	51252	41
44084	171	44584	150	50007	42	50696	38	51131	39	51253	41
44085	171	44587	150	50007V	139	50699	38	51132	39	51254	41
44086	171	44590	150	50008	42	50706	38	51133	39	51255	41
44087	171	44591	150	50009	42	50713	38	51134	39	51256	41
44088	178	44594	167	50010	42	50714	38	51135	39	51257	41
44088V	138	44600	149	50011	42	50715	38	51137	39	51300	42
44089V	138	44601	149	50012	42	50746	38	51138	39	51301	42
44090	178	44604	149	50014	42	50803	40	51139	39	51302	42

ITEM NUMBER INDEX

Item No.	Page	Item No.	Page	Item No.	Page	Item No.	Page	Item No.	Page	Item No.	Page
51303	42	56061	16	57061	15	58081	19	58345	16	59905	46
51304	42	56062	16	57063	16	58080	19	58348	16	59906	46
51305	42	56064	16	57064	16	58082	19	58351	16	59907	46
51306	42	56065	16	57065	16	58083	19	59300	49	59911	46
51307	42	56068	16	57066	16	58090	21	59305	49	59912	46
51308	42	56070	16	57068	16	58092	21	59315	49	59913	46
51309	42	56076	16	57069	16	58094	21	59326	49	59914	46
51310	42	56080	16	57070	16	58095	21	59327	49	59915	46
51311	42	56086	16	57071	16	58100	15	59403	49	59916	46
51312	42	56099	16	57072	16	58101	15	59491	47	59917	46
51313	42	56103	15	57073	16	58102	15	59492	47	59971	47
51314	42	56108	15	57074	16	58103	15	59493	47	59973	47
51315	42	56118	15	57075	16	58107	15	59494	47	59975	47
51316	42	56128	16	57076	16	58109	15	59495	47	59976	47
51317	42	56129	16	57077	16	58110	15	59496	47	59977	47
51318	42	56130	16	57078	16	58111	15	59497	47	59978	47
51319	42	56131	16	57080	15	58112	15	59500	47	59979	47
51320	42	56163	16	57081	15	58113	15	59501	47	60040	48
51321	42	56165	16	57082	15	58114	20	59503	47	60043	48
51322	42	56166	16	57083	15	58115	20	59505	47	60044	48
51323	42	56167	16	57084	17	58116	20	59506	47	60046	48
51434	55	56230	17	57085	17	58117	20	59507	47	60053	48
51444	55	56239	17	57086	17	58118	20	59508	47	60056	48
51454	55	56240	17	57087	17	58119	20	59509	47	60057	48
51456	55	56247	17	57089	17	58120	18	59520	47	60059	48
51457	55	56270	16	57091	17	58121	18	59521	47	60118	48
51458	55	56271	15	57090	17	58122	18	59523	47	60121	48
51460	55	56273	15	57092	17	58123	18	59525	47	60122	48
51506	56	56275	15	57093	17	58124	18	59526	47	60124	48
51507	56	56277	15	57094	17	58125	18	59527	47	60131	48
51508	56	56278	15	57097	17	58126	18	59528	47	60134	48
51512	56	56279	19	57100	20	58127	18	59529	47	60135	48
51513	56	56280	19	57101	20	58128	18	59541	47	60137	48
51514	56	56281	15	57102	20	58129	18	59543	47	60150	48
51515	56	56282	15	57103	20	58130	14	59545	47	60151	48
51516	56	56283	15	57104	20	58131	14	59546	47	60152	48
51517	56	56383	15	57105	20	58200	15	59547	47	60155	48
51521	56	56384	15	57106	20	58201	15	59548	47	60156	48
51522	56	56385	15	57107	20	58202	15	59549	47	60157	48
51523	56	56391	15	57108	20	58203	15	59571	47	60170	48
51530	56	56392	15	57109	20	58205	15	59573	47	60171	48
51531	56	56393	15	57119	18	58206	15	59575	47	60172	48
51532	56	56423	20	57120	18	58207	15	59576	47	60175	48
51533	56	56424	20	57121	18	58208	15	59577	47	60176	48
51534	56	56425	20	57122	18	58209	15	59578	47	60177	48
51535	56	56426	20	57123	18	58210	15	59579	47	60378	48
51551	48,56	56427	20	57124	18	58211	15	59600	47	60381	48
51552	43,48,56	56428	20	57125	18	58212	15	59601	47	60382	48
51562	56	56429	20	57126	18	58215	20	59602	47	60384	48
51569	56	56430	20	57127	18	58216	20	59603	47	60391	48
51575	56	56449	19	57128	18	58217	20	59604	47	60394	48
51578	56	56454	19	57129	18	58218	20	59605	47	60395	48
52003	50	56455	19	57134	19	58219	20	59611	47	60397	48
52004	50	56457	19	57135	19	58220	20	59701	46	60400	45
52005	50	56464	19	57136	19	58221	20	59702	46	60401	45
52009	50	56466	19	57137	19	58222	20	59703	46	60402	45
52010	50	56467	19	58000	15	58225	18	59704	46	60403	45
52011	50	56468	19	58001	15	58226	18	59705	46	60404	45
52015	50	56469	19	58002	15	58227	18	59706	46	60406	45
52016	50	56470	19	58003	15	58228	18	59707	46	60410	45
52017	50	56473	19	58005	14	58229	18	59711	46	60411	45
52024	50	56474	15	58006	14	58230	18	59712	46	60412	45
52025	50	56475	15	58011	16	58231	18	59713	46	60413	45
52027	50	56476	15	58012	16	58232	18	59714	46	60414	45
52028	50	56477	15	58013	16	58233	18	59715	46	60416	45
52029	50	56484	19,43	58014	16	58234	18	59716	46	60420	45
52366	50	56485	49	58020	15	58300	15	59717	46	60421	45
52367	50	56489	19,54	58021	15	58301	15	59731	46	60422	45
52486	50	56490	19	58022	15	58302	15	59732	46	60423	45
52487	50	56491	19	58023	15	58303	15	59733	46	60424	45
52601	50	56494	19,43	58028	17	58305	15	59734	46	60426	45
52603	50	56495	19,43	58029	17	58306	15	59735	46	60508	48
52605	50	56496	19	58030	15	58307	15	59736	46	60509	43,48
52611	50	57001	46	58031	15	58308	15	59737	46	60600	45
52613	50	57010	16	58032	15	58309	15	59806	48	60601	45
52621	50	57011	16	58033	15	58310	15	59807	48	60602	45
52623	50	57012	16	58051	20	58311	15	59808	48	60603	45
53286	50	57014	16	58050	20	58312	15	59809	48	60604	45
53287	50	57015	16	58052	20	58315	20	59811	48	60606	45
53326	50	57016	16	58053	20	58316	20	59812	48	60610	45
53327	50	57020	15	58054	20	58317	20	59813	48	60611	45
54492	54	57021	15	58055	20	58318	20	59814	48	60612	45
54500	55	57022	15	58056	20	58319	20	59869	48	60613	45
54501	55	57023	15	58057	20	58320	20	59870	48	60614	45
54502	55	57030	17	58058	20	58321	20	59871	48	60616	45
54506	55	57031	17	58064	20	58322	20	59874	48	60620	45
54507	55	57032	17	58066	21	58323	20	59875	48	60621	45
54508	55	57034	17	58067	21	58324	20	59876	48	60622	45
54509	55	57035	17	58068	21	58325	18	59877	48	60623	45
54510	55	57040	15	58069	18	58326	18	59931	46	60624	45
54511	55	57041	15	58070	18	58327	18	59932	46	60626	45
55512	54	57042	15	58071	18	58328	18	59933	46	61012	143
55513	54	57043	15	58072	18	58329	18	59934	46	61501	47
55541	54	57044	15	58073	18	58330	18	59935	46	61503	47
55542	54	57045	15	58074	18	58331	18	59936	46	61505	47
55546	54	57046	15	58075	18	58332	18	59937	46	61506	47
56013	16	57047	15	58076	18	58333	18	59901	46	61507	47
56015	16	57048	15	58077	18	58334	18	59902	46	61508	47
56022	16	57049	15	58078	18	58335	18	59903	46	61509	47
56060	16	57060	16	58079	18	58342	16	59904	46	61521	47

ITEM NUMBER INDEX

Item No.	Page	Item No.	Page	Item No.	Page	Item No.	Page	Item No.	Page	Item No.	Page
61523	47	68306	23,28	69861	45	75173	163	85733	121,126	86151	122
61525	47	68307	23,28	69864	45	75180	163	85736	121,126	86152	122
61526	47	68308	23,28	69865	45	75181	163	85738	121,126	86154	122
61527	47	68309	23,28	69866	45	75182	163	85750	121,126	86155	122
61528	47	68310	23,28	69867	45	75202	158	85751	121,126	86156	122
61529	47	68311	23,28	69868	45	75505	155	85752	121,126	86159	134
61541	47	68312	23,28	69871	45	75516	154	85753	121,126	86160	134
61543	47	68313	23,28	69872	45	75525	154	85773	121,126	86165	130
61545	47	68314	23,28	69873	45	75527	154	85776	121,126	86167	124
61546	47	68315	23,29	69874	45	75528	154	85778	121,126	86171	134
61547	47	68316	23,29	69875	45	75555	154	85786	121,126	86172	134
61548	47	68317	23,29	69880	45	75570	162	85788	121,126	86181	128
61549	47	68318	23,29	69881	45	77013	151	85792	121,126	86182	128
62002	46	68319	23,29	69882	45	77014	151	85794	121,126	86198	124
62003	46	68320	23,29	69883	45	79100	161	85798	121,126	86199	124
62004	46	68321	23,29	69884	45	79101	161	85800	121,126	86204	124
62005	46	68322	23,29	69887	45	79107	161	85806	121,126	89023	133
62006	46	68323	23,29	69888	45	79109	161	85812	121,126	89024	133
62007	46	68324	23,29	69889	45	79120	161	85814	121,126	89029	133
62008	46	68325	23,29	69890	45	79251	166	85816	121,126	89033	133
62012	46	68326	23,29	69891	45	79252	166	85818	121,126	94000	68
62013	46	68327	23,29	69894	45	79253	166	85822	121,126	94008	69
62014	46	68328	23,29	69895	45	79255	166	85824	121,126	94012	84
62015	46	68329	23,29	69896	45	79256	166	85826	121,126	94026	69
62016	46	68330	23,29	69897	45	79800	73	85832	121,126	94199	69
62017	46	68331	23,29	69898	45	79801	73	85836	121,126	94224	69
62018	46	68332	31	69901	45	79802	73	85842	121,126	95013	168
62022	46	68333	31	69902	45	79803	73	85844	121,126	95014	168
62023	46	68334	31	69903	45	79804	73	85850	121,126	95016	134
62024	46	68335	31	69904	45	79805	73	85852	121,126	95027	94
62025	46	68336	31	69905	45	79810	73	85854	121,126	95028	94
62026	46	68337	31	70068	151	79811	73	85860	121,126	95029	94
62027	46	68338	31	70208	153	79812	73	85862	121,126	95084	94
62028	46	68339	31	70209	153	79813	73	85900	121,126	95129	94
62032	46	68340	30	70210	153	79814	73	85901	121,126	95151	168
62033	46	68341	30	70211	153	79815	73	85908	121,126	95202	93
62034	46	68342	30	70212	153	83000	129	85912	121,126	95203	93
62035	46	68343	30	70215	153	83002	131	85914	121,126	95301	94
62036	46	68344	30	70300	156	83003	131	85920	121,126	95502	175
62037	46	68345	30	70304	156	83004	131	85922	121,126	95563	94
62038	46	68346	30	70308	156	83005	131	85930	121,126	95566	94
62052	46	68347	30	70312	151,159	83006	131	85932	121,126	95567	94
62053	46	68348	30	70324	156	83007	131	85946	121,126	95660	94
62054	46	68349	30	70325	156	83010	129	85938	121,126	95665	94
62055	46	68350	22,26	71019	157	83011	129	85940	121,126	95925	170
62056	46	68351	26	71076	164	83030	129	85948	121,126	96702	179
62057	46	68352	22,26	71077	157	83040	129	85978	121,126	96705	89
62058	46	68353	22,26	71078	157	83050	129	85981	121,126	99307	78
62062	46	68354	26	71079	157	83070	129	85995	121,126	99346	82
62063	46	68355	22,26	71080	157	83100	129	85996	121,126	99383	168
62064	46	68356	22,26	71081	157	83110	129	85997	121,126	99551	78
62065	46	68357	26	72034	160	83111	129	86013	121,126	99553	78
62066	46	68358	22,26	72058	160	83116	131	86014	121,126	99554	100
62067	46	68359	22,26	72086	161	83130	129	86017	120,127	99593	159
62068	46	68360	26	72101	161	83140	129	86098	120,127	99594	162
62072	46	68361	22,26	73050	164	83150	129	86099	120,127	99694	94
62073	46	68362	22,26	73054	22,26	83180	131	86100	120,127	99714	94
62074	46	68364	22,26	73055	164	83190	131	86101	120,127	99786	94
62075	46	68365	23,29	73111	160,166	83300	131	86102	120,127	99788	94
62076	46	68366	31	73146	159	83310	131	86103	120,127	99791	94
62077	46	68370	27	73156	159	83330	131	86104	120,127	99801	175
62078	46	68371	27	73180	152	83340	131	86105	120,127	99805	175
62082	46	68372	27	73182	152	83350	131	86106	121,126	99806	175
62083	46	68373	27	73195	165	83393	131	86107	121,126	99823	89
62084	46	68374	27	73217	167	83394	128	86108	121,126	99825	89
62085	46	68375	27	73218	167	83405	128	86109	121,126		
62086	46	68376	27	73233	161	83430	131	86110	121,126		
62087	46	68377	27	74002	165	83440	131	86111	121,126		
62088	46	68378	27	74004	165	83450	131	86112	121,126		
65205	52	68379	27	74015	166	83513	129	86113	121,126		
65206	52	68380	27	74020	165	83514	129	86114	121,126		
65207	52	68381	27	74048	165	83515	129	86115	121,126		
65208	52	68382	27	74053	165	83516	129	86116	121,126		
65209	52	68383	27	74078	166	83550	131	86117	121,126		
65210	52	68384	27	75000	162	83630	131	86120	121,126		
65212	52	68385	27	75060	162	83640	131	86121	121,126		
65213	52	68386	27	75068	161	83715	129	86122	121,126		
65218	52	68387	27	75085	162	83716	129	86125	121,126		
65219	52	68388	27	75096	163	83717	129	86123	121,126		
65220	52	68389	27	75097	163	83718	129	86124	121,126		
65221	52	68390	27	75098	163	83740	131	86126	121,126		
65222	52	68391	27	75102	163	83750	131	86127	121,126		
65223	52	68392	27	75103	163	83910	131	86128	121,126		
65225	52	68393	27	75104	163	83930	131	86129	121,126		
65226	52	68400	26	75105	163	83940	131	86130	121,126		
65231	52	68401	30	75109	163	83950	131	86131	121,126		
65232	52	68402	30	75110	163	83999	132	86132	121,126		
65233	52	68403	28	75117	164	84640	131	86133	121,126		
65234	52	68404	29	75118	164	84710	131	86134	121,126		
65235	52	68405	29	75130	163	84730	131	86135	121,126		
65236	52	68406	29	75131	163	84740	131	86136	121,126		
65238	52	69850	45	75132	163	84750	131	86137	121,126		
65239	52	69851	45	75133	164	84926	128	86138	121,126		
68069	26	69852	45	75137	164	84925	128	86139	121,126		
68300	23,28	69853	45	75138	164	84941	128	86140	121,126		
68301	23,28	69854	45	75140	163	85014	129	86141	121,126		
68302	23,28	69857	45	75160	156	85150	131	86142	121,126		
68303	23,28	69858	45	75170	163	85153	131	86143	121,126		
68304	23,28	69859	45	75171	163	85156	131	86148	121,126		
68305	23,28	69860	45	75172	163	85440	131	86150	121,126		

THE WEILER PROMISE

At Weiler, we passionately embrace change to improve our products and our processes to move the company and our customers forward. By bringing new ideas and creative problem solving together in an open, collaborative environment, we will improve our customers' productivity and create profitable growth.



WEILER ABRASIVES GROUP

Weiler Global HQ
One Weiler Drive
Cresco, PA 18326 USA

Weiler de México
Querétaro, México

Weiler do Brasil
São Paulo, Brazil

Weiler EMEA HQ
Maribor, Slovenia

Zreče, Slovenia

Loče, Slovenia

Oplotnica, Slovenia

Bindlach, Germany