

Stockholm 2-Pc LHF Chaise Sectional Assembly Instruction

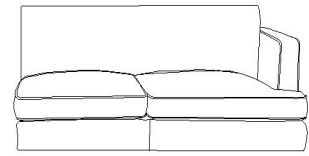

RHF loveseat (A)

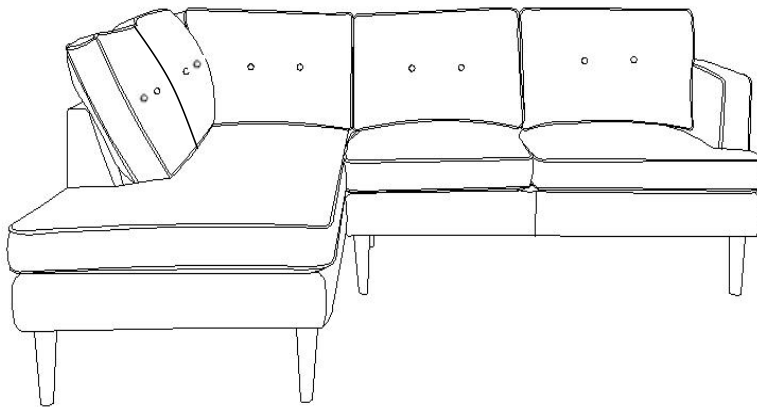
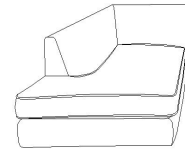

LHF chaise (B)

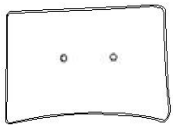

Loveseat back cushion 2pc (C1)

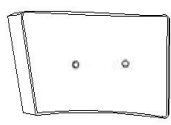

Chaise back cushion 1pc (C2)

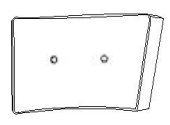

Chaise back cushion 1pc (C3)

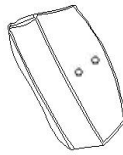

Chaise back cushion 1pc (C4)

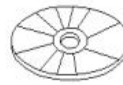

Plastic washer 9pcs (C)

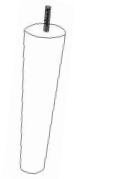

Leg 8pcs (D)

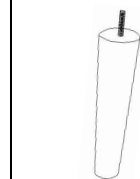

Middle leg 1pc (E)

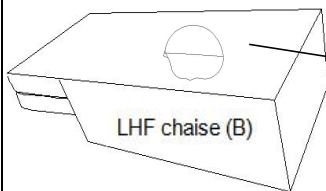

LHF chaise (B)

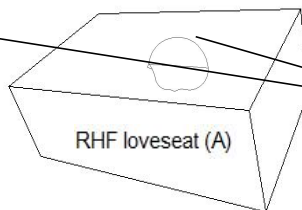

RHF loveseat (A)

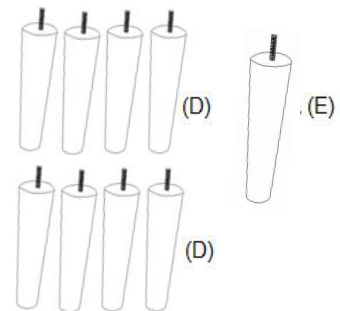

Step 1. Turn over the RHF loveseat (A) & LHF chaise (B) then open the bottom cover as the picture shown, take out the leg (D) & (E) from here .

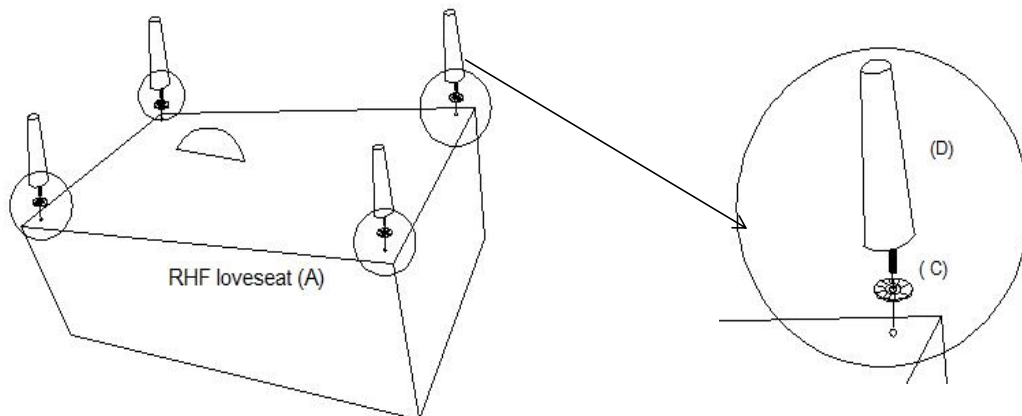

Step 2. Install the leg (D) to the RHF loveseat (A) with the Plastic washer (C) one by one as the picture shown .

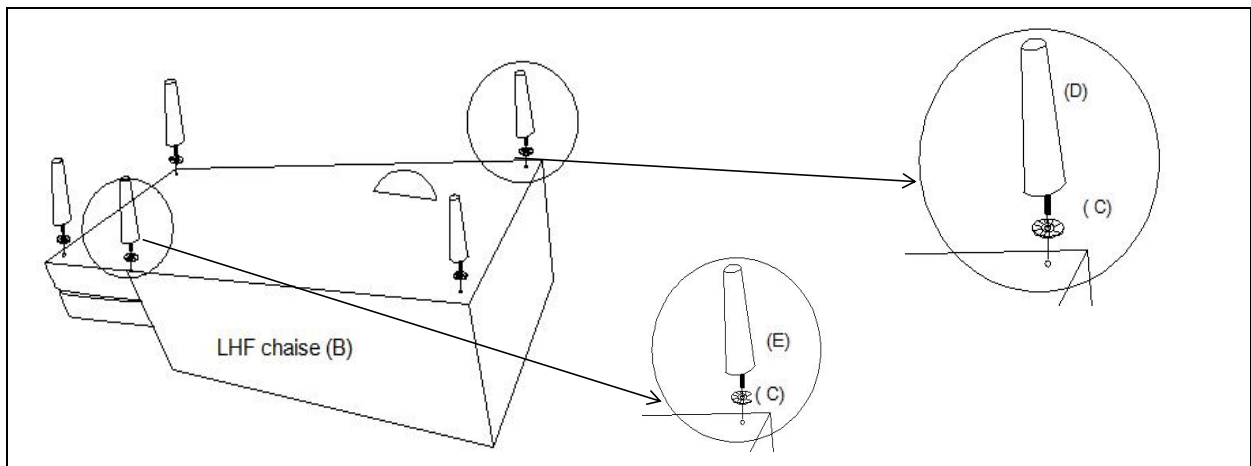

Step 3. Install the leg (D) & middle leg (E) to the LHF chaise (B) with the Plastic washer (C) one by one as the picture shown .

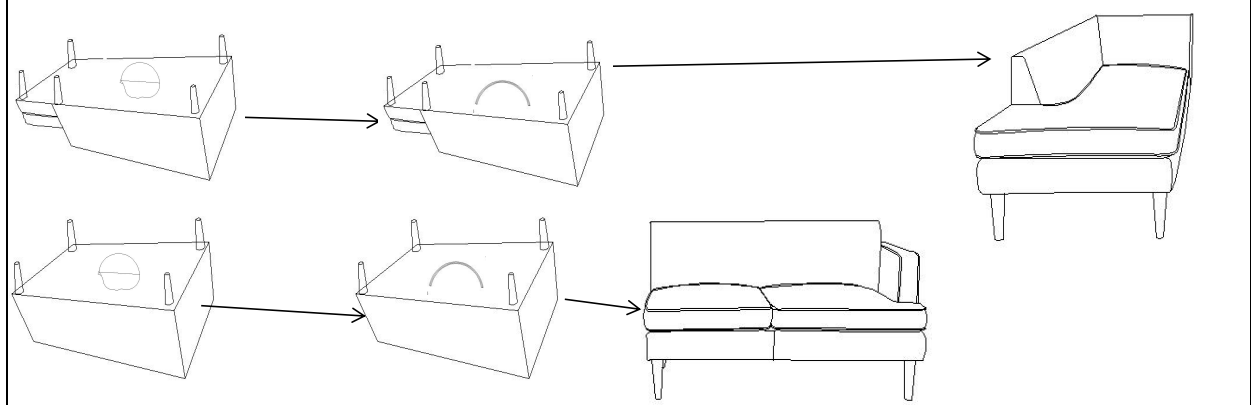

Step 4. Zip on the bottom cover and turn over your RHF loveseat (A) & LHF chaise (B) together as the picture shown.

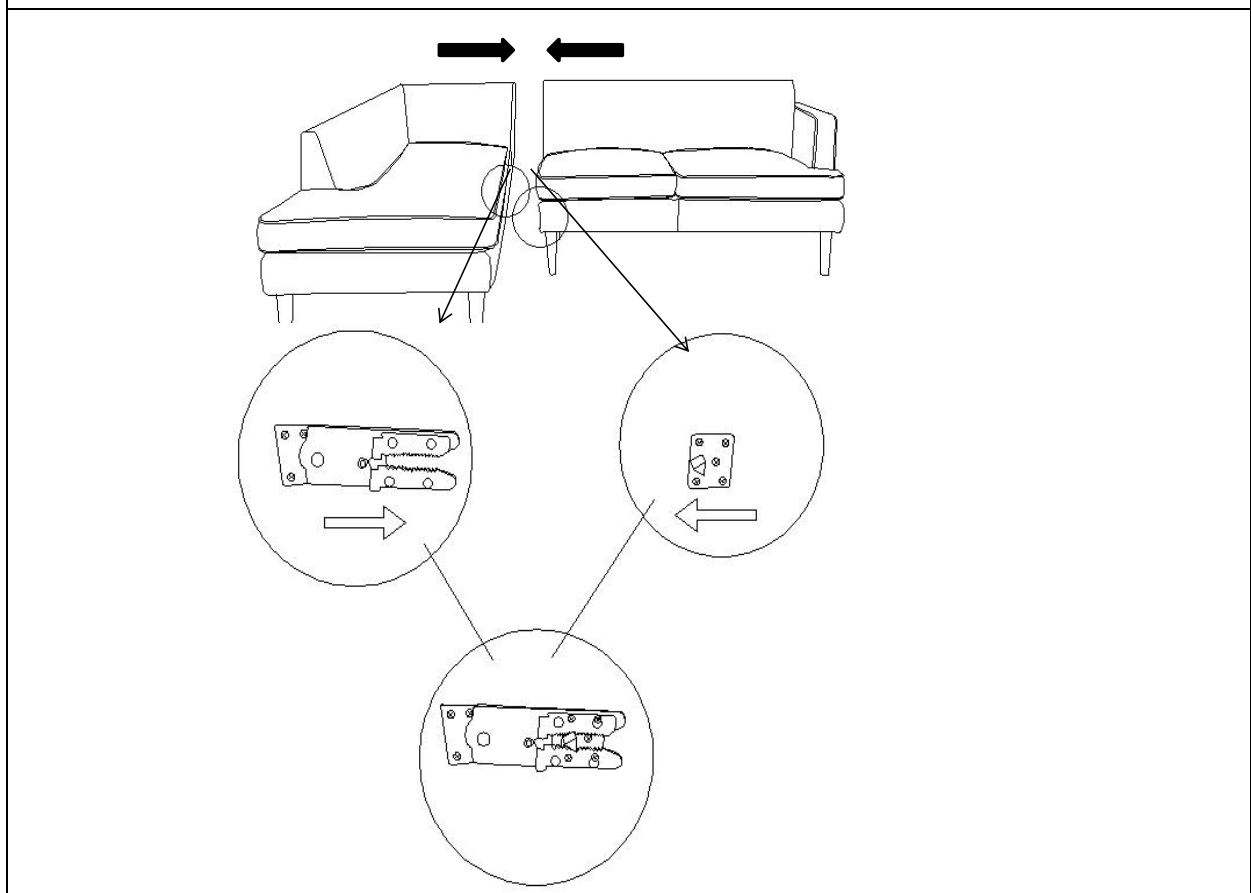

Step 5. Lock the RHF loveseat & LHF chaise by pushing one against another, to make them jointed by the metal connector.

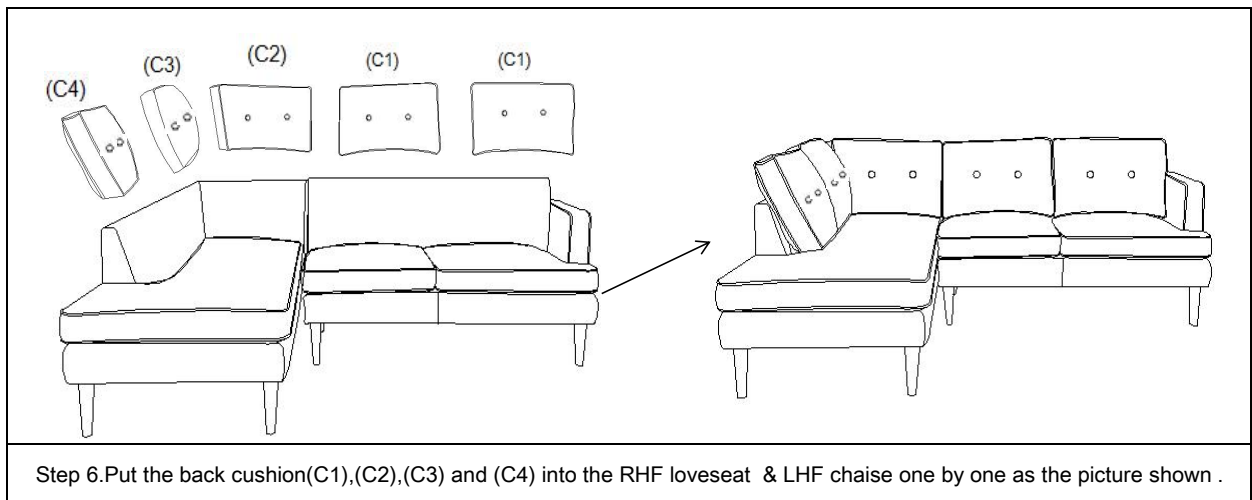

Step 6.Put the back cushion(C1),(C2),(C3) and (C4) into the RHF loveseat & LHF chaise one by one as the picture shown .