

HINTS & TIPS

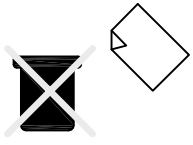

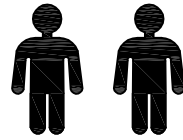

Please retain this assembly instruction for future use.

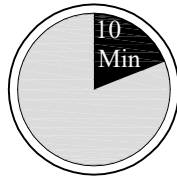

This assembly requires two people

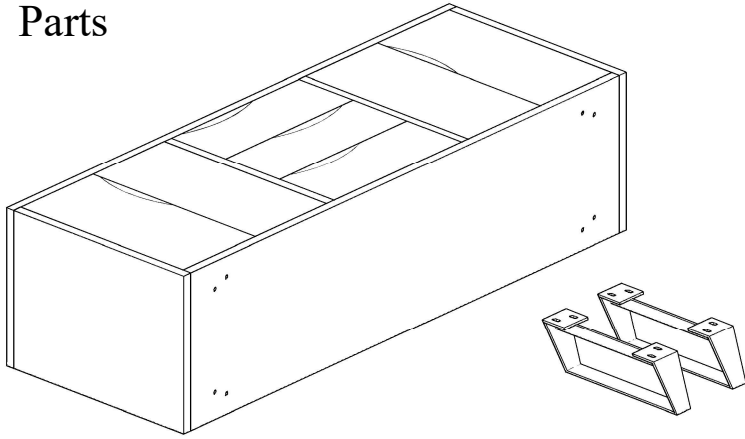
Parts

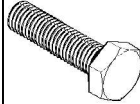
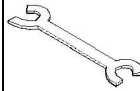

Code	Description	Qty
1	 Flat Washer	08
2	 Bolt	08
3	 Wrench	01

