

DOWN EAST

ASSEMBLY INSTRUCTION MADSEN DINING TABLE (11069)





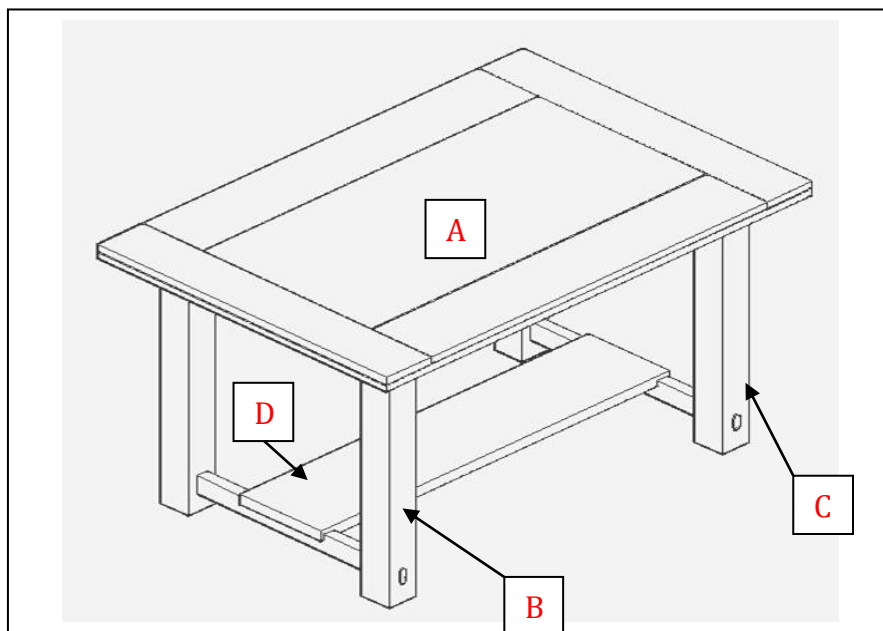

- ! Do not throw away packaging materials until assembly is complete.
- ! Assemble this item on a soft surface, such as cardboard or carpet, to protect finish.
- ! Proper assembly of this item requires 2 people & would require approx 20 minutes to assemble.

CARE INSTRUCTIONS

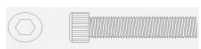
Wipe with a soft, dry cloth. To protect finish, avoid the use of chemicals and household cleaners. Any liquid spilled onto the table should be cleaned up immediately with a damp cloth.

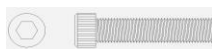
PARTS

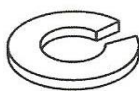

E  Allen Bolt M8, 35mm, 6x + 1 Extra	F  Allen Bolt M8, 50mm, 4x +1 Extra	G  Allen Bolt M8, 60mm, 8x +1 Extra
H  Washer 25mm 18x + 1Extra	I  Spring Washer 18x + 1Extra	J  Allen Key 1 x

Step1 - Lay the Table top panel (A) upside down on to a clean smooth surface.

Step2 - Take one side leg assembly (Like B) and match it with its respective side.

The slots on the Top and legs are numbered. Match the number on the leg assembly with that on the Top, while attaching.

Step3 - Now, Insert Allen Bolt (E) for the rail & (F) for the corner with washer (H) & spring washer (I).

And fully Tighten with Allen Key (J). Repeat the same step for Leg assembly (C).

Step4 - Match the fixing holes on side & mid structure and attached with bolt (G) with plain washer (H) & spring washer (I) using Allen key (J).

Step5 - Turn the **Table** upright. **Table** is now ready to use

