

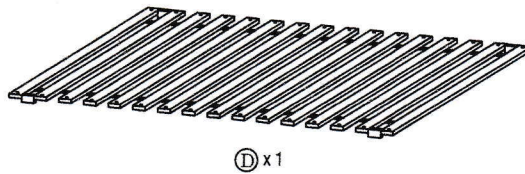

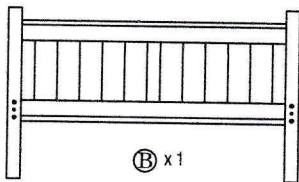

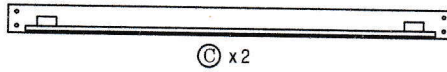

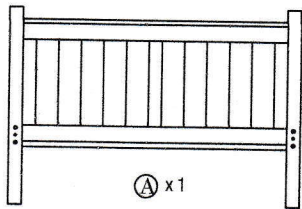

# DE Kid's Carolina Cottage Twin Bed

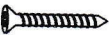

1. x8  M6 x 130mm	2. x1  ALLEN KEY	3. x8  M6 x 13mm	4. x4  M8 x 30mm	5. x32  M4 x 32mm
--	---	---	---	---

# DE Kid's Carolina Cottage Twin Bed

1

- 1.  x 8  
M6 x 130mm
- 2.  x 1
- 3.  x 8  
M6 x 13mm
- 4.  x 4  
M8 x 30mm

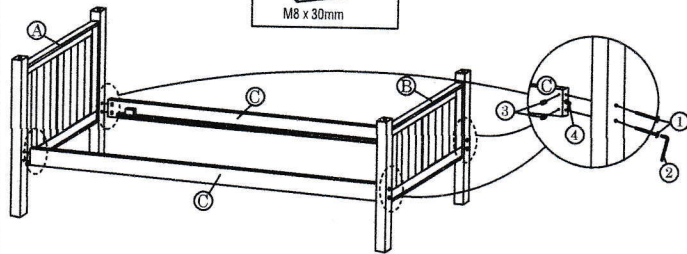

2

- 5.  x 32  
M4 x 32mm

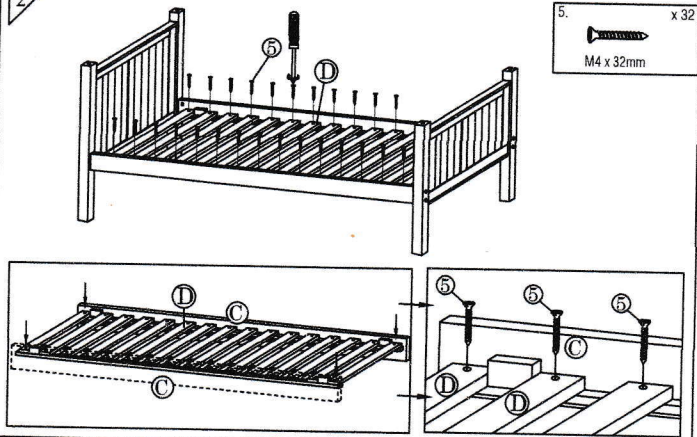

3

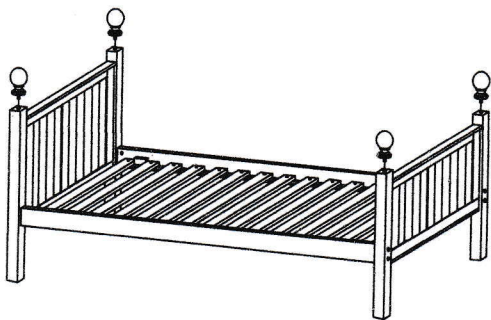

4

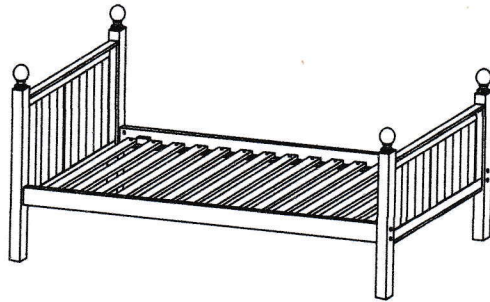

The End

2/2