

# Down East Blair Dining Table- Assembly Instruction

## Hardware

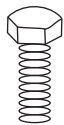

**A**  
10x

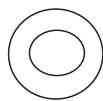

**B**  
10x

## Tools Required

Power tools NOT recommended



## Components

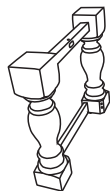

**C**  
2x



**D**  
1x

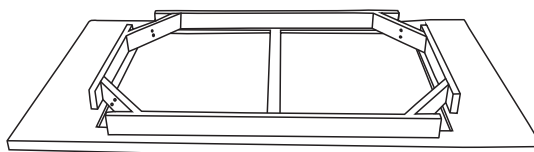

**E**  
1x

## Assembly Instructions

**1**

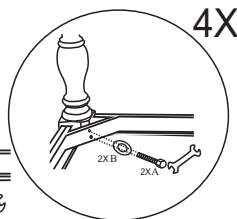
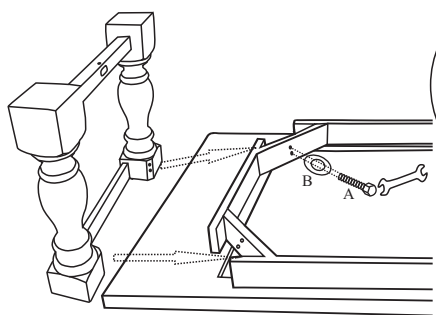

4X

**2**

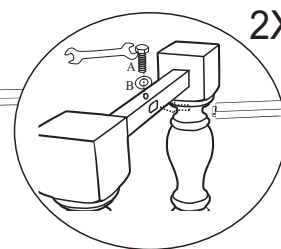
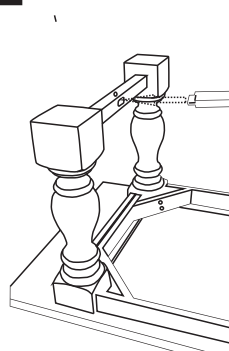

2X

**3**

