

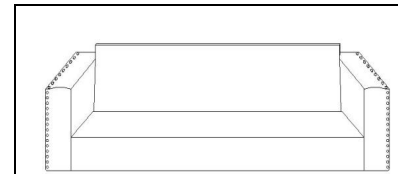

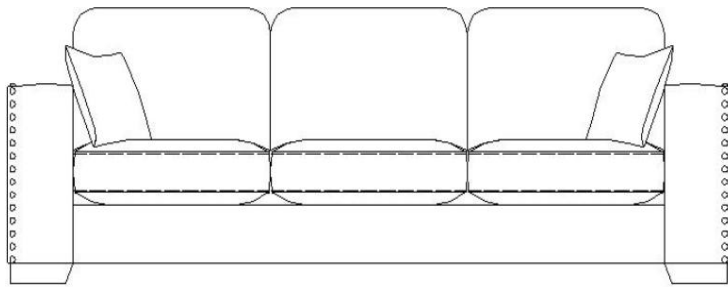





# Anthony Sofa Assembly Instruction

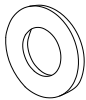

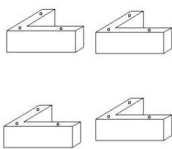
Sofa 1pc (A)

 sizes:M8*60mm	 size:Ø 22mm	 M8	 6mm		
Inner hexagon screw (a) 8pcs	Flat washer(b) 8pcs	Bent washer(c) 8pcs	Allen Key (d) 1pc	Leg 4pcs (E)	Seat cushion 3pcs (B)
					
Back cushion 3pcs (C)	Pillow 2pcs (D)				

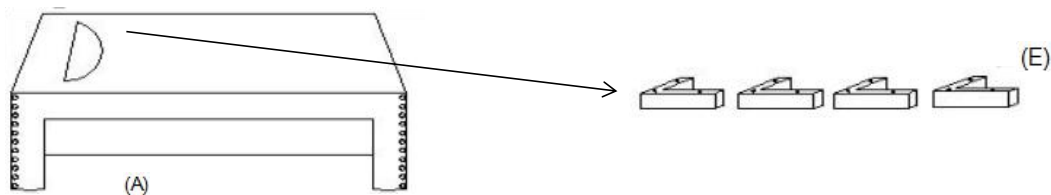

Step 1. Turn over the Sofa (A) and open the bottom cover as the picture shown, then take out the leg (E) from here .

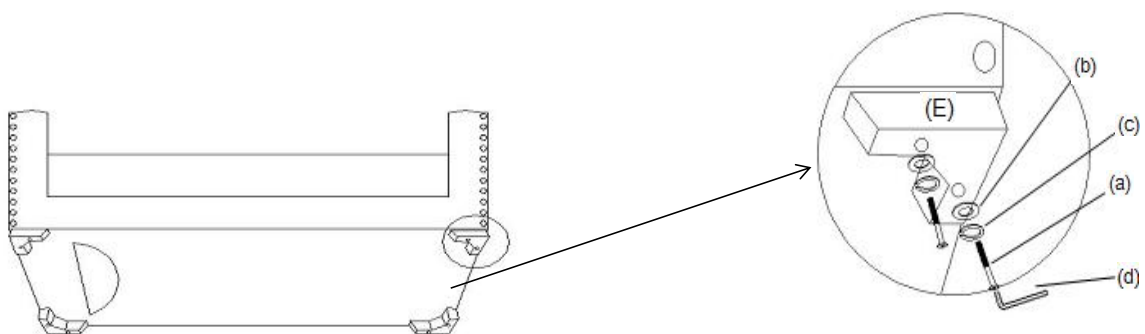

Step 2. Install the Leg (E) to the Sofa (A) with Flat washer (b) , Bent washer (c) , Inner hexagon screw (a) by Allen key (d) one by one .

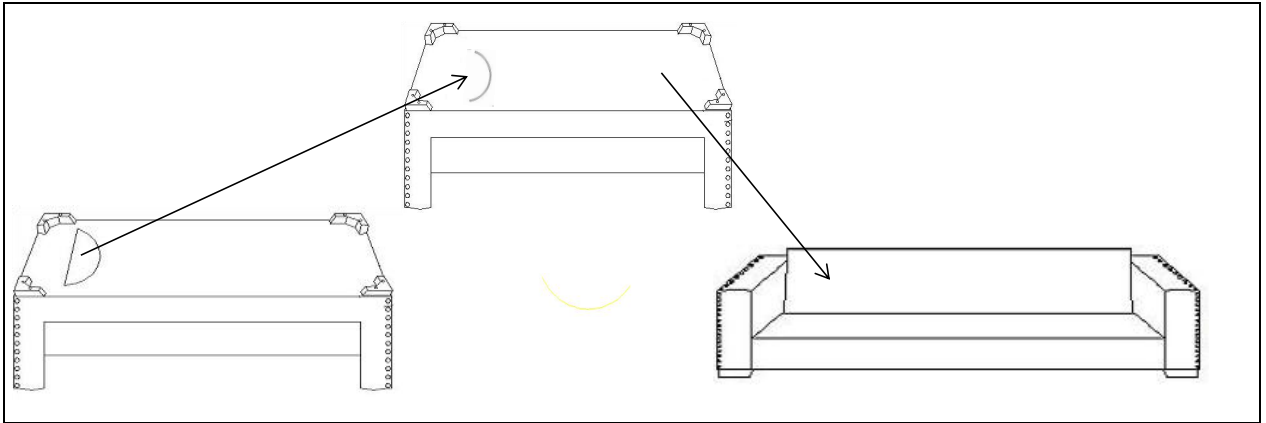

Step 3. Zip on the bottom cover and turn over your sofa as the picture shown.

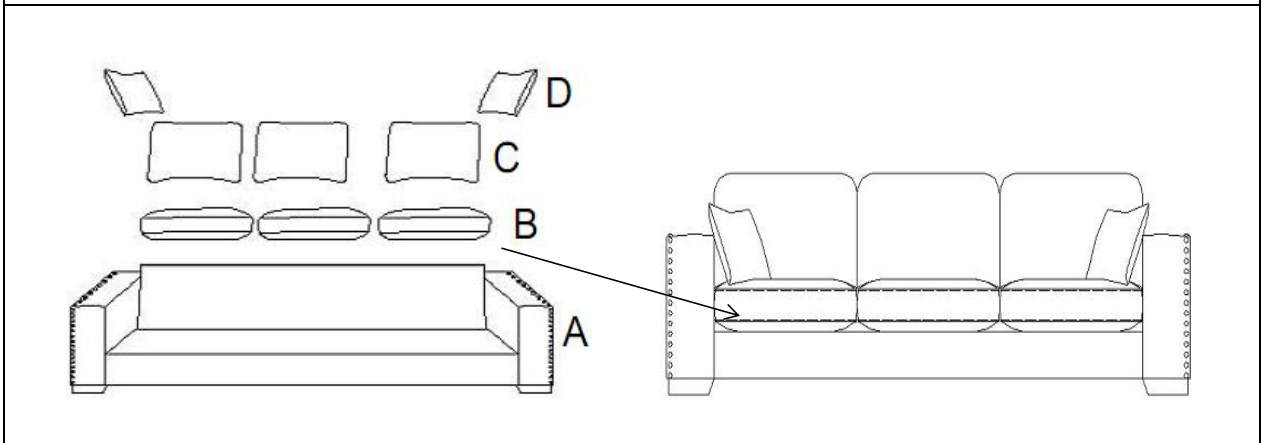





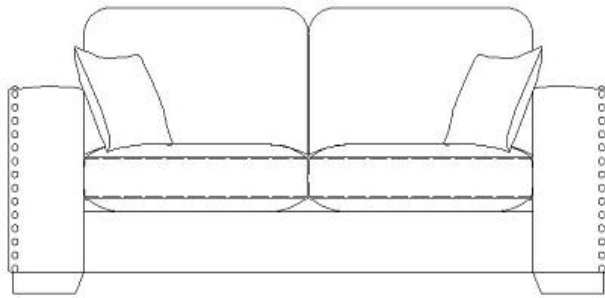

Step 4. Put the Seat cushion (B), Back cushion (C) and the Pillow (D) into the sofa one by one as the picture shown

# Anthony Loveseat Assembly Instruction

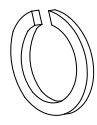

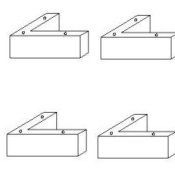
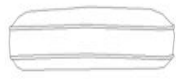
Loveseat 1pc (A)

 sizes:M8*60mm	 size:Ø 22mm	 M8	 6mm		
Inner hexagon screw (a) 8pcs	Flat washer(b) 8pcs	Bent washer(c) 8pcs	Allen Key (d) 1pc	Leg 4pcs (E)	Seat cushion 2pcs (B)
					
Back cushion 2pcs (C)	Pillow 2pcs (D)				

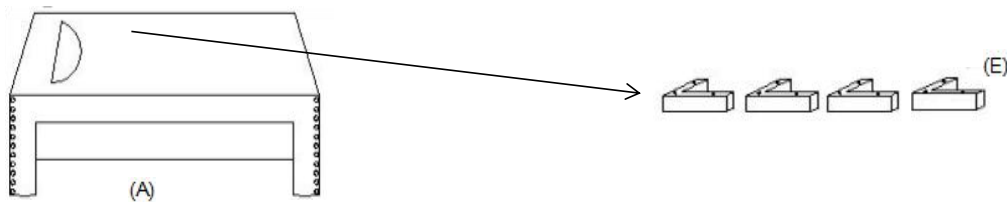

Step 1. Turn over the Loveseat(A) and open the bottom cover as the picture shown, then take out the leg (E) from here .

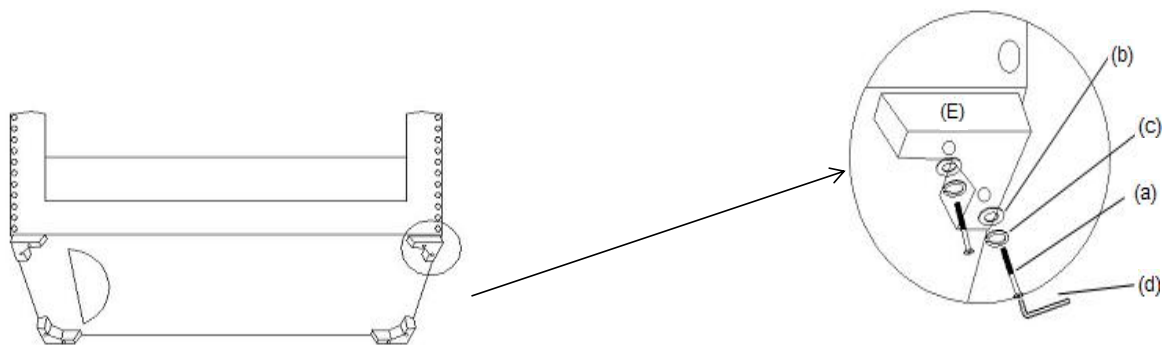

Step 2. Install the Leg (E) to the Loveseat (A) with Flat washer (b) , Bent washer (c), Inner hexagon screw (a) by Allen key (d) one by one .

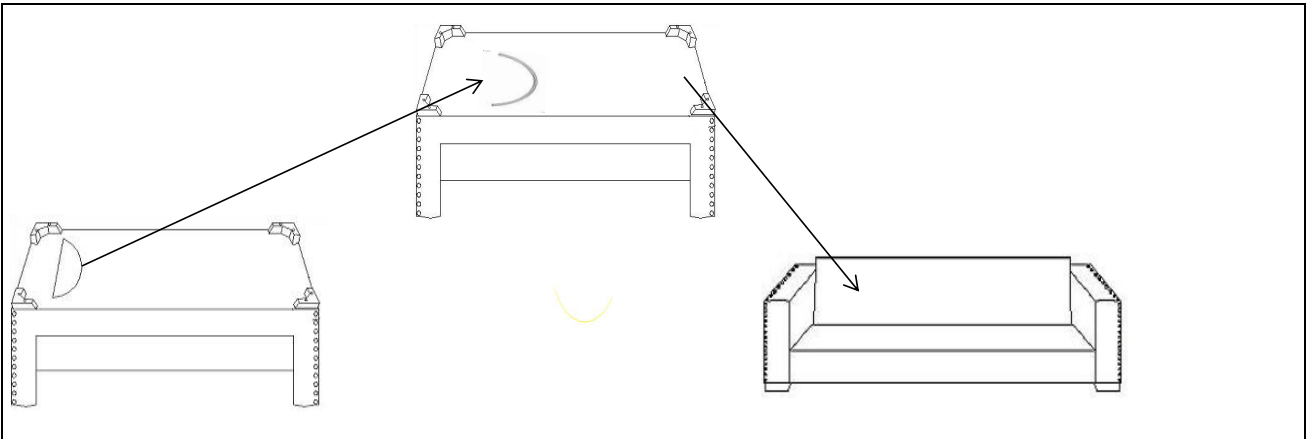

Step 3. Zip on the bottom cover and turn over your loveseat as the picture shown.

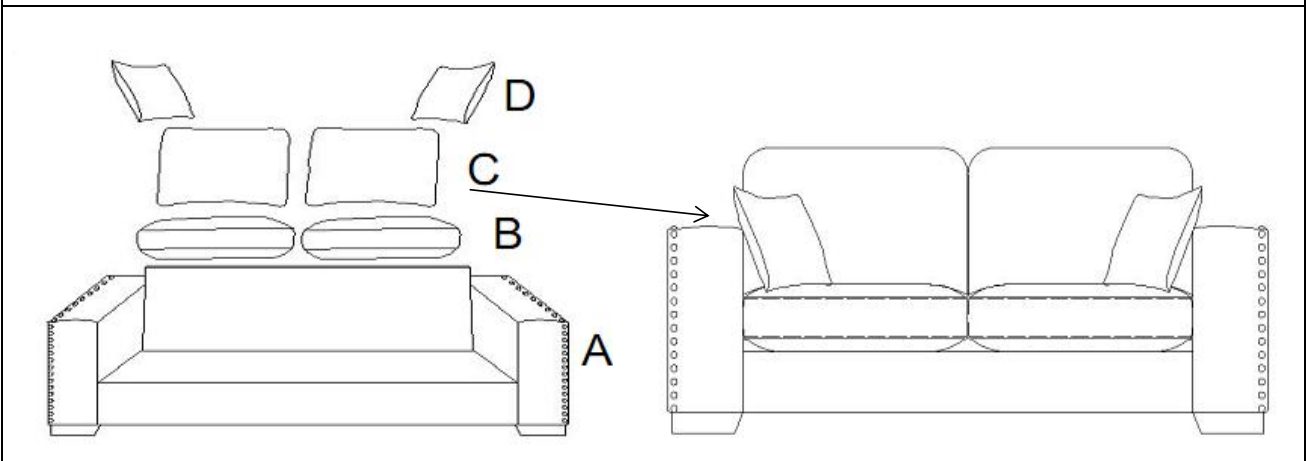

Step 4. Put the Seat cushion (B), Back cushion (C) and the Pillow (D) into the loveseat one by one as the picture shown

# Anthony Chair Assembly Instruction

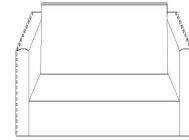
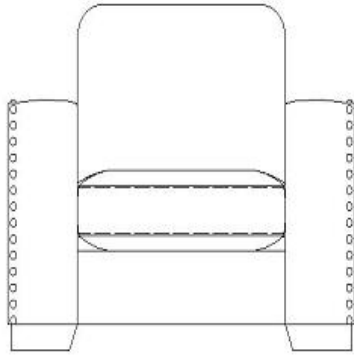

Chair 1pc (A)



sizes:M8\*60mm



size:Ø 22mm



M8



6mm

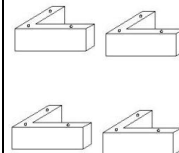

Leg 4pcs (E)



Seat cushion 1pc (B)



Back cushion 1pc (C)

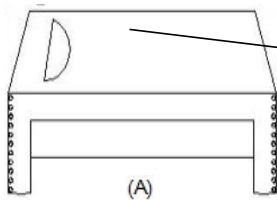

Step 1. Turn over the Chair(A) and open the bottom cover as the picture shown, then take out the leg (E) from here .

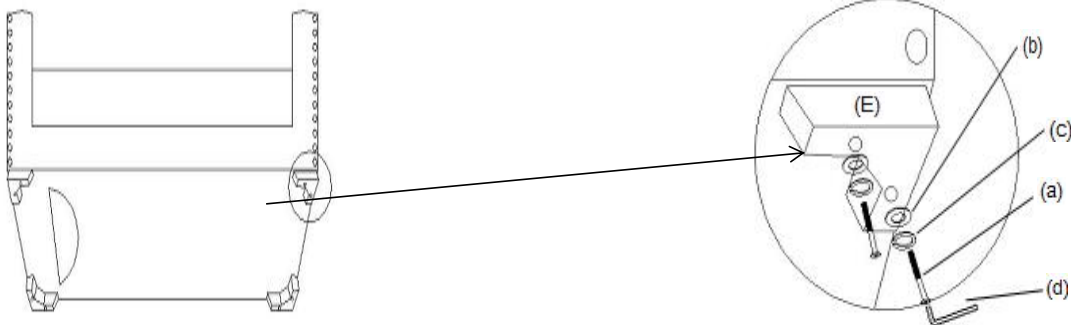

Step 2. Install the Leg (E) to the Chair (A) with Flat washer (b) , Bent washer (c) , Inner hexagon screw (a) by Allen key (d) one by one .

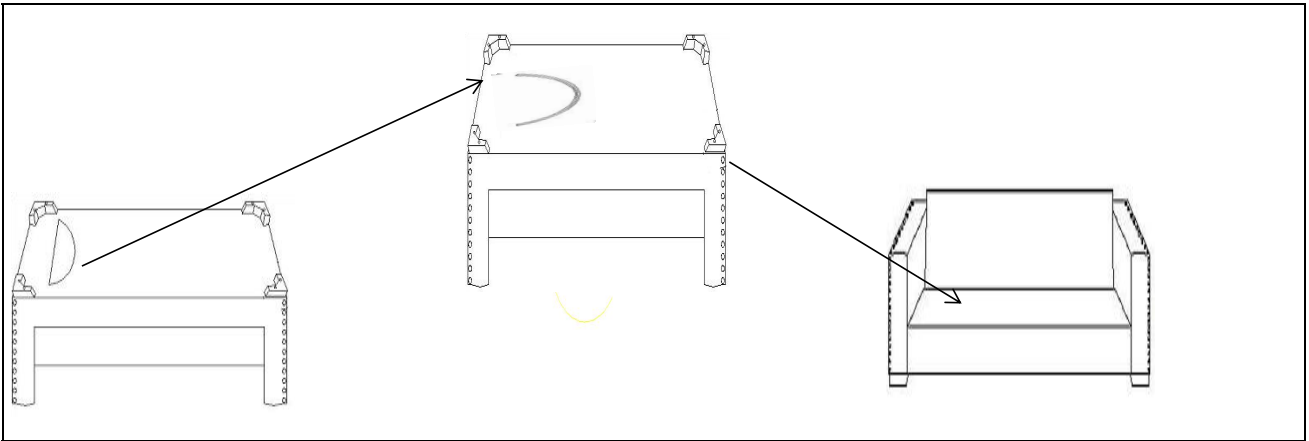

Step 3.Zip on the bottom cover and turn over your chair as the picture shown.

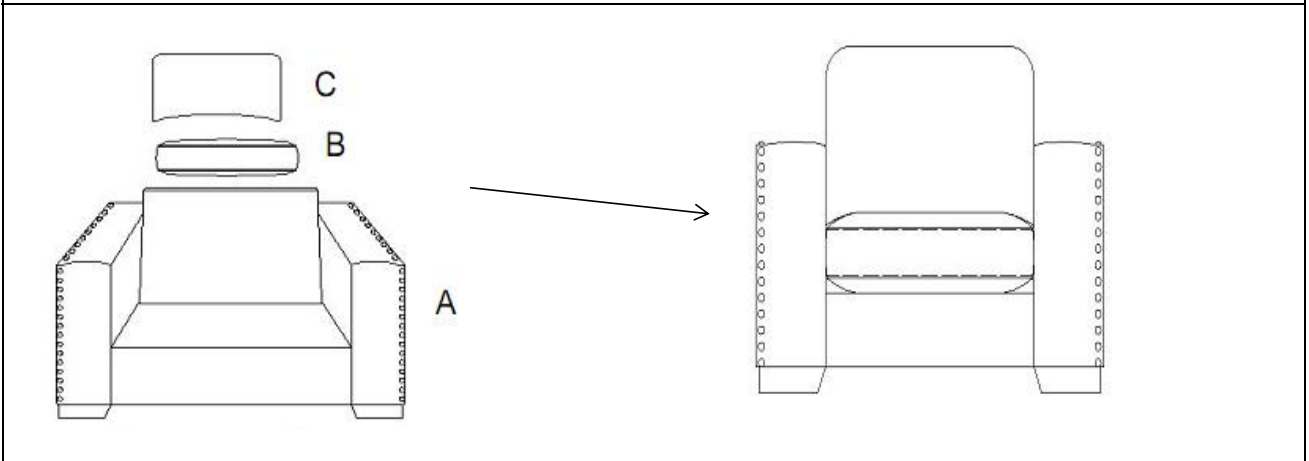

Step 4.Put the Seat cushion ( B),Back cushion ( C ) into the chair one by one as the picture shown .