



PARKING
PRO SHOP.COM
1844-787-7595



PARKING
CATALOG
2024



U.S. Small Business
Administration

WOSB CERTIFIED

Contents

4.	CornerStone® - ANSI 107 Class 2 Safety T-Shirt	Uniforms
5.	Valet Polo	
6.	Valet Tee	
7.	Performance Polo	
8.	Performance Polo	
9.	Caps	
10.	Fleece, Hats	
11.	Jackets	
12.	Jackets	
13-15.	Vests	
16.	Rain Coat	
17.	Parking Pro Valet Keybox	Signage
18.	Parking Signage	
19.	Vinyl Banners	
20.	Valet Podium Sign Packages	
21.	Parking Hang Tags	
22.	Graphic Reflective Delineator	
23.	Intersection Signs	
24.	Disabled Parking Signs	
25.	Permissive Parking Signs	
26.	Restrictive Traffic Prohibition Signs	
27.	In-Street Pedestrian Crosswalk Signage	
28.	Facility Signs	
29.	Tip and Roll Snap Frame Stanchion	Parking Garage Supplies
30.	Sign Stanchion	
31.	Overhanging Led Light Fixture	
32.	Snap frames, A frames, Windmasters	
33.	Windmaster	
34.	Letrapole	
35.	Parking Warning Signs	
36.	Wheel Dolly	
37.	Convex Mirrors	
38.	Bicycle Racks	
39.	Bike-Shell	
40-42.	Wheel Stops, Speed Bumps and Humps	
43-44.	Corner and Wall Cushions	
45.	Ceiling Leak Diverter	
46.	Clearance Bars	
47-50.	Bollards	
51-55.	Bollard Covers	
56.	Jump Packs and Cables, Lockout Tool Kit	
57.	Wheel Clamp, Wheel Boot	
58.	Bases	Valet Accessories
59.	Sign Systems	
60.	Keyboard	
61.	Acrylic Portable Tip Box	

Contents

62.	Flags and Wands	Cones & Traffic Control
63.	Custom Traffic Barricade	
64.	FlexPost-XL™ ACCESSORIES	
65.	Accessories	
66.	FLEXPOST-SM™ PRODUCTS	
67.	FlexPost-SM™ Accessories	
68-74.	Delineators	
75.	Plastic Chains	
76.	Parking Meter Hoods	Parking Maintenance Supplies
77.	Tickets	
78-101.	CABLE AND HOSE PROTECTORS-FULL LINE	
102-110.	VEHICLE AND MOTION SAFETY	
111.	Parking Pro Shop – Closed Circuit Television Solutions (CCTV)	
112.	Surgical Mask & Face Cover	
113.	Bioprotect™ Hydrating Hand Sanitizer	
114.	Dispenser	
115.	BIOPROTECT	
116.	SmartTouch Disinfectant	
117.	Washroom/Restroom Accessories	
118.	Washroom/Restroom Accessories	
119.	Washroom/Restroom Accessories	
120.	Trash Cans, Recycling Stations and Receptacles	
121.	Wipes and Dispenser - Janitorial	
122.	Odor Control	
123.	Storage and Shelving	
124.	Storage and Shelving	
125.	Car Cover	
126.	Parking Maintenance Services	
127.	Paint and Epoxy	
128.	PORTABLE SAFETY AND SECURITY MIRROR	
129.	Sign Conversion	
130.	Calcium Chloride Pellets	
131.	Spill Kit	
132.	Safe Smoker & Butt Cans	
133.	Car Charging	
134.	Pressure Washers	
135.	Snow Blowers	
136.	Bird and Rodent Control	
137-146.	Stencils	



CS401-Y

Stay safer on the jobsite in this high-visibility t-shirt that works as hard as you do.

- ANSI/ISEA 107 Class 2 certified
- 5.9-ounce, 100% polyester interlock
- Wicks moisture
- 2-in. wide reflective taping on front and back
- Left chest pocket for pens and notes



CS401-O

\$21.99 ea

YOUR LOGO INCLUDED

min order 50 units

Valet Polo



K100LS

Long Sleeve Core Classic Pique Polo.

An indispensable polo for just about every uniforming need. Designed for everyday wear, this pique polo is made from a durable blend for lived-in comfort, traditional good looks and exceptional value.

- 4.4-ounce, 60/40 cotton/poly pique
- Flat knit collar and cuffs
- 3-button placket with dyed-to-match buttons
- Side vents

AVAILABLE COLORS:

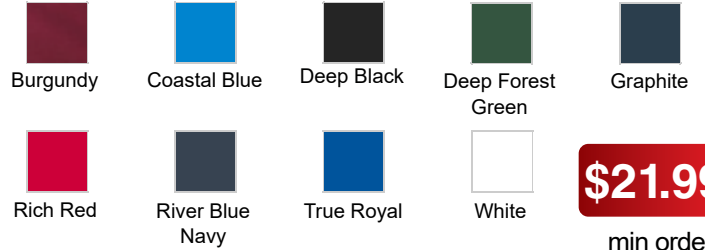

\$21.99

min order
50 units



K100

Core Classic Pique Polo.

An indispensable polo for just about every uniforming need. Designed for everyday wear, this pique polo is made from a durable blend for lived-in comfort, traditional good looks and exceptional value.

- 4.4-ounce, 60/40 cotton/poly pique
- Flat knit collar and cuffs
- 3-button/4-button placket with dyed-to-match buttons
- Side vents

AVAILABLE COLORS:

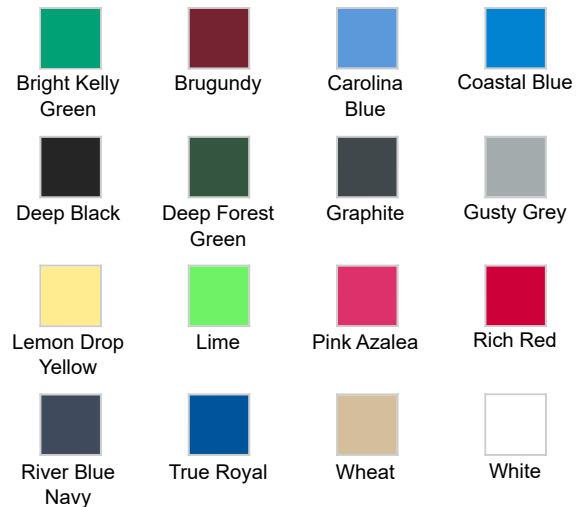

\$16.99

min order
50 units



L100

\$16.99

min order
50 units

Call to Order **516-825-0727**
Or Visit Us On-Line
Parkingproshop.com
Bulk Pricing Available



Valet Tee



PC55

Port & Company® - Core Blend Tee . PC55

A reliable choice for comfort, softness and durability.

- 5.5-ounce, 50/50 cotton/poly
- Made with up to 5% recycled polyester from plastic bottles

Due to the nature of 50/50 cotton/polyester neon fabrics, special care must be taken throughout the printing process. Adult Sizes: S-6XI

AVAILABLE COLORS:



\$10.99

min order
50 units



LPC55

Port & Company® Ladies Core Blend Tee. LPC55

A reliable choice for comfort, softness and durability.

- 5.5-ounce, 50/50 cotton/poly
- Made with up to 5% recycled polyester from plastic bottles
- Side seamed with a contoured body for a feminine fit

Due to the nature of cotton/polyester blends in dark and neon colors, special care must be taken throughout the decoration process when heat is applied for curing. Please consult with your decorator or material supplier.

AVAILABLE COLORS:

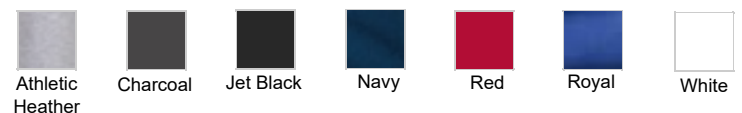

\$10.99

min order
24 units

Performance Polo



Colors:



The durable Silk Touch Performance Polo wicks moisture, resists snags and holds onto its color for a professional look that lasts.

- 4oz, 100% polyester double knit with PosiCharge technology
- Self-fabric collar
- Tag-free label
- 3-button placket with dyed-to-match buttons
- Set in, open cuff sleeves
- Double-needle sleeve cuffs and hem

\$17.99

Min
order
36 Unit

**YOUR LOGO
INCLUDED**

Call to Order **516-825-0727**
Or Visit Us On-Line
Parkingproshop.com
Bulk Pricing Available



Performance Polo



Port Authority® Silk Touch™ Performance Long Sleeve Polo



- 4-ounce, 100% polyester double knit with PosiCharge technology; White is 4.3-ounce for increased coverage
- Self-fabric collar
- Tag-free label
- 3-button placket with dyed-to-match buttons
- Set in, open cuff sleeves
- Double-needle sleeve cuffs and hem

\$19.99 YOUR LOGO INCLUDED

K540LS Min order 36

Sport-Tek® Ladies PosiCharge® Competitor™ Polo



- 3.8-ounce, 100% polyester interlock with PosiCharge technology
- Gently contoured silhouette
- Flat knit collar
- Removable tag for comfort and relabeling
- Taped neck
- Elongated 2-button placket with dyed-to-match buttons
- Set-in, open hem sleeves

\$17.99 YOUR LOGO INCLUDED

LST550 Min order 24

Port Authority® Ladies Pinpoint Mesh 1/2-Zip



- 4.3-ounce, 100% polyester
- Cadet collar
- Dyed-to-match zipper
- Set-in sleeves
- Front and back princess seams
- Open cuffs and hem
- Slightly rounded hem

\$25.99 YOUR LOGO INCLUDED

L806 Min order 24

Port Authority® Silk Touch™ Performance Colorblock Stripe Polo



- 4-ounce, 100% polyester double knit with PosiCharge technology; White is 4.3-ounce for increased coverage
- Self-fabric collar
- Tag-free label
- 3-button placket with dyed-to-match buttons
- Set in, open cuff sleeves
- Double-needle sleeve cuffs and hem

\$19.99 YOUR LOGO INCLUDED

K547 Min order 36

Port Authority® Ladies Silk Touch™ Performance Colorblock Stripe Polo



- 4-ounce, 100% polyester double knit with PosiCharge technology; White is 4.3-ounce for increased coverage
- Self-fabric collar
- Tag-free label
- 3-button Y-placket with dyed-to-match buttons
- Set in, open cuff sleeves
- Double-needle sleeve cuffs and hem

\$19.99 YOUR LOGO INCLUDED

L547 Min order 24

Caps



C919

Port & Company® Unstructured Sandwich Bill Cap



- Fabric 100% cotton twill
- Structure Unstructured
- Profile Low
- Closure Hook and loop

\$9.99

YOUR LOGO INCLUDED

Min order 25



C911

Port Authority® Adjustable Mesh Back Cap



- Fabric: 100% cotton twill front panels; 100% polyester mesh mid and back panels
- Structure: Structured
- Profile: Mid
- Closure: Low-profile hook and loop

\$10.99

YOUR LOGO INCLUDED

Min order 25



C829

Port Authority® Americana Flag Sandwich Cap



- Fabric: 100% cotton twill
- Structure: Structured
- Profile: Low
- Closure: Hook and loop

\$11.50

YOUR LOGO INCLUDED

Min order 25



C112

Port Authority® Snapback Trucker Cap



- Fabric: 100% cotton twill front panels; 100% polyester mesh mid and back panels
- Structure: Structured
- Profile: Mid
- Closure: 7-position adjustable snap

\$11.50

YOUR LOGO INCLUDED

Min order 25



STC11

Sport-Tek® Dry Zone® Nylon Colorblock Cap



- Fabric: 91/9 nylon/cotton twill
- Structure: Structured
- Profile: Mid
- Closure: Hook and loop

\$12.99

YOUR LOGO INCLUDED

Min order 25

Call to Order **516-825-0727**
Or Visit Us On-Line
Parkingproshop.com
Bulk Pricing Available



Fleece



Port Authority® Value Fleece Vest



F219

- 13.8-ounce, 100% polyester
- Twill-taped neck
- Reverse coil zipper
- Chin guard
- Bungee cord zipper pulls
- Tricot-lined armholes
- Front zippered pockets
- Open hem with drawcord and toggles for adjustability

\$25.99 YOUR LOGO INCLUDED

Min order 36



Port Authority® Value Fleece 1/4-Zip Pullover



F218

- 13.8-ounce, 100% polyester
- Twill-taped neck
- Reverse coil zipper
- Chin guard
- Bungee cord zipper pull
- Open cuffs
- Open hem with drawcord and toggles for adjustability

\$27.99 YOUR LOGO INCLUDED

Min order 36



Port Authority® Ladies Microfleece Jacket

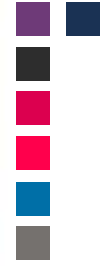

L223

- 7.5-ounce, 100% polyester microfleece
- 100% polyester tricot pockets
- Non-zippered front pockets
- Open cuffs and hem

\$27.99 YOUR LOGO INCLUDED

Min order 24

Hats



CP94

Port & Company® - Knit Skull Cap



- Fabric: 100% acrylic

\$8.99 YOUR LOGO INCLUDED

Min order 25



C908

Port Authority® Watch Cap



- Fabric: 100% acrylic

\$10.99 YOUR LOGO INCLUDED

Min order 25



STC20

Sport-Tek® Spectator Beanie



- Fabric: 100% acrylic

\$10.50 YOUR LOGO INCLUDED

Min order 25



CS800

CornerStone® - Enhanced Visibility Beanie with Reflective Strip



- Fabric: 99/ 1 acrylic/ other

\$13.99 YOUR LOGO INCLUDED

Min order 25

Jackets



**Port Authority®
Zephyr Full-Zip
Jacket**

J344

- 100% polyester shell
- Zip-through cadet collar with chin guard
- Set-in sleeves
- Elastic binding at cuffs and hem
- Open front pockets



\$21.99 YOUR LOGO INCLUDED

Min order 36



**Port Authority®
Ladies Zephyr
Full-Zip Jacket**

L344

- 100% polyester shell
- Zip-through cadet collar with chin guard
- Set-in sleeves
- Elastic binding at cuffs and hem
- Open front pockets



\$21.99 YOUR LOGO INCLUDED

Min order 24



**Port Authority®
Zephyr Reflective
HiT Full-Zip Jacke**

J345

- 100% polyester shell
- Zip-through cadet collar
- Set-in sleeves
- Open front pockets
- Elastic binding at cuffs and hem



\$27.99 YOUR LOGO INCLUDED

Min order 36



**Port Authority®
Ladies Zephyr
Reflective HiT
Full-Zip Jacket**

L345

- 100% polyester shell
- Zip-through cadet collar with partial ruching
- Set-in sleeves
- Open front pockets
- Elastic binding at cuffs and hem



\$27.99 YOUR LOGO INCLUDED

Min order 24



**Port Authority®
Lightweight
Charger Jacket**

J329

- 100% polyester Taslan shell
- 100% polyester lightweight fleece body lining
- 100% polyester sleeve lining
- Front zippered pockets
- Vislon® zipper
- Interior pocket
- Port Pocket™ for easy embroidery access
- Elastic cuffs with adjustable self-fabric tabs and hook and loop closures
- Elastic waistband



\$32.99 YOUR LOGO INCLUDED

Min order 36



**Port Authority®
Ladies Active
Soft Shell Jacket**

L717

- 100% polyester knit shell bonded to a water-resistant film insert and a 100% polyester mesh interior
- 1000MM fabric waterproof rating
- 1000G/M2 fabric breathability rating
- Zip-through cadet collar with chin guard
- Reverse coil zipper
- Front zippered pockets
- Elastic binding at cuffs
- Open hem with adjustable locking drawcord



\$33.99 YOUR LOGO INCLUDED

Min order 24



**Port Authority®
Core Soft Shell
Jacket**

J317

- 100% polyester woven shell bonded to a water-resistant film insert and a 100% polyester microfleece lining
- 92/8 poly/spandex woven shell bonded to a water-resistant film insert and a 100% polyester microfleece lining (Heathers)
- 1000MM fabric waterproof rating
- 1000G/M2 fabric breathability rating
- Zip-through cadet collar with chin guard
- Reverse coil zippers
- Front zippered pockets
- Open cuffs and hem



\$39.99 YOUR LOGO INCLUDED

Min order 36



**Port Authority®
Charger Jacket**

J328

- 100% polyester Taslan shell
- 100% polyester fleece body lining
- 100% polyester heavyweight sleeve lining with 3-ounce polyfill
- Vislon® zipper
- Front zippered pockets
- Interior pocket
- Rib knit cuffs and waistband
- Port Pocket™ for easy embroidery access



\$39.99 YOUR LOGO INCLUDED

Min order 36

Call to Order **516-825-0727**
Or Visit Us On-Line
Parkingproshop.com
Bulk Pricing Available



Jackets



**Port Authority®
Ladies Core Soft
Shell Jacket**

L317

- 100% polyester woven shell bonded to a water-resistant film insert and a 100% polyester microfleece lining
- 92/8 poly/spandex woven shell bonded to a water-resistant film insert and a 100% polyester microfleece lining (Heathers)
- 1000MM fabric waterproof rating
- 1000G/M2 fabric breathability rating
- Zip-through cadet collar with chin guard
- Reverse coil zippers
- Front zippered pockets
- Open cuffs and hem



\$39.99 YOUR LOGO INCLUDED

Min order 24



**Port Authority®
Challenger™
Jacket**

J754

- Teklon® nylon outer shell
- Vision zipper
- Poly-filled body with heavyweight fleece lining for extra warmth
- Poly-filled sleeves with polyester lining
- Rib knit cuffs and waistband
- Slash zippered pockets, interior zippered pocket
- Port Pockets™ for easy embroidery access
- *Due to the Tyvek inner lining, a silk screen or heat transfer treatment is not recommended.



\$50.99 YOUR LOGO INCLUDED

Min order 36



**Red Kap® Team
Style Jacket with
Slash Pockets**

CSJT38

- 7.25-ounce, 65/35 poly/cotton twill
- Permanently lined
- 1x1 rib knit collar, cuffs and waistband
- Two lower inset slash pockets
- Utility pocket on left sleeve



\$50.99 YOUR LOGO INCLUDED

Min order 36



**Port Authority®
Challenger™
Jacket with
Reflective
Taping**

J754R

- Teklon® nylon outer shell
- Vision zipper
- Poly-filled body with heavyweight fleece lining for extra warmth
- Poly-filled sleeves with polyester lining
- 1-in. wide reflective taping on front, back and sleeves
- Rib knit cuffs and waistband
- Slash zippered pockets, interior zippered pocket
- Port Pockets™ for easy embroidery access



\$57.99 YOUR LOGO INCLUDED

Min order 36



**Port Authority®
All-Conditions
Jacket**

J331

- 100% polyester with DWR finish
- 7-ounce, polyester fleece inner body lining
- 2-ounce polyfill in sleeves
- 3000MM fabric waterproof rating
- 3000G/M2 fabric breathability rating
- Adjustable hood with locking drawcord to customize fit
- Waterproof chest pocket with locking zipper pull
- Front zippered pockets
- Full-length exterior storm flap with snap closures
- Self-fabric adjustable tab cuffs with hook and loop closures
- Port Pocket™ for easy embroidery access
- Open hem with drawcord and toggles



\$58.99 YOUR LOGO INCLUDED

Min order 36



**Port Authority®
Herringbone
3-in-1 Parka**

J302

- 100% polyester
- 8000MM fabric waterproof rating
- Fully seam-sealed for additional waterproof protection
- 3000G/M² fabric breathability rating
- Detachable hood with drawcord and toggles for adjustability
- Zippered chest pocket
- Front zippered pockets
- External storm flaps with hook and loop closure
- Self-fabric adjustable cuffs with hook and loop closures
- Inner jacket has front zippered pockets, inner zippered chest pocket, Lycra binding at neck and cuffs
- Open hem with drawcord and toggles for adjustability



\$97.99 YOUR LOGO INCLUDED

Min order 36



**Port Authority®
Colorblock 3-in-1
Jacket**

J321

- 100% polyester shell
- 3-ounce polyfill in body and sleeves
- 3,000 MM fabric waterproof rating
- 1,000 G/M2 fabric breathability rating
- Zip-off hood with locking drawcords for adjustability
- Exterior storm flap with snap closure
- Reverse coil zippered chest pocket
- Port Pocket™ in outer shell for easy embroidery access
- Front zippered pockets
- Adjustable self-fabric tab cuffs with hook and loop closures
- Open hem
- Liner jacket has sherpa-like fleece lining



\$88.99 YOUR LOGO INCLUDED

Min order 36



**Port Authority®
Heavyweight
Parka**

J799

- 100% polyester shell, 100% polyester quilted lining
- 8000MM fabric waterproof rating
- Fully seam-sealed for added waterproof protection
- 3000G/M² fabric breathability rating
- Snap-off adjustable hood
- Storm flap
- Two-way zipper with ergonomic pull
- Waterproof welded sleeve pocket
- Waterproof zippered pockets
- Hand warmer pocket
- Bellow pockets for storage
- Molded adjustable tab cuffs with hook and loop closures
- Interior media pocket
- Open hem with drawcord and toggles
- Port Pocket™ for easy embroidery access



\$124.99 YOUR LOGO INCLUDED

Min order 24

VESTS

V40 COLORS

●	Black	SM 28601	MD 28602	LG 28603	XL 28604
		2X 28605	3X 28606	4X 82972	5X 82973
●	BURGUNDY	SM 28621	MD 28622	LG 28623	XL 28624
		2X 28625	3X 28626	4X 82974	5X 82975
●	HUNTER GREEN	SM 28651	MD 28652	LG 28653	XL 28654
		2X 28655	3X 28656	4X 82976	5X 82977
●	KHAKI	SM 28671	MD 28672	LG 28673	XL 28674
		2X 28675	3X 28676	4X 82978	5X 82979
●	NAVY	SM 28631	MD 28632	LG 28633	XL 28634
		2X 28635	3X 28636	4X 82980	5X 82981
●	RED	SM 28641	MD 28642	LG 28643	XL 28644
		2X 28645	3X 28646	4X 82982	5X 82983
●	ROYAL BLUE	SM 28611	MD 28612	LG 28613	XL 28614
		2X 28615	3X 28616	4X 82984	5X 82985

V40 Chest Pocket Unisex Vest

Chest pocket with pencil stall and four color-matched buttons. Bound edges for finished appearance.

65/35 poly/cotton twill

SM - 5X



\$15.99
EMBROIDERY
INCLUDED

V65 COLORS

●	Black	SM 23323	MD 23324	LG 23325	XL 23326
		2X 23327	3X 23328	4X 82994	5X 82995
●	BROWN	SM 83265	MD 83266	LG 83267	XL 83268
		2X 83269	3X 83270	4X 83271	5X 83272
●	BURGUNDY	SM 23329	MD 23330	LG 23331	XL 23332
		2X 23333	3X 23334	4X 82996	5X 82997
●	HUNTER GREEN	SM 23293	MD 23294	LG 23295	XL 23296
		2X 23297	3X 23298	4X 82998	5X 82999
●	NAVY	SM 23299	MD 23300	LG 23301	XL 23302
		2X 23303	3X 23304	4X 83000	5X 83001
●	PURPLE	SM 83336	MD 83337	LG 83338	XL 83339
		2X 83340	3X 83341	4X 83342	5X 83343
●	RED	SM 23305	MD 23306	LG 23307	XL 23308
		2X 23309	3X 23310	4X 83002	5X 83003
●	ROYAL BLUE	SM 23311	MD 23312	LG 23313	XL 23314
		2X 23315	3X 23316	4X 83004	5X 83005

V65 Two Pocket Unisex Vest

Tailored finished facing, two separate patch pockets at waist-level and four color-matched buttons. Bound edges for finished appearance.

65/35 poly/cotton twill

SM - 5X



\$18.99
EMBROIDERY
INCLUDED

Call to Order **516-825-0727**
Or Visit Us On-Line
Parkingproshop.com
Bulk Pricing Available



VESTS

V41 Men's Regular Fitted Vest | V41L Men's Tall Fitted Vest

Tailored finished facing, two mock welt waist-level pockets and four color-matched buttons.

65/35 poly/cotton twill

SM - 5X

Ideal for caterers, event staff



V41

\$21.99

EMBROIDERY INCLUDED

V41L

\$24.99

EMBROIDERY INCLUDED

MEASUREMENTS

	V41 (Regular)		V41L (Tall)
	Back Length	Chest	Back Length
XS	21.25"	18"	-
SM	21.5"	18.5"	24.25"
MD	22"	20"	25"
LG	22.5"	22"	25.5"
XL	23"	24"	26"
2X	23.5"	26"	26.5"
3X	24"	28"	27.25"
4X	24.5"	30"	-
5X	25"	32"	-
6X	25.5"	34"	-

V41 - REGULAR

BLACK

● SM 23335	MD 23336	LG 23337	XL 23338
● 2X 23339	3X 28406	4X 82986	5X 82987

V41L - TALL

BLACK

● SM 82542	MD 82543	LG 82544	XL 82545
● 2X 82546	3X 82547	4X 82988	5X 82989

V42 Women's Petite Vest | V42L Women's Regular Vest

Classic form-fitting shape, tailored finished facing, princess seams and four color-matched buttons.

65/35 poly/cotton twill

SM - 5X

Ideal for caterers, event staff



V42

\$21.99

EMBROIDERY INCLUDED

V42L

\$24.99

EMBROIDERY INCLUDED

MEASUREMENTS

	V42 (Petite)		V42L (Regular)
	Back Length	Chest	Back Length
XS	18"	17.75"	-
SM	18.5"	18.5"	20.5"
MD	19"	19"	21"
LG	19.5"	19.75"	21.5"
XL	20.25"	20.5"	22.25"
2X	20.75"	21.25"	22.75"
3X	21.5"	22"	23.5"
4X	22.25"	22.25"	-
5X	23"	23.25"	-

V42 - PETITE

BLACK

● SM 23340	MD 23341	LG 23342	XL 23343
● 2X 23344	3X 23345	4X 82990	5X 82991

V42L - REGULAR

BLACK

● SM 82548	MD 82549	LG 82550	XL 82551
● 2X 82552	3X 82553	4X 82992	5X 82993

VESTS

V93 Two Pocket Women's Tunic Vest

Longer length tunic-style vest with princess seams for a form-fitting shape, tailored finished facing, two waist-level pockets and five color-matched buttons.

65/35 poly/cotton twill

SM - 5X

V93 COLORS

BLACK
SM 81231 **MD** 81232 **LG** 81233 **XL** 81234
2X 81235 **3X** 81236 **4X** 83006 **5X** 83007

BURGUNDY
SM 81246 **MD** 81247 **LG** 81248 **XL** 81249
2X 81250 **3X** 81251 **4X** 83008 **5X** 83009

HUNTER GREEN
SM 81252 **MD** 81253 **LG** 81254 **XL** 81255
2X 81256 **3X** 81257 **4X** 83010 **5X** 83011

PURPLE
SM 83345 **MD** 83346 **LG** 83347 **XL** 83348
2X 83349 **3X** 83350 **4X** 83351 **5X** 83352

ROYAL BLUE
SM 83453 **MD** 83454 **LG** 83455 **XL** 83456
2X 83457 **3X** 83458 **4X** 83459 **5X** 83460



\$20.99

**EMBROIDERY
INCLUDED**

Call to Order **516-825-0727**
 Or Visit Us On-Line
Parkingproshop.com
 Bulk Pricing Available

P **PARKING**
PROSHOP.COM
 516-825-0727





Rain Coat

The Classic series material is the most popular in the Industry. It combines the strength and waterproof qualities of PVC with the durability of a polyester backing. The 200C yellow 49" coat features a snap front, take up snaps at the wrists, detachable hood with drawstring, and 2 patch pockets. Come back to the Classics for your protective wear needs.

MCR Safety 200C

- **.35 mm PVC on polyester coat, yellow**
- **Detachable hood with drawstring**
- **Rounded collar of same material**
- **2 patch pockets on the front**
- **Cape ventilated back, underarm air vents**

\$19.99 ea

Key Box

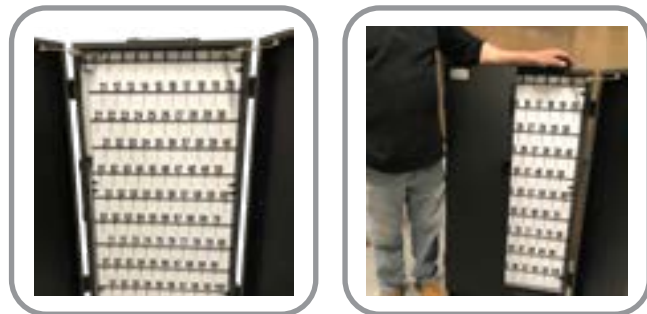

Capacity: 200/100/50 Keys

48 Key FOBS (optional)

Size:

100/200 keys: 48"x24"x4"

50 keys: 24"x24"

Features:

- Spring Loaded Doors with Soft Close Support
- Ultra Durable Welded Key Ring Hook Grid
- 3-1/2 in. Black Key Locking Hasp
- 3" TPR Rigid Plate Caster (optional)
- Portable Stick-on Battery Operated 32-LED Fixture With Wireless Motion and Light Sensor
- Heavy Duty 10" Strap On Handles with Spring Steel Insert
- Latex Printed Numbering With Scratch Proof Lamination
- Black Rigid Structural 12mm Dura-Foam Body With Matte Finish
- Key FOB pockets (optional)

KEYBOX 200 **\$466.00**

KEYBOX 100 **\$346.00**

KEYBOX 50 **\$262.00**

WHEELS **\$30.00**

Call to Order **516-825-0727**
 Or Visit Us On-Line
Parkingproshop.com
 Bulk Pricing Available



Parking Signage

RATES				Garage Name	Address:	License #	Capacity 91	Hours of Operation 24Hrs/7Days
	Net	Tax	Gross					
Up to 2 hrs	\$ 23.65	\$ 4.35	\$ 28.00					
Up to 4 hrs	\$ 35.48	\$ 6.52	\$ 42.00					
Max to 24 Hrs	\$ 54.91	\$ 10.09	\$ 65.00					
Reg SUVs	\$ 12.67	\$ 2.33	\$ 15.00					
Large SUVs	\$ 16.90	\$ 3.10	\$ 20.00					
Monthly Rates								
Motorcycle Parking	\$ 211.19	\$ 38.81	\$ 250.00					
Regular Monthly	\$ 549.10	\$ 100.90	\$ 650.00					
Oversize	\$ 633.58	\$ 116.42	\$ 750.00					
Main Floor/Exotic	\$ 760.30	\$ 139.70	\$ 900.00					

NOTICE

Garage not responsible for any contents left in vehicle (cell phone, cash, etc) or bumper damage of any kind.

ANY DAMAGE CLAIMED MUST BE REPORTED TO GARAGE ATTENDANT BEFORE LEAVING AND AN INCIDENT REPORT MUST BE FILLED OUT ON SITE.

CUSTOMER MUST WAIT FOR GARAGE ATTENDANT TO ACCEPT AND INSPECT VEHICLE BEFORE LEAVING THE GARAGE. OTHERWISE GARAGE HAS NO RESPONSIBILITY FOR VEHICLE WHATSOEVER.

CUSTOMER MUST LEAVE IGNITION KEY IN VEHICLE AND TURN OFF ANY ALARMS. FAILURE TO DO SO WILL RESULT IN \$100 SURCHARGE.

Garage NOT RESPONSIBLE FOR MECHANICAL FAILURES OF ANY KIND.

Up to 1 hr 8.15
Up to 2 hrs 10.87
Up to 3 hrs 12.68
Up to 10 hrs 17.21
Up to 24 hrs 22.65
O'NITE Cars left after 6am 22.65
Early Bird In 6am-10am Out by 9pm 8.15
Suv's, Vans add'l Daily 9.06
10.375% Parking Tax Extra

If you have a complaint about this business, contact: NYC Department of Consumer Affairs, 42 Broadway, New York, NY 10004 DIAL 311 or www.nyc.gov/consumers

Licensee:
License Title(s):
License Number(s):

ATTENTION MANHATTAN RESIDENTS
IF YOU GARAGE YOUR CAR ON A MONTHLY BASIS OR LONGER, YOU MAY BE ELIGIBLE FOR AN EXEMPTION FROM THE 8% PARKING TAX SURCHARGE TO APPLY FOR A CERTIFICATE OF EXEMPTION CONTACT: NYC DEPARTMENT OF FINANCE PARKING TAX EXEMPTION SECTION 50 MADISON LANE, 16th FLOOR NY NY 10036 212-233-585 or 212-233-9442

NOTICE
Pursuant to law, operators liability for loss or damage of vehicle by fire, theft or explosion limited to \$25,000. No employee or Manager has the authority to modify or increase this liability.

ATTENTION MANHATTAN RESIDENTS: IF YOU GARAGE YOUR CAR ON A MONTHLY BASIS OR LONGER, YOU MAY BE ELIGIBLE FOR AN EXEMPTION FROM THE 8% PARKING TAX SURCHARGE TO APPLY FOR A CERTIFICATE OF EXEMPTION CONTACT: NYC DEPARTMENT OF FINANCE PARKING TAX EXEMPTION SECTION 50 MADISON LANE, 16th FLOOR NY NY 10036 212-233-585 or 212-233-9442

NOTICE
Pursuant to law, operator's liability for loss or damage of vehicle by fire, theft or explosion limited to \$25,000. No employee or Manager has the authority to modify or increase this liability.

P PARKING
WEEKEND SPECIAL
8.45 + tax
UPTO 12 HOURS
Not including Overnight

▼ **PARK** ▼

CLEARANCE 7'4"

↓ WELCOME - PULL AHEAD ↓

▶ 2 WAY TRAFFIC KEEP RIGHT ▶

Special
Any 3 hrs
 Max to Close
\$16.90
 +Tax



EVENT PARKING RATES

Cars _____ \$ 40
 Limos _____ \$ 50
 Buses _____ \$ 50

All above tax included
 Cash & Credit Cards Accepted
 *Special discounts available at TicketCity.com

WEEKEND

\$16.90

PLUS TAX
ENTER AFTER 6AM
UP TO 12 HOURS
EXIT BY 12AM
 OVERSIZE CHARGES ADD'L



- PVC
- ALUMINUM
- ACM
- PLEXI
- CORO
- REFLECTIVE
- ADA

Vinyl Banners



Vinyl Banners

- Full Color
- Front and back printing
- Standard 13oz
- Premium 15oz
- Nickel grommets
- Hemming

SIZE	Grommets every 2ft	Hemming
4'x8'	\$93.00	\$97.00



- FREE CUSTOM SIZE
- QUOTES UPON REQUEST

Our strongest, smoothest and most versatile banner material Matte finish Lasts about 5 years outdoors, in temperatures as low as -22°F. Fungus resistant. Offers the ultimate tear-resistance. Tensile strength: 285 x 239 lbs/inch



Mesh Banners

- Full Color
- Front print only
- Premium 9oz vinyl mesh
- Nickel grommets
- Hemming

SIZE	Grommets every 2ft
4'x8'	\$128.00



- FREE CUSTOM SIZE
- QUOTES UPON REQUEST

Allows 25% air-flow through. Tear resistant: 218.94 x 184.22 lbs/in tensile strength and 81.13 x 61.51 lbs/in tear strength. Can withstand outdoor temperatures as low as -4°F and as high as 176°F.

» Advertising outdoors can be challenging especially in windy conditions. Mesh banners have holes that allow wind to pass through. These holes also allow the viewer to see through the banner. «



- FREE GRAPHIC DESIGN

Call to Order **516-825-0727**
Or Visit Us On-Line
Parkingproshop.com
Bulk Pricing Available



Valet Podium Sign Packages

Smart Podium Reflective Signs

- 15"x36.5" **\$40** (magnetic)
- 15"x36.5" **\$30** (4mm coro)
- 3 sided
- 15"x36.5" + 17"x36.5" + 17"x36.5" **\$120** (magnetic)
- 15"x36.5" + 17"x36.5" + 17"x36.5" **\$100** (coro)

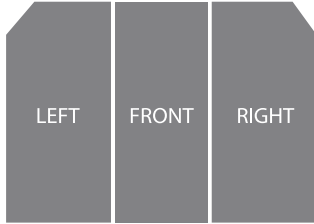

Elite Podium Reflective Signs

- 27"x42" **\$60** (magnetic)
- 27"x42" **\$50** (4mm coro)
- 3 sided
- 27"x42" + 19"x42" + 19"x42" **\$160** (magnetic)
- 27"x42" + 19"x42" + 19"x42" **\$140** (4mm coro)

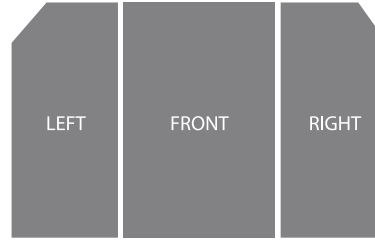

Standard Podium Reflective Signs

- 23"x42" **\$60** (magnetic)
- 23"x42" **\$50** (4mm coro)
- 3 sided
- 23"x42" + 17"x35" + 17"x35" **\$130** (magnetic)
- 23"x42" + 17"x35" + 17"x35" **\$110** (4mm coro)



Portable Podium Reflective Signs

- 21.75"x32.5" **\$45** (magnet)
- 21.75"x32.5" **\$35** (4mm coro)



Compact Podium Reflective Signs

- 17.5"x40.75" **\$45** (magnet)
- 17.5"x40.75" **\$35** (4mm coro)
- 3 sided
- 17.5"x40.75" + 18.5"x36" + 18.5"x36" **\$125** (magnetic)
- 17.5"x40.75" + 18.5"x36" + 18.5"x36" **\$105** (4mm coro)

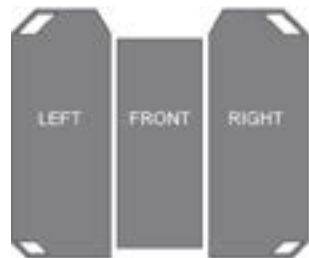

Classic Podium Reflective Signs

- 18"x42" **\$50** (magnetic)
- 18"x42" **\$40** (4mm coro)
- 3 sided
- 18"x42" + 18"x42" + 18"x42" **\$150** (magnetic)
- 18"x42" + 18"x42" + 18"x42" **\$120** (4mm coro)



Deluxe Podium Reflective Signage

- 24"x43" **\$60** (magnetic)
- 24"x43" **\$50** (4mm coro)
- 3 sides
- 24"x43" + 22"x43" + 22"x43" **\$180** (MAGNETIC)
- 24"x43" + 22"x43" + 22"x43" **\$150** (4MM CORO)



Parking Hang Tags

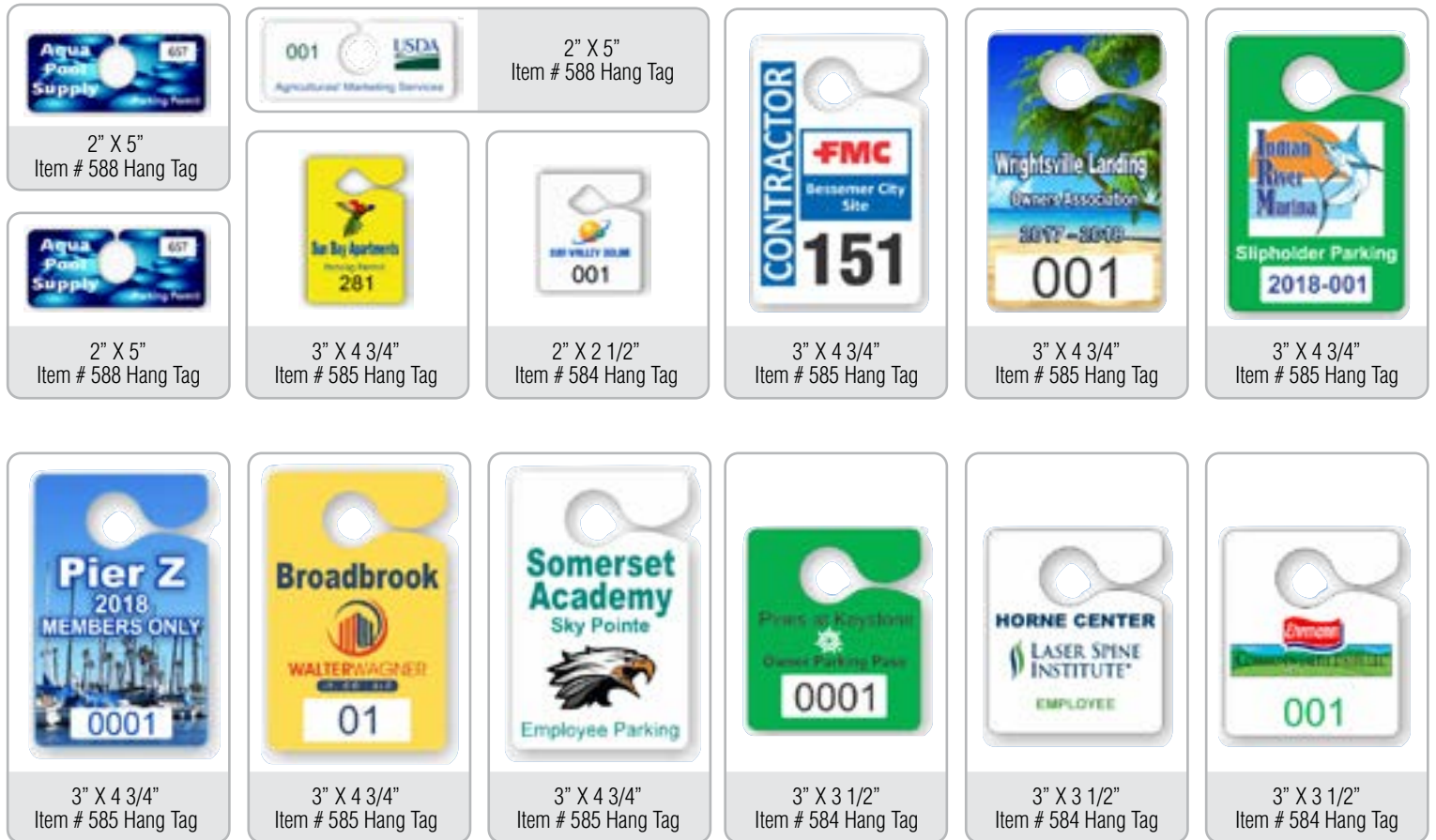

Unlimited Number of Colors

Standard Sizes for our Parking Hang Tags

Custom Sizes are also available

Our Parking Hang Tags are printed on White 35 point plastic, that is Water and Weather Proof with UV Lamination for added protection. Affordable, Durable and Reusable. Helps organize and secure Business, High Schools & Apartment parking lots. WE also carry a Low Cost Card Stock Permit that can be used for temporary and one time events.

- **FREE Shipping in the 48 Contiguous States!**
- **No Charge for Numbering for added Security!**
- **No Charge for Laminate for extra Protection!**
- **No Charge for Unlimited number of Colors!**
- **No Charge for School Mascots or Co. Logos!**
- **FREE Layout for a Professional Look!**

Call to Order **516-825-0727**
 Or Visit Us On-Line
Parkingproshop.com
 Bulk Pricing Available



Graphic Reflective Delineator



Single

\$70.99

Double Sided

\$94.99

Includes:

- 8"x36" Graphics
- Reflective Arrows and Lettering
- 20lb Base
- 12lb Base (option)
- 42" Total Height
- 100% Recycled Rubber Base
- Arrow Direction: Custom Arrow Direction Available

★ FREE CUSTOM DESIGN UPON REQUEST



GDR001



GDR002



GDR003



GDR004

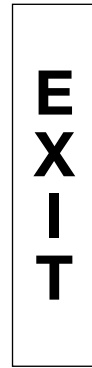

GDR005



GDR006



GDR007



GDR008



GDR009



GDR010



GDR011



GDR012



GDR013



GDR014

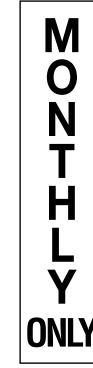

GDR015



GDR016

Intersection Signs



S3030R11(H)A
S3636R11(H)A
S4848R11(H)A



S3030R12(H)A
S3636R12(H)A
S4848R12(H)A



S3030R51(H)A
S3636R51(H)A



S3018R51A(H)A
S3634R51A(H)A



S1806R13P(H)A

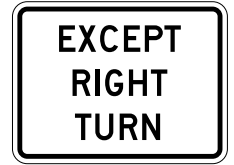

S2418R110P(H)A



S2412W44APL(H)A



S2412W44APR(H)A



S2412W44P(H)A



S2412W44BPL(H)A

Speed Limit Signs



S1824R2105(H)A
S2430R2105(H)A



S1824R2110(H)A
S2430R2110(H)A



S1824R2115(H)A
S2430R2115(H)A



S1824R2120(H)A
S2430R2120(H)A



S1824R2125(H)A
S2430R2125(H)A



S1824R2130(H)A
S2430R2130(H)A

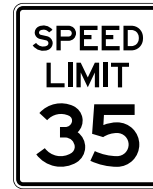

S1824R2135(H)A
S2430R2135(H)A



S1824R2140(H)A
S2430R2140(H)A



S2430R2145(H)A
S2036R2145(H)A



S2430R2150(H)A
S3036R2145(H)A



S2430R2155(H)A
S3036R2155(H)A

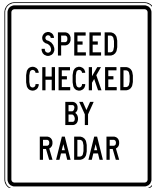

S1824R25D(H)A
S2430R25D(H)A

Call to Order **516-825-0727**
Or Visit Us On-Line
Parkingproshop.com
Bulk Pricing Available



Disabled Parking Signs State Specification



A(E)R781218S



S1218R78VA(E)A



S1218R78D(E)A



S1218R7500(E)A



(North Carolina)
SNC1226R78(E)A



(New York)
SNY1218R78(E)A



(Texas)
STX1224R78VA(E)A



(Florida)
SFL1218R75(E)A



(South Florida)
SFLS1218R75(E)A



S1218R7504(E)A



S1218R7502(E)A



S1218R7502N(E)A



S1218R75HPO(E)A



(North Carolina)
SNC1209R75(E)A



(Pennsylvania)
SPA1218R78F(E)A



(Texas)
STX1209R75(E)A



(Georgia)
SGA1218R75(E)A



(New Jersey)
SNJ1012R78250(E)A



S1206R78PB(E)A



S1206R78PG(E)A



S1212D96(E)
AS1818D96(E)A



S1206R78FG250(E)A



S1206R78FG350(E)A



S1206R78FB250(E)A

No Parking Signs



S1218R83A(E)
AS1824R83A(E)A



S1218R83AD(E)A



S1218R83AL(E)A



S1218R83AR(E)A



S1218R7200(E)A



S1218R76(E)A



S1218R76D(E)A



S1218R7100(E)A



S1218R71(E)A



S1218R71D(E)A



S1218R71L(E)A



S1218R71R(E)A



S1218R713(E)A



S1218R711(E)A



S1218R7232(E)A



S1218R712(E)A



S1218R712D(E)A



S1218R712L(E)A



S1218R712R(E)A



S1218R7216(E)A



S1218R7217(E)A



S1218R7228(E)A



S1218R7221(E)A



S1218R7224(E)A



S1218R7225(E)A



S1218R7236(E)A



S1218R7235(E)A



S1218R7215(E)A



S1218R7227(E)A



S1218R7213(E)A



S1218R7222(E)A



S1218R74M(E)A



S1218R7212(E)A



S1218R7230(E)A



S1218R7220(E)A



S1218R7229(E)A



S1212R83(E)A
S2424R83(E)A

Permissive Parking Signs



Private Parking Signs

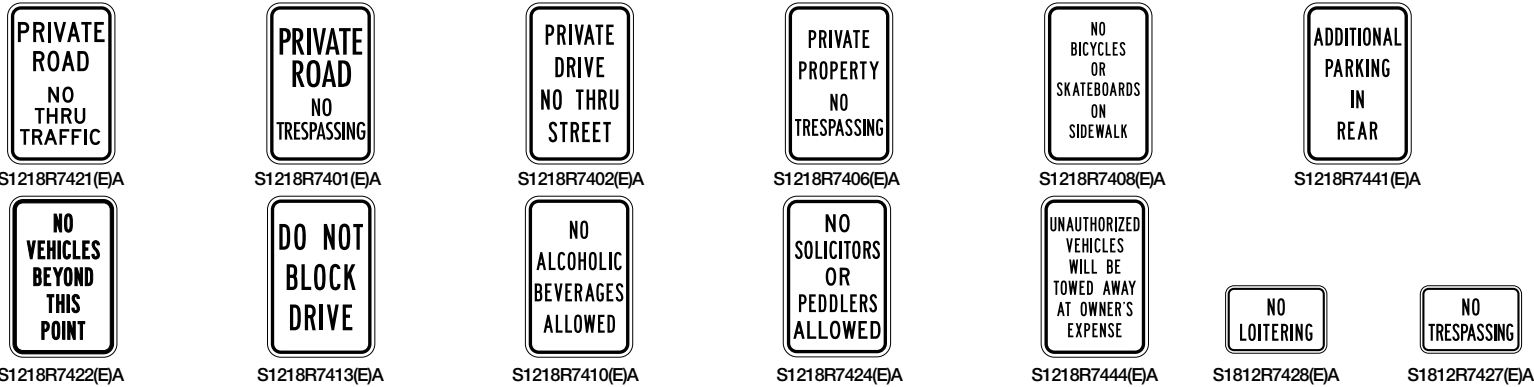

Parking Lot Signs

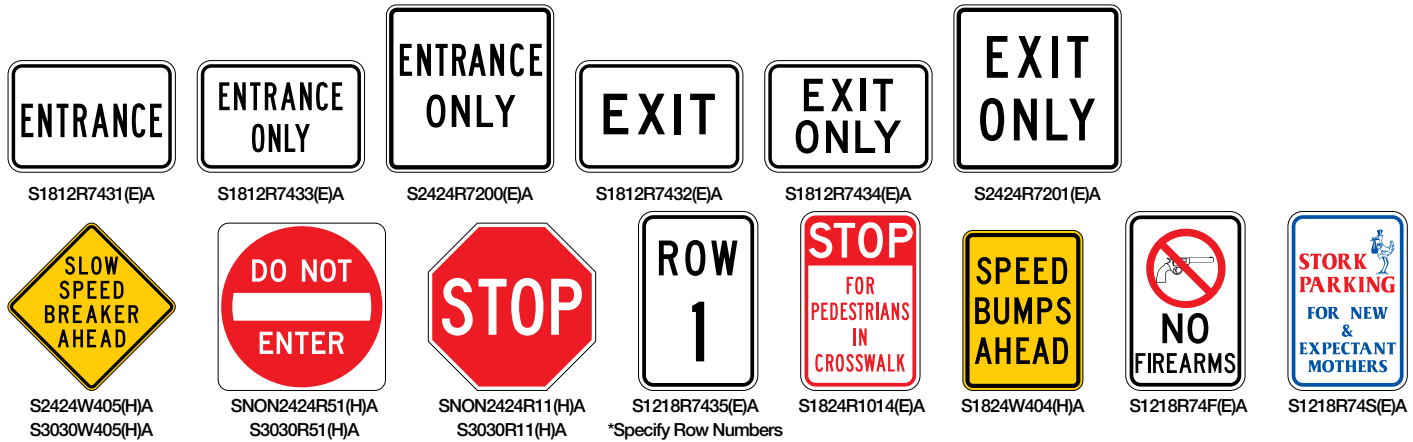

Road Closed & Weight Limit Signs



Call to Order **516-825-0727**
 Or Visit Us On-Line
Parkingproshop.com
 Bulk Pricing Available



Restrictive Traffic Prohibition Signs



No Right Turn
S2424R31(H)A



No Left Turn
S2424R32(H)A



No U-Turn
S2424R34(H)A



No Trucks
S2424R52(H)A



No Bicycles
S2424R56(H)A



S2424R33(H)A



S2424R53(H)A



S2418R31P(H)A



S2418R32P(H)A



S2418R34P(H)A



S2418R52P(H)A



S2418R56P(H)A



S2418R141(H)A

Pedestrian Signs



S3636R15L(H)A



S3636R15R(H)A

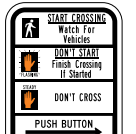

S0912R103B(R)(H)A

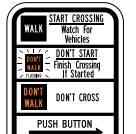

S0912R103C(R)(H)A



S0912R103D(R)(H)A

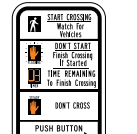

S0915R103E(R)(H)A



S1818R94(H)A
S2424R94(H)A



S1818R93(H)A
S2424R93(H)A



S0912R102(H)A



S0912R103(R)(H)A



S0915R103A(L)(H)A



S0915R104A(R)(H)A



S0912R104(L)(H)A



S1236R16A(H)DAG



S1236R16(H)DAG

Intersection and Center Lane Control Signs

Passing and Guidance Signs



Mandatory Left Turn
S3036R35L(H)A



Mandatory Straight
S3036R35A(H)A



Mandatory Right Turn
S3036R35R(H)A



Optional Movement Left
S3036R36L(H)A



Optional Movement Right
S3036R36R(H)A



Two Way Left Turn Overhead Mounted
S3036R39A(H)A



Two Way Left Turn Post Mounted
S2436R39B(H)A



Double Turn Right
S3030R38R(H)A



S3030R37L(H)A



S3030R37R(H)A



S3030R38L(H)A

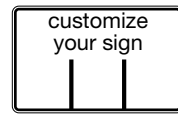
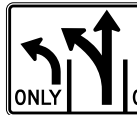

S1824R41(H)A
S2430R41(H)A



S1824R42(H)A
S2430R42(H)A



S2430R107(H)A



S1824R62A(H)A



Keep Left
S1824R48(H)A
S2430R48(H)A



Keep Left
S1824R48(H)A
S2430R48(H)A



Keep Left
S1824R47(H)A
S2430R47(H)A



Keep Left
S1824R47(H)A
S2430R47(H)A



S1824R109A(H)A



S1824R109(H)A



S1824R62L(H)A
S2430R62L(H)A



S1824R62R(H)A
S2430R62R(H)A



S3612R61L(H)A



S3612R61R(H)A

In-Street Pedestrian Crosswalk Signage



PART#	LEGEND
RPOFPIPX50WHTSS603	YIELD to Ped - Double Faced
RPOFPIPX50WHTSS602	YIELD to Ped - Single Faced
RPOFPIPX50WHTSS605	STOP for Ped - Double Faced
RPOFPIPX50WHTSS604	STOP for Ped - Single Faced
Choose Sign from above to use with the Yeti Base	
RPOFZPXTUBEBASEYETI	"The Yeti" 40# Portable Base
RPOFZPXTUBEBASE800QR	Quick Release Pin for 1.75" X-Tube Post



PART#	LEGEND
RPOFPIPG342FLGF613	YIELD to Ped - Double Faced
RPOFPIPG342FLGF612	YIELD to Ped - Single Faced
RPOFPIPG342FLGF615	STOP for Ped - Double Faced
RPOFPIPG342FLGF614	STOP for Ped - Single Faced
Choose Sign from above to use with the Banana Base or Fixed Base	
RPOFZPBASEBANANA	35# Portable Banana Base
RPOFZPFG300BAFYG	Fixed Base
RHSMSCA3840	Asphalt Anchor Bolt
RHSMSCA3825	Concrete Anchor Bolt
RPOFZPFG300XPINS	Post Pins (Box of 50)

In-Street Pedestrian Crosswalk Signage



Quick Release Mounting Style Post w/Sign

PART#	LEGEND	
RPOFPIPDSTDQ	STOP for Ped	Double Faced
RPOFPIPDYDDQ	YIELD to Ped	Double Faced
RPOFPIPDYDSQ	YIELD to Ped	Single Faced
RPOFPIPSSTDQ	(SCHOOL) STOP for Ped	Double Faced
RPOFPIPSYDDQ	(SCHOOL) YIELD to Ped	Double Faced
RPOFPIPSYDSQ	(SCHOOL) YIELD to Ped	Single Faced

Choose Sign from above to use with a Base below

PART#	LEGEND
RPOFZIQRFBASEBK	Quick Release Base - Surface Mount
RPOFZIRBHPQR	Recessed Base - High Profile for Asphalt
RPOFZIRBLPQR	Recessed Base - Low Profile for Concrete
RPOFZIQRPBASE	Portable One Base - 100% Recycled Rubber
RPOFZIQRPIN	Quick Release Replacement Pin

Fixed Mounting Style Post w/Sign

PART#	LEGEND	
RPOFPIPDSTDF	STOP for Ped	Double Faced
RPOFPIPDSTSF	STOP for Ped	Single Faced
RPOFPIPDYDDF	YIELD to Ped	Double Faced
RPOFPIPDYDSF	YIELD to Ped	Single Faced
RPOFPIPSSTDF	(SCHOOL) STOP for Ped	Double Faced
RPOFPIPSYDDF	(SCHOOL) YIELD to Ped	Double Faced

Choose Sign from above to use with a Base below

PART#	LEGEND
RPOFZISMFBK	Fixed Base - Surface Mount
RHSMLS12	Anchor Kit with 4 lag screws (installs 1 base)

Ped-in-a-Bag®

PART#	LEGEND	
RPOFPIPSZSTDP	(SCHOOL) STOP for Ped	Double Faced
RPOFPIPSZYDDP	(SCHOOL) Yield to Ped	Double Faced
RPOFZIQRPBASEL	Lightweight base for ped-in-a-bag (base and top sold separately)	

Portable School Zone Signage



Call to Order **516-825-0727**
 Or Visit Us On-Line
Parkingproshop.com
 Bulk Pricing Available



Facility Signs

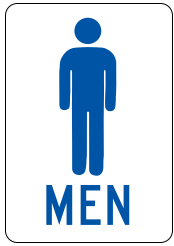

ISS0710A230



ISS0710A231



ISS0710A232



ISS0710A233



ISS0710A234



ISS0710A235



ISS0710A220



ISS1014A225



ISS1014A226



ISS1014A227



ISS1014A210



ISS1014A211



ISS1014A212



ISS1014A204



ISS1014A205



ISS1014A206



ISS1014A207



ISS1014A200



ISS1014A201



ISS1014A202



ISS1014A203



S1218PC236(H)A



S1218PC236(H)A



S1218PC236(H)A



ISS1420AP401

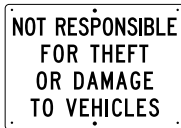

ISS1420AP402



ISS1420AP403

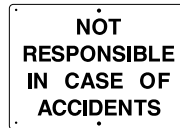

ISS1420AP404



ISS1420AP405



ISS1420AP406



ISS1420AP407



ISS1420AP408



ISS1420AP409



ISS1420AP410



ISS1420AP411



ISS1420AP412



ISS1420AP413



ISS1420AP414



ISS1420AP415



ISS1420AP416



ISS1420AP417



ISS1420AP418



ISS1420AP419



ISS1420AP420

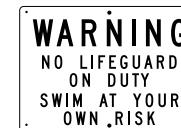

ISS1420AP421

Tip and Roll Snap Frame Stanchion



Just Tip & Roll Portable Sign System

- 120lb Base
- Accommodates 28" x44" or 24"x36" Sign
- Engineer Grade Reflective Frame
- Heavy Duty Snap Frame 1.5" flaps
- Add sign, Starting from

\$39.99



White Blue Red Orange Green

TRSFS2436W
TRSFS2844W

TRSFS2436B
TRSFS2844B

TRSFS2436R
TRSFS2844R

TRSFS2436O
TRSFS2844O

TRSFS2436G
TRSFS2844G

Call to Order **516-825-0727**
Or Visit Us On-Line
Parkingproshop.com
Bulk Pricing Available



Sign Stanchion



- »» 36"x60" Illuminated sign stanchion
- »» Outdoor SEG fabric display (fire rated) By Berger Samba Germany
- »» Anodized aluminum extrusion frame
- »» High output LED lights on the inside (IP68)

OVERHANGING LED LIGHT FIXTURE



- »» 12"x96" Illuminated overhanging display
- »» Outdoor SEG fabric display (fire rated) By Berger Samba Germany
- »» Anodized aluminum extrusion frame
- »» High output LED lights on the inside and outside (outdoor) (IP68)

Call to Order **516-825-0727**
Or Visit Us On-Line
Parkingproshop.com
Bulk Pricing Available



Snap Frames, A Frames, Wind Masters



SFB



SFWB

28x44 Snap Frame

- Black
- Frame Only
- W/ Back Board

\$78.00

\$114.00



PLF-SCD4827BK
PLF-SCD4827W

Signicade Deluxe

- Colors:
- 24" x36"

\$130.00



PLF-SC4525W PLF-SC4525Y
PLF-SC4525O PLF-SC4525BK
PLF-SC4525BL

Signicade

- Colors:
- 24" x36"

\$109.00

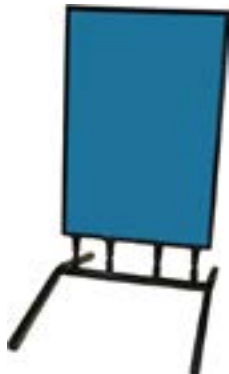

STF-FL3626

Flex Frame

- Black, Double sided
- 24" x36"

\$210.00



PLF-WS3624GY

Plasticade Windsign II

- Water/Sand Base
- 24" x36"
- Double Sided

\$260.00



PLF-WS4428GY



Plasticade Windsign Deluxe



- Water/Sand Base
- 28" x44"
- Double Sided

\$369.99



Windmaster



- Classic Tool-less legs**
- Material: Aluminum Frame, White Fluted Polypropylene Back
 - Finishes: Black, Satin Silver
 - Colors:  or 

Available in 41x55 **515.00**
 or  1015





- Classic rolling base**
- Material: Aluminum Frame, White Fluted Polypropylene Back
 - Finishes: Black, Satin Silver
 - Colors:  or 
 - Base Weight When Filled with Water: 87 lb.



- WindMaster rolling base**
- Frame Material: Black Aluminum Frame, White Fluted Polypropylene Back
 - Frame Finish: Black with Black Molded Corners
 - Base: Black Molded Polyethylene
 - Colors: 



- WindMaster Rolling Base**
- Material: Aluminum Frame, White Fluted Polypropylene Back
 - Base Material: Black Molded Polyethylene
 - Finishes: Black with Black Corners, Satin Silver with Black Corners
 - Colors:  or 



- WindMaster Rolling Base**
- Material: Aluminum Frame, White Fluted Polypropylene Back
 - Base Material: Black Molded Polyethylene
 - Finishes: Satin Silver with Black Corners
 - Colors: 



- WindMaster Slide-In Rolling Base**
- Material: Aluminum Frame, White Fluted Polypropylene Back
 - Base Material: Black Molded Polyethylene Base
 - Finishes: Black
 - Colors: 

Call to Order **516-825-0727**
 Or Visit Us On-Line
Parkingproshop.com
 Bulk Pricing Available



Letrapole



Left and Right Side Mount



Left Side Mount



Left and Right Side Mount



Right Side Mount



Downtown



Universities



Retail

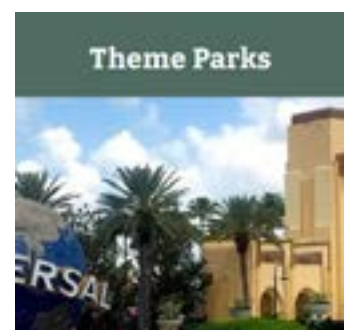

Theme Parks

Is your city a true destination? How is that communicated? As you welcome visitors, let them know what's special about this place. Don't forget to advertise upcoming events

Show your school spirit. Honor your rich history and tradition. Showcase student artwork. Let people know about upcoming events. Welcome in new students.

Co-brand with suppliers. Introduce new products. Thank your customers. Be festive around the holidays. Point people in the right direction.

Feature new attractions. Partner with food and beverage brands. Announce upcoming events like "Halloween". Use as a park directory.



Auto Dealerships



Sports Complex

Advertise special financing. Introduce new models. Show off your awards. Brag about your service. Be festive and/or patriotic.

Showcase your post season success. Feature your past and present super stars. Announce upcoming events. Co-brand with food and beverage partners.

The most creative, cost effective, simplest and durable "automated" pole banner system available on the market.

Available in 3 sizes

98x36

55x30

36x24

Parking Warning Systems



CCV4807G-Kit

\$2,450.00

Car Coming Warning Post

Wall mounted
2 Sides >180° view
Size: 40" H x 8"

Includes:

Timer Control Board
Voice Alert Board
Power Supply
Speaker
Vehicle Motion Detector



CR1806KIT

\$1,600.00

Car Alley Exit Sign

Ground mounted
4 Sides 360° view
Size: 48" H x 6" x 6"

Includes:

Timer Control Board
Voice Alert Board
Power Supply
Speaker
Vehicle Motion Detector



CC4008V-Kit

\$2,600.00

CAR Alley Exit Warning Sign

Wall mounted
3 Sides >180° view
Size: 18" H x 6" x 6"

Includes:

Timer Control Board
Voice Alert Board
Power Supply
Speaker
Vehicle Motion Detector



\$70.99

Entry Alert System, 22ft

Includes:

- NIR retro-reflective sensor.
- Reflector.
- Speaker.
- 9VDC 200mA power adapter. 6ft cable

Pedestrian Alert Safety Sign (PASS) manufactures systems that alert pedestrians of vehicles exiting your parking garages, parking lots, driveways/alleyways and loading docks using audio voice & flashing light signals.

FREE SHIPPING

Call to Order **516-825-0727**
Or Visit Us On-Line
Parkingproshop.com
Bulk Pricing Available



Wheel Dolly



GoJak® G6313

Weight:
47 lbs

Dimensions:
25.5 × 26.125 × 8.125 in

Foot Pedal Orientation:
Standard (Right), Left

Max Rated Load (Lbs):
1575

Max Tire Tread (In):
13

Warranty:
Warranted to be free of defects in material or workmanship under normal use for seven years from the date of sale to user

\$329.00



GoJak Storage Cart - G567R

Weight:
18 lbs

Max Rated Load (Lbs):
250

\$119.00

Convex Mirrors

DomeVex Mirrors



4" DEEP
16"

5" DEEP
24"

5" DEEP
32"

Indoor		
SCVI - 16Z - 4DP	16"	\$69.70
SCVI - 24Z - 5DP	24"	\$115.00
SCVI - 32T - 7DP	32"	\$156.00

Outdoor		
SCVO - 16Z - 4DP-PB	16"	\$97.00
SCVO - 24Z - 4DP-PB	24"	\$172.00
TCVO - 32T - 7DP-PB	32"	\$219.00

Safety Border Caution Mirrors with Stripes



Indoor			
SCVI - 18Z - SB	18"	Z	\$68.00
SCVI - 26T - SB	26"	Telescoping	\$111.00
SCVI - 30T - SB	30"	Telescoping	\$130.00

Outdoor			
DCVO - 18T - SB	18"	(2) Telescoping	\$93.00
TCVO - 26T - SB	26"	(3) Telescoping	\$162.00
TCVO - 30T - SB	30"	(3) Telescoping	\$188.00

Convex Mirrors



Indoor			
SCVI - 12Z	12"	Z	\$33.75
SCVI - 18Z	18"	Z	\$45.90
SCVI - 26T	26"	Telescoping	\$82.00
SCVI - 30Z	30"	Telescoping	\$106.50
SCVI - 36T	36"	Telescoping	\$151.00
DCVI - 48T	48"	Telescoping	\$280.00

Outdoor			
SCVO - 18Z - PB	18"	(2)Telescoping	\$79.00
SCVO- 26T - PB	26"	(3)Telescoping	\$135.00
SCVO - 30T - PB	30"	(3)Telescoping	\$162.00
SCVO - 36Z - PB	36"	(3)Telescoping	\$216.00
DCVO - 48T - PB	48"	(3)Telescoping	\$408.00

Inspection Mirrors



Indoor	
DM-8C 8" Convex w/handle	\$74.00
DM-8F 8" Flat w/handle	\$74.00
DM-8LC 8" Convex w/handle+light	\$117.00
DM-8LF 8" Flat w/handle+light	\$117.00
DM-12C 12" Convex w/handle	\$96.00
DM-12F 12" Flat w/handle	\$96.00

Indoor	
DM-12LC 12" Cvx w/handle+light	\$134.00
DM-12LF 12" Flat w/handle+light	\$134.00
DM-12WC 12"Cvx W/wheels	\$168.00
DM-12WF 12"Flat W/wheels	\$168.00
DM-12WLC 12"Cvx W/wheels+light	\$206.00
DM-12WLF 12"Flat W/wheels+light	\$206.00

Call to Order **516-825-0727**
 Or Visit Us On-Line
Parkingproshop.com
 Bulk Pricing Available



Bicycle Racks



model
BR-P10-BK-CH



model
BR-P10-BK-CD

Eco-Friendly Bike Racks provide users with a high level of security to lock up their bikes and other recreational toys. Made in America of 100% post-consumer recycled plastic, the six posts fit perfectly where space is limited. Promote a healthy lifestyle in your school, community, and public spaces by providing a secure rack to park bikes.

MODEL NUMBER	INSERT POSITIONS	OVERALL SIZE (W x L x H)	COLORS	WEIGHT (POUND)
BR-P6-BK-BK	6	42" x 48 ⁷ / ₁₆ " x 31"	BLACK/BLACK	125
BR-P6-BK-CD	6	42" x 48 ⁷ / ₁₆ " x 31"	BLACK/CEDAR	125
BR-P6-BK-CH	6	42" x 48 ⁷ / ₁₆ " x 31"	BLACK/CHARCOAL	125
BR-P10-BK-BK	10	42" x 72" x 31"	BLACK/BLACK	187
BR-P10-BK-CD	10	42" x 72" x 31"	BLACK/CEDAR	187
BR-P10-BK-CH	10	42" x 72" x 31"	BLACK/CHARCOAL	187
BR-ABK	(4) "L" BRACKETS & SCREWS ground anchors not included			1



model BR-L3-BK

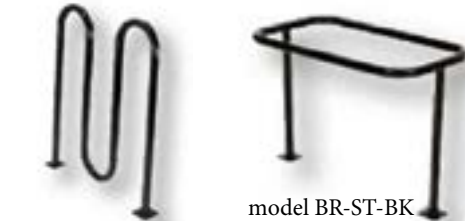

model BR-L2-BK



model BR-ST-BK



model BR-M3S-BK



model BR-M3D-BK



model BR-M3S-W-BK

Our Bicycle Racks make it easy to store bikes where space is at a premium. Welded steel units feature eight (8) mounting flanges with pre-drilled 7/16" holes for easy mounting with the exception of model numbers BR-GL-BK and BR-GL-G which has two (2) 3/4" mounting holes. Hardware is sold separately. Racks are shipped fully-assembled and ready to use. Available in powder coat black or galvanized finish. Other powder coat finishes are available. Please contact factory.

MODEL NUMBER	BIKE CAPACITY	MOUNTIN STYLE	OVERALL SIZE (W x L x H)	WEIGHT (POUND)
BR-L2-BK	5	GROUND	4" x 31" x 36"	25
BR-L3-BK	7	GROUND	4" x 49" x 36"	36
BR-ST-BK	2	GROUND	20" x 38 ⁵ / ₁₆ " x 26 ¹ / ₂ "	31
BR-M3S-BK	3	GROUND	13 ⁹ / ₁₆ " x 45 ⁷ / ₈ " x 14 ⁹ / ₁₆ "	31
BR-L3D-BK	6	GROUND	27 ³ / ₁₆ " x 42" x 14 ⁹ / ₁₆ "	53
BR-3S-W-BK	3	WALL	12 ⁷ / ₈ " x 40 ³ / ₈ " x 4 ¹ / ₁₆ "	23
BR-GL-BK	4	GROUND	5 ¹ / ₁₆ " x 12 ³ / ₄ " x 22 ¹ / ₂ "	22
BR-L2-GAL	5	GROUND	4" x 31" x 36"	25
BR-L3-GAL	7	GROUND	4" x 49" x 36"	36
BR-ST-GAL	2	GROUND	20" x 38 ⁵ / ₁₆ " x 26 ¹ / ₂ "	31
BR-M3S-GAL	3	GROUND	13 ⁹ / ₁₆ " x 45 ⁷ / ₈ " x 14 ⁹ / ₁₆ "	31
BR-M3D-GAL	6	GROUND	27 ³ / ₁₆ " x 42" x 14 ⁹ / ₁₆ "	53
BR-M3S-W-GAL	3	WALL	12 ⁷ / ₈ " x 40 ³ / ₈ " x 4 ¹ / ₁₆ "	23
BR-GL-G	4	GROUND	5 ¹ / ₁₆ " x 12 ³ / ₄ " x 22 ¹ / ₂ "	22
AS-383	3/8" x 3"L CONCRETE ANCHOR (Sold Each) for 7/16" holes 5/8" x			1
AS-584	4"L CONCRETE ANCHOR (Sold Each) for 3/4" holes			1

SPECIAL POWDER COAT FINISH OPTIONS

ERGO BLUE	SODA RED
SKY BLUE	BUBBLE GUM
SILVER LINING	CITRUS ORANGE
MACHINE GRAY	YELLOW
BATTLESHIP GRAY	HUNTER GREEN
BROWN	TRACTOR GREEN
KHAKI TAN	SNOWY WHITE
SANDY BEIGE	LIQUID ENAMEL PRIMER



Model 301 Bicycle Locker



Single

Model 302 Bicycle Locker



Double

- One piece bicycle storage locker
- 2 bicycle capacity
- Tan or gray available
- 2 locking options available
- No assembly required
- Separate security and access to each bike with 2 doors
- Highly resistant to impact stains and will not corrode

Product Details:

- Product Name: Bike-Shell Model 302 Bicycle Locker
- Dimensions: 49”H x 40”W x 74 ½ “L
- Weight: 280 lbs
- Material: Fiberglass and polyester resin
- Hardware: Zinc plated door hinge
- Installation Accessories: Four expansion anchors included
- Locking Options: Pop out “T” Handle with 3 master keys or Padlock/U-Locking handle (padlock not included)
- Colors: Gray or tan
- Storage Capacity: 2 door/ 2 bicycles

CALL FOR PRICING

SKU: 301, 302

Call to Order **516-825-0727**
Or Visit Us On-Line
Parkingproshop.com
Bulk Pricing Available



Speed bumps

Recycled Plastic Speed Bump

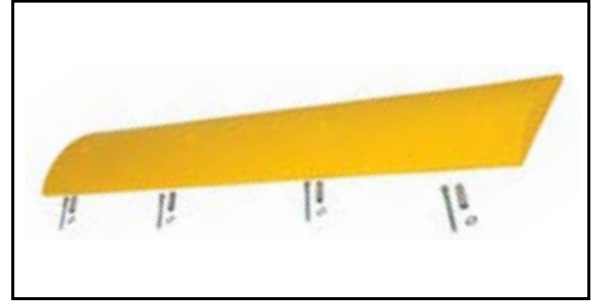

Recycled Plastic Speed Bumps - 4 Ft - * Specify hardware selection: L = Lag Screws; S = Steel Spikes

MODEL WITH HARDWARE	MODEL WITHOUT HARDWARE	DESCRIPTION	LENGTH	HEIGHT	WIDTH	WEIGHT	COLOR	PRICE	PRICE W/ HARDWARE	MIN ORDER
SB4S*	SB4S	Standard 4 ft. Speed Bump	48 in	2 in	10 in	22 lb	Yellow	\$132.00	\$142.00	N/A
SB4D*	SB4D	Deluxe 4 ft. Speed Bump	48 in	2.25 in	12 in	28 lb	Yellow	\$138.00	\$148.00	N/A

Recycled Plastic Speed Bumps - 6 ft - * Specify hardware selection: L = Lag Screws; S = Steel Spikes

MODEL WITH HARDWARE	MODEL WITHOUT HARDWARE	DESCRIPTION	LENGTH	HEIGHT	WIDTH	WEIGHT	COLOR	PRICE	PRICE W/ HARDWARE	MIN ORDER
SB6S*	SB6S	Standard 6 ft. Speed Bump	72 in	2 in	10 in	25 lb	Yellow	\$168.00	\$198.00	N/A
SB6D*	SB6D	Deluxe 4 ft. Speed Bump	72 in	2.25 in	12 in	41 lb	Yellow	\$210.00	\$234.00	N/A

Recycled Plastic Speed Bumps - 9 ft - * Specify hardware selection: L = Lag Screws; S = Steel Spikes

MODEL WITH HARDWARE	MODEL WITHOUT HARDWARE	DESCRIPTION	LENGTH	HEIGHT	WIDTH	WEIGHT	COLOR	PRICE	PRICE W/ HARDWARE	MIN ORDER
SB9S*	SB9S	Standard 9 ft. Speed Bump	108 in	2 in	10 in	50 lb	Yellow	\$312.00	\$336.00	N/A

Alley Bumps

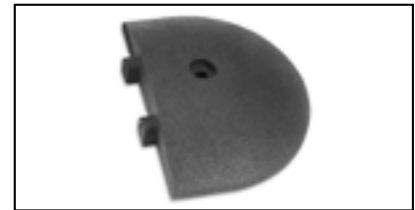

MODEL	SIZE	WEIGHT	BOLTS NEEDED	PRICE	MIN ORDER
26300	6 ft. L x 12 in. W x 3 in. H	76 lbs	4	\$204.00	N/A
24300	4 ft. L x 12 in. W x 3 in. H	51 lbs	3	\$156.00	N/A
26998 (end cap)	6 ft. L x 12 in. W x 3 in. H	8 lbs	1	\$24.00	N/A

Speed humps and wheel stops

Easy Rider® Speed Bumps



MODEL	SIZE	WEIGHT	BOLTS NEEDED	PRICE	MIN ORDER
26111	6 ft. L x 12 in. W x 2.25 in. H	51 lbs	4	\$150.00	N/A
24111	4 ft. L x 12 in. W x 2.25 in. H	32 lbs	3	\$114.00	N/A
26999 (end cap)	6 ft. L x 12 in. W x 2.25 in. H	5.5 lbs	1	\$25.00	N/A
VR-206-8-M	6 ft. L x 12 in. W x 2 in. H	55 lbs	4	\$98.00	N/A
VR-206-8-E	6 ft. L x 12 in. W x 2 in. H	51 lbs	1	\$26.00	N/A

Safety Rider® V Mini Humps

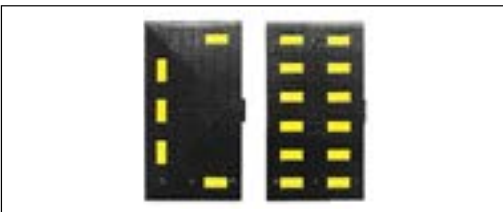

MODEL	SIZE	WEIGHT	BOLTS NEEDED	PRICE	MIN ORDER
23500V	35" x 19.5" x 2.1"	34 lbs	4	\$78.00	N/A
23501V	Male 35" x 19.5" x 2.1"	32 lbs	3	\$60.00	N/A
32502V	Female 35" x 19.5" x 2.1"	32 lbs	1	\$60.00	N/A

*** Includes Hardware Installation**

Park-It® Recycled Rubber Parking Stop



MODEL	DESCRIPTION	SIZE	WEIGHT	SPIKES NEEDED	PRICE	Hardware		MIN ORDER
						Spike	Cap+Bolt	
16101Y	6 ft. Park-It/Yellow Tape	6 ft. L x 6 in. W x 4 in. H	34 lbs	4	\$46.00	\$4.20	\$6.60	N/A
16101W	6 ft. Park-It/White Tape	6 ft. L x 6 in. W x 4 in. H	34 lbs	4	\$46.00	\$4.20	\$6.60	N/A
14101Y	4 ft. Park-It/Yellow Tape	4 ft. L x 6 in. W x 4 in. H	23 lbs	3	\$32.00	\$4.20	\$6.60	N/A
14101W	4 ft. Park-It/White Tape	4 ft. L x 6 in. W x 4 in. H	23 lbs	3	\$32.00	\$4.20	\$6.60	N/A
13101Y	3 ft. Park-It/Yellow Tape	3 ft. L x 6 in. W x 4 in. H	17 lbs	2	\$24.00	\$4.20	\$6.60	N/A
13101W	3 ft. Park-It/White Tape	3 ft. L x 6 in. W x 4 in. H	17 lbs	2	\$24.00	\$4.20	\$6.60	N/A
16201B	6 ft. ADA Park-It/Blue Car Stop	6 ft. L x 6 in. W x 4 in. H	34 lbs	4	\$72.00	\$4.20	\$6.60	N/A
14201B	4 ft. ADA Park-It/Blue Car Stop	4 ft. L x 6 in. W x 4 in. H	23 lbs	3	\$56.00	\$4.20	\$6.60	N/A
13201B	3 ft. ADA Park-It/Blue Car Stop	3 ft. L x 6 in. W x 4 in. H	17 lbs.	2	\$34.00	\$4.20	\$6.60	N/A

Call to Order **516-825-0727**
Or Visit Us On-Line
Parkingproshop.com
Bulk Pricing Available



Protective Parking Stops & Speed Bump-Cable Protectors

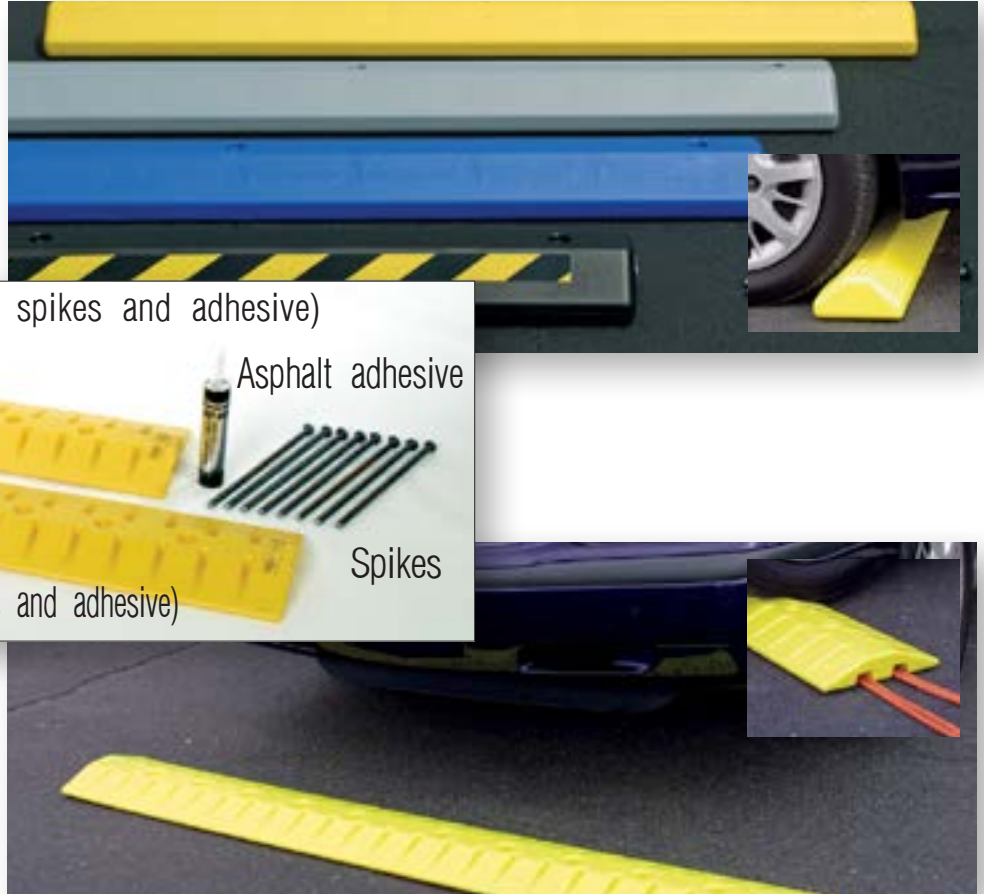

6 ft. Speed Bump (includes 6 spikes and adhesive)

Asphalt adhesive

Spikes

9 ft. Speed Bump (includes 8 spikes and adhesive)

1790Y	Parking Stop-Yellow Polyethylene	15 lb	\$78.00
1790B	Parking Stop-Blue Polyethylene	15 lb	\$78.00
1790BLK	Parking Stop-Black Polyethylene	15 lb	\$78.00
1790G	Parking Stop-Gray Polyethylene	15 lb	\$78.00
1792	Speed Bump/Cable Crossing Unit, 6 ft.	20 lb	\$124.00
1793	Speed Bump/Cable Crossing Kit, 9 ft.	25 lb	\$156.00

12x18 & 18x24 Speed Humps and Bumps Caution Signs

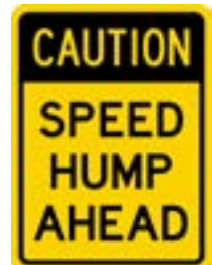

Corner and Wall Cushions



Wall Cushions

\$21.00

- 48" x 12" x 1.5"



Corner Cushions

\$22.00

- 48" x 5" x 5"

Volume discount available



Spray adhesive

\$14.00

- 1 can 12oz



Cg 900

CORNER GUARDS
Heavy Duty
industrial
strength rubber

\$24.99

- Weight: 5.5lbs
- Height: 1"
- Length: 36"
- Width: 4"



Cg 800

CORNER GUARDS
Medium Duty industri-
al strength rubber

\$21.99

- Weight: 4.37lbs
- Height: 1/2"
- Length: 31 3/8"
- Width: 3 1/2"



WP 1000

WALL PROTECTOR
Heavy Duty capa-
ble of withstanding
substantial impact

\$33.99

- Weight: 11lbs
- Height: 2 1/4"
- Length: 39 3/4"
- Width: 6"



WP-MD

WALL PROTECTOR
Medium Duty
with four reflective
yellow chevrons

\$21.99

- Weight: 6lbs
- Height: 1/2"
- Length: 31 1/2"
- Width: 8 3/4"

Call to Order **516-825-0727**
Or Visit Us On-Line
Parkingproshop.com
Bulk Pricing Available



Corner and Wall Cushions



ROLL

Column Protectors BumperWrap - Black/Yellow, 40 foot roll, 12" wide x 1/2" thick

- Padded protection for columns, light pole bases, beams and large obstacles
- Black/Yellow, 40 foot roll, 12" wide x 1/2" thick

Roll	40' Roll of Black/Yellow BumperWrap, 60 lbs.	\$358.00
------	--	----------



PS-Y-KIT

Park Sentry Column Protectors Yellow Square Kit (4 Corners, 4 planks, 2 straps)

- Standard kit perfectly fits a 24"x24" square column
- Easily modified to fit any sized square or rectangular industrial column
- Oil, chemical, water and flame resistant
- Available in Yellow or Black

PS-Y-KIT	7"x52" Bollard Cover (7.125" ID)	\$418.00
----------	----------------------------------	----------



PSR-045-Y-CTN

Park Sentry Round Plank - Yellow (3/carton)

- 1 carton fits up to a 24" diameter round column
- Can be installed in single or multiple layers
- Available in Yellow or Black
- Sold only in full cartons of three
- Straps sold separately

PSR-045-Y-CTN	Park Sentry Round Plank - Yellow (3/carton)	\$158.00
---------------	---	----------



PSS-4000-BR-SL

Park Sentry Strap 158" - Black Reflective - Strap Lock Buckle, Two straps/ set

- 158" long x 2" wide adjustable strap
- Black Reflective
- Vandal resistant

PSS-4000-BR-SL	Park Sentry Strap 158" - Black Reflective - Strap Lock Buckle, Two straps/ set	\$43.80
----------------	--	---------



CW-36, CW-48, CW-60, CW-72

Cushioned Column Wrap, Soft Padded Cover

- 44"x36" stock height, 44"x48" stock height, 44"x60" stock height, 44"x72" stock height
- Two 2" white or red reflective sewn bands
- Waterproof, fade resistant and mold/mildew proof

CW-36	44" Tall x 36" Wide Column Wrap	\$100
CW-48	44" Tall x 48" Wide Column Wrap	\$123
CW-60	44" Tall x 60" Wide Column Wrap	\$146
CW-72	44" Tall x 72" Wide Column Wrap	\$168



(108")
(72")
(50")

GG-50, GG-72, GG-108

Soft Padded Gate Arm Cover

- Fits 1"x4" standard gate arms.
- 2" white or red reflective sewn bands
- Waterproof, fade resistant and mold/mildew proof

GG-50	50" wide Gate Guard to fit standard 1"x4" gate arm stock	\$105
GG-72	72" wide Gate Guard to fit standard 1"x4" gate arm stock	\$117
GG-108	108" wide Gate Guard to fit standard 1"x4" gate arm stock	\$129



PS-B-KIT

Park Sentry Column Protectors Black Square Kit (4 Corners, 4 planks, 2 straps)

- Standard kit perfectly fits a 24"x24" square column
- Easily modified to fit any sized square or rectangular industrial column
- Oil, chemical, water and flame resistant
- Available in Yellow or Black

PS-B-KIT	Park Sentry Black Square Kit (4 Corners 4 planks, 2 straps)	\$330.00
----------	---	----------

Ceiling Leak Diverter



Durable, puncture resistant, and watertight EnGuard™ I PVC coated yellow fabric is designed to channel overhead pipe and ceiling leaks to containers or floor drains. Diverters help provide a fast and economical way to protect your personnel, equipment, and inventory. Simply connect to a standard garden hose to drain water safely away. Flow rate of 3.3 gal/min (12.5 L/min).

Model	Description	Material	Color	Width	height	Net Weight	Price
28300	CEILING LEAK DIVERTER	PVC coated fabric	Yellow	5 ft	5 ft	4 lb	\$78.00
28302	CEILING LEAK DIVERTER WITH MAGNETS	PVC coated fabric	Yellow	5 ft	5 ft	4 lb	\$222.00
28304	CEILING LEAK DIVERTER	PVC coated fabric	Yellow	7 ft	7 ft	7 lb	\$138.00
28306	CEILING LEAK DIVERTER WITH MAGNETS	PVC coated fabric	Yellow	7 ft	7 ft	7 lb	\$282.00
28308	CEILING LEAK DIVERTER	PVC coated fabric	Yellow	10 ft	10 ft	14 lb	\$270.00
28310	CEILING LEAK DIVERTER WITH MAGNETS	PVC coated fabric	Yellow	10 ft	10 ft	14 lb	\$426.00
28312	CEILING LEAK DIVERTER	PVC coated fabric	Yellow	12 ft	12 ft	20 lb	\$522.00
28314	CEILING LEAK DIVERTER WITH MAGNETS,	PVC coated fabric	Yellow	12 ft	12 ft	21 lb	\$762.00
28315	CEILING LEAK DIVERTER	PVC coated fabric	Yellow	15 ft	15 ft	31 lb	\$558.00
28318	CEILING LEAK DIVERTER	PVC coated fabric	Yellow	20 ft	20 ft	56 lb	\$642.00

Call to Order **516-825-0727**
 Or Visit Us On-Line
Parkingproshop.com
 Bulk Pricing Available



Clearance Bars



CB-4104	4.95"X104"	\$87.99
CB-4120	4.95"X120"	\$93.99
CB-7104	7.35"X104"	\$110.99
CB-7120	7.35"x120	\$112.99
CB-Logo	Lettering	\$21.00
HWK	Hardware	\$14.00

Bar Colors:



Reflective Tape:



- Wall thickness: .125" wall
- Material: Bar - HDPE/Screws - Steel
- Accessories: Screws to bolt sections together and reflective tape (2 pieces 10" apart at each end)"

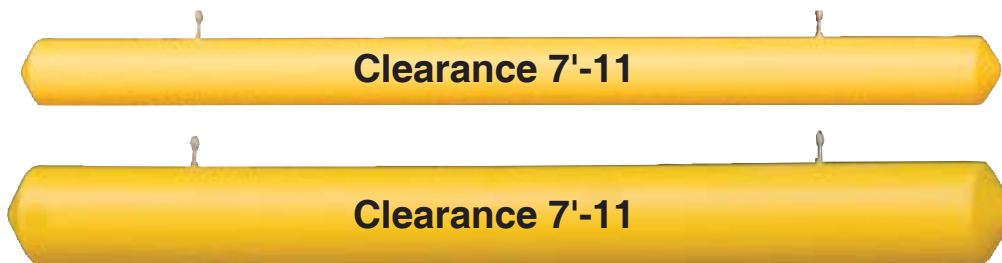

1780	5" x 76" Yellow Clearance Bar w/Eye Hooks	7.0 lb	\$164.00
1781	7" X 77" Yellow Clearance Bar w/Eye Hooks	9.0 lb	\$201.00
CB-Logo	Lettering		\$21.00
HWK	Hardware		\$14.00

Bollard Posts and Machine Guards

Bollard Post

Bollard Posts add protection to your facility and prevent damage. Posts feature a durable baked-on powder coat in safety yellow to provide high visibility. Each post is made of 1/4 in. (.63 cm.) thick (Schedule 40 or Schedule 10) steel mounted on 3/8 in. (.95 cm.) steel plates, pre-drilled (3/4 in./1.9 cm.) for easy installation. The black HDPE post caps are included and can be removed to fill posts with concrete for extra protection.

Machine Guards

Our machine guards provide superior protection for facilities and equipment by creating barriers between traffic areas and your valuable machinery.



1742	4" x 24" Round Bollard	35.0 lb	\$120.00
1742-10	4" x 24" Round Bollard-Schedule 10	22.0 lb	\$109.00
1743	4" x 36" Round Bollard	45.0 lb	\$169.00
1743-10	4" x 36" Round Bollard-Schedule 10	28.0 lb	\$154.00
1744	4" x 42" Round Bollard	50.0 lb	\$190.00
1744-10	4" x 42" Round Bollard-Schedule 10	30.0 lb	\$172.00
1749	4" Round Post Cap	2.0 lb	\$10.00
1755	5" x 24" Round Bollard	45.0 lb	\$140.00
1756	5" x 36" Round Bollard	60.0 lb	\$190.00
1757	5" x 42" Round Bollard	67.0 lb	\$211.00
1758	5" Round Post Cap	2.0 lb	\$12.00
1752	5" x 24" Square Bollard	35.0 lb	\$154.00
1753	5" x 36" Square Bollard	47.0 lb	\$204.00
1754	5" x 42" Square Bollard	53.0 lb	\$225.00
1759	5" Square Post Cap	2.0 lb	\$12.00
1763	6" x 36" Round Bollard	65.0 lb	\$190.00
1763-10	6" x 36" Round Bollard-Schedule 10	40.0 lb	\$172.00
1764	6" x 42" Round Bollard	72.0 lb	\$211.00
1764-10	6" x 42" Round Bollard-Schedule 10	44.0 lb	\$188.00
1769	6" Round Post Cap	2.0 lb	\$12.00

Call to Order **516-825-0727**
 Or Visit Us On-Line
Parkingproshop.com
 Bulk Pricing Available



Bollards

Bollards can be used both indoors and outdoors to protect work areas, racking and personnel. Plastic caps are removable on ,1-3/4, 4½” and 5½” diameter units and bollard may be filled with concrete. Steel caps are welded on the 6-5/8, 8-5/8” diameter units. Base plate includes four (4) pre-drilled mounting holes. Mounting kits and replacement caps available. Baked in powder coat finish for added toughness.

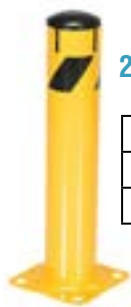

24” Yellow Steel Pipe Bollard

BOL-24-2	24”x2”	\$64.99
BOL-24-4.5	24”x4½”	\$75.99
BOL-24-5.5	24”x5½”	\$72.99

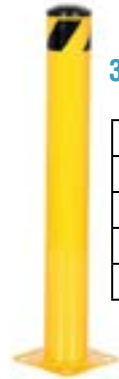

36” Yellow Steel Pipe Bollard

BOL-36-2	36”x2”	\$79.99
BOL-36-4.5	36”x4½”	\$99.99
BOL-36-5.5	36”x5½”	\$115.99
BOL-36-6.5	36”x6½”	\$145.99
BOL-36-8.5	36”x8½”	\$165.99



42” Yellow Steel Pipe Bollard

BOL-42-2	42”x2”	\$90.99
BOL-42-4.5	42”x4½”	\$117.99
BOL-42-5.5	42”x5½”	\$128.99
BOL-42-6.5	42”x6½”	\$175.99
BOL-42-8.5	42”x8½”	\$187.99



SSFB4

6.625” Diameter Fixed Stainless Steel Bollard



SSFB6

4.5” OD Fixed Stainless Steel Bollard



SSRB4

4.5” Diameter, Removable Stainless Steel Bollard



SSRB6

6.625” OD Removable Stainless Steel Bollard



48” Yellow Steel Pipe Bollard

BOL-48-2	48”x2”	\$110.99
BOL-48-4.5	48”x4½”	\$170.99
BOL-48-5.5	48”x5½”	\$182.99
BOL-48-6.5	48”x6½”	\$201.99
BOL-48-8.5	48”x8½”	\$202.99

SSFB4	4.5” Diameter Fixed Stainless Steel Bollard x 35.4” height; .138” wall, satin finish, 34lbs	\$478.99
SSFB6	6.625” Diameter Fixed Stainless Steel Bollard x 35.4” height; .138” wall, satin finish, 65lbs	\$1,260.00
SSRB4	4.5” Diameter Removable Stainless Steel Bollard x 35.4” height; .138” wall, satin finish, 40lbs	\$637.00
SSRB6	6.625” Diameter Removable Stainless Steel Bollard x 35.4” height; .138” wall, satin finish, 70lbs	\$1,464.00

Bollards

All-in-one Steel Bollard Post & Poly Post Sleeve Combos!



Model
1744PS

Model
1743PS

Model
1764PS

Model
1763PS

These combos bring you the security of our ¼" (.9 cm.) thick steel Bollards, packaged with the protection and zero maintenance of our smooth Poly Post Sleeves. The combos are available in round 4" (15.1 cm.) and 6" (22.7 cm.) bollard/sleeves 36" (136.3 cm.) high and 42" (159 cm.) high. Each combo includes a foam installation kit for a perfect fit! Kit may be ordered separately.

1743PS	4" x 36" Round Bollard w/4" x 36" Smooth Post Sleeve & Kit	10.0 lb	\$234.00
1744PS	4" x 42" Round Bollard w/4" x 42" Smooth Post Sleeve & Kit	10.0 lb	\$260.00
1763PS	6" x 36" Round Bollard w/6" x 36" Smooth Post Sleeve & Kit	10.0 lb	\$260.00
1764PS	6" x 42" Round Bollard w/6" x 42" Smooth Post Sleeve & Kit	10.0 lb	\$280.00
1739KIT	Installation Kit for Post Sleeves w/Instructions	1.0 lb	\$14.00

Call to Order **516-825-0727**
Or Visit Us On-Line
Parkingproshop.com
Bulk Pricing Available



Bollards

Poly Guide-Post Delineators™ & Poly Bollard Posts



Poly Guide-Post Delineators™ Lightweight, portable, yieldable HDPE posts used to warn, guide and delineate. Feature 3 in. (11.4 cm.) – wide reflective bands for increased visibility and are MUTCD compliant. Posts are mounted on a 10 in. (37.9 cm.) sq. poly plate with anchor slots (3/4 in./2.8 cm.) for permanent use or used with steel base for portable stability.

Poly Bollard Posts Create a low-cost, maintenance-free caution zone. These 42 in. (159 cm.) – high poly bollards are available in a 5 in. (18.9 cm.) or 7 in. (26.5 cm.) model with a poly base with anchor slots (3/4 in./2.8 cm.) that can be anchored for maximum stability or used with optional weighted steel base.

1734Y	Poly Guide-Post Delineator, Yellow w/Reflective	6 lb	\$63.00
1734LM	Poly Guide-Post Delineator, Lime w/Reflective	6 lb	\$63.00
1734OR	Poly Guide-Post Delineator, Orange w/Reflective	6 lb	\$63.00
1731	5" x 42" Yellow Poly Bollard Post	5.0 lb	\$43.00
1733	7" x 42" Yellow Poly Bollard Post	8.0 lb	\$50.00
1731BASE	Steel Weighted Base for 1731 & 1733	12.0 lb	\$44.00

Standard Bollard Covers

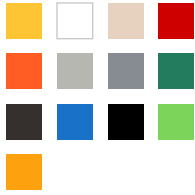

4" BollardGard Reflective Bollard Covers

- 4.7" ID x 52", 64", or 72" lengths
- 1/8" wall thickness - HDPE
- 5 year warranty against cracking and fading
- Having a hard time deciding on what color? Request our Bollard Cover Color Sample Kit
- Access our BollardGard Sizing information to help determine what size bollard cover fits your steel pipe

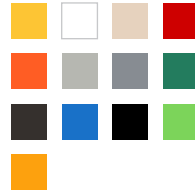

7" BollardGard Reflective Bollards

- 7.1" ID x 52", 60" or 72" lengths
- 1/8" wall thickness - HDPE
- 5 year warranty against cracking and fading
- Having a hard time deciding on what color? Request our Bollard Cover Color Sample Kit
- Access our BollardGard Sizing information to help determine what size bollard cover fits your steel pipe

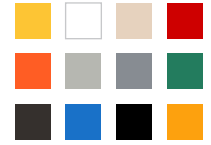

8" BollardGard Bollard Covers

- 9.125" ID x 72" lengths
- 1/8" wall thickness - HDPE
- 5 year warranty against cracking and fading
- Having a hard time deciding on what color? Request our Post Cover Color Sample Kit
- Access our BollardGard Sizing information to help determine what size bollard cover fits your steel pipe



11" BollardGard Bollard Covers

- 11.125" ID x 60" lengths
- .187" wall thickness
- 5 year warranty against cracking and fading
- Having a hard time deciding on what color? Request our Bollard Cover Color Sample Kit
- Access our BollardGard Sizing information to help determine what size bollard cover fits your steel pipe



13" BollardGard Bollard Cover, Post Sleeve

- 13.167" ID x 60" lengths
- .200" wall thickness - LDPE
- 5 year warranty against cracking and fading on our post sleeves
- Access our BollardGard Sizing information to help determine what size bollard cover fits your steel pipe

BC452	4"x52" Bollard Cover (4.700" ID)	\$46.00
BC752	7"x52" Bollard Cover (7.125" ID)	\$56.00
BC872	8"x72" Bollard Cover (9.125" ID)	\$99.00
BC1160	11"x60" Bollard Cover (11.125" ID)	\$120.00
BC1360	13"x60" Bollard Cover (13.125" ID)	\$159.00
SBC6560	6.5" x 60" Bollardgard – (6.5" ID x 6.5" ID with a .188" wall; two 1" recesses 10" apart with a peaked top)	\$118.00

Call to Order **516-825-0727**
 Or Visit Us On-Line
Parkingproshop.com
 Bulk Pricing Available



Decorative Bollard Covers



7" x 65" Charcoal Grey Granite Slant Top Decorative Bollard Cover

- 7.1" ID x 65" height x .188" wall
- Fits up to a 6-5/8" pipe



7" x 65" Tan Granite Slant Top Decorative Bollard Cover

- 7.1" ID x 65" height x .188" wall
- Fits up to a 6-5/8" pipe



7" x 65" Brown Granite Slant Top Decorative Bollard Cover

- 7.1" ID x 65" height x .188" wall
- Fits up to a 6-5/8" pipe



7" x 65" Black Slant Top Decorative Bollard Cover

- 7.1" ID x 65" height x .188" wall
- Fits up to a 6-5/8" pipe



8" x 65" Charcoal Grey Granite Decorative Bollard Cover with Slant Top

- 9.125" ID x 65" height x .188" wall
- Fits up to an 8-5/8" pipe



8" x 65" Tan Granite Decorative Bollard Cover with Slant Top

- 9.125" ID x 65" height x .188" wall
- Fits up to an 8-5/8" pipe



8" x 65" Brown Granite Decorative Bollard Cover with Slant Top

- 9.125" ID x 65" height x .188" wall
- Fits up to an 8-5/8" pipe



8" x 65" Black Slant Top Decorative Bollard Cover

- 9.125" ID x 65" height x .188" wall
- Fits up to an 8-5/8" pipe



11" x 39" Charcoal Granite Slant Top Decorative Bollard Cover

- 9.125" ID x 65" height x .188" wall
- Fits up to an 8-5/8" pipe

- Quick and secure installation with Gripper Tabs
- 5 year warranty against cracking and fading

DBC765CC	7" x 65" Charcoal Gray (Ash #9966) Granite Decorative Slant Top Bollard Cover (7.1" ID x .188" wall)	\$102.00
DBC765TG	7" x 65" Tan (Sandstone #9206) Granite Decorative Slant Top Bollard Cover (7.1" ID x .188" wall)	\$102.00
DBC765BNG	7" x 65" Brown (Dark Monzonite #14042) Granite Decorative Slant Top Bollard Cover (7.1" ID)	\$102.00
DBC765BKN	7" x 65" Black Decorative Slant Top Bollard Cover (7.1" ID x .188" wall)	\$80.00
DBC865CC	8" x 65" Charcoal Gray (Ash #9966) Granite Decorative Slant Top Bollard Cover (9.125" ID x .188" wall)	\$121.00
DBC865TG	8" x 65" Tan (Sandstone #9206) Granite Decorative Slant Top Bollard Cover (9.125" ID x .188" wall)	\$121.00
DBC865BNG	8" x 65" Brown (Dark Monzonite #14042) Granite Decorative Slant Top Bollard Cover (9.125" ID x .188" wall)	\$121.00
DBC865BKN	8" x 65" Black Decorative Slant Top Bollard Cover (9.125" ID x .188" wall)	\$94.00
DBC1139CC	11"x39" Charcoal Gray (Ash #9966) Granite Decorative Slant Top Bollard Cover (11.15" ID) (Max pipe height - 27")	\$138.00

Square Bollard Covers

Square Bollard Covers



6" Square BollardGard Bollard Covers

- 6.5" ID x 60" lengths
- .188" wall thickness - LDPE
- 5 year warranty against cracking and fading

Decorative Square Covers



6.5" x 60" Brown Square Granite Decorative Bollard Cover

- 9.125" ID x 65" height x .188" wall
- Fits up to an 8-5/8" pipe

Padded Bollards



7" x 40" Bollard Pole Soft Padded Cover

- Fits up to 7" diameter bollard post x 40" tall
- Waterproof, fade resistant and mold/mildew proof



7" x 50" Bollard Pole Soft Padded Cover

- Fits up to 7" diameter bollard post x 50" tall
- Waterproof, fade resistant and mold/mildew proof



BollardGard Anywhere - 4" x 52"

- Heavy duty recycled rubber base
- Includes one 4" Bollardgard bollard cover
- Easily disassembled for transport



BollardGard Anywhere - 7" x 52"

- Heavy duty recycled rubber base
- Includes one 7" Bollardgard bollard cover
- Easily disassembled for transport



BollardGard Anywhere Kit Parking Bollard

- (3) BollardGard Anywhere w/chain
- Spans up to 13'
- Limits access
- Indoor/outdoor use

BollardGard Anywhere™

SBC6560 Standard*	6.5" x 60" Square Bollardgard – (6.5" ID x 6.5" ID with a .188" wall; two 1" recesses 10" apart with a peaked top)	\$78.00
SBC6560BNG	6.5" x 60" Brown (Dark Monzonite #14042) Square Granite Bollardgard – (6.5" ID x 6.5" ID with a .188" wall; two 1" recesses 10" apart with a peaked top)	\$102.00
BP-40	7" x 40" Bollard Pole Soft Padded Cover	\$88.00
BP-50	7" x 50" Bollard Pole Soft Padded Cover	\$100.00
BGAW452	BollardGard Anywhere - 4" x 52" Cover with 25 lb Octagon Rubber Base, with (4) set screws to permanently attach the cover to the base	\$114.00
BGAW752	BollardGard Anywhere - 7" x 52" Cover with 25 lb Octagon Rubber Base, with (4) set screws to permanently attach the cover to the base	\$117.00
BGAWKIT	BollardGard Anywhere Kit – includes (3) BGAW (with screws), (6) threaded inserts & jack nuts, installed 2" below the bottom recess (2) on each cover, (6) eyebolts, (2) sections of 6' yellow chain, & (6) yellow C-links	\$392.76

Call to Order **516-825-0727**
 Or Visit Us On-Line
Parkingproshop.com
 Bulk Pricing Available



Bollard Covers

HDPE Smooth Bollard Post Sleeves

Smooth Bollard Post Sleeves are available to fit over 4 in. (10.2 cm.), 6 in. (15.2 cm.) and 8 in. (20.3 cm.) pipe and are available in red, yellow, blue and white (available in other colors for quantity orders). The smooth sleeves are 56 in. (142.2 cm.) in length and provide the same maintenance-free protection as the original bumper post sleeves. Sleeve height may be easily trimmed for an exact fit.

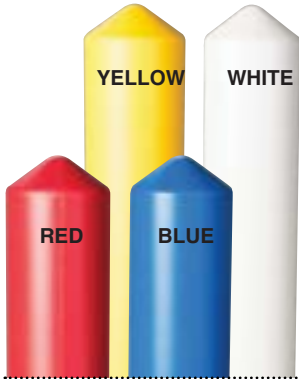

1735	4" Bumper Post Sleeve-Smooth Sided	4 lb	\$58.00
1736	6" Bumper Post Sleeve-Smooth Sided	6 lb	\$64.00
1737	8" Bumper Post Sleeve-Smooth Sided	8 lb	\$78.00

Yellow HDPE Smooth Bollard Post Sleeves with Reflective Stripes

HDPE Smooth Bollard Post Sleeves with reflective stripes. Keep your facility safe and protected with sleeves to fit over 4 in. (10.2 cm.), 6 in. (15.2 cm.) and 8 in. (20.3 cm.) pipe in HDPE yellow with two red stripes. Sleeve height may be easily trimmed for an exact fit.



1735RWS	4" Bumper Post Sleeve w/Reflective Strip-Red w/3/4" White Stripes	4 lb	\$63.00
1736RWS	6" Bumper Post Sleeve w/Reflective Strip-Red w/3/4" White Stripes	6 lb	\$69.00
1737RWS	8" Bumper Post Sleeve w/Reflective Strip-Red w/3/4" White Stripes	8 lb	\$81.00

Red HDPE Smooth Bollard Post Sleeves with Reflective Stripes

HDPE Smooth Bollard Post Sleeves with reflective stripes. Keep your facility safe and protected with sleeves to fit over 4 in. (10.2 cm.), 6 in. (15.2 cm.) and 8 in. (20.3 cm.) pipe in HDPE red with two white stripes. Sleeve height may be easily trimmed for an exact fit.



1735YRS	4" Bumper Post Sleeve w/Reflective Strip-Yellow w/3/4" Red Stripes	4 lb	\$63.00
1736YRS	6" Bumper Post Sleeve w/Reflective Strip-Yellow w/3/4" Red Stripes	6 lb	\$69.00
1737YRS	8" Bumper Post Sleeve w/Reflective Strip-Yellow w/3/4" Red Stripes	8 lb	\$81.00

Decorative Post Sleeves

Beautiful HDPE post sleeves slip over 4 in. (10.2 cm.) x 4 in. (10.2 cm.) wooden or steel posts or can be used free standing with optional rubber base. Available in three styles. Includes 6 ft. (182.9 cm.) of poly chain.



1713BLK	Classic Post Sleeve-Black	10.0 lb	\$88.00
1714BLK	Golf Traditions Post Sleeve-Black	10.0 lb	\$88.00
1714WHT	Golf Traditions Post Sleeve-White	10.0 lb	\$88.00
1715BLK	Hitching Post Sleeve-Black	10.0 lb	\$97.00
1718BASE	Molded Rubber Base	10.0 lb	\$26.00
1719BLK	Replacement Chain Kit-Black	1.0 lb	\$34.00
1719WHT	Replacement Chain Kit-White	1.0 lb	\$34.00

Bollard Covers

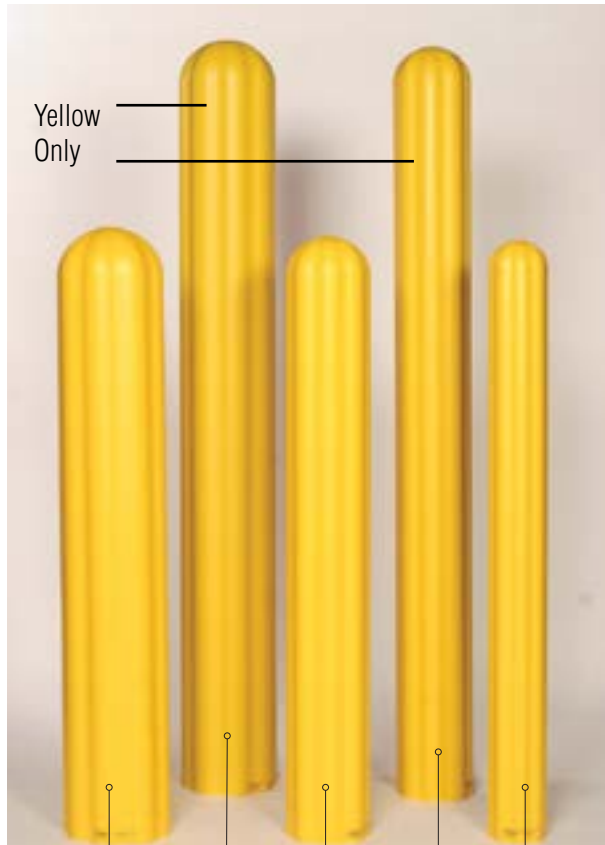

Original HDPE Bumper Post Sleeves



Model 1730BR 6" (15.2 cm.) (Brown)

Poly Base

Poly bases available for 4" (10.2 cm.) and 6" (15.2 cm.) post sleeves to convert into poly bollard.

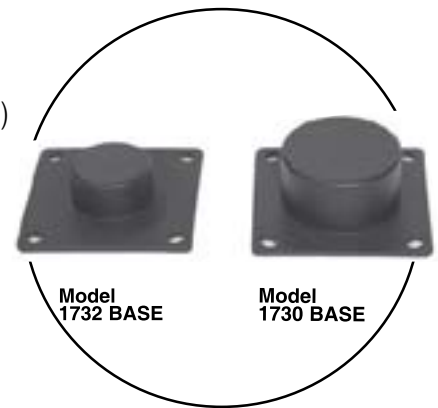

The Original HDPE Bumper Post Sleeves have a vertical fluted design to provide extra protection and easier installation. They come 56 in. (142.24 cm.) in length (to fit 4 in./10.2 cm., 6 in./15.2 cm. and 8 in./20.3 cm. pipe) and are available in yellow, red, blue, white, green, orange, lime, brown and black. The 72 in. (182.9 cm.) length Bumper Post Sleeves (to fit 6 in./15.2 cm. and 8 in./20.3 cm. pipe) are available in yellow only. Sleeve height may be easily trimmed for an exact fit.

1732	4" Bumper Post Sleeve	5 lb	\$58.00
1732BASE	Poly Base for 4" Post Sleeves	1 lb	\$19.00
1730	6" Bumper Post Sleeve	8 lb	\$64.00
1730-72	6" Bumper Post Sleeve-72" Long	11 lb	\$78.00
1730BASE	Poly Base for 6" Post Sleeves	1 lb	\$19.00
1738	8" Bumper Post Sleeve	9 lb	\$78.00
1738-72	8" Bumper Post Sleeve-72" Long	15	\$93.00

Call to Order **516-825-0727**
 Or Visit Us On-Line
Parkingproshop.com
 Bulk Pricing Available

Jump Packs and Cables, Lockout Tool Kit



Jump Pack

TCB-ES5000

1 Unit | \$191.99

- Easy to use and lightweight, it is the ideal entry level professional jump starter
- Its compact size, rugged case and ability to jump up to 5 vehicles on a single charge make the ES5000 a perfect companion for any situation in which you need portable power
- 900 Peak Amps
- 300 Cranking Amps
- ES Series battery designed specifically for vehicle jump starting
- Automatic recharging
- LED battery status indicator
- 21" #4 AWG cables
- Industrial Grade Hot Jaw™ clamps
- DC outlet to power 12 Volt accessories
- 1 year limited warranty



Jump Cables

ATD-79700

1 Unit | \$32.99

- Copper clad aluminum cables
- Tangle free cables remain flexible to -40° F
- 600 Amp parrot clamps



Lockout Tool Kit

STE-32900

Includes:

- (1) Universal lockout tool for most standard locks
- (1) Button jack lockout tool for button-type locks
- (1) Vent key lockout tool for truck and van vent windows
- (1) Slide-unlocked tool
- (1) K-key for opening locks directly through the key hole
- (1) Wedge

\$71.99

Wheel Clamp, Wheel Boot



Wheel Boot Lock Clamp

- Heavy Duty Steel, Plastic Grippped tips to avoid damaging wheel rims., Fits most tires by adjusting to the tire width., Tire Width Sizing: 6 ¾” – 10 ½”
- No Assembly Required - Instructions included
- Easy to install and remove
- One (1) Wheel Tire Lock
- Two (2) Keys

1 Unit	\$27.99
--------	---------



Heavy Duty Wheel Boot

- Wheel immobilizer can be used for parking enforcement or theft deterrent
- Jawless “Hook-Loc” attachment system eliminates possibility of damaging, scratching or marring
- Fits U.S. and foreign subcompact to full size vehicles and light trucks
- Heavy Duty: Fits most Wheels and Tires 2” - 17.5” wide x 12”- 24” diameter
- Domed design prevents removal of the wheel; Available in 12”, 14” or 15” domed wheel covers
- Installs in less than one minute
- No assembly required

HRV_12	12”x13.25”x32.5”	24.5 lbs	\$790.00
HRV_14	14”x13.25”x32”	25.25 lbs	\$805.00
HRV_15	16”x13.25”x32.5”	26.25 lbs	\$820.00

Call to Order **516-825-0727**
 Or Visit Us On-Line
Parkingproshop.com
 Bulk Pricing Available



Bases



\$48.30

Square Sign Base

18"(L) x 18"(W) x 2"
" (H). (Square);
20 lbs.
Accommodates 2" PVC
sign post
(SB20)



\$65.60

Square Sign Base

18"(L) x 18"(W) x 3"
" (H). (Octagon);
30 lbs.
Accommodates 1.5" PVC
sign post
(SB30)



\$115.40

Octagon Sig Base

18"(L) x 18"(W) x 6"
" (H). (Octagon);
60 lbs.
Accommodates 1.5" PVC
sign post
(SB60)



\$190.00

Cast Iron Base and Post

Base: 14" and 18"
Post: 48"
black



\$21.80

U Channel Adapter

Post Sizes Available
4', 5', 6'
(SBUC)



\$88.50

Economy Base

Empty 8lb filled
60lb
(ECOB)



\$180.00

Rubber Form Base PVC Post

72lb
(RFBPVC)



\$180.00

Rubber Form Base Square Post

72lb
(RFBSP)

Sign Systems



Hardware Included

20lb Sign System

- w/42" PVC post
- White PVC



Hardware Included

30lb Sign System

- w/42" PVC post

1-3	\$87.99
4-9	\$83.99
10+	\$78.99
Wheels	\$20



Hardware Included

60lb Sign System

- w/42" PVC post

1-3	\$143.99
4-9	\$137.99
10+	\$131.99
Wheels	\$20



Hardware Included

20lb Cast Iron Sign System

- w/48" Iron Post
- Black Iron Post

1-3	\$143.99
4-9	\$137.99
10+	\$131.99
Wheels	\$20



Hardware Included

Economy Sign System

- 48" Metal Post
- 60lb when filled with water/sand

1-3	\$101.99
4-9	\$99.99
10+	\$251.99



Hardware Included

Wind Resistant Sign System

- Just Tip And Roll
- w/42" PVC post
- 72lb base

1-3	\$203.99
4-9	\$197.99
10+	\$191.99



Hardware Included

Wind Resistant Sign System

- Just Tip And Roll
- w/42" Metal post
- 72lb base

1-3	\$263.99
4-9	\$257.99
10+	\$251.99

Call to Order **516-825-0727**
 Or Visit Us On-Line
Parkingproshop.com
 Bulk Pricing Available



Keyboard

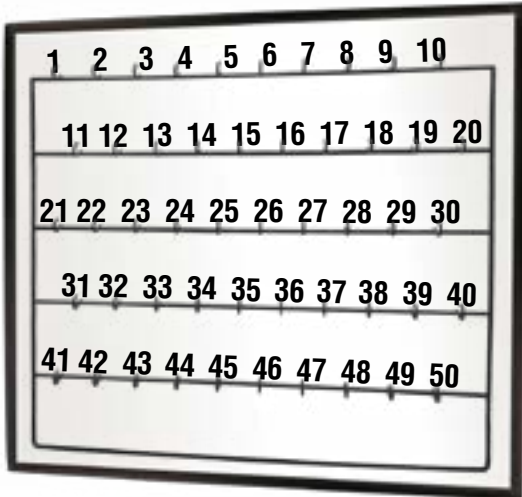

KB50

50 Keys

1-3	\$95.99
4-9	\$89.99
10+	\$84.99

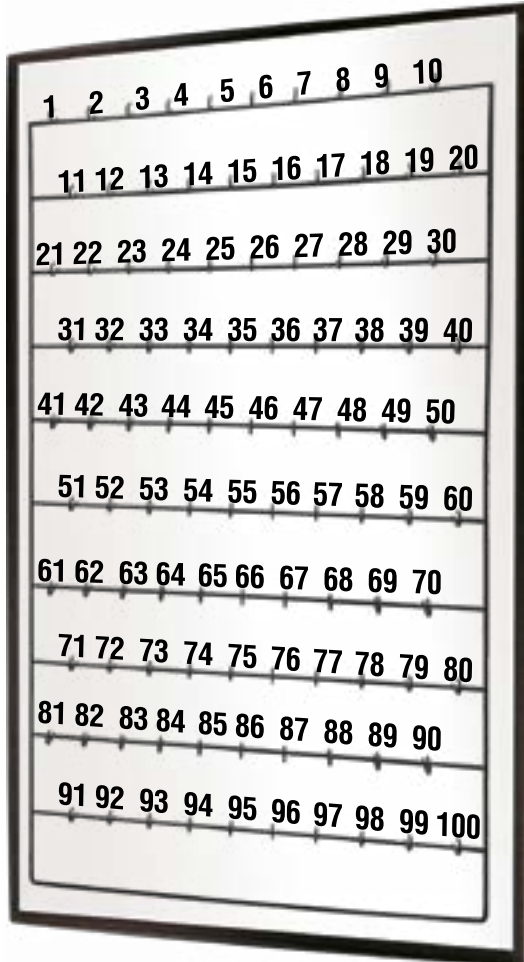

KB100

100 Keys

1-3	\$167.99
4-9	\$161.99
10+	\$155.99

- 10mm coroplast
- Custom logo print available FREE
- 50 Keyboard 24"x24"x1"
- 100 Keyboard 24"x44"x1"
- Metal Hook Frame

Acrylic Portable Tip Box

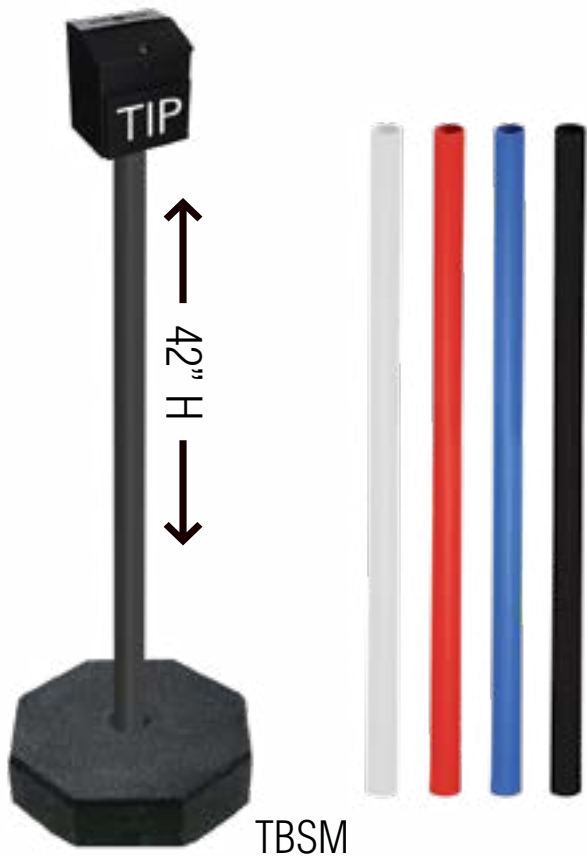

TBSM

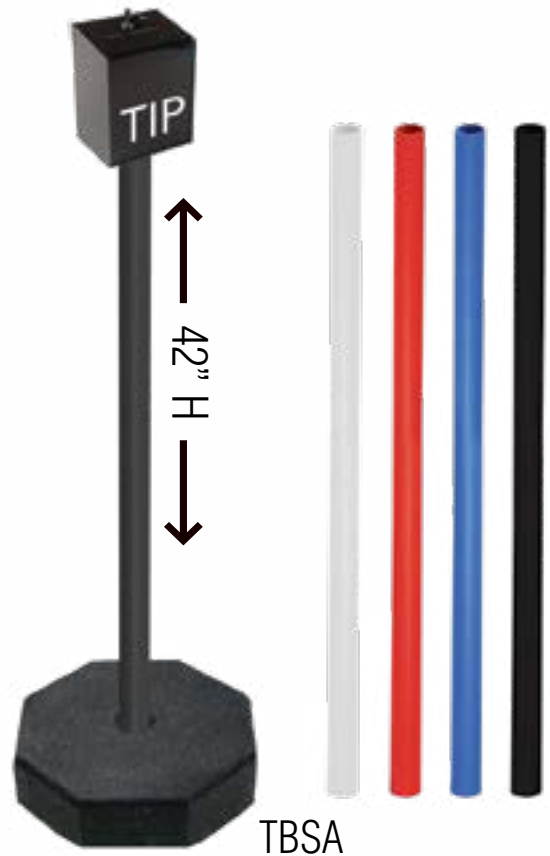

TBSA

Metal Portable Tip Box

Metal, Black w/lock

Box Size: 7.125" w x 8.5" h x 6" d

Post 1.5" Black PVC sch40

Glossy

Base 18"x18"x3" 30lb

\$178.00

Acrylic Portable Tip Box

Acrylic, Black w/lock

Box Size: 8"x6.5"

Post 1.5" Black PVC sch40

Glossy

Base 18"x18"x3" 30lb

\$190.00

Call to Order **516-825-0727**

Or Visit Us On-Line

Parkingproshop.com

Bulk Pricing Available



Flags and Wands

Flags



SF-1830



SF24-36

Vinyl Flag w/30" Dowel

18"x18"

1-24	\$3.50
25+	\$2.99

Vinyl Flag w/36" Dowel

24"x24"

1-24	\$4.79
25+	\$4.19

• Plastic Wands



WAND-RO



- 16.25"
- Batteries not Included

1-24	\$10.99
25+	\$9.99



WAND-W



- 21"
- Batteries not Included

1-24	\$11.99
25+	\$10.99

Wands

• Night Stick **NIGHTSTICK** LED BATTERIES INCLUDED



NSP-1634



NSP-1632



NSP-1636



• LED Wand • 3AAA Bat Inc

• Water Proof	\$16.99
• Impact Resistance	
• 18 hr Run Time	
• 16.5" Long	

Custom Traffic Barricade

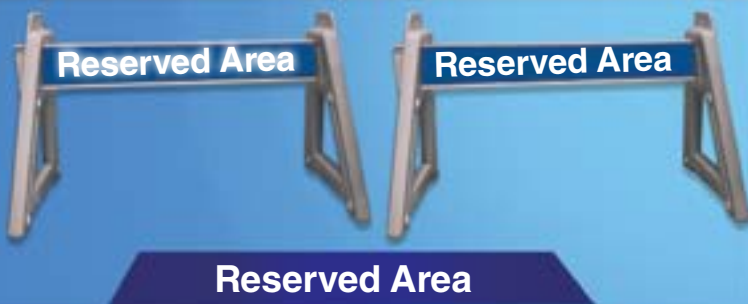

- A-Frame is made of rigid impact resistant polyethylene 40" H
- Leg is sand fillable for ballasting
- Stackable for storage and transportation
- Impact resistant polyethylene 1" x 8" x 72" I Beam
- Engineer Grade reflective lettering
- Choose your color

\$298.99

**Order 5
Get
Free Shipping**



Call to Order **516-825-0727**
Or Visit Us On-Line
Parkingproshop.com
Bulk Pricing Available



FlexPost-XL™ ACCESSORIES



\$324.99

52" FLEXBOLLARD SYSTEM

#B52-C - Concrete
 #B52-A - Asphalt
 #B52-G - Natural Ground
 #B52-D - Adhesive
 Bollards come in 4.5" (slim) and 7" Diameters



\$324.99

32" FLEXBOLLARD SYSTEM

#B32-C - Concrete
 #B32-A - Asphalt
 #B32-G - Natural Ground
 #B32-D - Adhesive
 Bollards come in 4.5" (slim) and 7" Diameters



\$338.99

72" FLEXBOLLARD SYSTEM

#B72-C - Concrete
 #B72-A - Asphalt
 #B72-G - Natural Ground
 #B72-D - Adhesive
 Bollards come in 4.5" (slim) and 7" Diameters



\$360.00

52" FLEXBOLLARD W/8FT SIGNPOST SYSTEM

#B52/8-C - Concrete
 #B52/8-A - Asphalt
 #B52/8-G - Natural Ground
 #B52/8-D - Adhesive
 Bollards come in 4.5" (slim) and 7" Diameters



78"

102"

\$237.99

\$259.99

Standard FlexPost

#STD-C/#RGD-C - Concrete
 #STD-A/#RGD-A - Asphalt
 #STD-G/#RGD-G - Natural Ground
 #STD-D/#RGD-D - Adhesive



\$442.99

XL REPLACEMENT BASE ALONE

(*Anchoring kit sold separately*)
 #RE-XL-BP



\$550.99

Flex Bollard XL 52"

#XL-B52-C - Concrete
 #XL-B52-A - Asphalt
 #XL-B52-D - Adhesive



\$562.99

72" FLEXBOLLARD XL

#XL-B72-C - Concrete
 #XL-B72-A - Asphalt
 #XL-B72-D - Adhesive



\$442.99

FLEXPOST XL - FINISHED HEIGHT 6.5'

INCLUDES SIGN BRACKETS (#A-XL-SB)
 #XL-6PSK-C - Concrete
 #XL-6PSK-A - Asphalt
 #XL-6PSK-D - Adhesive



\$598.99

52" FLEXBOLLARD XL 9' or 8' SIGNPOST

INCLUDES SIGN BRACKETS (#A-XL-SB)
 #XL-B52/9-C - Concrete
 #XL-B52/9-A - Asphalt
 #XL-B52/9-D - Adhesive
 #XL-B52/8-C - Concrete
 #XL-B52/8-A - Asphalt
 #XL-B52/8-D - Adhesive



\$454.99

52" FLEXBOLLARD W/8FT SIGNPOST SYSTEM

#XL-9PSK-C - Concrete/#XL-8PSK-C - Concrete
 #XL-9PSK-A - Asphalt/#XL-8PSK-A - Asphalt
 #XL-9PSK-D - Adhesive/#XL-8PSK-D - Adhesive



Accessories



6' **\$34.99**

Optional 6' Sleeve
(#A-PS6)
Optional 8' Sleeve
(#A-PS8)



\$24.99

Optional 6ft Black Powder Coated Post Upgrade
#A-6BP



\$58.99

Optional 8ft Black Powder Coated Post Upgrade
#A-8BP



\$27.99

Optional 8ft Signpost
#A-8BP



\$45.99

Replacement 6ft Galvanized Signpost
#RE-6P



\$64.99

Replacement 6ft Black Powder Coated Signpost
#RE-6BP



\$57.99

Replacement 8ft Galvanized Signpost
#RE-8P



\$85.99

Replacement 8ft Black Coated Signpost
#RE-8BP



\$34.99

Optional Sign Brackets
(1 set of 2 Brackets)
#A-SB



\$46.99

Optional 18lb Portable Base
#A-PB



\$46.99

Optional Spring Cover
#RE-SC



\$46.99

Concrete Mounting Fastener Kit
#RE-C



\$46.99

Asphalt Mounting Fastener Kit
#RE-A



\$46.99

Adhesive Mounting Fastener Kit
#RE-D



\$88.99

Ground Spike
#RE-GS



\$88.99

Base Plate
#RE-BP



\$24.99

Optional ADA Handicap Decal
#RE-ADA



\$88.99

Replacement Spring Kit
#RE-SK



\$88.99

Replacement Rigid Adaptor Kit
#RE-RA



\$88.99

Replacement Bollard Cover
#RE-B52
*Bollards Available as "Slim", add "S" before any part number



\$34.99

Concrete Anchoring Kit
#RE-C



\$34.99

Asphalt Anchoring Kit
#RE-A



\$34.99

Adhesive Anchoring Kit
#RE-D



\$70.99

Detent Bracket Kit
#A-XL-DK



\$34.99

Sign Bracket Kit
#A-XL-SB



\$70.99

9' Replacement Post (105")
#RE-XL-9P
8' Replacement Post (99")
#RE-XL-8P



\$58.99

6.5' Replacement Post (75")
#RE-XL-6P

FLEX POST

Call to Order **516-825-0727**
Or Visit Us On-Line
Parkingproshop.com
Bulk Pricing Available

P PARKING
PROSHOP.COM
516-825-0727



WOSB CERTIFIED

FLEXPOST-SM™ PRODUCTS



\$166.99

**55" SIGN POST/
CHANNELIZER POST AND
BASE**

- #SM-C-55P– Concrete
- #SM-A-55P– Asphalt
- #SM-G-55P– Ground
- #SM-D-55P– Adhesive



\$166.99

**42" SIGN POST
/ CHANNELIZER POST
AND BASE**

- #SM-C-42P– Concrete
- #SM-A-42P– Asphalt
- #SM-G-42P– Ground
- #SM-D-42P– Adhesive



\$169.99

**GUIDE POST/ DELINATOR
AND BASE**

- #SM-C-GP– Concrete
- #SM-A-GP– Asphalt
- #SM-G-GP– Ground
- #SM-D-GP– Adhesive



\$169.99

**DELINATOR PADDLE
AND BASE**

- #SM-C-DP– Concrete
- #SM-A-DP– Asphalt
- #SM-G-DP– Ground
- #SM-D-DP– Adhesive



\$238.99

**UNITS with 18LB
PORTABLE BASE**

SM-55P + A-SM-PB18



\$238.99

**UNITS with 18LB
PORTABLE BASE**

SM-42P + A-SM-PB18



\$238.99

**UNITS with 18LB
PORTABLE BASE**

SM-GP + A-SM-PB18



\$238.99

**with 18LB PORTABLE
BASE**

SM-DP + A-SM-PB18
(No Decal)



FlexPost-SM™ Accessories



\$39.99

**PEDESTRIAN
CROSSWALK
DECAL**
#A-PED



\$39.99

**PEDESTRIAN
STOP
CROSSWALK
DECAL**
#A-PED-S



\$24.99

**CONCRETE
MOUNTING
FASTENER KIT**
#RE-SM-C



\$24.99

**ASPHALT
MOUNTING
FASTENER KIT**
#RE-SM-A



\$24.99

**ADHESIVE
MOUNTING
FASTENER KIT**
#RE-D



\$34.99

**SM SIGN
BRACKET**
#A-SM-SB



\$119.99

**GUIDE POST
/ DELINEATOR
ALONE (NO BASE)**
#RE-SM-GP



\$119.99

**55" SIGN POST
/ CHANNELIZER POST
ALONE (NO BASE)**
#RE-SM-55P



\$119.99

**42" SIGN POST
/ CHANNELIZER POST
ALONE (NO BASE)**
#RE-SM-42P



\$119.99

**DELINEATOR
PADDLE ALONE
(NO BASE)**
#RE-SM-DP



\$24.99

**TURN AND
LOCK BASE**
#RE-SM-BP



\$45.99

**TURN AND
GROUND SPIKE**
#A-SM-GS

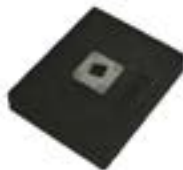

\$70.99

**TURN AND LOCK
18LB PORTABLE
Base**
#A-SM-PB18



\$39.99

**BLACK/YELLOW
DIAGONAL DECAL**
#A-YBDP



\$39.99

RED/WHITE DECAL
#A-RWBP



\$39.99

**BLACK/YELLOW
CHEVRON DECAL**
#A-YBCD

**FLEX
POST**

Call to Order **516-825-0727**
Or Visit Us On-Line
Parkingproshop.com
Bulk Pricing Available

P PARKING
PROSHOP.COM
516-825-0727



Delineators



RP3420WB

Repo Post

- Post is constructed from UV Stabilized polymer, Dioxin-Free
- Surface mount for temporary or permanent installations
- ABS base made from 100% recycled material



521221



521312W



522209W



521039W



521039

Boomerang Delineators

- Meets all state specifications for two-way, two-lane delineators.
- The Boomerang base transfers the stress from impacts to the base, giving longer service life to the HDPE tube
- Round tube provides 360 degree visibility
- Boomerang is perfect for parking lots, islands, work zones, concrete barriers, gore zones, and bridges



523561

Boomerang Reboundable Base

- The Boomerang base transfers the stress from impacts to the base, giving longer service life to the HDPE tube
- Boomerang is perfect for parking lots, islands, work zones, concrete barriers, gore zones, and bridges
- Three times the elasticity of conventional rubber bases



523574

Boomerang Heavy Duty Base

- The Boomerang base transfers the stress from impacts to the base, giving longer service life to the HDPE tube
- Boomerang is perfect for parking lots, islands, work zones, concrete barriers, gore zones, and bridges
- Three times the elasticity of conventional rubber bases



523600

Boomerang Bolt Down Plate

- Square 8.5"x8.5" ABS base
- Designed to be used with Boomerang delineators
- Made from 100% recycled material

RP3420WB	3" Orange Repo Post x 42" (RP342), Hi-Intensity 3" x 9" White Sheeting (HI39S) with a Repo Base (RP3Base) (Also available in white)	\$31.00
521221	TD5200 Boomerang Delineator 2.25" x 42" Orange Post, Boomerang Base, 2-3" White HI Bands	\$38.00
521312W	TD5200 Boomerang Delineator 2.25" x 48" White Post & Boomerang Base, 2-3" White HI Bands	\$39.00
522209W	TD5200 3" Flat x 48" White Post & Boomerang Base, No reflective	\$37.10
521039W	TD5200 Boomerang Delineator 2.25" x 36" White Post, Boomerang Base, 2-3" White HI Bands	\$36.40
521039	TD5200 Boomerang Delineator 2.25" x 36" Orange Post, Boomerang Base, 2-3" White HI Bands	\$36.40
523561	Boomerang RB, Reboundable Base only, for delineators and markers	\$24.50
523574	Boomerang HB, Heavy Duty Base Only, for channelization & signs	\$24.50
523600	Boomerang FB, Bolt-Down Plate	\$12.30

Multipurpose Post



Multipurpose Post Fixed”

- Post is constructed of flexible plastic that is resistant to: ultraviolet light, ozone, and hydrocarbons.
- Unit has a reactive spring assembly that rebounds to upright when struck.
- Meets MUTCD Specifications
- NTPEP Tested (Report #99)
- Base & Hardware Sold Separately



Multipurpose Post Quick Release

- Post is constructed of flexible plastic that is resistant to: ultraviolet light, ozone, and hydrocarbons.
- Unit has a reactive spring assembly that rebounds to upright when struck.
- Meets MUTCD Specifications
- NTPEP Tested (Report #99)
- Base & Hardware Sold Separately



2” Tubular Surface Mount Delineators

- Pricing on the Tubular Surface Mount Delineators come with Post, Collars, and Black Base (caps must be purchased separately)
- Tubular Delineators can be applied with Butyl Pads (see below) or asphalt/concrete anchors (buy locally)
- Tubular delineators come in various colors: Orange, Yellow, Black, Green, and White
- Tubular delineators are offered in 36” and 48”



3” Tubular Surface Mount Delineators

- Pricing on the Tubular Surface Mount Delineators come with Post, Collars, and Black Base
- Tubular Delins can be applied with Butyl Pads as well as asphalt/concrete anchors (not sold at Cortina)
- Tubular delineators come in various colors: Orange, Yellow, White
- Tubular delineators are offered in 28” and 36”



Surface Mount Base Fixed

- Surface mount fixed base for use with Multipurpose posts, Tuff Posts, and Sign Posts
- each - 16mm x 3” plastic sleeve, 1/2”x4” lag screw, and 1– 1/4” metal washer



Surface Mount Base Quick Release”

- Surface mount quick release base for use with Multipurpose posts, Tuff Posts, and Sign Posts
- (4) each - 16mm x 3” plastic sleeve, 1/2”x4” lag screw, and 1– 1/4” metal washer

MP2-36-F	Multipurpose Post, 2.375” x 36” , Fixed(BS-SMFB is needed for installation)	\$86.00
MP2-42-F	Multipurpose Post, 2.375” x 42” , Fixed (BS-SMFB is needed for installation)	\$88.00
MP2-48-F	Multipurpose Post, 2.375” x 48” , Fixed (BS-SMFB is needed for installation)	\$90.00
MP2-36-Q	Multipurpose Post, 2.375” x 36” , Quick Release (BS-SMQB is needed for installation)	\$96.00
MP2-42-Q	Multipurpose Post, 2.375” x 42” , Quick Release (BS-SMQB is needed for installation)	\$97.00
MP2-48-Q	Multipurpose Post, 2.375” x 48” , Quick Release (BS-SMQB is needed for installation)	\$97.50
04-36	36” Tubular Delin (2)3” High Intensity Prismatic Collars	\$66.00
04-48	48” Tubular Delin (2)3” High Intensity Prismatic Collars	\$79.00
04-48-BEC	Black End Cap for Tubular Marker	\$1.80
04-10-BASE	Black Base for Tubular Markers - Universal for all sizes	\$15.00
04-728	28” Tubular Delin Post - (2)3” High Intensity Prismatic Collars	\$61.50
04-736	36” Tubular Delin Post - (2)3” High Intensity Prismatic Collars	\$67.00
04-10-BASE	Black Base for Tubular Markers - Universal for all sizes	\$15.00
4-10-PAD	Butyl Pad - Mounting Pad for Adhesive Mount Tubular Delineator	\$6.00
BS-SMFB	Surface Mount Base, Fixed Style, Black	\$32.00
BS-SMQB	Surface Mount Base, Quick Release, Black	\$34.00

Call to Order **516-825-0727**
 Or Visit Us On-Line
Parkingproshop.com
 Bulk Pricing Available





Enviro-Cone - 18", 3lb Orange

- with 6" reflective collar, Orange.
- 18" Enviro-Cones can be made with 3lb bases. 1 6" reflective collar or no reflective collars.



Enviro-Cone - 18", 3lb Lime Green

- with 4" & 6" reflective collars, Lime Green.
- 28" Enviro-Cones can be made with 7lb, 10lb, or 12lb bases. 1 4", 1 6", 1 4" & 6", or no reflective collars.



Enviro-Cone - 28", 10lb Orange

- with 4" & 6" reflective collars, Orange.
- 28" Enviro-Cones can be made with 7lb, 10lb, or 12lb bases. 1 4", 1 6", 1 4" & 6", or no reflective collars.



Enviro-Cone - 28", 10lb Lime Green

- with 4" & 6" reflective collars, Lime Green.
- 28" Enviro-Cones can be made with 7lb, 10lb, or 12lb bases. 1 4", 1 6", 1 4" & 6", or no reflective collars.



Enviro-Cone - 36", 12lb Orange

- with 4" & 6" reflective collars, Orange.
- 36" Enviro-Cones can be made with 10lb or 12lb bases; 1 4", 1 6", 1 4" & 6", or no reflective collars.



Enviro-Cone - 36", 12lb Lime Green

- with 4" & 6" reflective collars, Lime Green.
- 36" Enviro-Cones can be made with 10lb or 12lb bases; 1 4", 1 6", 1 4" & 6", or no reflective collars.

18" Enviro-Cone		
18" Enviro-Cone, 3LB. - Complete		
16018-NSWB-3	18" Cone, No Collars	\$10.90
16018-HIWB-3	18" Cone w/(1) 6" Reflective Collar	\$15.6
28" Enviro-Cone		
28" Enviro-Cone, 7 LB. - Complete		
16028-NSWB-7	28" Cone, No Collars	\$16.60
16028-HI4WB-7	28" Cone w/(1) 4" Reflective Collar (ON)	\$18.10
16028-HI6WB-7	28" Cone w/(1) 6" Reflective Collar	\$21.60
16028-HIWB-7	28" Cone w/(1) 6" & (1) 4" Reflective Collars	\$23.90
28" Enviro-Cone, 10 LB. - Complete		
16028-NSWB-10	28" Cone, No Collars	\$21.30
16028-HI4WB-10	28" Cone w/(1) 4" Reflective Collar (ON)	\$22.10
16028-HI6WB-10	28" Cone w/(1) 6" Reflective Collar	\$24.40
16028-HIWB-10	28" Cone w/(1) 6" & (1) 4" Reflective Collars	\$27.80
28" Enviro-Cone, 12 LB. - Complete		
16028-NSWB-12	28" Cone, No Collars	\$24.20
16028-HI4WB-12	28" Cone w/(1) 4" Reflective Collar (ON)	\$24.90
16028-HI6WB-12	28" Cone w/(1) 6" Reflective Collar	\$28.00
16028-HIWB-12	28" Cone w/(1) 6" & (1) 4" Reflective Collars	\$29.20
36" Enviro-Cone		
36" Enviro-Cone, 10 LB. - Complete		
16036-NSWB-10	36" Cone, No Collars	\$22.70
16036-HI6WB-10	36" Cone w/(1) 6" Reflective Collar	\$28.20
16036-HIWB-10	36" Cone w/(1) 6" & (1) 4" Reflective Collars	\$29.50
36" Enviro-Cone, 12 LB. - Complete		
16036-NSWB-12	36" Cone, No Collars	\$25.10
16036-HI6WB-12	36" Cone w/(1) 6" Reflective Collar	\$29.50
16036-HIWB-12	36" Cone w/(1) 6" & (1) 4" Reflective Collars	\$30.00

• For Lime Color, add \$1.00 to above Prices and a -L to the middle of the Stock Number. Example: 16028-L-HIWB-7

Color Traffic Cones



**28" Orange Traffic Cone Black Base
2 Collars**



**28" Yellow Traffic Cone Black Base
2 Collars**



**28" Blue Traffic Cone Black Base
2 Collars**



**28" White Traffic Cone Black Base
2 Collars**

03-500-07	DW Traffic Cone 28" Orange 7#	\$23.00
03-500-64	DW Traffic Cone 28" Blue 7#	\$39.00
03-500-66	DW Traffic Cone 28" White 7#	\$39.00
03-500-67	DW Traffic Cone 28" Yellow 7#	\$39.00
03-500-10	DW Traffic Cone 28" Orange 7# 6 3/4" Collars	\$32.50
03-500-69	DW Traffic Cone 28" Blue 7# 6 3/4" Collars	\$43.50
03-500-75	DW Traffic Cone 28" Yellow 7# 6 3/4" Collars	\$43.50
03-500-77	DW Traffic Cone 28" White 7# 6 3/4" Collars	\$43.50



28" Spring Cones in the Cones Steel Tote

5 Spring Cones & Industrial Tote System

Q5N50-28R	(5) 28" Reflective (6" & 4") 3# Spring Cones & (1) Tote	\$234.90
-----------	---	----------

10 Spring Cones w/Locking Metal Box System

Q10LB100-28R	(10) 28" Reflective (6" & 4") 3# Spring Cones & (1) Tote	\$678.00
--------------	--	----------

Call to Order **516-825-0727**
Or Visit Us On-Line
Parkingproshop.com
Bulk Pricing Available



Stacker Round Top Channelizer Cone



42" Round-Top Orange Cone



42" Round-Top Blue Cone



42" Round-Top Yellow Cone



42" Round-Top Lime Cone



10 Lbs Recycled Hexagon Rubber Base

03-770-36-P	36" Round-Top Orange Cone - No Collars	3 lbs.	\$21.00
03-770-36-64OW	36" Round-Top Orange Cone - 6"/4" Collars	3 lbs.	\$33.50
03-770-36B-P	36" Round-Top Blue Cone - No Collars	3 lbs.	\$28.00
03-770-36B64	36" Round-Top Blue Cone - 6"/4" Collars	3 lbs.	\$45.00
03-770-36Y-P	36" Round-Top Yellow Cone - No Collars	3 lbs.	\$28.00
03-770-36Y64	36" Round-Top Yellow Cone - 6"/4" Collars	3 lbs.	\$45.00
03-770-36L-P	36" Round-Top Lime Cone - No Collars	3 lbs.	\$28.00
03-770-36L64	36" Round-Top Lime Cone - 6"/4" Collars	3 lbs.	\$49.50
03-770-42-P	42" Round-Top Orange Cone - No Collars	4 lbs.	\$25.00
03-770-42-64OW	42" Round-Top Orange Cone - 6"/4" Collars	4 lbs.	\$40.00
03-770-42B-P	42" Round-Top Blue Cone - No Collars	4 lbs.	\$31.00
03-770-42B64	42" Round-Top Blue Cone - 6"/4" Collars	4 lbs.	\$45.00
03-770-42Y-P	42" Round-Top Yellow Cone - No Collars	4 lbs.	\$31.00
03-770-42Y64	42" Round-Top Yellow Cone - 6"/4" Collars	4 lbs.	\$45.00
03-770-42L-P	42" Round-Top Lime Cone - No Collars	4 lbs.	\$31.00
03-770-42L64	42" Round-Top Lime Cone - 6"/4" Collars	4 lbs.	\$38.00
03-770-5	Recycled Hexagon Rubber Base - 10 lbs.	10 lbs.	\$25.00
03-770-6	Recycled Hexagon Rubber Base - 15 lbs.	15 lbs.	\$27.50

Looper delineators



42" Orange Looper® Tube with 8# Rubber Base

46000-TRU8	10 lbs.	Non-Reflective	\$20.20
46133-TRU8HIP	10 lbs.	With (2) 3" Bands of HIP Reflective Tape	\$23.30
46144-TRU8HIP	10 lbs.	With (2) 4" Bands of HIP Reflective Tape	\$23.70
46133-TRU8DG	10 lbs.	With (2) 3" Bands of DG Reflective Tape	\$28.30
46144-TRU8DG	10 lbs.	With (2) 4" Bands of DG Reflective Tape	\$29.60

42" Orange Looper® Tube with 12# Rubber Base

46000-TRU12	14 lbs.	Non-Reflective	\$24.00
46133-TRU12HIP	14 lbs.	With (2) 3" Bands of HIP Reflective Tape	\$26.60
46144-TRU12HIP	14 lbs.	With (2) 4" Bands of HIP Reflective Tape	\$28.10
46133-TRU12DG	14 lbs.	With (2) 3" Bands of DG Reflective Tape	\$28.80
46144-TRU12DG	14 lbs.	With (2) 4" Bands of DG Reflective Tape	\$29.80

42" Orange Looper® Tube with 18# Rubber Base

46000-TRU18	20 lbs.	Non-Reflective	\$29.70
46133-TRU18HIP	20 lbs.	With (2) 3" Bands of HIP Reflective Tape	\$32.70
46144-TRU18HIP	20 lbs.	With (2) 4" Bands of HIP Reflective Tape	\$34.20
46133-TRU18DG	20 lbs.	With (2) 3" Bands of DG Reflective Tape	\$36.20
46144-TRU18DG	20 lbs.	With (2) 4" Bands of DG Reflective Tape	\$36.80

42" Orange Looper® Tube, Stem Only (No Base)

46000-TSO	2 lbs.	Non-Reflective	\$12.70
46133-TSO-HIP	2 lbs.	With (2) 3" Bands of HIP Reflective Tape	\$17.80
46144-TSO-HIP	2 lbs.	With (2) 4" Bands of HIP Reflective Tape	\$19.20
46133-TSO-DG	2 lbs.	With (2) 3" Bands of DG Reflective Tape	\$22.50
46144-TSO-DG	2 lbs.	With (2) 4" Bands of DG Reflective Tape	\$23.30

- For Colored Tubes (Black, White, Yellow & Lime) add \$1.00 to above price and change part number. See below
- For BLACK Looper Tube, change TRU or TSO to "TRB or TSB" in part number. Ex. 46133-TRB12HIP
- For WHITE Looper Tube, change TRU or TSO to "TRW or TSW" in part number. Ex. 46133-TRW18HIP
- For YELLOW Looper Tube, change TRU or TSO to "TRY or TSY" in part number. Ex. 46133-TSYHIP
- For LIME Looper Tube, change TRU or TSO to "TRL or TSL" in part number. Ex. 46133-TSLHIP

Tube Base Only, Recycled Rubber

42000-TB8	8 lbs.	8# Tube Base	\$13.00
42000-TB12	12 lbs.	12# Tube Base	\$16.30
42000-TB18	18 lbs.	18# Tube Base	\$22.40

Call to Order **516-825-0727**
 Or Visit Us On-Line
Parkingproshop.com
 Bulk Pricing Available



Ez Grab Delineator

EZ GRAB DELINEATOR PERMANENT



EZ GRAB DELINEATOR PERMANENT MOUNT - BOXED KITS



03-735	3 lbs.	41" EZ Grab Straight Orange Post - (2)4" High Intensity Prismatic Collars	\$25.00
03-735B	3 lbs.	41" EZ Grab Straight Blue Post - (2)4" High Intensity Prismatic Collars	\$28.00
03-735Y	3 lbs.	41" EZ Grab Straight Yellow Post - (2)4" High Intensity Prismatic Collars	\$28.00
03-735FG	3 lbs.	41" EZ Grab Straight Forest Green Post - (2)4" High Intensity Prismatic Collars	\$28.00
03-735LI	3 lbs.	41" EZ Grab Straight Lime Post - (2)4" High Intensity Prismatic Collars	\$28.00
03-735W	3 lbs.	41" EZ Grab Straight White Post - (2)4" High Intensity Prismatic Collars	\$28.00
03-733-1	2 lbs.	Fiberglass Reinforced 8" Diameter Plastic Base w/channel clamp	\$25.00

EZ GRAB DELINEATOR PERMANENT MOUNT - BOXED KITS

03-746ABC	5 lbs.	41" EZ Grab Straight Orange Post - (2)4" HIP Collars & Base w/Clamp	\$52.00
03-746BABC	5 lbs.	41" EZ Grab Straight Blue Post - (2)4" HIP Collars & Base w/Clamp	\$55.00
03-746YABC	5 lbs.	41" EZ Grab Straight Yellow Post - (2)4" HIP Collars & Base w/Clamp	\$55.00
03-746FGABC	5 lbs.	41" EZ Grab Straight Forest Green Post - (2)4" HIP Collars & Base w/Clamp	\$55.00
03-746LIABC	5 lbs.	41" EZ Grab Straight Lime Post - (2)4" HIP Collars & Base w/Clamp	\$55.00
03-746RABC	5 lbs.	41" EZ Grab Straight Red Post - (2)4" HIP Collars & Base w/Clamp	\$55.00
03-746WABC	5 lbs.	41" EZ Grab Straight White Post - (2)4" HIP Collars & Base w/Clamp	\$55.00

EZ GRAB DELINEATOR PORTABLE



03-740	3 lbs.	45" EZ Grab Flared Orange Post - No Collars	\$20.50
03-734	3 lbs.	45" EZ Grab Flared Orange Post - (2)3" High Intensity Prismatic Collars	\$28.00
03-737	3 lbs.	45" EZ Grab Flared Orange Post - (2)3" HIP Collars w/(2) Amber Reflectors	\$41.50
03-747	3 lbs.	45" EZ Grab Flared Orange Post - (2)4" High Intensity Prismatic Collars	\$32.00
03-740B	3 lbs.	45" EZ Grab Flared Blue Post - No Collars	\$22.50
03-747B	3 lbs.	45" EZ Grab Flared Blue Post - (2)3" High Intensity Prismatic Collars	\$42.00
03-740Y	3 lbs.	45" EZ Grab Flared Yellow Post - No Collars	\$22.50
03-747Y	3 lbs.	45" EZ Grab Flared Yellow Post - (2)3" High Intensity Prismatic Collars	\$37.00
03-740FG	3 lbs.	45" EZ Grab Flared Forest Green Post - No Collars	\$22.50
03-747FG	3 lbs.	45" EZ Grab Flared Forest Green Post - (2)3" High Intensity Prismatic Collars	\$42.00
03-740LI	3 lbs.	45" EZ Grab Flared Lime Post - No Collars	\$22.50
03-747LI	3 lbs..	45" EZ Grab Flared Lime Post - (2)3" High Intensity Prismatic Collars	\$34.00
03-740R	3 lbs.	45" EZ Grab Flared Red Post - No Collars	\$22.50
03-747R	3 lbs.	45" EZ Grab Flared Red Post - (2) 3" Reflective Collars	\$34.00
03-740W	3 lbs.	45" EZ Grab Flared White Post - No Collars	\$22.50
03-747W	3 lbs.	45" EZ Grab Flared White Post - (2)3" High Intensity Prismatic Collars	\$42.00
3-740BLK	3 lbs.	45" EZ Grab Flared Black Post - No Collars	\$22.50
03-747BLK	3 lbs.	45" EZ Grab Flared Black Post - (2)3" High Intensity Prismatic Collars	\$42.00

EZ GRAB BASE OPTIONS

03-730	10 lbs.	Recycled Square Rubber Base - 10 lbs.	\$16.00
03-731	15 lbs.	Recycled Hexagon Rubber Base - 15 lbs.	\$25.00



03-729-5	25 lbs.	EZ Grab 5 Orange Post Curb Base System (includes: 5 ea. 03-734 and base)	\$192.38
----------	---------	--	----------



03-824CBKT	32 lbs.	EZ Grab Cone Bar System Includes: (2) 45" EZ Grab Flared Orange Post - (2)3" HIP Collars, (2) Square Rubber 10 lb. Bases and Cone Bar, Retractable 5'-9' Orange w/(3) 4" HI Collars (5" dia. ring)	\$142.65
------------	---------	--	----------

Plastic Chains

• Plastic Chain

Highest-quality plastic chain made in the US direct from the manufacturer. Choose from endless combinations of styles, colors and sizes.



	Chain	Feet	
1-100	3/4"	100	\$66.99
10001-100	1"	100	\$70.99
30001-100	1.5"	100	\$79.99
50001-100	2"	100	\$93.99
51001-100	2" HD	100	\$100.99
80001-100	3"	100	\$138.99

	Chain	Feet	
00101	3/4"	200	\$142.99
10101	1"	250	\$190.99
30101	1.5"	200	\$160.99
50101	2"	125	\$115.99
51101	2" HD	100	\$100.99
80100	3"	60	\$82.99

	Chain	Feet	
10001	1"	350	\$258.99
30001	1.5"	300	\$238.99
50001	2"	160	\$150.99
51001	2" HD	120	\$118.99
80001	3"	70	\$94.99

• Accessories

From plastic s-hook chain connectors to plastic stanchion c-hooks and o-rings, and 1"-2" clips to magnet ring/carabiner kits, we have the plastic chain and stanchion accessories to fit your needs.



Master Link			
00701-10	3/4"	10 Units	\$3.60
10701-10	1"	10 Units	\$4.40
30701-10	1.5"	10 Units	\$5.00
50701-10	2"	10 Units	\$5.80
51701-10	2" HD	10 Units	\$6.90
80701-10	3"	10 Units	\$12.90

S Hook			
00301-10	3/4"	10 Units	\$3.60
10301-10	1"	10 Units	\$4.40
30301-10	1.5"	10 Units	\$5.00
50301-10	2"	10 Units	\$5.80
80301-10	3"	10 Units	\$12.90

Connect all Straps				
97603-S	Small	Black	\$8.99	Unit
97603-L	Large	Black	\$9.99	Unit

Call to Order **516-825-0727**
 Or Visit Us On-Line
Parkingproshop.com
 Bulk Pricing Available



Parking Meter Hoods



Custom Cloth Meter Hoods

- Grommets
- Durable and weather resistant
- Made of 600 Denier Polyester - Sunbrella is a top of the line fabric in fade resistance from the sun and or staining
- Available in: ■ ■ ■ ■ ■ ■

Single

1-100	\$26.00	ea
101-199	\$24.50	ea
200+	\$21.99	ea

Screen manufacturing fee \$50
Screened add' \$1 per unit



Custom PVC Meter Hoods

- NO PARKING printed on both sides with grommets
- Custom marking available

Available sizes:

- Single Hood - 12"W x 20"H
- Double Hood - 21"W x 25"H

Single

1-100	\$14.00	ea
101-199	\$13.80	ea
200+	\$12.99	ea

Screen manufacturing fee \$50
Screened add' \$1 per unit

Tickets



Standard Tickets

Hanging Tickets

CALL FOR PRICING

CALL FOR PRICING

- 110lb paper
- All custom sizes available
- Logo and other custom design included
- Barcode available



White

Yellow

Blue

Green



Manilla Salmon Gray

Call to Order **516-825-0727**
 Or Visit Us On-Line
Parkingproshop.com
 Bulk Pricing Available



5-CHANNEL HEAVY DUTY LINEBACKER®

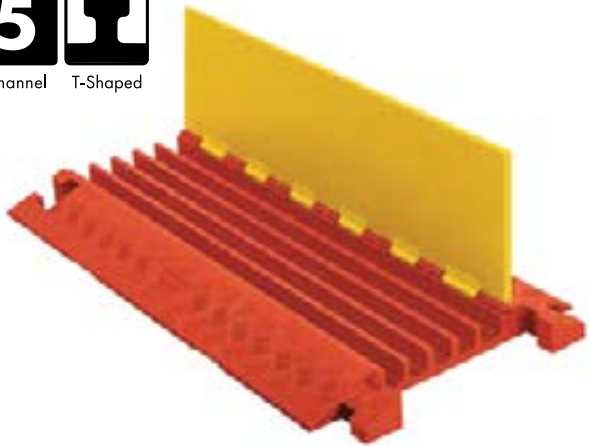

MODEL: CP5X125-YO

5-CHANNEL HEAVY DUTY LINEBACKER®

- HUV-stabilized polyurethane material
- Protects cables and hoses up to 1.35 in. outside dia.
- Patented T-Connectors to extend to any length
- Patented 5-bar tread surface for maximum traction
- Reinforced hinged lid for easy cable placement
- Easy to transport, setup, disassemble and store



MODEL: CPT5X125-L-YO MODEL: CPT5X125-R-YO MODEL: CPEC5X125-0

ACCESSIBILITY RAMPS AND RAILS

for 5-Channel Heavy Duty Linebacker®



RAILS MODEL: CPRL-4/5 RAMPS MODEL: CPRP-4/5

PROTECTOR BRIDGES

for 5-Channel Heavy Duty Linebacker®

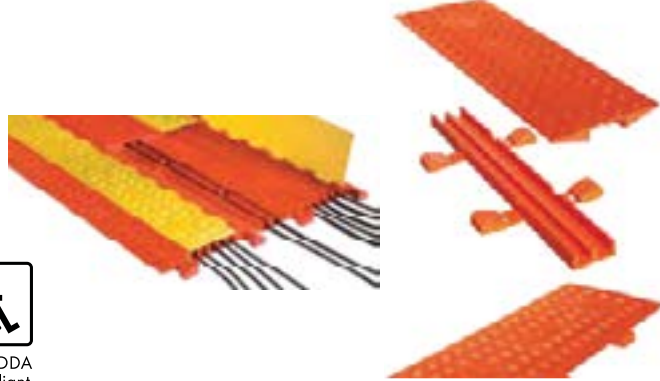

MODEL: CL2X150-4/5-0



Model	Description	Length	Width	Height	Channel Width	Maximum OD	Weight	Prop 65
CP5X125-YO	5-CH LB HD	36 in. (91.4 cm)	20 in. (50.8 cm)	2.31 in. (5.72 cm)	1.35 in. (3.43 cm)	1.35 in. (3.43 cm)	25 lb. (11.3 kg)	⚠
CPT5X125-L-YO	45° Left Turn	25 in. (63.5 cm)	20 in. (50.8 cm)	2.31 in. (5.72 cm)	1.35 in. (3.43 cm)	1.35 in. (3.43 cm)	13 lb. (5.9 kg)	⚠
CPT5X125-R-YO	45° Right Turn	25 in. (63.5 cm)	20 in. (50.8 cm)	2.31 in. (5.72 cm)	1.35 in. (3.43 cm)	1.35 in. (3.43 cm)	13 lb. (5.9 kg)	⚠
CPEC5X125-0	End Caps (Pair Only)	F: 7.5 in. (19 cm) M: 5.25 in. (13.3 cm)	20 in. (50.8 cm) 20 in. (50.8 cm)	2.31 in. (5.72 cm) 2.31 in. (5.72 cm)	1.35 in. (3.43 cm) 1.35 in. (3.43 cm)	1.35 in. (3.43 cm) 1.35 in. (3.43 cm)	3.5 lb. (1.6 kg) 3.5 lb. (1.6 kg)	⚠

Model	Description	Length	Width	Height	Weight	Prop 65
CPRP-4/5-BLU	Ramps Pair	36 in. (91.44 cm) (single)	21.88 in. (55.58 cm) (single)	2 in. (5.08 cm)	40 lb. (18.1 kg) (pair)	⚠
CPRL-4/5-Y	Rails Pair	1.5 in. (3.18 cm)	55.5 in. (140.97 cm)	2 in. (5.08 cm)	12.75 lb. (5.8 kg)	⚠

Model	Description	Length	Width	Height	Channel Width	Maximum OD	Weight	Prop 65
CL2X150-4/5-0	2-CH Protector Bridge for 5-CH LB HD	36 in. (91.44 cm)	14 in. (35.56 cm)	2.125 in. (5.3 cm)	1.5 in. (3.81 cm)	1.5 in. (3.81 cm)	18 lb. (8.2 kg)	⚠

⚠ WARNING: Cancer and Reproductive Harm - www.P65Warnings.ca.gov

4-CHANNEL HEAVY DUTY LINEBACKER®



4-CHANNEL HEAVY DUTY LINEBACKER®

- Protects cables and hoses up to 1.35 in. outside dia.
- Patented T-Connectors to extend to any length
- Patented 5-bar tread surface for maximum traction
- Reinforced hinged lid for easy cable placement
- All-weather polyurethane construction
- Easy to transport, setup, disassemble and store

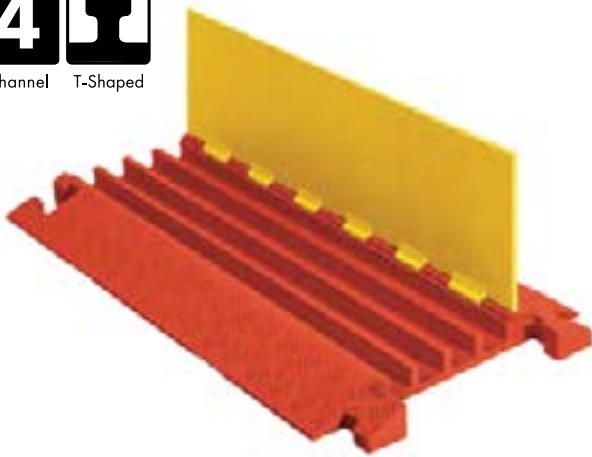

MODEL: CP4X125-YO

MODEL: CPT4X125-L-YO

MODEL: CPT4X125-R-YO

MODEL: CPEC4X125-O

ACCESSIBILITY RAMPS AND RAILS

for 4-Channel Heavy Duty Linebacker®



RAILS MODEL: CPRL-4/5-BLU

RAMPS MODEL: CPRP-4/5-Y



ADA/DDA
Compliant

PROTECTOR BRIDGES

for 4-Channel Heavy Duty Linebacker®

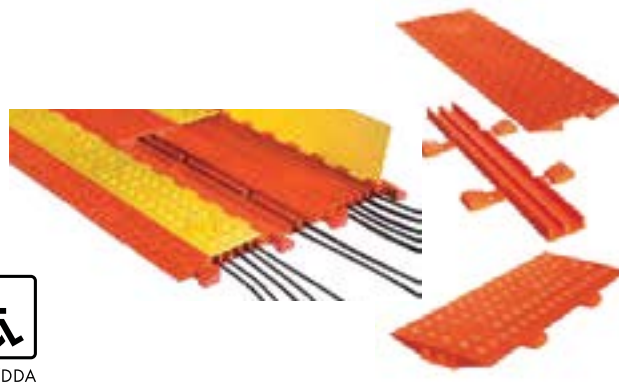

MODEL: CL2X150-4/5-O



Model	Description	Length	Width	Height	Channel Width	Maximum OD	Weight	Prop 65
CP4X125-YO	4-CH LB HD	36 in. (91.4 cm)	20 in. (50.8 cm)	2.31 in. (5.72 cm)	1.85 in. (4.71 cm)	1.35 in. (3.43 cm)	26 lb. (11.8 kg)	⚠
CPT4X125-L-YO	45° Left Turn	25 in. (63.5 cm)	20 in. (50.8 cm)	2.31 in. (5.72 cm)	1.85 in. (4.71 cm)	1.35 in. (3.43 cm)	13 lb. (5.9 kg)	⚠
CPT4X125-R-YO	45° Right Turn	25 in. (63.5 cm)	20 in. (50.8 cm)	2.31 in. (5.72 cm)	1.85 in. (4.71 cm)	1.35 in. (3.43 cm)	13 lb. (5.9 kg)	⚠
CPEC4X125-O	End Caps (Pair Only)	F: 7.5 in. (19 cm)	20 in. (50.8 cm)	2.31 in. (5.72 cm)	1.85 in. (4.71 cm)	1.35 in. (3.43 cm)	3.5 lb. (1.6 kg)	⚠
		M: 5.25 in. (13.3 cm)	20 in. (50.8 cm)	2.31 in. (5.72 cm)	1.85 in. (4.71 cm)	1.35 in. (3.43 cm)	3.5 lb. (1.6 kg)	

Model	Description	Length	Width	Height	Weight	Prop 65
CPRP-4/5-BLU	Ramps Pair	36 in. (91.44 cm) (single)	21.88 in. (55.58 cm) (single)	2 in. (5.08 cm)	40 lb. (18.1 kg) (pair)	⚠
CPRL-4/5-Y	Rails Pair	1.5 in. (3.18 cm)	55.5 in. (140.97 cm)	2 in. (5.08 cm)	12.75 lb. (5.8 kg)	⚠

Model	Description	Length	Width	Height	Channel Width	Maximum OD	Weight	Prop 65
CL2X150-4/5-O	2-CH Protector Bridge for 5-CH LB HD	36 in. (91.44 cm)	14 in. (35.56 cm)	2.125 in. (5.3 cm)	1.5 in. (3.81 cm)	1.5 in. (3.81 cm)	18 lb. (8.2 kg)	⚠

⚠ WARNING: Cancer and Reproductive Harm - www.P65Warnings.ca.gov

Call to Order **516-825-0727**
Or Visit Us On-Line
Parkingproshop.com
Bulk Pricing Available



3-CHANNEL HEAVY DUTY LINEBACKER®

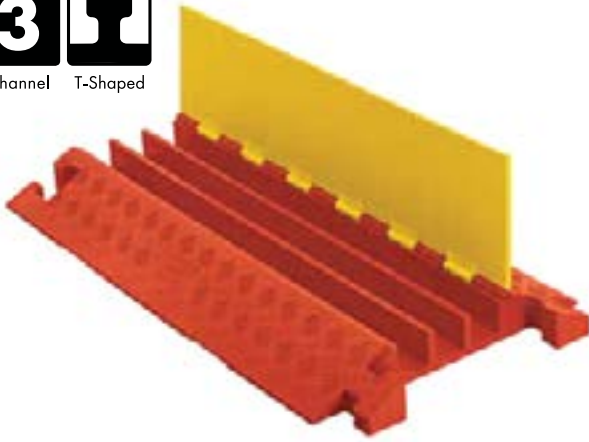

MODEL: CP3X225-YO

3-CHANNEL HEAVY DUTY LINEBACKER®

- Protects cables and hoses up to 2.25 in. outside dia.
- Patented T-Connectors to extend to any length
- Reinforced hinged lid for easy cable placement
- All-weather polyurethane construction
- Patented 5-bar tread surface for maximum traction
- Easy to transport, setup, disassemble and store



MODEL: CPT3X225-L-YO

MODEL: CPT3X225-R-YO

MODEL: CPEC3X225-O

ACCESSIBILITY RAMPS AND RAILS

for 3-Channel Heavy Duty Linebacker®

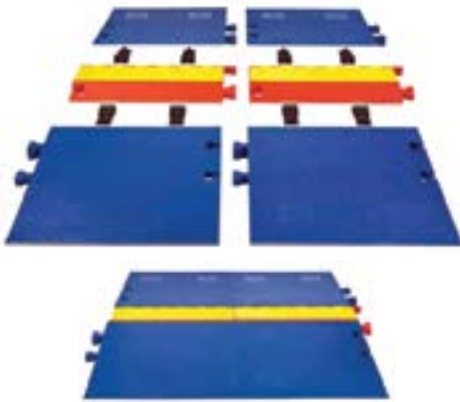

MODEL: CPRP-3-BLU



Model	Description	Length	Width	Height	Channel Width	Maximum OD	Weight	Prop 65
CP3X225-YO	3-CH LB HD	36 in. (91.4 cm)	20 in. (50.8 cm)	3.05 in. (7.75 cm)	2.25 in. (5.72 cm)	2.25 in. (5.72 cm)	28 lb. (12.7 kg)	⚠
CPT3X225-L-YO	45° Left Turn	25 in. (63.5 cm)	20 in. (50.8 cm)	3.05 in. (7.75 cm)	2.25 in. (5.72 cm)	2.25 in. (5.72 cm)	15 lb. (6.8 kg)	⚠
CPT3X225-R-YO	45° Right Turn	25 in. (63.5 cm)	20 in. (50.8 cm)	3.05 in. (7.75 cm)	2.25 in. (5.72 cm)	2.25 in. (5.72 cm)	15 lb. (6.8 kg)	⚠
CPEC3X225-O	End Caps (Pair Only)	F: 8.25 in. (20.96 cm)	20 in. (50.8 cm)	3.05 in. (7.75 cm)	2.25 in. (5.72 cm)	2.25 in. (5.72 cm)	4 lb. (1.8 kg)	⚠
		M: 6 in. (15.24 cm)	20 in. (50.8 cm)	3.05 in. (7.75 cm)	2.25 in. (5.72 cm)	2.25 in. (5.72 cm)	4 lb. (1.8 kg)	

Model	Length	Width	Height	Weight	Prop 65
CPRP-3-BLU (Includes 2 ramps & 4 connectors)	36 in. (91.44 cm)	34.81 in. (88.42 cm)	2.88 in. (7.32 cm)	66 lb. (30 kg)	⚠

⚠ WARNING: Cancer and Reproductive Harm - www.P65Warnings.ca.gov

2-CHANNEL HEAVY DUTY LINEBACKER®

4-CHANNEL GENERAL MANUFACTURING LINEBACKER®



Channel T-Shaped

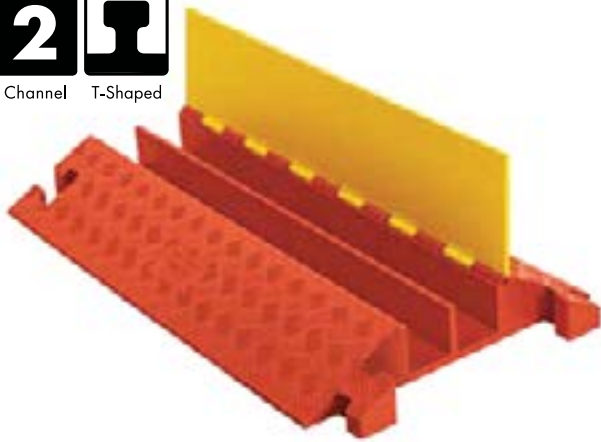

MODEL: CP2X325-YO

2-CHANNEL HEAVY DUTY LINEBACKER®

- Protects cables and hoses up to 3.25 in. outside dia.
- Patented T-Connectors to extend to any length
- Reinforced hinged lid for easy cable placement
- All-weather polyurethane construction
- Patented 5-bar tread surface for maximum traction
- Easy to transport, setup, disassemble and store



Model	Description	Length	Width	Height	Channel Width	Maximum OD	Weight	Prop 65
CP2X325-YO	2-CH HD LB	36 in. (91.4 cm)	22 in. (55.88 cm)	4.13 in. (10.16 cm)	3.25 in. (8.26 cm)	3.25 in. (8.26 cm)	33 lb. (15.0 kg)	⚠



Channel T-Shaped

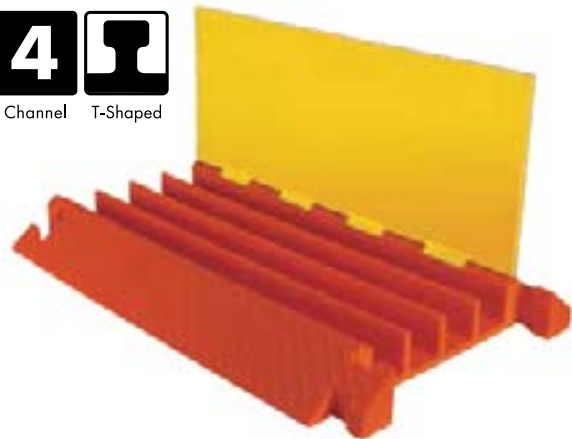

MODEL: CP4X300-YO

4-CHANNEL GENERAL MANUFACTURING LINEBACKER®

- Protects cables and hoses up to 3 in. outside dia.
- Designed for manufacturing facilities
- Patented T-Connectors to extend to any length
- Thick lid and base allow for high volume of traffic
- Reinforced hinged lid for easy cable placement
- Modular interlocking design



MODEL: CPY4X300-YO

MODEL: CPCR4X300-YO

MODEL: CPEC4X300-O



Model	Description	Length	Width	Height	Channel Width	Maximum OD	Weight	Prop 65
CP4X300-YO	4-CH Gen. Manf. LB	36 in. (91.4 cm)	23.875 in. (60.64 cm)	3.875 in. (9.84 cm)	3 in. (7.62 cm)	3 in. (7.62 cm)	42.2 lb. (19.1 kg)	⚠
CPY4X300-YO	45° Y Connector	24 in. (60.96 cm)	24 in. (60.96 cm)	3.875 in. (9.84 cm)	3 in. (7.62 cm)	3 in. (7.62 cm)	31.85 lb. (14.4 kg)	⚠
CPCR4X300-YO	90° 4-Way Cross	25.5 in. (64.77 cm)	24 in. (60.96 cm)	4 in. (10.16 cm)	3 in. (7.62 cm)	3 in. (7.62 cm)	38.05 lb. (17.3 kg)	⚠
CPEC4X300-O	End Caps (Pair Only)	F: 6.75 in. (17.15 cm) M: 6.75 in. (17.15 cm)	23.875 in. (60.64 cm) 23.875 in. (60.64 cm)	3.5 in. (8.89 cm) 3.5 in. (8.89 cm)	3 in. (7.62 cm) 3 in. (7.62 cm)	3 in. (7.62 cm) 3 in. (7.62 cm)	6.3 lb. (2.9 kg) 9.45 lb. (4.3 kg)	⚠

⚠ WARNING: Cancer and Reproductive Harm - www.P65Warnings.ca.gov

Call to Order **516-825-0727**
 Or Visit Us On-Line
Parkingproshop.com
 Bulk Pricing Available



5-CHANNEL GENERAL PURPOSE LINEBACKER®

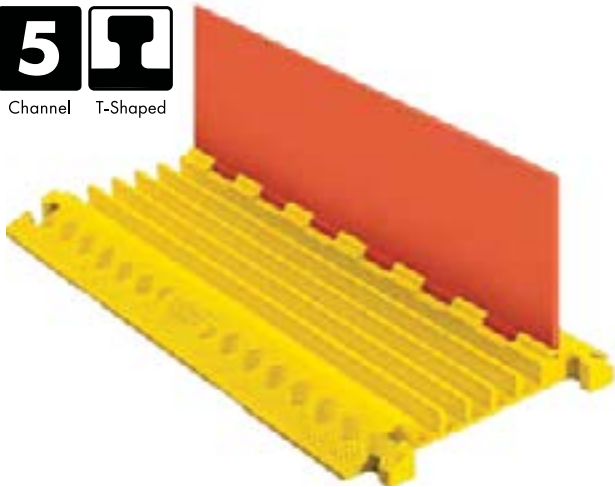

MODEL: CP5X125-GP-OY

5-CHANNEL GENERAL PURPOSE LINEBACKER®

- Protects cables and hoses up to 1.3 in. outside dia.
- Patented T-Connectors to extend to any length
- Reinforced hinged lid for easy cable placement
- All-weather polyurethane construction
- Patented 5-bar tread surface for maximum traction
- Easy to transport, setup, disassemble and store



MODEL: CPY5X125-GP-OY



MODEL: CPEC5X125-GP-O



ACCESSIBILITY RAMPS AND RAILS for 5-Channel General Purpose Linebacker®



RAILS MODEL: CPRL-5GP-BLU RAMP MODEL: CPRP-5GP-Y



ADA/DDA Compliant

PROTECTOR BRIDGES for 5-Channel General Purpose Linebacker®

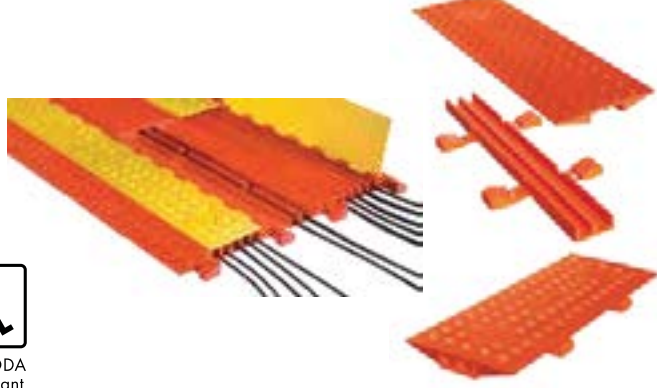

MODEL: CL2X150-4/5-O



Model	Description	Length	Width	Height	Channel Width	Maximum OD	Weight	Prop 65
CP5X125-GP-OY	5-CH GP LB	36 in. (91.44 cm)	17.25 in. (43.82 cm)	1.95 in. (5.0 cm)	1.3 in. (3.3 cm)	1.3 in. (3.3 cm)	22 lb. (10 kg)	⚠
CPEC5X125-GP-OY	45° Right Turn	19.75 in. (50.17 cm)	17.25 in. (43.82 cm)	1.95 in. (5.0 cm)	1.3 in. (3.3 cm)	1.3 in. (3.3 cm)	9.4 lb. (4.3 kg)	⚠
CPEC5X125-GP-O	End Caps (Pair Only)	F: 4.75 in. (12.07 cm)	17.25 in. (43.82 cm)	1.95 in. (5.0 cm)	1.3 in. (3.3 cm)	1.3 in. (3.3 cm)	2.7 lb. (1.2 kg)	⚠
		F: 4.75 in. (12.07 cm)	17.25 in. (43.82 cm)	1.95 in. (5.0 cm)	1.3 in. (3.3 cm)	1.3 in. (3.3 cm)	2.7 lb. (1.2 kg)	

Model	Description	Length	Width	Height	Weight	Prop 65
CPRP-5GP-BLU	Ramps Pair	36 in. (91.44 cm) (single)	21.88 in. (55.58 cm) (single)	2 in. (5.08 cm)	40 lb. (18.1 kg) (pair)	⚠
CPRL-5GP-Y	Rails Pair	1.5 in. (3.18 cm)	54 in. (137.16 cm)	2 in. (5.08 cm)	12.75 lb. (5.8 kg)	⚠

Model	Description	Length	Width	Height	Channel Width	Maximum OD	Weight	Prop 65
CL2X150-GP-O	2-CH Protector Bridge for 5-CH GP LB	36 in. (91.44 cm)	12.5 in. (21.6 cm)	1.875 in. (4.76 cm)	1.5 in. (3.81 cm)	1.5 in. (3.81 cm)	14 lb. (6.4 kg)	⚠

⚠ WARNING: Cancer and Reproductive Harm - www.P65Warnings.ca.gov

1-CHANNEL GENERAL PURPOSE LINEBACKER®

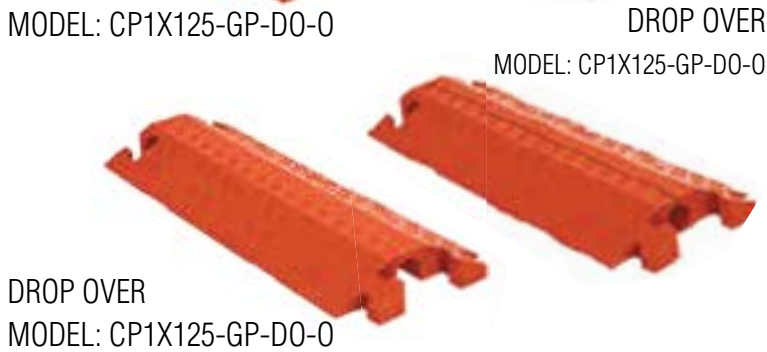
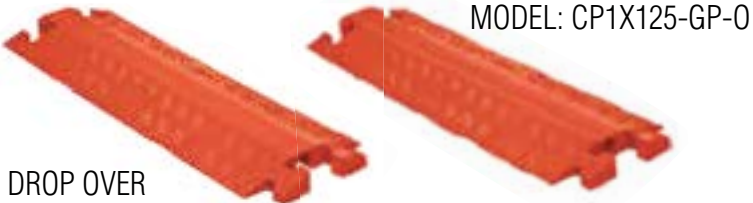

1-CHANNEL GENERAL PURPOSE LINEBACKER®

- Protects cables and hoses up to 2.25 in. outside dia.
- Patented T-Connectors to extend to any length
- Drop Over or Split Top models available
- All-weather polyurethane construction
- Modular interlocking design is lightweight and easy to transport, setup, disassemble and store

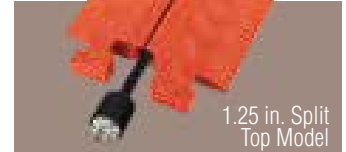

1.25 INCH SINGLE CHANNEL SPECIFICATIONS

Model	Description	Length	Width	Height	Maximum OD	Weight	Prop 65
CP1X125-GP*	1.25 in. 1-CH GP Split Top CP	36 in. (91.44 cm)	11.5 in. (29.21 cm)	1.6 in. (4.06 cm)	1.25 in. (3.18 cm)	13 lb. (5.9 kg)	⚠
CP1X125-GP-D0*	1.25 in. 1-CH GP Drop Over CP	36 in. (91.44 cm)	11.5 in. (29.21 cm)	1.6 in. (4.06 cm)	1.25 in. (3.18 cm)	13 lb. (5.9 kg)	⚠

2.25 INCH SINGLE CHANNEL SPECIFICATIONS

Model	Description	Length	Width	Height	Maximum OD	Weight	Prop 65
CP1X225-GP*	2.25 in. 1-CH GP Split Top CP	36 in. (91.44 cm)	14.25 in. (36.19 cm)	3 in. (7.62 cm)	2.25 in. (5.72 cm)	24 lb. (10.9 kg)	⚠
CP1X225-GP-D0*	2.25 in. 1-CH GP Drop Over CP	36 in. (91.44 cm)	14.25 in. (36.19 cm)	3 in. (7.62 cm)	2.25 in. (5.72 cm)	24 lb. (10.9 kg)	⚠

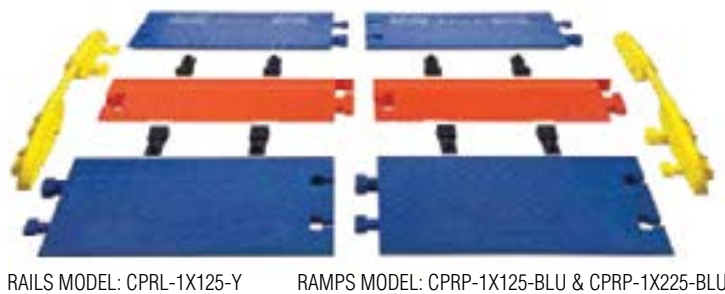

Model	Description	Length	Width	Height	Weight	Prop 65
CPRP-1X125-BLU	Ramps Pair (for 1 Channel 1.25 in. max OD)	36 in. (91.44 cm) (single)	21.88 in. (55.58 cm) (single)	2 in. (5.08 cm)	40 lb. (18.1 kg) (pair)	⚠
CPRL-1X125-Y	Rails Pair	1.5 in. (3.81 cm)	47 in. (119.38 cm)	2 in. (5.08 cm)	12.7 lb. (5.8 kg)	⚠
CPRP-1X225-BLU	Ramps Pair (for 1 Channel 2.25 in. max OD)	36 in. (91.44 cm) (single)	34.81 in. (88.42 cm) (single)	2.88 in. (7.32 cm)	66 lb. (30 kg) (pair)	⚠

⚠ WARNING: Cancer and Reproductive Harm - www.P65Warnings.ca.gov

Call to Order **516-825-0727**
Or Visit Us On-Line
Parkingproshop.com
Bulk Pricing Available



5-CHANNEL HEAVY DUTY YELLOW JACKET®



5-CHANNEL HEAVY DUTY YELLOW JACKET®

- Protects cables and hoses up to 1.25 in. outside dia.
- The “original” cable protector
- Dog Bone Connectors to extend to any desired length
- Thick lid and base allow for high volume of traffic
- Hinged lid for easy cable placement
- Modular interlocking design



MODEL: YJ5-125-YB

MODEL: YJ5TL-125-YB

MODEL: YJ5TR-125-YB

MODEL: YJ5EB-125-Y

MODEL: YJ5X-125-YB

AMS® ACCESSIBILITY RAMPS AND RAILS

for 5-Channel Heavy Duty Yellow Jacket®



AMS® ACCESSIBILITY RAMPS KITS

for 5-Channel Heavy Duty Yellow Jacket®

KIT 1

KIT 2

KIT 3



Hourglass®



Model	Description	Length	Width	Height	Channel Width	Maximum OD	Weight	Prop 65
YJ5-125-YB	5-CH HD YJ CP	36 in. (91.4 cm)	19.75 in. (50.2 cm)	1.875 in. (4.76 cm)	1.375 in. (3.49 cm)	1.25 in. (3.17 cm)	28.2 lb. (12.8 kg)	⚠
YJ5TL-125-YB	45° Left Turn	24 in. (61 cm)	19.75 in. (50.2 cm)	1.875 in. (4.76 cm)	1.25 in. (3.18 cm)	1.325 in. (3.37 cm)	14.2 lb. (6.4 kg)	⚠
YJ5TR-125-YB	45° Right Turn	24 in. (61 cm)	19.75 in. (50.2 cm)	1.875 in. (4.76 cm)	1.25 in. (3.18 cm)	1.325 in. (3.37 cm)	14.2 lb. (6.4 kg)	⚠
YJ5EB-125-Y	End Caps (Pair Only)	F: 7.375 in. (18.7 cm) M: 4.25 in. (10.8 cm)	19.75 in. (50.2 cm) 19.75 in. (50.2 cm)	1.875 in. (4.76 cm) 1.875 in. (4.76 cm)	1.25 in. (3.18 cm) 1.25 in. (3.18 cm)	1.125 in. (2.86 cm) 1.125 in. (2.86 cm)	4.05 lb. (1.8 kg) 3.45 lb. (1.6 kg)	⚠
YJ5X-125-YB	90° 4-Way Cross	W= 28.5 in. (72.4 cm) W2= 24.5 in. (62.2 cm)	19.75 in. (50.2 cm)	1.875 in. (4.76 cm)	1.339 in. (3.4 cm)	1.325 in. (3.37 cm)	23.1 lb. (10.5 kg)	⚠

Model	Description	Length	Width	Height	Weight	Prop 65
WSA-125-RFAH-Y	Female Ramp	36 in. (91.44 cm)	20.38 in. (51.75 cm)	1.875 in. (4.76 cm)	26 lb. (11.8 kg)	⚠
WSA-125-RMAH-Y	Male Ramp	36 in. (91.44 cm)	20 in. (50.8 cm)	1.875 in. (4.76 cm)	24.85 lb. (11.3 kg)	⚠
WSA-125-BFF-BLU	Side Ramps - Female Pair	17.75 in. (45.09 cm)	20.5 in. (52.07 cm)	1.875 in. (4.76 cm)	16.8 lb. (7.6 kg)	⚠
WSA-125-BFM-BLU	Side Ramps - Male Pair	17.75 in. (45.09 cm)	20.5 in. (52.07 cm)	1.875 in. (4.76 cm)	18.9 lb. (8.6 kg)	⚠
YJ5-125-AMS-CTR-YB	AMS® Center Section	36 in. (91.44 cm)	11.75 in. (29.85 cm)	1.875 in. (4.76 cm)	16.7 lb. (7.6 kg)	⚠
YJ5I-125-YB	Interconnect (Interconnects can connect to Guard Dog® or Yellow Jacket® 5-Channel)	17.88 in. (45.4 cm)	19.75 in. (50.17 cm)	1.875 in. (4.76 cm)	M: 16 lb. (7.3 kg) F: 15.6 lb. (7.1 kg)	⚠

Model	Description	Length	Width	Height	Weight	Prop 65
WSA-125-KIT1-HS	Dog Bone Connector	111.13 in. (228.3 cm)	51.25 in. (130.2 cm)	1.875 in. (4.76 cm)	151.5 lb. (68.7 kg)	⚠
WSA-125-KIT2-HS	Hourglass® Connector	75.38 in. (191.5 cm)	51.25 in. (130.2 cm)	1.875 in. (4.76 cm)	101 lb. (45.8 kg)	⚠
WSA-125-KIT3-HS	Hourglass® Connector	36 in. (91.44 cm)	51.25 in. (130.2 cm)	1.875 in. (4.76 cm)	67.5 lb. (30.6 kg)	⚠

⚠ WARNING: Cancer and Reproductive Harm - www.P65Warnings.ca.gov

5-CHANNEL HEAVY DUTY ADA/DDA YELLOW JACKET®

4-CHANNEL HEAVY DUTY YELLOW JACKET®

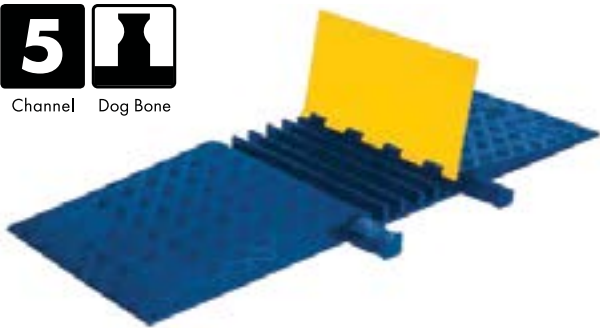

MODEL: YJ5-125-ADA-YBLU

5-CHANNEL HEAVY DUTY ADA/DDA YELLOW JACKET®

- Protects cables and hoses up to 1.325 in. outside dia.
- ADA/DDA accessibility ramps built in
- Interconnects directly to a Standard Ramp 5-Channel Yellow Jacket Cable Protector
- Dog Bone Connectors to extend to any desired length
- Reinforced hinged lid for easy cable placement



Model	Description	Length	Width	Height	Channel Width	Maximum OD	Weight	Prop 65
YJ5-125-ADA*	5-CH HD ADA YJ	18 in. (45.7 cm)	50.0 in. (127.0 cm)	1.875 in. (4.76 cm)	1.339 in. (3.4 cm)	1.325 in. (3.37 cm)	21 lb. (9.6 kg)	⚠



MODEL: YJ4-125-YB

4-CHANNEL HEAVY DUTY YELLOW JACKET®

- Protects cables and hoses up to 1.25 in. outside dia.
- The "original" cable protector
- Dog Bone Connectors to extend to any desired length
- Thick lid and base allow for high volume of traffic
- Hinged lid for easy cable placement
- Modular interlocking design



MODEL: YJ4EB-12-Y



Model	Description	Length	Width	Height	Channel Width	Maximum OD	Weight	Prop 65
YJ4-125-YB	4-CH HD YJ CP	36 in. (91.4 cm)	17.5 in. (44.45 cm)	2 in. (5.08 cm)	1.25 in. (3.18 cm)	1.25 in. (3.18 cm)	23.5 lb. (10.7 kg)	⚠
YJ4EB-125-Y	End Caps (Pair Only)	F: 7.25 in. (18.42 cm) M: 4.25 in. (10.8 cm)	17.625 in. (44.77 cm)	2 in. (5.08 cm)	1.25 in. (3.18 cm)	1.25 in. (3.18 cm)	3.8 lb. (1.7 kg) 3 lb. (1.4 kg)	⚠

⚠ WARNING: Cancer and Reproductive Harm - www.P65Warnings.ca.gov

Call to Order **516-825-0727**
 Or Visit Us On-Line
Parkingproshop.com
 Bulk Pricing Available



3-CHANNEL HEAVY DUTY YELLOW JACKET®



MODEL: YJ3-225-YB

3-CHANNEL HEAVY DUTY YELLOW JACKET®

- Protects cables and hoses up to 2.125 in. outside dia.
- The “original” cable protector
- Available with Standard or Wide ramps
- Dog Bone Connectors to extend to any desired length
- Thick lid and base allow for high volume of traffic
- Modular interlocking design



MODEL: YJ3TL-225-YB



MODEL: YJ3TR-225-YB



MODEL: YJ3EB-225-Y

AMS® ACCESSIBILITY RAMP AND RAILS

for 3-Channel Heavy Duty Yellow Jacket®



MODEL: YJ3-225-YB



ADA/DDA
Compliant

AMS® ACCESSIBILITY RAMP KITS

for 3-Channel Heavy Duty Yellow Jacket®



Model	Description	Length	Width	Height	Channel Width	Maximum OD	Weight	Prop 65
YJ3-225-YB	3-CH HD YJ CP	36 in. (91.4 cm)	18.5 in. (50.8 cm)	2.875 in. (7.3 cm)	2.125 in. (5.4 cm)	2.125 in. (5.4 cm)	34.15 lb. (15.5 kg)	⚠
YJ3-225W-YB	3-CH HD YJ CP Wide Ramp	34.75 in. (88.3 cm)	26.75 in. (67.9 cm)	3.25 in. (8.3 cm)	2.125 in. (5.4 cm)	2.125 in. (5.4 cm)	62.9 lb. (28.5 kg)	⚠
YJ3TL-225-YB	45° Left Turn	23.5 in. (59.69 cm)	18.75 in. (47.63 cm)	2.875 in. (7.3 cm)	2.125 in. (5.4 cm)	2.125 in. (5.4 cm)	19 lb. (8.6 kg)	⚠
YJ3TR-225-YB	45° Right Turn	23.5 in. (59.69 cm)	18.75 in. (47.63 cm)	2.875 in. (7.3 cm)	2.125 in. (5.4 cm)	2.125 in. (5.4 cm)	18.8 lb. (8.5 kg)	⚠
YJ3EB-225-Y	End Caps (Pair Only)	F: 8.25 in. (20.96 cm) M: 8.375 in. (21.27 cm)	18.625 in. (50.17 cm) 18.625 in. (50.17 cm)	3 in. (7.62 cm) 3 in. (7.62 cm)	2.125 in. (5.4 cm) 2.125 in. (5.4 cm)	2.125 in. (5.4 cm) 2.125 in. (5.4 cm)	6.2 lb. (2.8 kg) 8.2 lb. (3.7 kg)	⚠

Model	Description	Length	Width	Height	Weight	Prop 65
WSA-225-RFAH-Y	Female Ramp	36 in. (91.44 cm)	33.25 in. (84.46 cm)	3 in. (7.62 cm)	90.1 lb. (40.9 kg)	⚠
WSA-225-RMAH-Y	Male Ramp	36 in. (91.44 cm)	33.375 in. (84.77 cm)	3 in. (7.62 cm)	90.1 lb. (40.9 kg)	⚠
WSA-225-BFF-BLU	Side Ramps - Female Pair	17.75 in. (45.09 cm)	35.5 in. (90.17 cm)	3 in. (7.62 cm)	17.2 lb. (7.8 kg) (each)	⚠
WSA-225-BFM-BLU	Side Ramps - Male Pair	17.75 in. (45.09 cm)	35.5 in. (90.17 cm)	3 in. (7.62 cm)	18.4 lb. (8.3 kg) (each)	⚠
YJ3-225-AMS-CTR-YB	3-Channel AMS® Center Section	36 in. (91.44 cm)	9.87 in. (25.07 cm)	3 in. (7.62 cm)	19.5 lb. (8.8 kg)	⚠

Model	Description	Length	Width	Height	Weight	Prop 65
WSA-225-KIT1-HS	Dog Bone Connector	71.25 in. (180.98 cm)	77.875 in. (197.8 cm)	3 in. (7.62 cm)	290.4 lb. (131.7 kg)	⚠
WSA-225-KIT2-HS	Hourglass® Connector	36 in. (91.44 cm)	77.875 in. (197.8 cm)	3 in. (7.62 cm)	199.7 lb. (90.6 kg)	⚠

⚠ WARNING: Cancer and Reproductive Harm - www.P65Warnings.ca.gov

5-CHANNEL HEAVY DUTY YELLOW JACKET® AMS® SYSTEM

3-CHANNEL HEAVY DUTY YELLOW JACKET® AMS® SYSTEM



Channel Hourglass®



IMAGE SHOWN INCLUDES:
TWO YJ5-125-AMS-M-B-B &
THREE YJ5-125-AMS-CTR-YB

5-CHANNEL HEAVY DUTY YELLOW JACKET® AMS® SYSTEM

- System includes 1 AMS® center section and 1 pair of ramps
 - Protects cables and hoses up to 1.25 in. outside diameter
 - Connect unlimited center sections and add ramps
 - Hourglass® connectors to extend to any length
 - Hinged lid for easy cable placement
 - Patented technology with modular interlocking design
 - Can be used with the YJ5 Interconnect to be used with the YJ5 standard ramps.
- (can only be used with one center section between side ramps)



Model	Description	Length	Width	Height	Channel Width	Maximum OD	Weight	Prop 65
YJ5-125-AMS-YB	AMS System (includes 1 center section & 1 pair of ramps)	36 in. (91.44 cm)	19.75 in. (50.17 cm)	2 in. (5.08 cm)	1.375 in. (3.49 cm)	1.25 in. (3.18 cm)	29.35 lb. (13.3 kg)	⚠
YJ5-125-AMS-CTR-YB	AMS Center Section	36 in. (91.44 cm)	11.75 in. (29.85 cm)	1.875 in. (4.76 cm)	1.375 in. (3.49 cm)	1.25 in. (3.18 cm)	16.65 lb. (7.6 kg)	⚠
YJ5-125-AMS-F-B	AMS Ramp Female	36 in. (91.44 cm)	5.125 in. (13.02 cm)	2 in. (5.08 cm)	N/A	N/A	7.35 lb. (3.3 kg)	⚠
YJ5-125-AMS-M-B	AMS Ramp Male	36 in. (91.44 cm)	5 in. (12.7 cm)	2 in. (5.08 cm)	N/A	N/A	5.35 lb. (2.4 kg)	⚠
YJ5I-125-YB	Interconnect	17.88 in. (45.4 cm)	19.75 in. (50.17 cm)	1.875 in. (4.76 cm)	N/A	N/A	M: 16 lb. (7.3 kg) F: 15.6 lb. (7.1 kg)	⚠



Channel Dog Bone



IMAGE SHOWN INCLUDES:
TWO YJ3-225-AMS-F-B &
THREE YJ3-225-AMS-CTR-YB

3-CHANNEL HEAVY DUTY YELLOW JACKET® AMS® SYSTEM

- System includes 1 AMS® center section and 1 pair of ramps
- Protects cables and hoses up to 2.25 in. outside diameter
- Connect unlimited center sections and add ramps
- Dog Bone connectors to extend to any length
- Hinged lid for easy cable placement
- Patented technology with modular interlocking design



Model	Description	Length	Width	Height	Channel Width	Maximum OD	Weight	Prop 65
YJ3-225-AMS-YB	AMS System (includes 1 center section & 1 pair of ramps)	36 in. (91.44 cm)	18.61 in. (47.27 cm)	3 in. (7.62 cm)	2.25 in. (5.72 cm)	2.25 in. (5.72 cm)	39 lb. (17.7 kg)	⚠
YJ3-225-AMS-CTR-YB	AMS Center Section	36 in. (91.44 cm)	9.87 in. (25.07 cm)	3 in. (7.62 cm)	2.25 in. (5.72 cm)	2.25 in. (5.72 cm)	19.5 lb. (8.8 kg)	⚠
YJ3-225-AMS-F-B	AMS Ramp Female	36 in. (91.44 cm)	5.5 in. (13.97 cm)	3 in. (7.62 cm)	N/A	N/A	10.1 lb. (4.6 kg)	⚠
YJ3-225-AMS-M-B	AMS Ramp Male	36 in. (91.44 cm)	4.7 in. (11.96 cm)	3 in. (7.62 cm)	N/A	N/A	9.4 lb. (4.3 kg)	⚠

⚠ WARNING: Cancer and Reproductive Harm - www.P65Warnings.ca.gov

Call to Order **516-825-0727**
Or Visit Us On-Line
Parkingproshop.com
Bulk Pricing Available



5-CHANNEL GENERAL PURPOSE GUARD DOG®



5-CHANNEL GENERAL PURPOSE GUARD DOG®

- Protects cables and hoses up to 1.325 in. outside dia.
- Reinforced hinged lid for easy cable placement
- All-weather polyurethane construction
- Patented 5-bar tread surface for maximum traction
- Includes four through-holes for temporary mounting



MODEL: GD5X125-OB



MODEL: GDT5X125-L-OB



MODEL: GDT5X125-R-OB



MODEL: GDEC5X125-0



MODEL: GDCR5X125-OB

ACCESSIBILITY RAMPS AND RAILS

for 5-Channel General Purpose Guard Dog®



RAILS MODEL: CPRL-5GD

RAMPS MODEL: CPRP-5GD



PROTECTOR BRIDGES

for 5-Channel General Purpose Guard Dog®



MODEL: CL2X150-GD5-0



Model	Description	Length	Width	Height	Channel Width	Maximum OD	Weight	Prop 65
GD5X125*	5-CH GP GD CP	36 in. (91.4 cm)	19.75 in. (50.17 cm)	1.875 in. (4.76 cm)	1.339 in. (3.4 cm)	1.325 in. (3.37 cm)	21 lb. (9.6 kg)	⚠
GDT5X125-L*	45° Left Turn	24.5 in. (62.23 cm)	19.75 in. (50.17 cm)	1.875 in. (4.76 cm)	1.339 in. (3.4 cm)	1.325 in. (3.37 cm)	11 lb. (5.0 kg)	⚠
GDT5X125-R*	45° Right Turn	24.5 in. (62.23 cm)	19.75 in. (50.17 cm)	1.875 in. (4.76 cm)	1.339 in. (3.4 cm)	1.325 in. (3.37 cm)	11 lb. (5.0 kg)	⚠
GDEC5X125*	End Caps (Pair Only)	F: 8.75 in. (22.23 cm) M: 5.25 in. (13.34 cm)	19.75 in. (50.17 cm)	1.875 in. (4.76 cm)	1.339 in. (3.4 cm)	1.325 in. (3.37 cm)	3 lb. (1.4 kg) 3 lb. (1.4 kg)	⚠
GDCR5X125*	90° 4-Way Cross	A: 28.5 in. (72.39 cm) A2: 24.5 in. (62.23 cm)	19.75 in. (50.17 cm)	1.875 in. (4.76 cm)	1.339 in. (3.4 cm)	1.325 in. (3.37 cm)	23.1 lb. (10.5 kg)	⚠

Model	Description	Length	Width	Height	Weight	Prop 65
CPRP-5GP-BLU	Ramps Pair (Blue)	36 in. (91.44 cm) (single)	21.88 in. (55.58 cm) (single)	2 in. (5.08 cm)	40 lb. (18.1 kg) (pair)	⚠
CPRL-5GD-Y	Rails Pair (Yellow)	2 in. (5.08 cm)	55.5 in. (140.97 cm)	2 in. (5.08 cm)	12.75 lb. (5.8 kg)	⚠

Model	Description	Length	Width	Height	Channel Width	Maximum OD	Weight	Prop 65
CL2X150-GD5*	2-CH Protector Bridge for 5-CH GP GD CP	36 in. (91.44 cm)	13 in. (33.02 cm)	2 in. (5.08 cm)	1.5 in. (3.81 cm)	1.5 in. (3.81 cm)	16 lb. (7.3 kg)	⚠

⚠ WARNING: Cancer and Reproductive Harm - www.P65Warnings.ca.gov



5-CHANNEL FLAT EDGE GENERAL PURPOSE GUARD DOG®

- Fits flush to walls, stages, curbs, or any vertical wall
- Protects cables and hoses up to 1.325 in. outside dia.
- Dog Bone Connectors to extend to any desired length
- Reinforced hinged lid for easy cable placement
- All-weather polyurethane construction
- Modular interlocking design for easy setup

MODEL: GDFE5X125-OB



ACCESSIBILITY RAMPS

for 5-Channel Flat Edge General Purpose Guard Dog®



RAMPS MODEL: CPRP-5GD



PROTECTOR BRIDGES

for 5-Channel Flat Edge General Purpose Guard Dog®



MODEL: CL2X150-GD5-0



Model	Description	Length	Width	Height	Channel Width	Maximum OD	Weight	Prop 65
GDFE5X125*	5-CH Flat Edge GP GD CP	36 in. (91.4 cm)	19.75 in. (50.17 cm)	1.875 in. (4.76 cm)	1.339 in. (3.4 cm)	1.325 in. (3.37 cm)	26.1 lb. (11.9 kg)	⚠

Model	Description	Length	Width	Height	Weight	Prop 65
CPRP-5GD-BLU	Ramps Pair (Blue)	36 in. (91.44 cm) (single)	21.88 in. (55.58 cm) (single)	2 in. (5.08 cm)	40 lb. (18.1 kg) (pair)	⚠

Model	Description	Length	Width	Height	Channel Width	Maximum OD	Weight	Prop 65
CL2X150-GD5*	2-CH Protector Bridge for 5-CH Flat Edge GP GD CP	36 in. (91.44 cm)	13 in. (33.02 cm)	2 in. (5.08 cm)	1.5 in. (3.81 cm)	1.5 in. (3.81 cm)	16 lb. (7.3 kg)	⚠

⚠ WARNING: Cancer and Reproductive Harm - www.P65Warnings.ca.gov

Call to Order **516-825-0727**
 Or Visit Us On-Line
Parkingproshop.com
 Bulk Pricing Available



5-CHANNEL GENERAL PURPOSE ADA/DDA GUARD DOG® 3-CHANNEL GENERAL PURPOSE GUARD DOG®

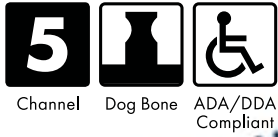

Channel Dog Bone ADA/DDA Compliant

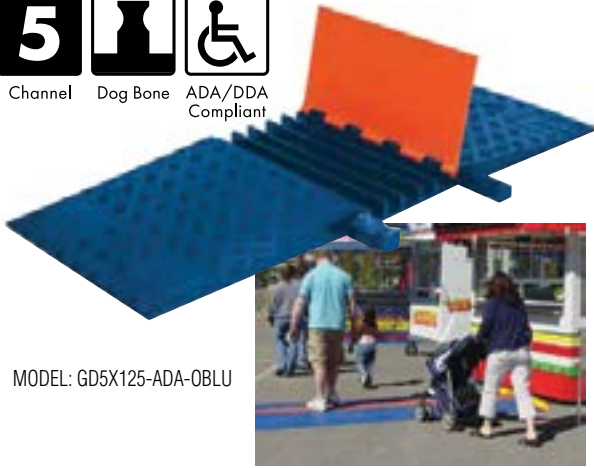

MODEL: GD5X125-ADA-OBLU

5-CHANNEL GENERAL PURPOSE ADA/DDA GUARD DOG®

- Protects cables and hoses up to 1.325 in. outside dia.
- ADA/DDA accessibility ramps built in
- Interconnects directly to a Standard Ramp 5-Channel Guard Dog Cable® Protector
- Dog Bone Connectors to extend to any desired length
- Reinforced hinged lid for easy cable placement

Model	Description	Length	Width	Height	Channel Width	Maximum OD	Weight	Prop 65
GD5X125-ADA*	5-CH GP ADA GD	18 in. (45.7 cm)	50.0 in. (127.0 cm)	1.875 in. (4.76 cm)	1.339 in. (3.4 cm)	1.325 in. (3.37 cm)	21 lb. (9.6 kg)	⚠

3-CHANNEL GENERAL PURPOSE GUARD DOG®



Channel Dog Bone

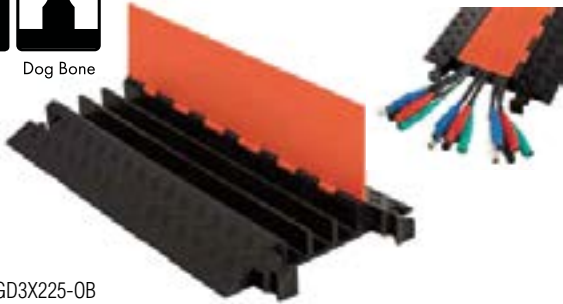

MODEL: GD3X225-OB

- Protects cables and hoses up to 2.25 in. outside dia.
- Dog Bone Connectors to extend to any desired length
- Reinforced hinged lid for easy cable placement
- All-weather polyurethane construction
- Patented 5-bar tread surface for maximum traction
- Modular interlocking design for easy setup



ADA/DDA Compliant

ACCESSIBILITY RAMPS for 3-Channel General Purpose Guard Dog®

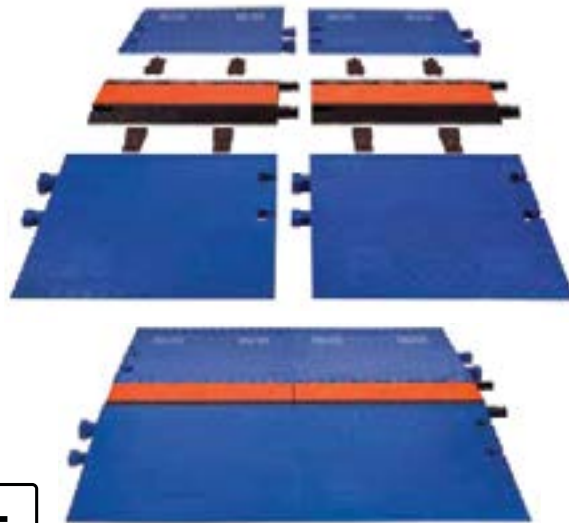

MODEL: CPRP-GD3



Model	Description	Length	Width	Height	Channel Width	Maximum OD	Weight	Prop 65
GD3X225*	3-CH GP GD CP	36 in. (91.4 cm)	20 in. (51.0 cm)	3 in. (7.65 cm)	2.25 in. (5.72 cm)	2.25 in. (5.72 cm)	30 lb. (13.6 kg)	⚠

Model	Length	Height	Height	Weight	Prop 65
CPRP-GD3-BLU	36 in. (91.4 cm)	3 in. (7.62 cm)	2.88 in. (7.32 cm)	66 lb. (30 kg) (pair of ramps)	⚠

⚠ WARNING: Cancer and Reproductive Harm - www.P65Warnings.ca.gov

LOW PROFILE GENERAL PURPOSE GUARD DOG®



LOW PROFILE GENERAL PURPOSE GUARD DOG®

- Protects cables and hoses up to .75 in. outside dia.
- Reinforced hinged lid for easy cable placement
- Available with or without ADA/DDA Accessibility Ramps
- Patented 5-bar tread surface for maximum traction



Dog Bone



ADA/DDA
Compliant



5-CHANNEL LOW PROFILE GENERAL PURPOSE GUARD DOG®



MODEL: GD5X75-ST-OB



MODEL: GD5X75-OB



Model	Description	Length	Width	Height	Channel Width	Maximum OD	Weight	Prop 65
GD5X75-ST*	5-CH w/Standard Ramp	36 in. (91.44 cm)	16.9 in. (43.0 cm)	1.25 in. (3.18 cm)	1.28 in. (3.25 cm)	.75 in. (1.9 cm)	14.75 lb. (6.69 kg)	⚠
GD5X75*	5-CH w/ADA Ramp	36 in. (91.44 cm)	33.3 in. (84.6 cm)	1.25 in. (3.18 cm)	1.28 in. (3.25 cm)	.75 in. (1.9 cm)	24.5 lb. (11.11 kg)	⚠

3-CHANNEL LOW PROFILE GENERAL PURPOSE GUARD DOG®



MODEL: GD3X75-ST-OB



MODEL: GD3X75-OB



Model	Description	Length	Width	Height	Channel Width	Maximum OD	Weight	Prop 65
GD3X75-ST*	3-CH w/Standard Ramp	36 in. (91.44 cm)	13.8 in. (35.07 cm)	1.25 in. (3.18 cm)	1.25 in. (3.25 cm)	.75 in. (1.9 cm)	12.2 lb. (5.53 kg)	⚠
GD3X75*	3-CH w/ADA Ramp	36 in. (91.44 cm)	30.3 in. (76.98 cm)	1.25 in. (3.18 cm)	1.25 in. (3.25 cm)	.75 in. (1.9 cm)	23.4 lb. (10.61 kg)	⚠

⚠ WARNING: Cancer and Reproductive Harm - www.P65Warnings.ca.gov

Call to Order **516-825-0727**
Or Visit Us On-Line
Parkingproshop.com
Bulk Pricing Available



2-CHANNEL LOW PROFILE GENERAL PURPOSE GUARD DOG®



MODEL: GD2X75-ST-0B



MODEL: GD2X75-0B



Model	Description	Length	Width	Height	Channel Width	Maximum OD	Weight	Prop 65
GD2X75-ST*	2-CH w/Standard Ramp	36 in. (91.44 cm)	11.94 in. (30.3 cm)	1.25 in. (3.18 cm)	1.5 in. (3.8 cm)	.75 in. (1.9 cm)	9.05 lb. (4.1 kg)	⚠
GD2X75*	2-CH w/ADA Ramp	36 in. (91.44 cm)	28.38 in. (72.09 cm)	1.25 in. (3.18 cm)	1.5 in. (3.8 cm)	.75 in. (1.9 cm)	22.85 lb. (10.36 kg)	⚠

1-CHANNEL LOW PROFILE GENERAL PURPOSE GUARD DOG®



MODEL: GD1X75-ST-0B



MODEL: GD1X75-0B



Model	Description	Length	Width	Height	Channel Width	Maximum OD	Weight	Prop 65
GD1X75-ST*	1-CH w/Standard Ramp	36 in. (91.44 cm)	10.81 in. (27.46 cm)	1.25 in. (3.18 cm)	2.25 in. (5.72 cm)	.75 in. (1.9 cm)	7.8 lb. (3.54 kg)	⚠
GD1X75*	1-CH w/ADA Ramp	36 in. (91.44 cm)	27.25 in. (69.22 cm)	1.25 in. (3.18 cm)	2.25 in. (5.72 cm)	.75 in. (1.9 cm)	21.1 lb. (9.55 kg)	⚠



ANTI-SLIP TRACTION KITS for Low Profile Standard Guard Dog® Ramp Models

Model	Description	Weight	Prop 65
CPRPKIT.75-20	Anti-Slip Rubber Pad Kit for all Guard Dog Low Profile Protectors with Standard Ramps (includes 20 anti-slip rubber pads)	.11 lb. (.05 kg)	⚠
CPLGUE	½ oz. Bottle of Checkers' Clear Super Glue (best if kept refrigerated). Use for permanent application of Anti-Slip Rubber Pads	.07 lb. (.032 kg)	⚠
CPCARPETKIT-3	Carpet Kit with VELCRO® Brand Fasteners for all Guard Dog Low Profile Protectors with Standard Ramps (includes two 37 in. x .25 in. Black Traction Strips and a ½ oz. Bottle of Checkers' Clear Super Glue)	.09 lb. (.041 kg)	⚠

⚠ WARNING: Cancer and Reproductive Harm - www.P65Warnings.ca.gov

3-CHANNEL GENERAL PURPOSE DROP-OVER GUARD DOG®



3-CHANNEL GENERAL PURPOSE DROP-OVER GUARD DOG®

- Protects cables and hoses up to 1.325 in. outside dia.
- Dog Bone Connectors to extend to any desired length
- Fast install with drop-over design
- All-weather polyurethane construction
- Patented 5-bar tread surface for maximum traction
- Connects to standard Guard Dog® 5-channel



ACCESSIBILITY RAMPS & RAILS

for 3-Channel General Purpose Drop Over Guard Dog®

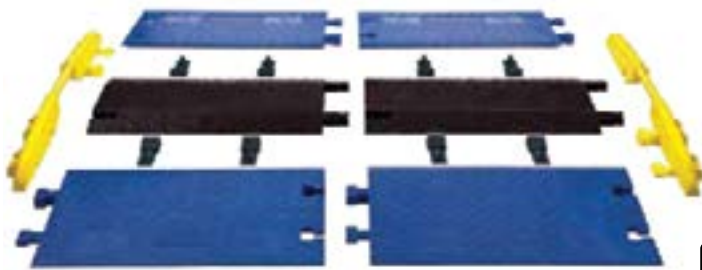

RAMPS MODEL: CPRP-4/5-BLU

RAILS MODEL: CPRL-3GD-D0-Y



ADA/DDA Compliant



Model	Description	Length	Width	Height	Channel Width	Maximum OD	Weight	Prop 65
GD3-D0*	3-CH GP Drop Over GD CP	18 in. (45.72 cm)	19.75 in.(50.36 cm)	1.87 in. (4.76 cm)	3.2 in (8.16 cm) 1.65 in. (4.21 cm)	1.325 in. (3.37 cm)	9 lb. (4.2 kg)	⚠

Model	Description	Length	Width	Height	Weight	Prop 65
CPRP-4/5-BLU	Ramps Pair	36 in. (91.44 cm) (single)	21.88 in. (55.58 cm) (single)	2 in. (5.08 cm)	40 lb. (18.1 kg) (pair)	⚠
CPRL-3GD-D0-Y	Rails Pair	2 in. (5.08 cm)	54 in. (137.16 cm)	2 in. (5.08 cm)	12.7 lb. (5.8 kg)	⚠

⚠ WARNING: Cancer and Reproductive Harm - www.P65Warnings.ca.gov

Call to Order **516-825-0727**
Or Visit Us On-Line
Parkingproshop.com
Bulk Pricing Available



FIREFLY ILLUMINATED CABLE PROTECTOR®

5-CHANNEL LIGHT DUTY BUMBLE BEE®



Channel Dog Bone



MODEL: FF5X125OB-R



MODEL: FF5X125GB-R

FIREFLY ILLUMINATED CABLE PROTECTOR®

- Battery-powered LED lights built-in to side ramps
- Multiple lid color options to match your current cable protectors
- 2 LED colors (red or blue) to choose from in the illuminated cable protector models
- On and off push button to easily turn the cable protector on or off when the LED's are needed
- Can replace AA batteries for continued uses
- High-visibility lid colors make it easily seen in low light
- Interconnects directly to a standard cable protector with a Dog Bone connection
- Protects cables and hoses up to 1.15 in. outside dia.
- All-weather polyurethane construction



Channel T-Shaped Dog Bone

MODEL: BB5-125-T-BO

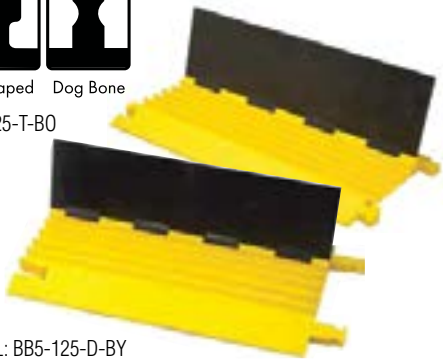

MODEL: BB5-125-D-BY

5-CHANNEL LIGHT DUTY BUMBLE BEE®

- Protects cables and hoses up to 1.25 in. outside dia.
- Available with either patented T-Connectors OR Dog Bone Connectors to extend to any desired length
- Reinforced hinged lid for easy cable placement
- Modular interlocking design
- Light duty - works great for general use



Non-Illuminated Models	Light Color	Length	Width	Height	Channel Width	Maximum OD	Weight	Prop 65
FF5X125-BLUB	N/A	32 in. (81.28 cm)	19.75 in. (60.17 cm)	1.91 in. (4.85 cm)	1.35 in. (3.43 cm)	1.15 in. (2.92 cm)	25.25 lb. (11.45 kg)	⚠
FF5X125-OB	N/A	32 in. (81.28 cm)	19.75 in. (60.17 cm)	1.91 in. (4.85 cm)	1.35 in. (3.43 cm)	1.15 in. (2.92 cm)	25.25 lb. (11.45 kg)	⚠
FF5X125-YB	N/A	32 in. (81.28 cm)	19.75 in. (60.17 cm)	1.91 in. (4.85 cm)	1.35 in. (3.43 cm)	1.15 in. (2.92 cm)	25.25 lb. (11.45 kg)	⚠
FF5X125-GB	N/A	32 in. (81.28 cm)	19.75 in. (60.17 cm)	1.91 in. (4.85 cm)	1.35 in. (3.43 cm)	1.15 in. (2.92 cm)	25.25 lb. (11.45 kg)	⚠
Illuminated Models	Light Color	Length	Width	Height	Channel Width	Maximum OD	Weight	
FF5X125BLUB-BLU	Blue	32 in. (81.28 cm)	19.75 in. (60.17 cm)	1.91 in. (4.85 cm)	1.35 in. (3.43 cm)	1.15 in. (2.92 cm)	25.25 lb. (11.45 kg)	⚠
FF5X125BLUB-R	Red	32 in. (81.28 cm)	19.75 in. (60.17 cm)	1.91 in. (4.85 cm)	1.35 in. (3.43 cm)	1.15 in. (2.92 cm)	25.25 lb. (11.45 kg)	⚠
FF5X125GB-BLU	Blue	32 in. (81.28 cm)	19.75 in. (60.17 cm)	1.91 in. (4.85 cm)	1.35 in. (3.43 cm)	1.15 in. (2.92 cm)	25.25 lb. (11.45 kg)	⚠
FF5X125GB-R	Red	32 in. (81.28 cm)	19.75 in. (60.17 cm)	1.91 in. (4.85 cm)	1.35 in. (3.43 cm)	1.15 in. (2.92 cm)	25.25 lb. (11.45 kg)	⚠
FF5X125OB-BLU	Blue	32 in. (81.28 cm)	19.75 in. (60.17 cm)	1.91 in. (4.85 cm)	1.35 in. (3.43 cm)	1.15 in. (2.92 cm)	25.25 lb. (11.45 kg)	⚠
FF5X125OB-R	Red	32 in. (81.28 cm)	19.75 in. (60.17 cm)	1.91 in. (4.85 cm)	1.35 in. (3.43 cm)	1.15 in. (2.92 cm)	25.25 lb. (11.45 kg)	⚠
FF5X125YB-BLU	Blue	32 in. (81.28 cm)	19.75 in. (60.17 cm)	1.91 in. (4.85 cm)	1.35 in. (3.43 cm)	1.15 in. (2.92 cm)	25.25 lb. (11.45 kg)	⚠
FF5X125YB-R	Red	32 in. (81.28 cm)	19.75 in. (60.17 cm)	1.91 in. (4.85 cm)	1.35 in. (3.43 cm)	1.15 in. (2.92 cm)	25.25 lb. (11.45 kg)	⚠

Model	Description	Length	Width	Height	Channel Width	Maximum OD	Weight	Prop 65
BB5-125-T-BY	5-CH LD BB CP w/T-Conn.	36 in. (91.4 cm)	17.5 in. (44.5 cm)	2.0 in. (5.1 cm)	1.25 in. (3.18 cm)	1.25 in. (3.18 cm)	21.0 lb. (9.53 kg)	⚠
BB5-125-D-BY	5-CH LD BB CP w/DB-Conn.	36 in. (91.4 cm)	19.75 in. (50.2 cm)	2.0 in. (5.1 cm)	1.25 in. (3.18 cm)	1.25 in. (3.18 cm)	21.0 lb. (9.53 kg)	⚠
BB5Y-125-T-BY	45° "Y" Connector	19.5 in. (49.53 cm)	18.0 in. (45.7 cm)	2.0 in. (5.1 cm)	1.25 in. (3.18 cm)	1.25 in. (3.18 cm)	12.0 lb. (5.44 kg)	⚠
BB5X-125-T-BY	90° 4-WAY Cross	17.5 in. (44.45 cm)	18.0 in. (45.7 cm)	2.0 in. (5.1 cm)	1.25 in. (3.18 cm)	1.25 in. (3.18 cm)	12.0 lb. (5.44 kg)	⚠
BB5EB-125-T-Y	End Caps (Pair Only)	4.8 in. (12.19 cm)	18.0 in. (45.7 cm)	2.0 in. (5.1 cm)	1.25 in. (3.18 cm)	1.25 in. (3.18 cm)	7.0 lb. (3.18 kg)	⚠

CABLE PROTECTOR TRANSPORT CARTS



MODEL: YJ2-400-YB



CABLE PROTECTOR TRANSPORT CARTS

- Easy and convenient way to transport or store multiple cable protectors
- Rugged, tubular steel frame construction
- Durable black powder-coat paint finish
- Includes front wheel locks
- Transport or store up to 10 cable protectors
- Two each 8 in. solid rubber rear wheels
- Two each 5 in. molded-on rubber, swiveling front casters with wheel locks

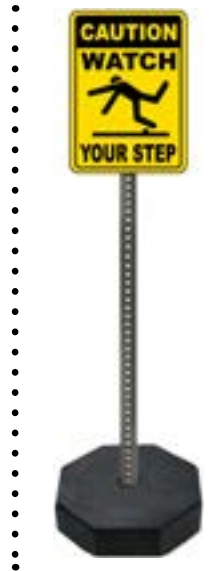

Model	Description	Length	Width	Height	Channel Width	Maximum OD	Weight	Prop 65
CT4W-ST	CP Transport Cart	32 in. (81.3 cm)	19 in. (48.3 cm)	42 in. (106.7 cm)	39 lbs. (17.7 kg)	2.25 in. (5.72 cm)	23.0 lb. (10.43 kg)	-

⚠ WARNING: Cancer and Reproductive Harm - www.P65Warnings.ca.gov

Call to Order **516-825-0727**
 Or Visit Us On-Line
Parkingproshop.com
 Bulk Pricing Available



5-CHANNEL 3-CHANNEL LIGHTWEIGHT GRIP GUARD®



Channel Grip

MODEL: GG5X125-YGRY

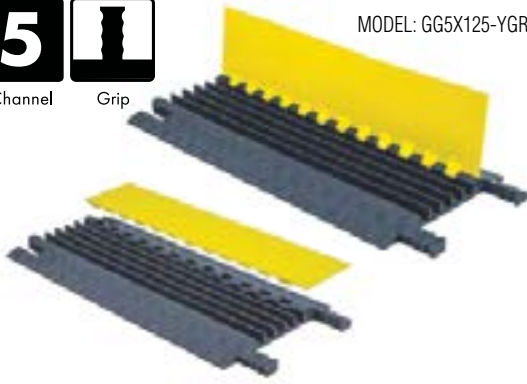

5-CHANNEL LIGHTWEIGHT GRIP GUARD®

- Patented 5-Bar tread pattern for maximum traction
- Protects cables and hoses up to 2.25 in. outside diameter
- Made from tough, high impact absorbing, non-conductive polyurethane
- Resistant from oil, fuels and lubricants
- Recessed carrying handle molded in to the underside of the protector
- Optional Anti-Slip Traction Kits for use on carpet or slick surfaces
- Custom logo and colors available



Model	Description	Length	Width	Height	Channel Width	Maximum OD	Weight	Prop 65
GG5X125-YGRY	5-CH LW GG CP	36 in. (91.4 cm)	16.44 in. (41.76 cm)	1.59 in. (4.04 cm)	1.25 in. (3.18 cm)	1.25 in. (3.18 cm)	12.75 lb. (5.78 kg)	⚠

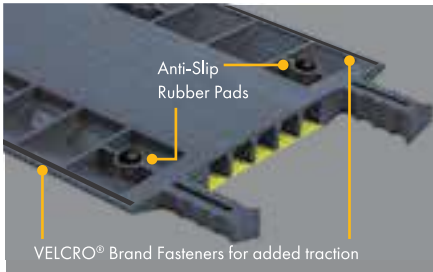

Model	Description	Length	Height	Prop 65
CPRPKIT1-8	Anti-Slip Rubber Pad Kit for Grip Guard Cable Protectors (includes 8 anti-slip rubber pads)		.11 lb. (.05 kg)	⚠
CPGLUE	½ oz. Bottle of Checkers' Clear Super Glue (best if kept refrigerated). Use for permanent application of Anti-Slip Rubber Pads		.07 lb. (.032 kg)	⚠
CPCARPETKIT-3	Carpet Kit with VELCRO® Brand Fasteners for all Guard Dog Low Profile Protectors with Standard Ramps (includes two 37 in. x .25 in. Black Traction Strips and a ½ oz. Bottle of Checkers' Clear Super Glue)		.09 lb. (.041 kg)	⚠



Channel Grip

MODEL: GG3X225-YGRY

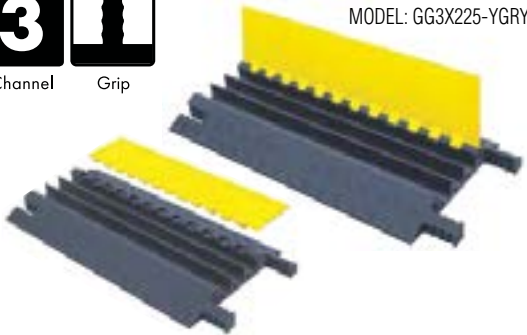

3-CHANNEL LIGHTWEIGHT GRIP GUARD®

- Patented 5-Bar tread pattern for maximum traction
- Protects cables and hoses up to 2.25 in. outside diameter
- Made from tough, high impact absorbing, non-conductive polyurethane
- Resistant from oil, fuels and lubricants
- Recessed carrying handle molded in to the underside of the protector
- Optional Anti-Slip Traction Kits for use on carpet or slick surfaces
- Custom logo and colors available



Model	Description	Length	Width	Height	Channel Width	Maximum OD	Weight	Prop 65
GG3X225-YGRY	3-CH LW GG CP	36 in. (91.44 cm)	2.69 in. (6.83 cm)	2.25 in. (5.72 cm)	2.25 in. (5.72 cm)	23.0 lb. (10.43 kg)	12.75 lb. (5.78 kg)	⚠

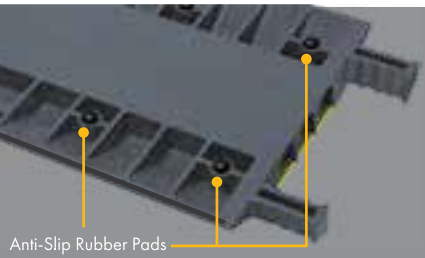

Model	Description	Weight	Prop 65
CPRPKIT1-8	Anti-Slip Rubber Pad Kit for Grip Guard Cable Protectors (includes 8 anti-slip rubber pads)	.11 lb. (.05 kg)	⚠
CPGLUE	½ oz. Bottle of Checkers' Clear Super Glue (best if kept refrigerated). Use for permanent application of Anti-Slip Rubber Pads	.07 lb. (.032 kg)	⚠
CPCARPETKIT-3	Carpet Kit with VELCRO® Brand Fasteners for all Guard Dog Low Profile Protectors with Standard Ramps (includes two 37 in. x .25 in. Black Traction Strips and a ½ oz. Bottle of Checkers' Clear Super Glue)	.09 lb. (.041 kg)	⚠

⚠ WARNING: Cancer and Reproductive Harm - www.P65Warnings.ca.gov

LIGHTWEIGHT DROP-OVER FASTLANE®



Channel L-Connector

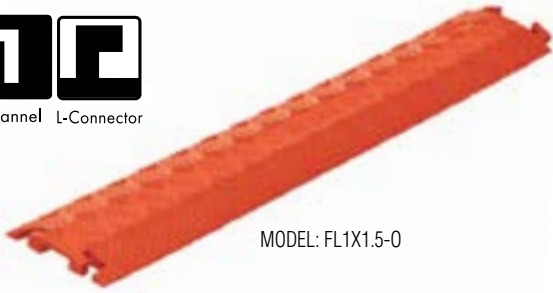

MODEL: FL1X1.5-0

LIGHTWEIGHT DROP-OVER FASTLANE®

- Protects cables and hoses up to 1 in. outside dia.
- Patented L-Connectors to extend to any length
- For lightweight vehicles and pedestrian traffic
- Patented 5-bar tread surface for maximum traction
- Universal safety colors (UV stabilized)
- Modular interlocking design for easy setup

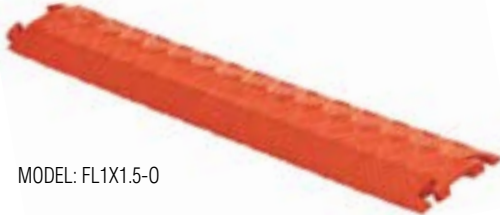

MODEL: FL1X1.5-0



MODEL: FL90LT 1x4-0

1-CHANNEL LIGHTWEIGHT DROP-OVER FASTLANE



Model	Description	Length	Width	Height	Channel Width	Maximum OD	Weight	Prop 65
FL1X1.5*	1.5 in. Channel	36 in. (91.44 cm)	5.25 in. (13.33 cm)	.75 in. (1.9 cm)	1.5 in. (3.81 cm)	.5 in. (1.27 cm)	3 lb. (1.4 kg)	⚠
FL45LT 1X1.5* FL45RT 1X1.5*	45° Turn (L/R)	7 in. (17.78 cm)	5.25 in. (13.33 cm)	.75 in. (1.9 cm)	1.5 in. (3.81 cm)	.5 in. (1.27 cm)	1 lb. (.46 kg)	⚠
FL90LT 1X1.5* FL90RT 1X1.5*	90° Turn (L/R)	7 in. (17.78 cm)	7 in. (17.78 cm)	.75 in. (1.9 cm)	1.5 in. (3.81 cm)	.5 in. (1.27 cm)	1.8 lb. (.82 kg)	⚠
FL1X4*	4 in. Channel	36 in. (91.44 cm)	10.75 in. (27.30 cm)	1.5 in. (3.81 cm)	4 in. (10.16 cm)	1 in. (2.54 cm)	8 lb. (3.6 kg)	⚠
FL45LT 1X4* FL45RT 1X4*	45° Turn (L/R)	12 in. (30.48 cm)	10.25 in. (26.04 cm)	1.5 in. (3.81 cm)	4 in. (10.16 cm)	1 in. (2.54 cm)	4 lb. (1.9 kg)	⚠
FL90LT 1X4* FL90RT 1X4*	90° Turn (L/R)	12 in. (30.48 cm)	12 in. (30.48 cm)	1.5 in. (3.81 cm)	4 in. (10.16 cm)	1 in. (2.54 cm)	6 lb. (2.8 kg)	⚠



Channel L-Connector



MODEL: FL2X1.75-B



MODEL: FL90LT 2x1.75-0

2-CHANNEL LIGHTWEIGHT DROP-OVER FASTLANE



Model	Description	Length	Width	Height	Channel Width	Maximum OD	Weight	Prop 65
FL2X1.75*	1.75 in. Channel	36 in. (91.44 cm)	10.75 in. (27.3 cm)	1.5 in. (3.81 cm)	1.75 in. (4.45 cm)	1 in. (2.54 cm)	9 lb. (4.2 kg)	⚠
FL45LT 2X1.75* FL45RT 2X1.75*	45° Turn (L/R)	12 in. (30.48 cm)	10.25 in. (26.04 cm)	1.5 in. (3.81 cm)	1.75 in. (4.45 cm)	1 in. (2.54 cm)	4 lb. (1.9 kg)	⚠
FL90LT 2X1.75* FL90RT 2X1.75*	90° Turn (L/R)	12 in. (30.48 cm)	12 in. (30.48 cm)	1.5 in. (3.81 cm)	1.75 in. (4.45 cm)	1 in. (2.54 cm)	6 lb. (2.8 kg)	⚠

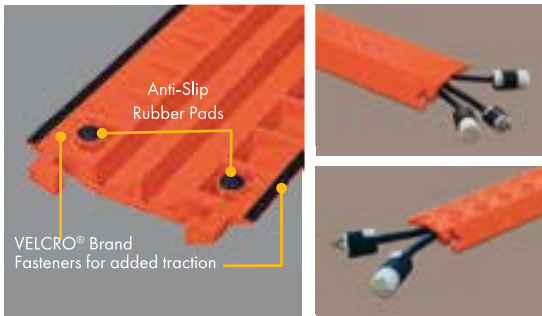

ANTI-SLIP TRACTION KITS for Lightweight Drop-Over Fastlane®

Model	Description	Weight	Prop 65
CPRPKIT.75-18	Anti-Slip Rubber Pad Kit (includes 18 rubber pads) for FL1X1.5	.11 lb. (.05 kg)	⚠
CPRPKIT1-8	Anti-Slip Rubber Pad Kit for Grip Guard Cable Protectors (includes 8 anti-slip rubber pads)	.11 lb. (.05 kg)	⚠
CPGLUE	½ oz. Bottle of Checkers' Clear Super Glue (best if kept refrigerated). Use for permanent application of Anti-Slip Rubber Pads	.07 lb. (.032 kg)	⚠
CPCARPETKIT-3	Carpet Kit with VELCRO® Brand Fasteners for all Guard Dog Low Profile Protectors with Standard Ramps (includes two 37 in. x .25 in. Black Traction Strips and a ½ oz. Bottle of Checkers' Clear Super Glue)	.09 lb. (.041 kg)	⚠

⚠ WARNING: Cancer and Reproductive Harm - www.P65Warnings.ca.gov

Call to Order **516-825-0727**
Or Visit Us On-Line
Parkingproshop.com
Bulk Pricing Available



RUBBER DUCT PROTECTORS

OPTIONAL CONNECTOR KIT



For models RFD4 - RFD9

OPTIONAL CARPET KIT



VELCRO® Brand Fasteners for added traction

RUBBER DUCT PROTECTORS

- Reduces tripping hazards
- Protects and organizes portable cords and cables
- Non-metallic, industrial-grade rubber construction
- Multiple sizes for various cable diameters
- Grooved underside for better traction
- Optional Connector Kit available for most sizes



Model	Description	Weight	Prop 65
CPCARPETKIT-5	Carpet Kit with VELCRO® Brand Fasteners for 5 ft. Rubber Duct Protectors (includes two 61in. x .25 in. Black Traction Strips and a ½ oz. Bottle of Checkers' Clear Super Glue)	.09 lb. (.041 kg)	⚠
CPCARPETKIT-10	Carpet Kit with VELCRO® Brand Fasteners for 10 ft. Rubber Duct Protectors (includes two 121in. x .25 in. Black Traction Strips and a ½ oz. Bottle of Checkers' Clear Super Glue)	12 lb. (.054 kg)	⚠

RFD1

- Single channel protector for a phone line or smalls 14 through 22 gauge wire
- Can be slit if necessary (supplied unslit)

Model	Description	Color	Weight Per Length	Prop 65
RFD1-10	10 ft. Length	B	4.60 lb. (2.1 kg)	⚠

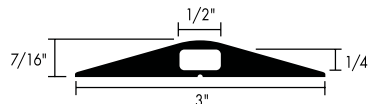

MODEL: RFD1-10



RFD2

- Two-channel protector multiple communication lines or 14 through 22 gauge wire
- Can be slit if necessary (supplied unslit)

Model	Description	Color	Weight Per Length	Prop 65
RFD2-10	10 ft. Length	B	3.70 lb. (1.7 kg)	⚠

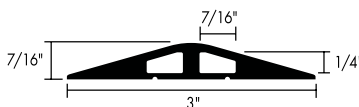

MODEL: RFD2-10



RFD3

- Center channel sized to fit standard power cords and CAT5 cable
- Protector must be slit for standard power cords due to size of plug connectors (supplied unslit)

Model	Description	Color	Weight Per Length	Prop 65
RFD3-10	10 ft. Length	B	6.85 lb. (3.2 kg)	⚠

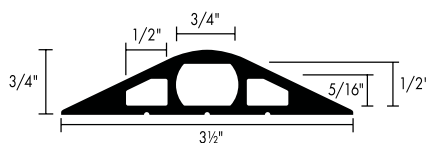

MODEL: RFD3-10



⚠ WARNING: Cancer and Reproductive Harm - www.P65Warnings.ca.gov

RUBBER DUCT PROTECTORS

RFD4

- Large channel size can accommodate multiple cables and some power plug connectors
- Can be slit if necessary (supplied unslit)

Model	Description	Color	Weight Per Length	Prop 65
RFD4-10	10 ft. Length	B	9.3 lb. (4.3 kg)	⚠
RFDCN-3/8	Optional Connector Kit (Includes two connectors)			⚠

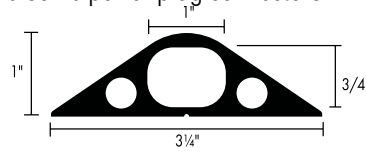

MODEL: RFD4-10



RFD5

- Three-channel protector for multiple cable applications
- Can be slit if necessary (supplied unslit)

Model	Description	Color	Weight Per Length	Prop 65
RFD5-5	5 ft. Length	B	6.20 lb. (2.8 kg)	⚠
RFD5-10	10 ft. Length	B	12.40 lb. (5.7 kg)	⚠
RFDCN-3/8	Optional Connector Kit (Includes two connectors)			⚠

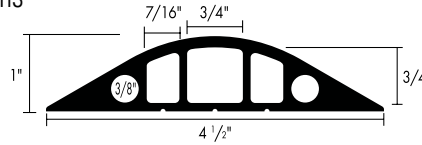

MODEL: RFD5-10



RFD6

- Large two-channel protector ideal for most multiple cable applications
- Can be slit if necessary (supplied unslit)

Model	Description	Color	Weight Per Length	Prop 65
RFD6-5	5 ft. Length	B	9.15 lb. (4.2 kg)	⚠
RFD6-10	10 ft. Length	B	18.30 lb. (8.4 kg)	⚠
RFDCN-1/2	Optional Connector Kit (Includes two connectors)			⚠

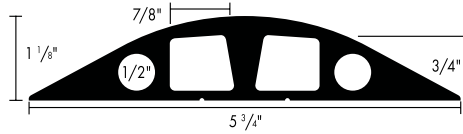

MODEL: RFD6-10



RFD7

- Heavy duty single channel protector for cable and hose lines up to 1 in. diameter
- Slit at bottom

Model	Description	Color	Weight Per Length	Prop 65
RFD7-5	5 ft. Length	B	11.4 lb. (5.2 kg)	⚠
RFDCN-1/2	Optional Connector Kit (Includes two connectors)			⚠

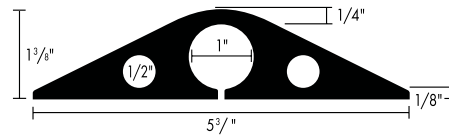

MODEL: RFD7-10



RFD8

- Heavy duty single channel protector for cable and hose lines up to 1.25 in. diameter
- Slit at bottom

Model	Description	Color	Weight Per Length	Prop 65
RFD8-5	5 ft. Length	B	14.6 lb. (6.7 kg)	⚠
RFDCN-1/2	Optional Connector Kit (Includes two connectors)			⚠

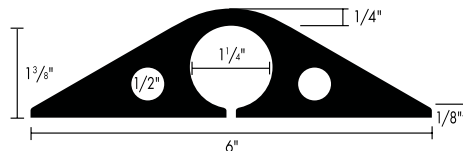

MODEL: RFD8-10



RFD9

- Heavy duty single channel protector for cable and hose lines up to 1.5 in. diameter
- Slit at bottom

Model	Description	Color	Weight Per Length	Prop 65
RFD4-10	10 ft. Length	B	9.3 lb. (4.3 kg)	⚠
RFDCN-3/8	Optional Connector Kit (Includes two connectors)			⚠

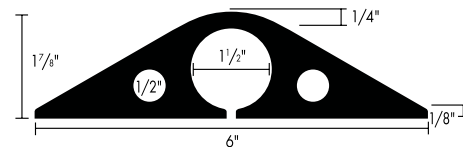

MODEL: RFD9-10



⚠ WARNING: Cancer and Reproductive Harm - www.P65Warnings.ca.gov

Call to Order **516-825-0727**
 Or Visit Us On-Line
Parkingproshop.com
 Bulk Pricing Available



1-TUNNEL LARGE HOSE BRIDGE DIAMONDBACK SYSTEMS® CUSTOM BRIDGE SYSTEMS



1-TUNNEL LARGE HOSE BRIDGE DIAMONDBACK SYSTEMS®

- Protect large lines up to 6.5 in. outside diameter
- Single or multiple tunnel systems available
- Multiple sizes for various hose & cable diameters
- Reduces maintenance and replacement costs
- Modular interlocking design for easy setup, transport & storage
- Polyurethane construction is abrasion, impact and weather resistant with high load-bearing capacity
- Diamond-plate tread surface increases traction
- Yellow caution color for high visibility
- Built-in hand holds allow for handling with ease and double as attachment points for mounting brackets



LOAD CAPACITY

Model	Max Load Per Tire
UHB2025	23,700 lb. (10,750 kg)
UHB3035	19,800 lb. (8,981 kg)
UHB4045	19,300 lb. (8,754 kg)
UHB5060	17,100 lb. (7,757 kg)



Model	Description	A: Bridge Length	B: Bridge Width	C: Bridge Height	D: Tunnel Diameter	E: Tunnel Top Length	F: Tunnel Base Length	G: Ramp Top Length	H: Ramp Base Length	Weight	Prop 65
UHB2025	Bridge for up to 3 in. lines	34.75 in. (88.7 cm)	16 in. (40.6 cm)	3.88 in. (9.9 cm)	3 in. (7.62 cm)	5.38 in. (13.9 cm)	13.25 in. (33.8 cm)	14.75 in. (37.7 cm)	10.75 in. (27.5 cm)	32 lb. (14.5 kg)	⚠
UHB3035	Bridge for up to 3.5 in. lines	38.25 in. (97.6 cm)	16 in. (40.6 cm)	4.63 in. (11.8 cm)	3.5 in. (8.89 cm)	6.5 in. (16.6 cm)	14.38 in. (36.7 cm)	16 in. (40.8 cm)	12 in. (30.6 cm)	40 lb. (18.1 kg)	⚠
UHB4045	Bridge for up to 4.5 in. lines	44 in. (111.8 cm)	16 in. (40.6 cm)	5.5 in. (14.1 cm)	4.5 in. (11.43 cm)	7.75 in. (19.8 cm)	15.63 in. (39.9 cm)	18.25 in. (46.6 cm)	14.25 in. (36.4 cm)	50 lb. (22.7 kg)	⚠
UHB5060	Bridge for up to 6.5 in. lines	60 in. (153.0 cm)	16 in. (40.6 cm)	8.13 in. (20.8 cm)	7 in. (17.9 cm)	9.13 in. (23.3 cm)	18.25 in. (46.6 cm)	25.5 in. (65.1 cm)	20.88 in. (53.3 cm)	92 lb. (41.7 kg)	⚠



CUSTOM BRIDGE SYSTEMS

LOAD CAPACITY

Model	Max Load Per Tire
UHB2025	23,700 lb. (10,750 kg)
UHB3035	19,800 lb. (8,981 kg)
UHB4045	19,300 lb. (8,754 kg)
UHB5060	17,100 lb. (7,757 kg)

3 INCH TUNNEL OPTIONS

Model	Description	Weight	Prop 65
UHB2025T (Each)	Tunnel only, for up to 3 in. lines	15 lb. (6.8 kg)	⚠
UHB2025R (Pair)	Ramps only, for UHB2025 Tunnel	18 lb. (8.2 kg)	⚠
UHB2025TC (Each)	Tunnel Connector only, for UHB2025T Tunnel	11 lb. (5 kg)	⚠

3.5 INCH TUNNEL OPTIONS

Model	Description	Weight	Prop 65
UHB3035T (Each)	Tunnel only, for up to 3.5 in. lines	17 lb. (7.7 kg)	⚠
UHB3035R (Pair)	Ramps only, for UHB3035 Tunnel	22 lb. (10 kg)	⚠
UHB3035TC (Each)	Tunnel Connector only, for UHB3035T Tunnel	16 lb. (7.3 kg)	⚠

4.5 INCH TUNNEL OPTIONS

Model	Description	Weight	Prop 65
UHB4045T (Each)	Tunnel only, for up to 4.5 in. lines	21 lb. (9.5 kg)	⚠
UHB4045R (Pair)	Ramps only, for UHB4045 Tunnel	30 lb. (13.6 kg)	⚠
UHB4045TC (Each)	Tunnel Connector only, for UHB4045T Tunnel	21 lb. (9.5 kg)	⚠

6.5 INCH TUNNEL OPTIONS

Model	Description	Weight	Prop 65
UHB5060T (Each)	Tunnel only, for up to 6.5 in. lines	32 lb. (6.8 kg)	⚠
UHB5060R (Pair)	Ramps only, for UHB5060 Tunnel	58 lb. (26.3 kg)	⚠
UHB5060TC (Each)	Tunnel Connector only, for UHB5060T Tunnel	26 lb. (11.8 kg)	⚠

⚠ **WARNING: Cancer and Reproductive Harm - www.P65Warnings.ca.gov**

CREATE A CUSTOM BRIDGE SYSTEM

100% RECYCLED PLASTIC HOSE BRIDGES, CURB RAMPS, UTILITY CROSSOVER SYSTEMS



MODEL: CHHBS

100% RECYCLED PLASTIC HOSE BRIDGES

- Create a pedestrian/vehicle bridge anywhere
- Modular system that one person can carry and easily assemble
- Standard Bridge includes 2 female sections Standard Bridge includes 2 female sections complete ramps that can accommodate hoses up to 5 in. outside diameter
- Super Bridge includes 3 female sections and 3 male sections which makes two complete ramps that can accommodate hoses up to 10 in. outside diameter
- 100% recycled plastic construction
- Industrial grade Custom logo and colors available

Model	Length	Width	Height	Weight	Prop 65
CHHBS (Standard)	70 in. (177.8 cm)	24.5 in. (62.2 cm)	6.75 in. (17.2 cm)	240 lb. (109 kg)	-
CHHBS68 (Super)	126 in. (320 cm)	24.5 in. (62.2 cm)	12.5 in. (31.8 cm)	540 lb. (245 kg)	-

OPTIONS

Model	Description	Prop 65
CHWSHBS	Grit Top Walking Surface for Standard Bridge	-
CHWSHBS68	Grit Top Walking Surface for Super Bridge	-
CH-HJ	Hose Bridge Joiner	-
CHPD-R	Single Side Rail	-
CHPB-R2	Double Side Rail	-



BEFORE



AFTER



CURB RAMPS

- Optional single or double railing configurations available in powder-coated yellow or brushed aluminum.

Model	Length	Width	Height	Weight	Prop 65
CHCR	36 in. (91.4 cm)	24 in. (60.9 cm)	6.75 in. (17.1 cm)	52 lb. (23.6 kg)	-

1

Channel



MODEL: COP2200-4.5-Y

UTILITY CROSSOVER SYSTEMS

- Polyurethane construction
- Convenient carrying handle
- Replaceable rubber traction pads
- 4.5 in. tunnel size
- Lightweight and portable



Model	Description	Width	Height	Channel Width	Maximum OD	Weight	Prop 65
COP2200-4.5-Y	Utility Crossover System	30 in. (76.2 cm)	6 in. (15.2 cm)	4.5 in. (11.4 cm)	35 lb. (15.9 kg)	9 lb. (4.2 kg)	⚠

⚠ WARNING: Cancer and Reproductive Harm - www.P65Warnings.ca.gov

Call to Order **516-825-0727**
Or Visit Us On-Line
Parkingproshop.com
Bulk Pricing Available



HEAVY DUTY MC SERIES (CONT.)



MODEL: MC3009

MC3009 recommended tire diameter 46 in. to 65 in. (116.8 cm to 165.1 cm)

- For mine support equipment such as lubrication trucks and maintenance vehicles
- Max Gross Vehicle Operating Weight up to 245,000 lbs. or 111,130 kg
- For Payloads up to 70 tons* (63,503 kg) use two MC3009
- Tough urethane construction
- Recessed carrying handle
- Safety yellow color
- Mounting hole for ropes, chains or brackets
- Replaceable rubber anti-slip traction pads with aluminum mounting plates to resist delamination due to corrosion
- Molded-in ANSI Z535.4 compliant proper chocking guidelines

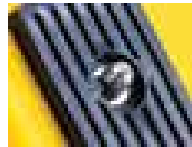

MCSTUD

Model	Length	Width	Height	Weight	Color	Prop 65
MC3009	15 in. (38.1 cm)	15.1 in. (38.4 cm)	11 in. (28.0 cm)	14.5 lb. (6.6 kg)	Yellow	⚠
MCPAD12X2.5	Replacement traction pad for MC3009 & MC1909			1.5 lb. (.7 kg)	Black	-
MCSTUD-3/8X1.5	Optional stainless steel studs for snow and ice. Requires 4 per MC3009 and MC1909			.06 lb. (.027 kg) Each	Grey	-

⚠ WARNING: Cancer and Reproductive Harm - www.P65Warnings.ca.gov

MC SERIES MOUNTING BRACKET for MC3011, MC3012, MC3010 & MC3009 chocks

- Mounting Hardware NOT included

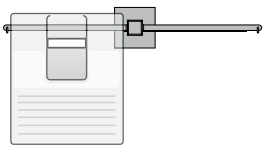

MODEL: MC1900

Model	Description	Specifications	Weight	Prop 65
MC1900	Universal Dual Mounting Bracket holds 2 each of MC Series Wheel Chocks. Primer Finish.	36 in. (91.4 cm) Length . Bracket Rod with 6" (15.2 cm) Mounting Plate	16 lb. (7.3 kg)	-

HEAVY DUTY AT SERIES

HEAVY DUTY AT SERIES

- Lighter weight with tough urethane construction
- ANSI compliant color written guidelines on proper chocking procedures
- Complies with SAE-J348, NFPA 1901, 1906, and 1911 Standard
- Resistant to oils, fuels and solvents
- Recessed carrying handle on the backside of the chock
- Replaceable aluminum traction cleats or rubber pads
- Mounting hole for ropes, chains or brackets

AT3514 recommended tire diameter 36 in. to 46 in. (91.4 cm to 116.8 cm)

- For vehicles with tire sizes of 36 in. to 46 in. (91.4 cm to 116.8 cm) and gross vehicle operating weight up to 150,000 lb. (68,039 kg)

Model	Base Design	Length	Width	Height	Weight	Prop 65
AT3514-AC-Y	Aluminum Cleat Cored Bottom	21 in. (53.3 cm)	11.25 in. (28.6 cm)	12.25 in. (31.1 cm)	16.5 lb. (7.5 kg)	⚠
AT3514-FBAC-Y	Aluminum Cleat Flat Bottom	21 in. (53.3 cm)	11.25 in. (28.6 cm)	12.25 in. (31.1 cm)	18.8 lb. (8.6 kg)	⚠
AT3514-RP-Y	Rubber Pad Cored Bottom	21 in. (53.3 cm)	11.25 in. (28.6 cm)	12.25 in. (31.1 cm)	16.1 lb. (7.3 kg)	⚠
AT3514-FBRP-Y	Rubber Pad Flat Bottom	21 in. (53.3 cm)	11.25 in. (28.6 cm)	12.25 in. (31.1 cm)	17.5 lb. (8.0 kg)	⚠
ATCLEAT-3514	Replacement Aluminum Cleat for cored or flat bottom				2.0 lb (.9 kg)	-
ATPAD-2514	Replacement Rubber Pad for cored or flat bottom				.9 lb (.4 kg)	-



⚠ WARNING: Cancer and Reproductive Harm - www.P65Warnings.ca.gov

AT3512 recommended tire diameter 28 in. to 38 in. (71.1 cm to 96.5 cm)

- For vehicles with tire diameter of 28 in. to 38 in. (71.1 cm to 96.5 cm) and gross vehicle operating weight up to 80,000 lb. (36,287 kg)

Model	Base Design	Length	Width	Height	Weight	Prop 65
AT3512-AC-Y	Aluminum Cleat Cored Bottom	15.5 in. (39.4 cm)	8.5 in. (21.6 cm)	8.25 in. (21.0 cm)	7.1 lb. (3.2 kg)	⚠
AT3512-FBAC-Y	Aluminum Cleat Flat Bottom	15.5 in. (39.4 cm)	8.5 in. (21.6 cm)	8.25 in. (21.0 cm)	7.5 lb.(3.4 kg)	⚠
AT3512-RP-Y	Rubber Pad Cored Bottom	15.5 in. (39.4 cm)	8.5 in. (21.6 cm)	8.25 in. (21.0 cm)	7.1 lb. (3.2 kg)	⚠
AT3512-FBRP-Y	Rubber Pad Flat Bottom	15.5 in. (39.4 cm)	8.5 in. (21.6 cm)	8.25 in. (21.0 cm)	7.5 lb.(3.4 kg)	⚠
ATCLEAT-3512	Replacement Aluminum Cleat for cored or flat bottom				.625 lb (.3 kg)	-
ATPAD-2512	Replacement Traction Pad for cored or flat bottom				2.0 lb (.9 kg)	-



⚠ WARNING: Cancer and Reproductive Harm - www.P65Warnings.ca.gov

AT SERIES MOUNTING BRACKET for AT3512, AT514 & AT3500 Chocks

Model	Description	Coating	Weight	Prop 65
AT2512VM	Vertical Mounting Bracket for 3512 Series 14" x 12" x 5.75"	Zinc Plated	3.2 lb. (1.5 kg)	-
AT2512HM	Horizontal Mounting Bracket for 3512 Series 16" x 11.13" x 6.25"	Zinc Plated	5.3 lb. (2.4 kg)	-
AT2514HM	Horizontal Mounting Bracket for 3514 Series 21.75" x 14.13" x 6.75"	Zinc Plated	8.0 lb. (3.7 kg)	-
AT2500	Universal Dual Mounting Bracket holds 2 each 3500 Series Wheel Chocks of any size. 26.26" (66.7 cm) Length Bracket Rod with 6" (15.2 cm) Square Mounting Plate.	Black Powder Coated Finish	13.5 lb. (6.2 kg)	-

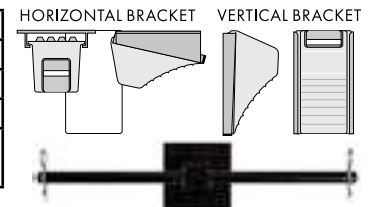

Call to Order **516-825-0727**
 Or Visit Us On-Line
Parkingproshop.com
 Bulk Pricing Available



AC200 SERIES for small aircraft

AC200 SERIES for small aircraft

Fits the curvature of the tire to absorb wheel-squat during loading and fueling operations. Features molded-in soft base for increased traction. 3/8 in. x 24 in. replaceable polyester rope lanyard connects two chocks together. Custom rope lengths available. Sold in pairs.



MODEL: AC201



MODEL: UC200-S



Model	Length	Width	Height	Lanyard	Weight (pair)	Color	Prop 65
AC201	5.5 in. (14.0 cm)	4.5 in. (11.4 cm)	2.75 in. (7.0 cm)	24 in. (61.0 cm)	1.5 lb. (.68 kg)	Hi-Vis Yellow	⚠
UC200-S	5.5 in. (14 cm)	4.5 in. (11.4 cm)	2.5 in. (6.3 cm)	24 in. (61.0 cm)	1.6 lb (.7 kg)	Orange	⚠



⚠ WARNING: Cancer and Reproductive Harm - www.P65Warnings.ca.gov



Call to Order **516-825-0727**
Or Visit Us On-Line
Parkingproshop.com
Bulk Pricing Available



GENERAL PURPOSE RUBBER WHEEL CHOCKS BARRICADE LIGHT REPLACEMENT PARTS

GENERAL PURPOSE RUBBER WHEEL CHOCKS

- Highly durable rubber construction
- Resistant to weather elements
- Either side can be positioned against the tire
- Ideal for smaller vehicles and trailers
- Small design makes for easy storage
- RC450 Series offers 4 different base options

RC450 standard of the utility industry

- RC450 is available with either a steel loop carrying handle or an eyebolt for ropes or chains
- Fits most chock storage compartments



MODEL: RC450 RC450-S RC450-CL RC450-GR



MODEL: RC450-E

Model	Description	Length	Width	Height	Weight	Prop 65
RC450	Bottom Void, Steel Loop	10 in. (25.4 cm)	8 in. (20.3 cm)	5.5 in. (14.0 cm)	7 lb. (3.2 kg)	-
RC450-S	Solid Bottom, Steel Loop	10 in. (25.4 cm)	8 in. (20.3 cm)	5.5 in. (14.0 cm)	10 lb. (4.5 kg)	-
RC450-CL	Bottom Void and Aluminum Ice Cleat, Steel Loop	10 in. (25.4 cm)	8 in. (20.3 cm)	5.5 in. (14.0 cm)	8.5 lb. (3.9 kg)	-
RC450-GR	Bottom Void and 14ga. Steel Grate, Steel Loop	10 in. (25.4 cm)	8 in. (20.3 cm)	5.5 in. (14.0 cm)	9.2 lb. (4.2 kg)	-
RC450-E	Bottom Void, Eyebolt	10 in. (25.4 cm)	8 in. (20.3 cm)	5.5 in. (14.0 cm)	7 lb. (3.2 kg)	-

RC815 for "over the road" trucks and trailers and loading dock facilities

- Ribbed pyramid design
- Eyebolt for ropes or chains
- Either side can be positioned against tire
- Ideal for keeping truck trailers in place during loading or unloading



MODEL: RC815

Model	Description	Length	Width	Height	Weight	Prop 65
RC815	Wheel Chock with Bottom Void	10 in. (25.4 cm)	8 in. (20.3 cm)	6 in. (15.2 cm)	8.5 lb. (3.9 kg)	-

RC915 for heavy trucks, trailers and road construction equipment

- Ribbed pyramid design
- Eyebolt for ropes or chains
- Either side can be positioned against the tire



MODEL: RC915

Model	Description	Length	Width	Height	Weight	Prop 65
RC915	Wheel Chock with Bottom Void	11.5 in. (29.2 cm)	10 in. (25.4 cm)	7.25 in. (18.4 cm)	15 lb. (6.8 kg)	-

GENERAL PURPOSE RUBBER WHEEL CHOCKS

D-CELL ECONOMY BARRICADE LIGHT REPLACEMENT PARTS

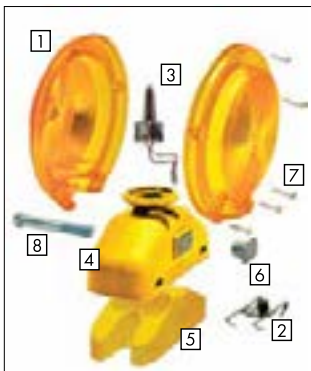

#	Model	Description	Prop 65
1	Z503.09*	Barricade Lens	-
2	04.BC3.CKT.A	D-Cell Economy Circuit	⚠
3	04.BC.EMITTER.A	LED and Holder	⚠
4	Z503.03**	Economy D-Cell Top	⚠
5	Z503.04**	Economy D-Cell Bottom	-
6	Z503.006	Nut Plate	-
7	Z503.008	Replacement Lens Screw	-
8	Z503.03D	D3 3.5 in. D Bolt	-
	Z503.013	Switch Pin (not pictured)	⚠
	Z503.017D	D Bolt Wrench (not pictured)	-

6 VOLT ECONOMY BARRICADE LIGHT REPLACEMENT PARTS

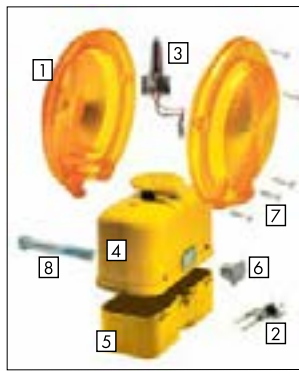

#	Model	Description	Prop 65
1	Z503.09*	Barricade Lens	-
2	04.BC6.CKT.A	6 Volt Economy Circuit	⚠
3	04.BC.EMITTER	LED and Holder	⚠
4	Z506.015**	6 Volt Economy Top Case	⚠
5	Z506.016**	6 Volt Economy Bottom Case	-
6	Z503.006	Nut Plate	-
7	Z503.008	Replacement Lens Screw	-
8	Z503.03D	D3 3.5 in. D Bolt	-
	Z503.013	Switch Pin (not pictured)	⚠
	Z503.017D	D Bolt Wrench (not pictured)	-

⚠ **WARNING: Cancer and Reproductive Harm - www.P65Warnings.ca.gov**

BARRICADE LIGHT REPLACEMENT PARTS

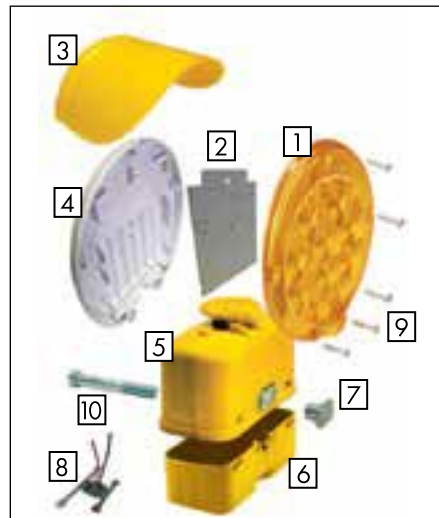
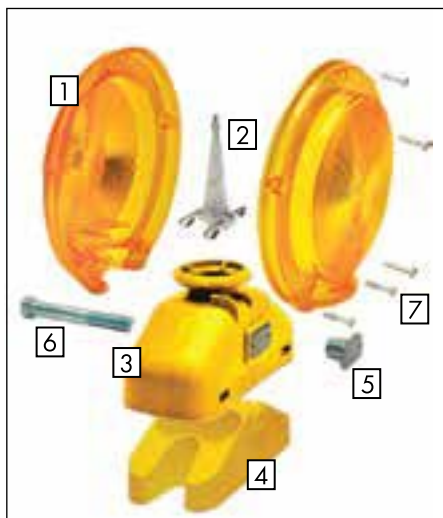

D-CELL PREMIUM BARRICADE LIGHT REPLACEMENT PARTS

6 VOLT PREMIUM BARRICADE LIGHT REPLACEMENT PARTS

PREMIUM SOLAR BARRICADE LIGHT REPLACEMENT PARTS

#	Model	Description	Prop 65
1	Z503.09*	Replacement Barricade Lens	-
2	04.BR3.CKT.A	D-Cell Premium Circuit	⚠
3	Z503.05**	Premium D-Cell Top	⚠
4	Z503.06**	Premium D-Cell Bottom	-
5	Z503.006	Nut Plate	-
6	Z503.03D	D3 3.5 in. D Bolt	-
7	Z503.008	Replacement Lens Screw	-
	Z503.013	Switch Pin (not pictured)	⚠
⚠	Z503.017D	D Bolt Wrench (not pictured)	-

#	Model	Description	Prop 65
1	Z503.023*	Replacement B-Light Lens	-
2	04.BB.CKTM.A	B-Light Premium Circuit	⚠
3	Z503.018	Yellow Visor	-
4	Z503.024W	White Back	-
5	Z503.021**	Premium 6 Volt Top Case	⚠
6	Z503.022**	Premium 6 Volt Bottom Case	-
7	Z503.006	Nut Plate	-
8	04.BB.CKT6V.SW	6 Volt Battery Board	-
9	Z503.008	Replacement Lens Screw	-
10	Z503.03D	D3 3.5 in. D Bolt	-
	503.013	Switch Pin (not pictured)	⚠
	Z503.017D	D Bolt Wrench (not pictured)	-

#	Model	Description	Prop 65
1	Z507.03*	360 Degree Dome Lens	-
2	Z503.050	Lens Clamp	-
3	Z503.09*	Replacement Barricade Lens	-
4	Z503.047**	Solar Barricade Case Back Side	-
5	Z503.046**	Solar Barricade Case Front Side	-
6	05.BS.CKT.ASM.***	Solar Type A/C Circuit	⚠
7	Z544.020	Solar Nut Plate	-
8	Z400.100	Nut Plate O-Ring	-
9	Z503.060	Solar Case Screw	-
10	Z503.008	Replacement Lens Screw	-
11	Z503.017	D3 2.25" in. D Bolt	-
12	Z503.075D	D3 1.75 in. D Bolt	-
	Z503.013	Switch Pin (not pictured)	⚠
	Z503.017D	D Bolt Wrench (not pictured)	-

WARNING: Cancer and Reproductive Harm
www.P65Warnings.ca.gov

⚠ WARNING: Cancer and Reproductive Harm
www.P65Warnings.ca.gov

*SPECIFY LENS COLOR: A = AMBER, B = BLUE, C = CLEAR, G = GREEN, R = RED ** SPECIFY CASE COLOR: Y = YELLOW (CUSTOM COLORS AVAILABLE)



Call to Order **516-825-0727**
 Or Visit Us On-Line
Parkingproshop.com
 Bulk Pricing Available



LED1350 CLASS II LED BEACONS

LED1350 CLASS II LED BEACONS

- Integrated heat sink allows LEDs to be driven at higher intensities without sacrificing performance
- Can be used as a steady burn, non-flashing beacon
- Lens and dust cover made from UV-stabilized polycarbonate
- Only high powered LED beacon on the market that can be used as a steady burn, non-flashing beacon
- 10 changeable flash patterns including high intensity rotational light output
- Intelligent automatic dimming control included
- Magnet Mount option includes Neodymium anti-scratch magnets that are positioned wider on the base for superior holding power while eliminating vehicle scratches and scuffs
- Dual power plug switch allows user to easily switch flash patterns without leaving driver seat (including off)



LED1350 Specifications	
Lens Color	Amber
Operating Voltage	12-48 Volts, DC
Maximum Current	750 mA @ 12 VDC
Flash Patterns	10 Flash Patterns including Steady, Rotational Flash, HexaFlash, PentaFlash, Quad, Double, Day/Night mode, and more.
Flashes Per Minute (FPM)	120-360 Range (Varies per mode)
Lumen Output	1350
LED Count	12 LEDs
Base Diameter	6.4 Inches
Overall Height	High Dome - 6 in.; Low Dome - 4 in.
Mounting	Standard - 3 hole flange with three 12 in. wire pigtailed. Optional bolt on attachment for 1 in. NPT pipe mount; Magnet - Combination 3 hole flange and 100 lb. pull magnet mount including 15 ft straight cord and 2-way switch power plug. Optional bolt on attachment for 1 in. NPT pipe mount.
Approval	Independent Lab Certified, SAE-J845 Class I; CA Title 13
Temperature Range	-60° F to 140° F (-50° C to 60° C)
Warranty	5 Year

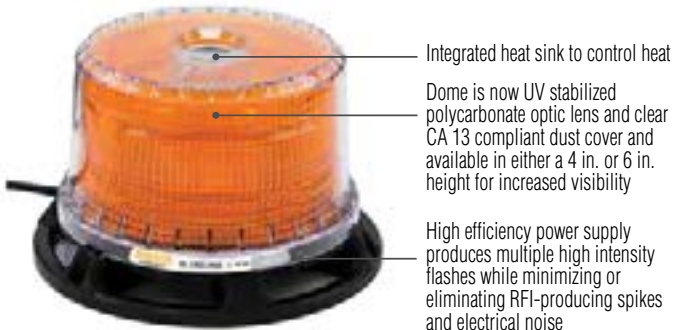

HEAVY DUTY LED1350 BEACONS

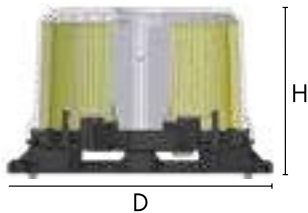

Model	Description	Lumens	Diameter	Height	Prop 65
SL.1350.HMA	LED Beacon Class II with Magnet Mount (3 hole flange, and 100 lb. pull magnet mount including 15 ft straight cord and 2-way switch power plug) Optional 1 in. pipe mount.	1350	6.4 in. (16.25 cm)	6.5 in. (16.5 cm)	⚠
SL.1350.HSA	LED Beacon Class II with Standard Mount (3 hole flange with three 12 in. wire pigtailed) Optional 1 in. pipe mount.	1350	6.4 in. (16.25 cm)	6.5 in. (16.5 cm)	⚠
SL.1350.LMA	LED Beacon Class II with Magnet Mount (3 hole flange, and 100 lb pull magnet mount including 15 ft straight cord and 2-way switch power plug) Optional 1 in. pipe mount.	1350	6.4 in. (16.25 cm)	4.65 in. (11.9 cm)	⚠
SL.1350.LSA	LED Beacon Class II with Standard Mount (3 hole flange with three 12 in. wire pigtailed) Optional 1 in. pipe mount.	1350	6.4 in. (16.25 cm)	4.65 in. (11.9 cm)	⚠

⚠ **WARNING: Cancer and Reproductive Harm - www.P65Warnings.ca.gov**

LED2250 CLASS I BEACONS

LED2250 CLASS I BEACONS

- Integrated heat sink allows LEDs to be driven at higher intensities without sacrificing performance
- Can be used as a steady burn, non-flashing beacon
- Lens and dust cover made from UV-stabilized polycarbonate
- Only high-powered, 15 watt LED beacon on the market that can be used as a steady burn, non-flashing beacon
- 10 changeable flash patterns including high intensity rotational light output
- Intelligent automatic dimming control included
- Magnet Mount option includes Neodymium anti-scratch magnets that are positioned wider on the base for superior holding power while eliminating vehicle scratches and scuffs
- Dual power plug switch allows user to easily switch flash patterns without leaving driver seat (including off)



LED2250 Specifications	
Lens Color	Amber
Operating Voltage	12-48 Volts, DC
Maximum Current	1.5 A @ 12 VDC
Flash Patterns	10 Flash Patterns including Steady, Rotational Flash, HexaFlash, PentaFlash, Quad, Double, Day/Night mode, and more.
Flashes Per Minute (FPM)	120-360 Range (Varies per mode)
Lumen Output	2250
LED Count	24 LEDs
Base Diameter	6.4 Inches
Overall Height	High Dome - 6 in.; Low Dome - 4 in.
Mounting	Standard - 3 hole flange with three 12 in. wire pigtails. Optional bolt on attachment for 1" in. NPT pipe mount; Magnet - Combination 3 hole flange and 100 lb. pull magnet mount including 15 ft straight cord and 2-way switch power plug. Optional bolt on attachment for 1 in. NPT pipe mount.
Approval	Independent Lab Certified, SAE-J845 Class I; CA Title 13
Temperature Range	-60° F to 140° F (-50° C to 60° C)
Warranty	5 Year



Integrated heat sink to control heat

Dome is now UV stabilized polycarbonate optic lens and clear CA 13 compliant dust cover and available in either a 4 in. or 6 in. height for increased visibility

Dome is now UV stabilized polycarbonate optic lens and clear CA 13 compliant dust cover and available in either a 4 in. or 6 in. height for increased visibility



Integrated Heat Sink to control heat



Optional Neodymium anti-scratch magnets are positioned wider on the base for superior holding power

15 ft. power cord with 2-way switch power plug

HEAVY DUTY LED2250 BEACONS

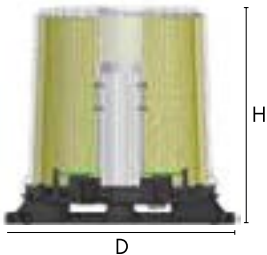

Model	Description	Lumens	Diameter	Height	Prop 65
SL.2250.HMA	LED Beacon Class 1 with Magnet Mount (3 hole flange, and 100 lb pull magnet mount including 15 ft straight cord and 2-way switch power plug) Optional 1 in. pipe mount.	2250	6.3 in. (16 cm)	6.5 in. (16.5 cm)	⚠
SL.2250.HSA	LED Beacon Class 1 with Standard Mount (3 hole flange with three 12 in. wire pigtails) Optional 1 in. pipe mount.	2250	6.3 in. (16 cm)	6.5 in. (16.5 cm)	⚠
SL.2250.LMA	LED Beacon Class 1 with Magnet Mount (3 hole flange, and 100 lb pull magnet mount including 15 ft straight cord and 2-way switch power plug) Optional 1 in. pipe mount.	2250	6.3 in. (16 cm)	4.65 in. (11.9 cm)	⚠
SL.2250.LSA	LED Beacon Class 1 with Standard Mount (3 hole flange with three 12 in. wire pigtails) Optional 1 in. pipe mount.	2250	6.3 in. (16 cm)	4.65 in. (11.9 cm)	⚠

⚠ WARNING: Cancer and Reproductive Harm - www.P65Warnings.ca.gov

Call to Order **516-825-0727**
 Or Visit Us On-Line
Parkingproshop.com
 Bulk Pricing Available



LED300 CLASS III BEACONS

LED300 CLASS III BEACONS

- Four high intensity LEDs for increased visibility
- Can be used as a steady burn, non-flashing beacon
- High efficiency power supply
- Dome made from UV-stabilized polycarbonate
- Meets SAE-J845 Class III requirements
- Easy twist-on dome made from durable, UV-stabilized polycarbonate
- 8 flash patterns including steady (Additional Flash Patterns can be programmed)
- Magnet Mount option includes Neodymium anti-scratch magnets that are positioned wider on the base for superior holding power while eliminating vehicle scratches and scuffs
- Dual power cord switch allows user to easily switch flash patterns without leaving driver seat (including off)
- Optional 1/2 in. NPT Pipe Mount available as an accessory
- Made in the USA



MAGNET MOUNT BASE

LED300 Specifications	
Lens Color	Amber, Blue, White, Green, Red
Operating Voltage	12-48 Volts, DC
Amps	200mA to 700mA @ 12 Volts, DC
Flash Patterns	8 Flash Patterns including Steady, HexaFlash, PentaFlash, Quad, Double, Day/Night mode and more. (Additional Flash Patterns can be added)
Flashes Per Minute (FPM)	120-360 Range (Varies per mode)
Lumen Output	300
LED Count	4 High Intensity LEDs
Base Diameter	5.2 inches
Overall Height	4.4 inches
Mounting	Standard - 3 hole flange with three 12 in. wire pigtails; Magnet - Combination 3 hole flange with 40 lb pull magnet mount including 15 ft straight cord and 2-way switch power plug. 1/2 in. NPT Pipe mount kit sold separately.
Approval	Independent Lab Certified SAE-J845 Class III
Temperature Range	-60° F to 140° F (-50° C to 60° C)
Warranty	5 Year



Durable materials used to withstand the harsh weather and working conditions frequently experienced in industrial applications

Easy twist-on dome made from UV-stabilized polycarbonate for increased visibility

Electronics are potted in epoxy, which protects against vibrations, dust, and water - the leading cause of failure



Optional 1/2 in. NPT Pipe Mount Kit



2-Way Switch Power Plug



3 Hole Flange with three 12 inch wire pigtails



Optional Neodymium anti-scratch magnets with superior holding power

15 ft. straight cord and 2-way switch power plug

HEAVY DUTY LED2250 BEACONS

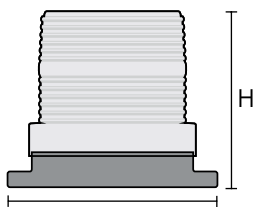

Model	Description	Lumens	Diameter	Height	Prop 65
SL.300.M*	LED Beacon Class III with Magnet Mount (Combination 3 hole flange with 40 lb pull magnet mount, including 15 ft straight cord and 2-way switch power plug)	300	5.2 in. (13.2 cm)	4.4 in. (11.2 cm)	⚠
SL.300.S*	LED Beacon Class III with Standard Mount (3 hole flange with three 12 in. wire pigtails)	300	5.2 in. (13.2 cm)	4.4 in. (11.2 cm)	⚠
PIPEMOUNT300	Optional 1/2 in. NPT Pipe Mount for the LED300 LED Beacon only				-

⚠ WARNING: Cancer and Reproductive Harm - www.P65Warnings.ca.gov

Eagle Eye 1.0

Put an end to bogus claims - Record every vehicle in and out of your facility in high definition
Improve customer service - Listen to every conversation that your staff is having with the client
This Parking Pro Shop systems will quickly pay for itself

- 8ch 4TB HD 1080P DVR
- (4) HD 1080P, 2.8-12mm Varifocal (manual zoom) Lens, Vandal Dome Camera
- (4) HD 1080P, Fixed Lens, Vandal Dome Camera
- (1) Microphone for live listening and play back
- (1) Security box for DVR
- (1) Wall brackets for security box
- (1) LCD Screen with built in speakers
- (1000ft) Copper core wire
- (1) 9ch 10A power supply
- Video connectors and power connectors included



\$2,038.99

Eagle Eye 2.0

For Larger Operations (2 or more entrance lanes)
Put an end to bogus claims - Record every vehicle on way in and out in high definition
Improve customer service - Listen to every conversation that your staff is having with the client
This Parking Pro Shop system will quickly pay for itself

- 16ch 4TB HD 1080P DVR
- (8) HD 1080P, 2.8-12mm Varifocal (manual zoom) Lens, Vandal Dome Camera
- (8) HD 1080P, Fixed Lens, Vandal Dome Camera
- (1) Microphone for live listening and play back
- (1) Security box for DVR
- (1) Wall brackets for security box
- (1) LCD Screen with built in speakers
- (2000ft) Copper core wire
- (1) 18ch 20A power supply
- Video connectors and power connectors included



\$3,598.99

Call to Order **516-825-0727**
Or Visit Us On-Line
Parkingproshop.com
Bulk Pricing Available



SURGICAL MASK

(3 PLY) LEVEL 3

- 4 PLY, 3 PLY
- Level 3
- Case of 50
- Easy to breathe
- Prevents dust and bacteria

\$17.99

Case of 50

3 PLY

FACE COVERS

This budget-friendly, single-ply face covering is breathable, comfortable and designed to cover the wearer's nose and mouth. Earhole slots offer a customized fit.

- 240 units per pack
- Available to ship today
- Black or Navy
- 1 ply 50/50 blend
- Ultra breathable
- size adjustment

Only

\$192.00



Bioprotect™ Hydrating Hand Sanitizer

BIOPROTECT™ hand sanitizer is a unique hand sanitizer that moisturizes and hydrates your hands as it cleans away surface germs and bacteria.

- Provides up to 6 hours of extended hand protection
- Kills 99.99% of germs and bacteria on hands
- Water based, Alcohol free, Paraban free, Sulfate free formula
- Aloe Vera infused for hydration

Case of 24	\$49.99
Case of 96	\$179.99
Case of four 1 Gallon units	\$129.99
One 5 Gallon unit	\$129.99

Call to Order **516-825-0727**
Or Visit Us On-Line
Parkingproshop.com
Bulk Pricing Available

Dispenser



Dispenser

- High quality
- Top Fill
- 33.8oz
- Dimensions
5.11"x4.72"x10.82"

Only **\$10.99**

buy 5 or more get 10% off

**BUY 1 GAL CASE OF 4 OR 5 GAL HAND
SANITIZER GET FREE DISPENSER**

GLOBAL VIRUS
NETWORK STUDY
FOR SARS-COV-2



BIOPROTECT™ RTU

- Ready to use, water based antimicrobial surface protectant
- Remains active on applied surfaces for up to 90 days
- Non-leaching & non-migrating

5 Gal **\$199.99**

Become a Distributor

Call to Order **516-825-0727**
Or Visit Us On-Line
Parkingproshop.com
Bulk Pricing Available





SmartTouch Disinfectant

Disinfect using SmartTouch®, hospital grade disinfectant.

- EPA registered
- NSF registered D2 sanitizer on food contact surfaces
- Kills 99.999% of bacteria in less than 60 seconds

5 Gal **\$129.99**

Become a Distributor

Hand Dryer and Accessories



Black

\$260.00

ALP405-10-BLA



Chrome

\$260.00

ALP405-10-CHR



Coffee

\$260.00

ALP405-10-COP



Gray

\$260.00

ALP405-10-GRY



White

\$260.00

ALP405-10-WHI

REPLACEMENT HEPA FILTER

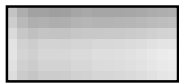

**Brushed
Stainless Steel**

\$260.00

ALP405-10-SSB



\$24.00

ALP405-FILTER

WILLOW HIGH-SPEED ELECTRIC HAND DRYER

- 8 second drying time
- Equipped with heat and speed controls
- Contains replaceable HEPA filter
- ADA compliant without recess kit
- 5-year limited warrant

**BRUSHED
STAINLESS STEEL**

Horizontal baby changing stations



- Meets global ADA, FDA, and ASTM safety standards
- 2 liner dispensers, liners not included
- Safety belt securely holds the child in place
- 2 side hooks for hanging diaper bag and personal items

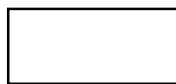

\$260.00

ALP411 White



\$260.00

ALP411-GRY Gray



\$260.00

ALP411-SSB

Call to Order **516-825-0727**
Or Visit Us On-Line
Parkingproshop.com
Bulk Pricing Available

Paper Towel Dispensers / Holders



RECESSED PAPER TOWEL DISPENSER WASTE RECEPTACLE

- Holds up to 600 C-fold or 800 multifold towels
- 12 Gallon Waste Capacity
- Keeps restrooms clean with space-saving efficiency

\$396.00

ALP492

**BRUSHED
STAINLESS STEEL**



**2 GALLON WASTE
RECEPTACLE
CAPACITY**

RECESSED PAPER TOWEL DISPENSER WASTE RECEPTACLE

- Holds up to 350 C-fold or 475 multifold paper towels
- Keeps restrooms clean with recessed space-saving efficiency
- 2 Gallon Waste Capacity

\$205.00

ALP492

**BRUSHED
STAINLESS STEEL**

Soap/Sanitizer Dispensers



AUTOMATIC HANDS-FREE BULK SOAP/SANITIZER DISPENSER

- Sleek floor stand allows you to use this dispenser anywhere

Black

\$92.00

ALP430-F-S-BLK



STAND WITH DRIP TRAY FOR HAND SANITIZER/SOAP DISPENSERS

- Durable powder-coated black metal construction
- Universally designed for most soap/sanitizer dispensers
- Conveniently place anywhere

Black

\$59.00

ALP430-STAND-BLK

Toilet Seat covers and dispensers



PLASTIC TOILET SEAT COVER DISPENSER

- Dispense covers one at a time

\$12.50

ALP453



250 SHEETS/SLEEVE TOILET SEAT COVERS

- Flushable and biodegradable.
- 250 sheets/sleeve

3 Pack

\$9.50

ALPP400 3 Pack

20 Pack

\$75.00

ALPP400-C



**BRUSHED
STAINLESS STEEL**

STAINLESS STEEL TOILET SEAT COVER DISPENSER

- Dispense covers one at a time

\$34.00

ALP483

Call to Order **516-825-0727**
Or Visit Us On-Line
Parkingproshop.com
Bulk Pricing Available

Outdoor trash cans - With ashtray Lid



OUTDOOR DECORATIVE STEEL TRASH CANS

- Domed top keeps rain out
- Includes removable leakproof plastic trash liner
- Lockable lid
- Opens easily to remove trash.



ALP471 - 40
replacement key

ALP472-40 – STO

\$597.00

Stone Panel

ALP472-40 – SIL

\$597.00

Silver Panel

ALP472-40 – GRYS

\$597.00

Gray Panel

\$3.00

2 pack



OUTDOOR METAL SLATTED TRASH CAN

- For parks, offices, and city streets.
- Slatted steel bars deter vandalism
- Weather and rust-resistant, powder-coated finish
- Includes black liner

ALP479-38

\$634.00

flat

ALP479-38-1

\$735.00

bonnet

ALP479-38- A

\$125.00

Bonnet lid



CORRUGATED PLASTIC RECYCLING STATION

- Lightweight and portable
- Decals included: glass, plastic, paper, recyclables, cans, and waste
- 12-inch round deposit opening
- Ships KD

ALP471-02-BLK (2 bin)

\$65.00

ALP471-03-BLK (3 bin)

\$80.00

Call to Order **516-825-0727**

Or Visit Us On-Line

Parkingproshop.com

Bulk Pricing Available

Wipes and Dispenser

Wipes dispenser



WALL-MOUNTABLE STAINLESS STEEL LARGE ROLL WET WIPE DISPENSER

- 0" x 10" white plastic bucket included
- Holds up to an 800-wipe roll
- Space-saving design



WALL-MOUNT

ALP4777 – stainless steel

\$241.00



BUCKET
INCLUDED

ALP477 – black

\$253.00



EASY TO
REFILL

Janitorial

Umbrella accessories



ALP489

\$65.00

UMBRELLA STAND

- Reduces housekeeping maintenance and labor from rainy day mop-ups
- Built-in sign frame for customizing your own messages
- Umbrella bag comes with handles for an easy carry



UMBRELLA BAGS

- Equipped with an easy carry handle on each bag

ALP489-100

\$13.00

ALP489-TOU

\$68.00

Call to Order **516-825-0727**
Or Visit Us On-Line
Parkingproshop.com
Bulk Pricing Available

Urinal Screen

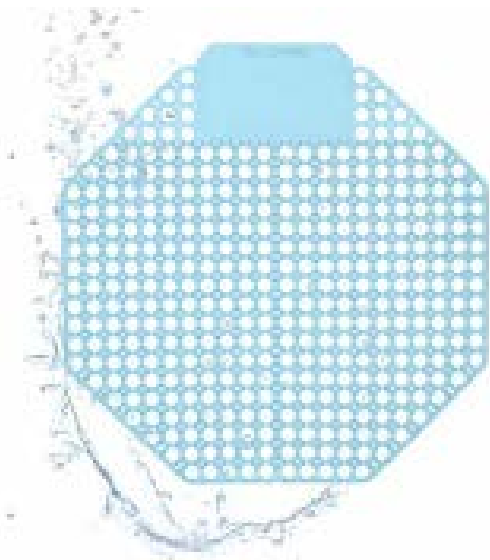

OCEAN MIST

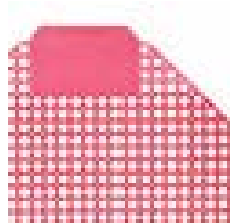

SPICED APPLE

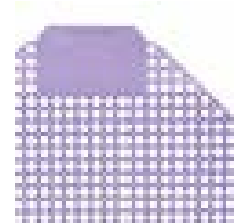

KIWI GRAPEFRUIT

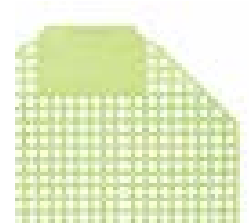

CUCUMBER MELON

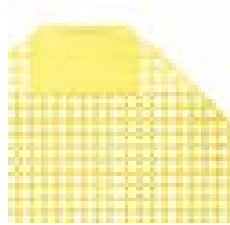

MANGO



CHERRY

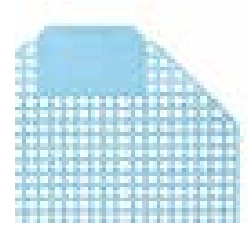

COTTON BLOSSOM

ELUXE URINAL SCREEN

- 10x more fragrant than vinyl screens. Deodorizes up to 30 days
- Efficiently eliminates 99% of splashback and averts clogging
- Flexible 8-sided design snugly fits any urinal configuration
- Shipped in packages of 10 individually packaged screens
- Dual-sided, position it in any way

\$22.50

ALP4111-SA Spiced Apple

\$22.50

ALP4111-MANGO Mango

\$22.50

ALP4111-CM Cucumber Melon

\$22.50

ALP4111-CB Cotton Blossom

\$22.50

ALP4111-OM Ocean Mist

\$22.50

ALP4111-KG Kiwi Grapefruit

\$22.50

ALP4111-CHERRY Cherry

Storage and Shelving

Safes



DIGITAL DEPOSITORY SAFE

- Programmable digital keypad lock
- Drop slot bin door
- Backup key included
- Carpeted interior to protect valuables

Black

\$298.00

ADI670-200-BLK

Key Cabinets



**HOLDS
100 SETS
OF KEYS**



**HOLDS
200 SETS
OF KEYS**



HEAVY-DUTY KEY CABINETS WITH DUAL DIGITAL/KEYED LOCK

- Key hooks and tags included
- Combination lock with over 1,000 re-settable combinations
- Dual key, combination lock
- Color-coded, numbered key hook bars

\$133.00

ADI683-100-blk

\$189.00

ADI683-200-white

BOTH INCLUDE:



**COLOR-CODED
Hooks**



**COLOR-CODED
TAGS**

Call to Order **516-825-0727**
Or Visit Us On-Line
Parkingproshop.com
Bulk Pricing Available



Storage and Shelving

Magazine Racks

ADI640-2023-CLR



ADI640-2923-CLR



ADI640-3020-CLR



ADI640-2935-BLK



ADI640-2948-BLK



ADI640-5110-BLK



ADI640-5120-BLK



HEAVY-DUTY KEY CABINETS WITH DUAL DIGITAL/KEYED LOCK

- Accommodates 8.5 x 11 magazines and slim 4 x 9 brochures
- Adjustable pockets are customizable to hold both magazines and brochures
- Clear acrylic for easy viewing

ADI640-2023-BLK – 8 slots

\$82.00

ADI640-2023-CLR – 8 slots

\$82.00

ADI640-2923-BLK – 12 slots

\$120.00

ADI640-2923-CLR – 12 slots

\$120.00

ADI640-3020-BLK -12 slots

\$103.00

ADI640-3020-CLR – 12 slots

\$111.00

ADI640-2935-BLK -18 slots

\$164.00

ADI640-2935-CLR – 18 slots

\$164.00

ADI640-5110-BLK – 20 slots

\$200.00

ADI640-5110-CLR – 20 slots

\$200.00

ADI640-2948-BLK – 24 slots

\$202.00

ADI640-2948-CLR – 24 slots

\$202.00

ADI640-5120-BLK – 48 slots

\$347.00

ADI640-5120-CLR – 48 slots

\$347.00

Car Cover



Water Calcium Damage Protector

Need a temporary protection for your vehicle's exterior. We have the best disposable vehicle cover for you. "Parking ProShop Water Calcium Protector Cover" are made of environmental friendly light-weight plastic, protects against dirt, dust, paint and its water resistant. Be penny wise with our disposable covers.

- This cover fits cars up to 264" in length
- Protects against water damage, dust, dirt and more
- Light weight

Case of 20	\$259.00
------------	----------

Call to Order **516-825-0727**
Or Visit Us On-Line
Parkingproshop.com
Bulk Pricing Available



Parking Maintenance services



Power Washing



Scrubbing



Sealcoat

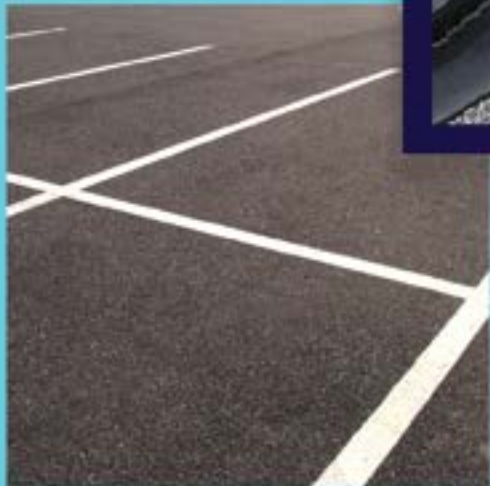

Striping



Sweeping

**FREE
ESTIMATES**

Paint and Epoxy

Paint



5 Gal	\$180.74
1 Gal	\$36.15

5 Gal	\$138.90
1 Gal	\$27.18

5 Gal	\$103.86
1 Gal	\$20.37

5 Gal	\$174.13
1 Gal	\$34.13



5 Gal	\$98.63
1 Gal	\$19.53

5 Gal	\$87.64
1 Gal	\$19.33

5 Gal	\$87.64
1 Gal	\$19.33

5 Gal	\$138.90
1 Gal	\$27.18

Epoxy



5 Gal	\$273.00
-------	----------

5 Gal	\$358.95
-------	----------

5 Gal	\$303.50
-------	----------



Large Color Stock

Non Slip Coating



5 Gal	\$358.95
-------	----------

Textured Non-Slip in 2 colors safety YELLOW and BATTLESHIP GRAY.

A decorative, chemically resistant product that is excellent for use as an anti slip safety coating in high traffic areas



Call to Order **516-825-0727**
 Or Visit Us On-Line
Parkingproshop.com
 Bulk Pricing Available



Just Tip And Roll



Starting at

\$238

- Perfect for commercial and residential parking facilities
- 72lb base
- 18" wide
- 2" post



Sign Conversion

Upgrade your signage to the latest technology
Parking ProShop makes light box conversion fast and easy

Save on utility bills

Improve brand appearance

Improve life span

Go green

Before



After



Call to Order **516-825-0727**
Or Visit Us On-Line
Parkingproshop.com
Bulk Pricing Available



Calcium Chloride Pellets



Calcium Chloride

- Pellets 50lb bag
- 55 Bag pallets
- Fast shipping
- Peladown brand

(CALCP50)

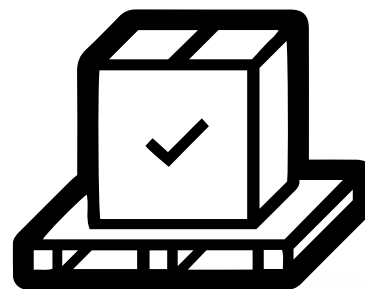

Call for a quote today!!!



Spill Kit



\$74.99

Call to Order **516-825-0727**
Or Visit Us On-Line
Parkingproshop.com
Bulk Pricing Available

P PARKING
PROSHOP.COM
516-825-0727



Car Charging



Achieve high velocity airflow in an ultra compact design The XPOWER P-130A offers up to 800 CFM with its high efficiency 1/5 HP motor. Drawing only 2 Amps at its highest speed, this multipurpose air mover is a household must have Great for cooling your garage or drying carpets, leaks, and spills – the P-130A's wide pattern of airflow allows you to dry and ventilate like a pro at a fraction of the cost.

- Wide pattern of airflow- great for cooling your garage and home or drying carpets, leaks, and spills
- Compact size fits to tight spaces to direct airflow inside auto interiors, under counters, and more
- Lightweight, compact and durable polypropylene (PP) plastic housing design
- Built-in power outlets for daisy chain with dual thermal protection
- 3 speeds with 4-angle drying positions (0°, 20° kickstand, 45° and 90°)
- Powerful and energy efficient 1/5 HP induction motor
- Low 2 Amps draw with 700 CFM airflow capacity
- Convenience Grab-N-Go handle and wrap-around power cord design
- Stackable up to 4 units high for easy storage and transportation
- ETL/CETL safety certified and meet OSHA safety requirements
- Xactimate code for professional water damage estimates: WTRDRY-
- HEIGHT INCHES 12
- COLOR FINISH **Yellow**
- BRAND **XPower**
- CFM **800**
- CONSTRUCTION **Plastic**
- DESCRIPTION **Air Mover W/ Daisy Chain**
- HORSEPOWER **1/5**
- MANUFACTURERS PART NUMBER **P-130A**
- POWER CORD LENGTH **10'**
- SPEED **3**
- TYPE **Air Mover**
- VOLTAGE **115**
- WATTAGE **230**
- WEIGHT LBS **12**
- WIDTH INCHES **11**
- RPM **1500**
- HERTZ **60**
- AMPS **2**
- DEPTH INCHES **12-4/5**

pressure washers



The Simpson® MegaShot Series is perfect for the “Do-it-Yourselfer” looking for maximum performance with minimal investment. Simple to use and great for cleaning decks, patios, outdoor furniture, house siding, and prepping home exteriors for painting. Its compact design is lightweight and small enough to be easily transported by one person. Equipped with a premium Honda® engine built with high-quality components, designed for optimum performance and renowned for being easy to start.

- Honda® GCV160 engine is easy to start and operate
- Reliable, maintenance-free OEM Technologies™ axial cam pump with thermal relief
- MorFlex® 1/4” x 25’ the high-pressure hose is non-marring, flexible and abrasion-resistant
- Steel frame construction with a powder-coated finish for durability and corrosion resistance
- 12” never-flat wheels for ease of maneuverability across various terrain
- 4 quick connect nozzle tips include 0°, 15°, 40° and soap to use for a variety of cleaning applications
- The actual product may vary slightly from product images
- This product has limited consumer warranty of 2 and 1 years on engine and pump respectively, along with 5 year limited consumer warranty on frame and 90 day limited warranty on accessories

- BRAND **Simpson**
- HORSE POWER --
- MANUFACTURERS PART NUMBER **60784**
- MAXIMUM PSI **2800**
- TYPE Pressure **Washer**
- WEIGHT LBS **57**
- ENGINE/MOTOR TYPE **Gas**
- PUMP TYPE **Axial Cam**
- HOSE ID INCHES **1/4**
- WHEEL TYPE **Never-Flat**
- WHEEL DIAMETER INCHES **12**
- MAXIMUM GALLONS PER MINUTE **2.3**
- ENGINE BRAND **Honda**
- PUMP BRAND/OEM **Technologies**
- ELECTRIC START **No**
- DRIVE **Direct**
- SERIES **MegaShot**
- CA COMPLIANT **Yes**
- MANUFACTURER LIMITED WARRANTY YEARS (ENGINE) **2**
- MANUFACTURER LIMITED WARRANTY YEARS (PUMP) **1**
- STATIONARY OR MOBILE **Mobile**
- WATER TYPE **Cold**
- HOSE LENGTH (FEET) **25**
- THERMAL RELIEF VALVE **Yes**
- ENGINE SERIES/GCV **160**
- ENGINE DISPLACEMENT(CC) **160**

Call to Order **516-825-0727**
Or Visit Us On-Line
Parkingproshop.com
Bulk Pricing Available

Snow Blowers



- Powered by a dependable 243cc 4-Cycle Electric Start OHV gas engine with 6 forward and 2 reverse speeds for optimal control while operating
- Clears snowy walkways up to 26 inches wide and 21 inches deep in one pass and equipped with deluxe reversible skid shoes for more control
- Equipped with an extended 2-way manual discharge chute that propels snow farther away from you before the wind can catch it
- Durable 15 x 5-inch airless tires provide good traction in snowy conditions
- Equipped with Just One Hand operation that allows you to adjust the 200 degree chute direction control without stopping

\$1995.00

- **Powerful Engine Performance:** 212cc PowerSmart engine offers powerful snow-clearing action, 24 inch clearing width keeps you blasting snow and throwing it up to 40 feet.
- **Dual-Stage Snow Blower:** powerful auger cuts through tough snow and diverts it away from the chute to prevent clogging and keeps snow blowing stay the course.
- **Snow Blower Capability:** allows a snow clearing width of 24 in. and a clearing depth of 20 in. clear driveways that can hold 10 parked cars and 6 in.-10 in. of snow.
- **Self-Propelled System:** easily cut through snow with speed control, 6 forward and 2 reverse speeds for enhanced driving convenience.
- **Corded Electric Starter & Recoil Pull Starter:** corded to household power, push button electric start; or just pull to start in a snap. 13 in. inflatable tires deep snow tread bites into slippery terrain, ideal for concrete, asphalt and gravel surfaces.

\$1295.00

- High capacity belt system for extra capability in heavy snow
- 4 steps height adjustable handle for ergonomic operation
- The option of disconnecting the differential lock and choosing which wheel/track should drive (power steering) makes the machine easy to maneuver and operate
- The robust and durable auger housing gives sturdy operation, efficient snow clearing and long product lifetime
- The robust auger gives first-class results operating in frozen as well as in extremely wet snow
- Heavy-duty auger gearbox for maximum durability (10-year warranty)
- The impeller has four blades, which is unique on the market! The cast iron ensures maximum durability

\$3195.00

Safe Smoker & Butt Cans



1206 BLACK
5 qt. /4.7 L
in: 15 1/4 x 37 3/4
cm: 38.8 x 95.9

1208 BLACK
4 gal./15.2 L
in: 17 1/4 x 43 1/4
cm: 43.8 x 109.9

1213 BLACK
2 gal./7.58 L
in: 12 1/2 x 37
cm: 31.8 x 94

SAFESMOKERTM Cigarette Receptacle

is made of high-density polyethylene with UV inhibitors, with a galvanized steel collection bucket inside. Design restricts oxygen to quickly extinguish burning butts. Top of container removes easily to access and empty internal bucket. Rain-protective design keeps water out and eliminates odor. Includes integrated hold-down tabs for security and wind protection.

Eagle Butt Cans

are ideal for "designated smoking areas" inside or outside. Features poly tube and galvanized can base. Yellow for in-plant use and beige for office or commercial areas.

Original Butt Cans

This all-metal galvanized steel can is excellent for smoking areas in industrial settings. 5-gallon (18.9 L) capacity in yellow or beige..



1206BEIGE	5 Quart	SafeSmoker Receptacle - Poly w/Metal Bucket-Beige	7 lb	\$103.00
1206GRAY	5 Quart	SafeSmoker Receptacle - Poly w/Metal Bucket-Gray	7 lb	\$103.00
1206BLACK	5 Quart	SafeSmoker Receptacle - Poly w/Metal Bucket-Black	7 lb	\$103.00
1206BROWN	5 Quart	SafeSmoker Receptacle - Poly w/Metal Bucket-Brown	7 lb	\$103.00
1208BEIGE	4 Gal.	SafeSmoker Receptacle - Poly w/Metal Bucket-Beige	10 lb	\$117.00
1208GRAY	4 Gal.	SafeSmoker Receptacle - Poly w/Metal Bucket-Gray	10 lb	\$117.00
1208BLACK	4 Gal.	SafeSmoker Receptacle - Poly w/Metal Bucket-Black	10 lb	\$117.00
1208BROWN	4 Gal.	SafeSmoker Receptacle - Poly w/Metal Bucket-Brown	10 lb	\$117.00
1202BEIGE/BLACK	2 Gal	Metal/Poly Butt Cans	5 lb	\$78.00
1205BEIGE/BLACK	5 Gal	Metal/Poly Butt Cans	7 lb	\$102.00
1200YELLOW	5 Gal	Original Butt Can	7 lb	\$108.00
1212BLACK	2 GAL	SafeSmokerTM-Hitching Post	18 lb	\$180.00
1213BLACK	2 GAL	SafeSmokerTM-Classic	18 lb	\$180.00

Call to Order **516-825-0727**
Or Visit Us On-Line
Parkingproshop.com
Bulk Pricing Available



Bird and Rodent Control



Plastic Spikes

- Repel birds 24/7
- Easy to install
- Material won't corrode or decay

Pigeons, Sparrows, Starlings, Crows, Blackbirds, Grackles and Swallows

RPS-10	10'	\$22.99
RPS-25	25'	\$58.99
RPS-50	50'	\$117.99
RPS-100	100'	\$232.99

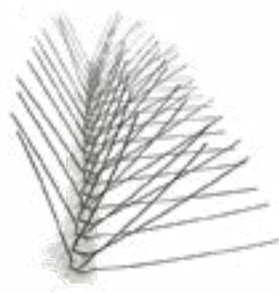

Stainless Spikes

- Repel birds 24/7
- Easy to install
- Material won't corrode or decay

Pigeons, Sparrows, Starlings, Crows, Blackbirds, Grackles and Swallows

STS-10	10'	\$34.99
STS-24	24'	\$88.99
STS-50	50'	\$174.99
STS-100	100'	\$340.99



Owl Decoy

- Accurate plumage
 - Intimidating, glassy eyes "follow" pests
 - 4-foot flexible wingspan
- Pigeons, Sparrows, Starlings, Crows, Blackbirds, Grackles and Swallows

1-5	\$32.99
6-19	\$28.99
20+	\$26.99



Bird Gel

- Applies easily to any ledge or landing
 - Effective for up to a year
 - Birds stop returning
- Pigeons, Sparrows, Starlings, Crows, Blackbirds, Grackles and Swallows

1-11	\$8.99
Box of 12	\$94.99



QB4110V

Quad Blaster

- Ultrasonic repeller
- Designed for use indoors
- Easy to install,
- Covers up to 6,500 sq. ft.

1-3	\$667.99
4+	\$646.99



Indoor Laser 110V

Bird-x Lazer

- State-of-the-art laser technology
- Works day and night
- Effective coverage up
- Silent, Humane, and Extremely Effective

1-3	\$496.99
4+	\$442.99



BB-PRO 110V

Broadband Pro

- SONIC and ULTRASONIC Technology
 - 4 independent speakers with 100 ft. of wire
- SONIC: covers up to 6 acres
ULTRASONIC: covers up to 3,600 sq. ft.

1-3	\$838.99
4+	\$802.99



TX-PRO

Broadband Pro

- SONIC and ULTRASONIC Technology
 - Covers up to 3,500 sq. ft.
- Rats, Mice, Bats, Chipmunks, Squirrels, Racoons, Ticks, Cockroaches, Spiders, Ants & other insects

1-3	\$82.99
4+	\$58.99

Stencils

Poly-Vinyl Stencil SAFETY STENCILS

- LARGE 22" DIAMETER
- WORDS & GRAPHICS
- KEEP EMPLOYEES ALERT

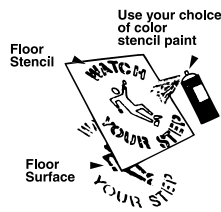

- Provide a permanent safety awareness message for employees
- Constructed of durable plastic for use over and over again



SF-1



SF-2



SF-3



SF-4



SF-9



SF-10



SF-11



SF-12



SF-5



SF-6



SF-7



SF-8



SF-13

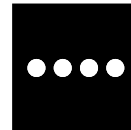

SF-14

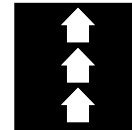

SF-15



SF-16



SF-17



SF-18



SF-19

ITEM #10

SAVE • TIME • MONEY • CLEAN UP

Constructed of 1/16" poly-vinyl material, these 22" round safety floor marking stencils provide your company with a unique method of warning employees about hazards in the workplace. Use spray stencil paint and permanently apply messages on floor, walls, or wherever you feel a warning is necessary. Just place the safety marking stencils on the area that you would like to apply the message—and paint!

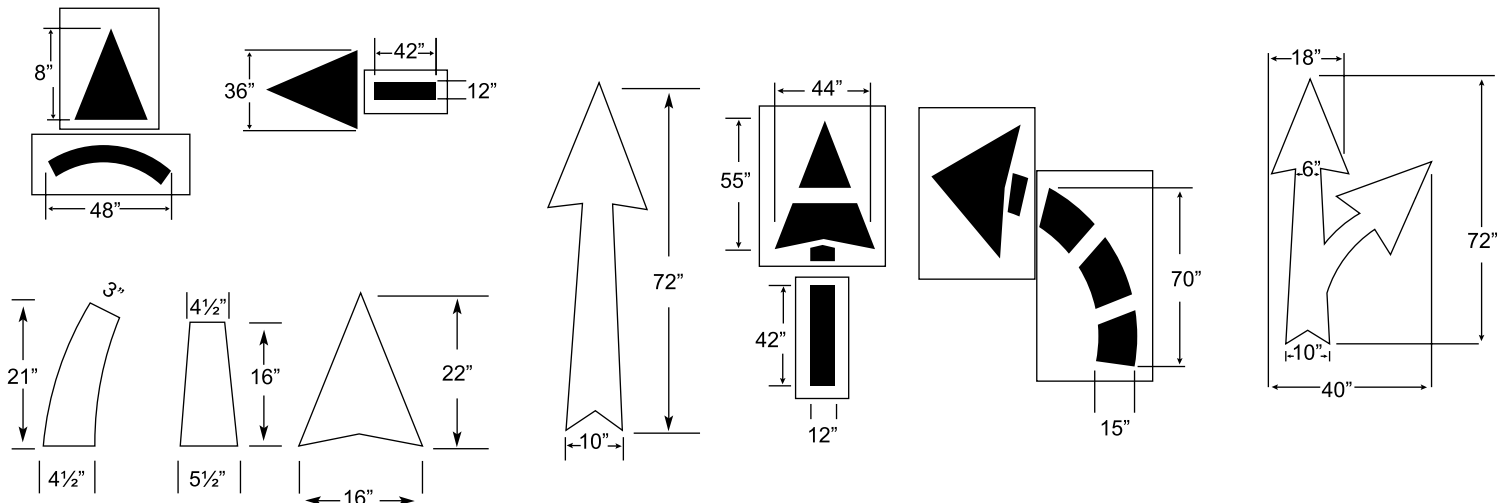

Call to Order **516-825-0727**
 Or Visit Us On-Line
Parkingproshop.com
 Bulk Pricing Available



Stencils

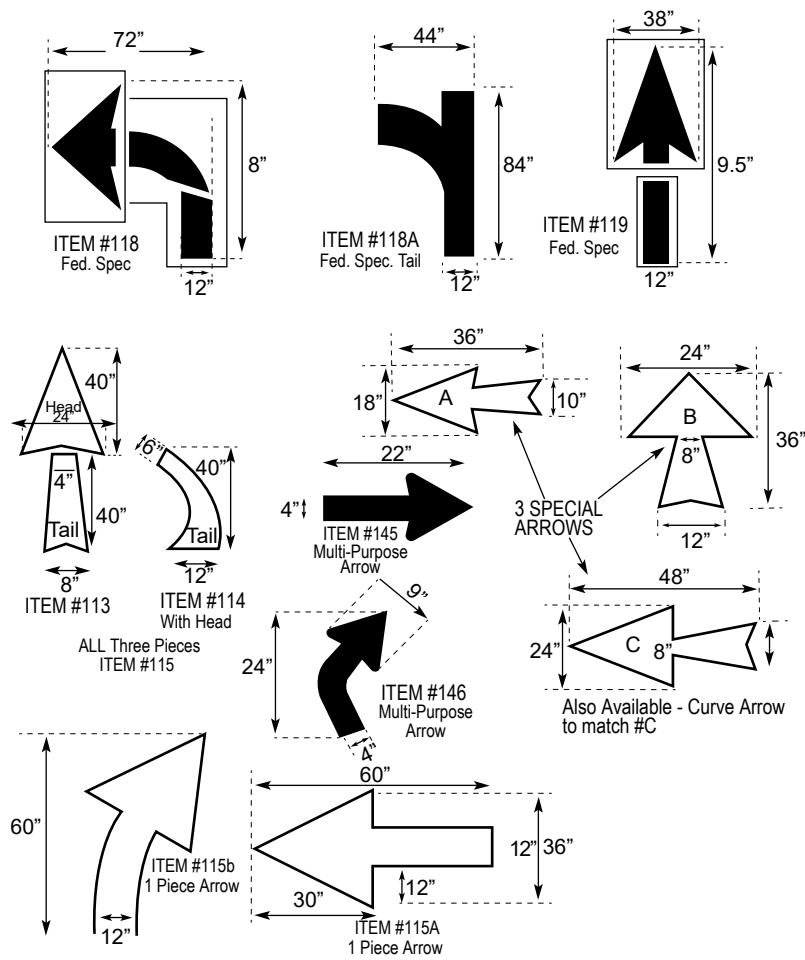

24"x72" & 36"x72"



Crosswalk Bar
ITEM #230

4"x144"



Line Stencil
ITEM #231

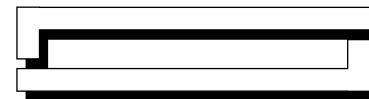

Wheel Stop Overspray



California Loop
ITEM #232



ALUMINUM
CANS ONLY

PAPER ONLY

PLASTIC ONLY

GLASS ONLY

WASTE ONLY

ITEMS #234/235/236/237

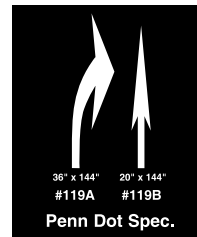

ITEMS #119A & 119B



ITEM #215

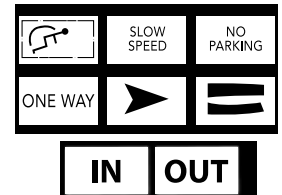

1 set 8" 0 to 9 & 1 set 8" A to Z

ITEM #238

*1/16" Poly

Outline Arrows

LEAVES A 4" WIDE OUTLINED ARROW

ITEM #119H

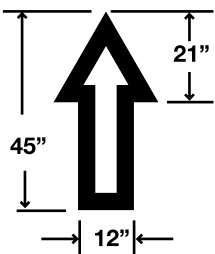

ITEM #119I

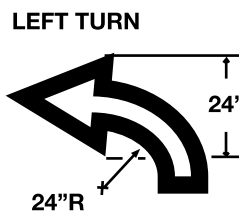
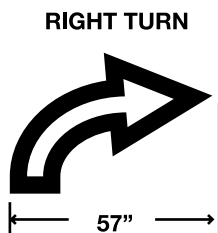

ITEM #119J

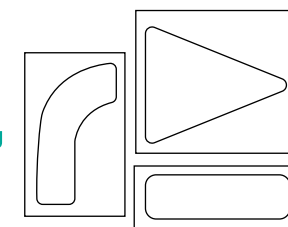

ITEM #119K

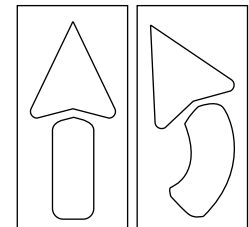

3 Pc. Arrow Kit
36" WIDE x 90" HIGH

2 Pc. Arrow Kit
20" WIDE x 42" HI H

Stencils

PARKING LOT ARROWS

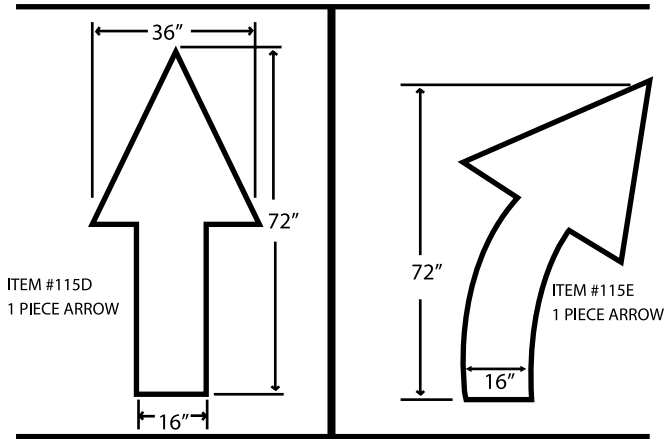

DOT BIKE LANE ARROW

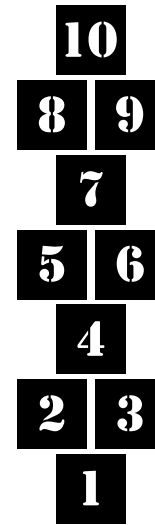
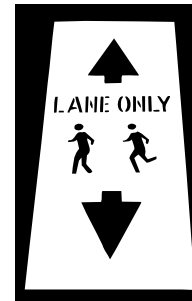
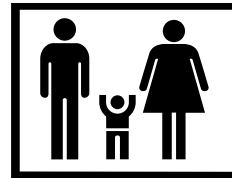
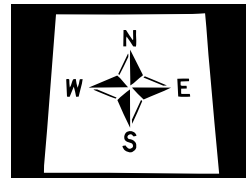
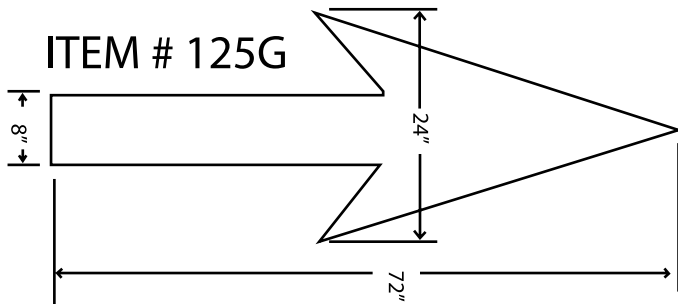

ITEM #125C

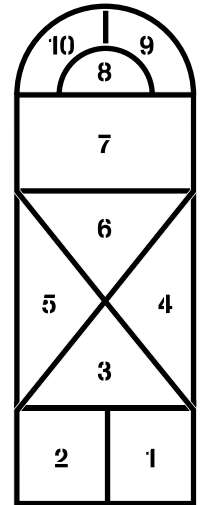

ITEM #216

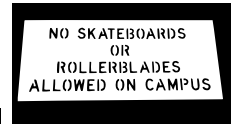

BABY & CARRIAGE
32"W x 36 "H



ITEM #215B

BABY & STORK
45"W x 24 "H



ITEM #215A

NO PARKING SYMBOL
26" DIAMETER



ITEM #239A

GOLF CART
36"W x 28 "H



ITEM #214A

ROLLER BLADING
IN-LINE SKATING
16"W x 20 "H



ITEM #214B

NO SKATEBOARDS
26" DIAMETER



ITEM #239B

Call to Order **516-825-0727**
Or Visit Us On-Line
Parkingproshop.com
Bulk Pricing Available



FULL LETTER & NUMBER KITS

ITEM NO.	ITEM DESCRIPTION	
98-FA	4" Letters A-Z	\$65.50
99-FN	4" Numbers 0-9	\$32.20
100-FA	6" Letters A-Z	\$81.90
01-FN	6" Numbers 0-9	\$39.20
101A-FA	8" Letters A-Z	\$114.66
101B-FN	8" Numbers 0-9	\$63.00
102-FN	10" Numbers 0-9	\$69.30
102A-FA	10" Letters A-Z	\$161.00
103-FN	12" Numbers 0-9	\$77.00
104-FA	12" Letters A-Z	\$196.00
104B-FN	18" Numbers 0-9	\$133.00
104A-FA	18" Letters A-Z	\$357.00
105-FN	24" Numbers 0-9	\$147.00
106-FA	24" Letters A-Z	\$406.00
107-FA	36" Letters A-Z	\$588.00
107A-FN	36" Numbers 0-9	\$245.00
108A-FA	48" Letters A-Z	\$837.00
108-FN	48" Numbers 0-9	\$322.00
109FA	72" Letters A-Z	\$837.00
109A-FN	72" Numbers 0-9	\$322.00
110A-FA	96" Letters A-Z	\$1512.00
110C-FN	96" Numbers 0-9	\$581.00

FEDERAL LANE REDUCTION ARROW 18' LONG x 5 '6" WIDE



ITEM #119M

FEDERAL U-TURN ARROW

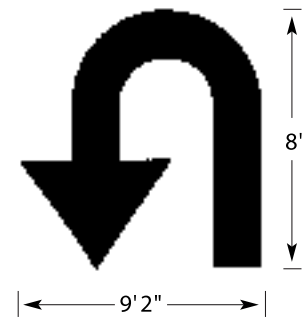

ITEM #119L

3 PIECE ARROW KIT

37" Straight Arrow 43" Curve Arrow



ITEM #115C

Stencils

Railroad

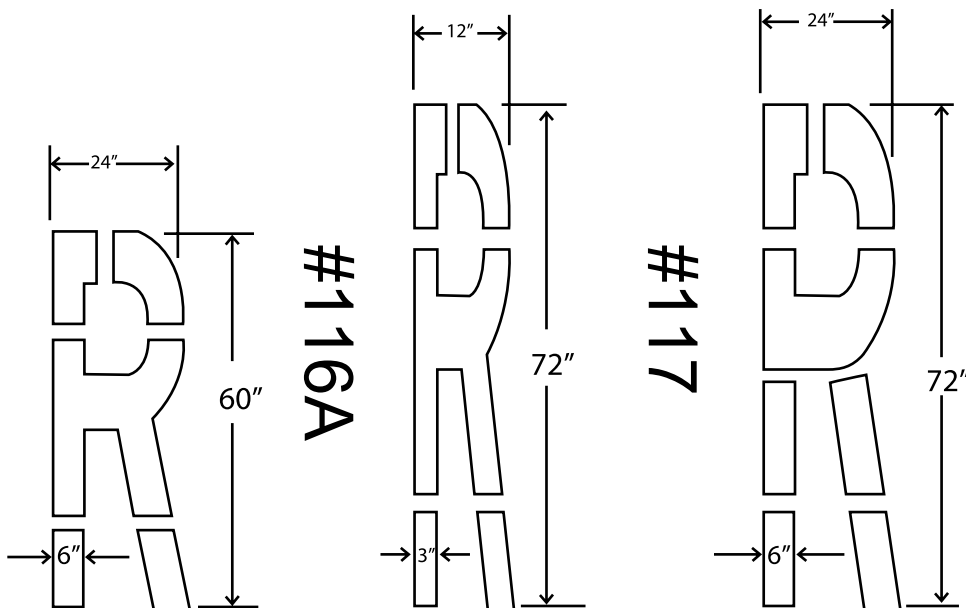

Yield Line

ITEM #215C

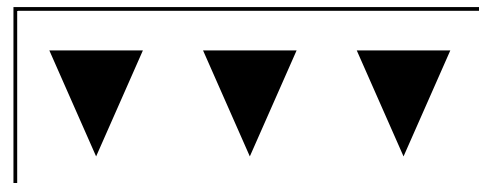

SPECIFY SIZE
AVAILABLE SIZES

12"x18"
16"x24"
24"x36"

(3 images on 1 stencil)

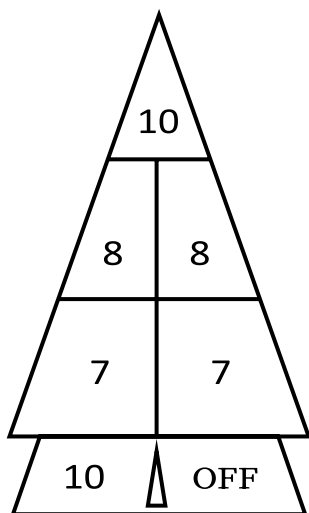

Shuffle Board

6'x10'x6"

ITEM #152C



21 Pc. Kit

ITEM #242

KIT INCLUDES:





- 8" VISITOR RESERVED 0-9
- 9" NO PARKING SLOW SPEED ONE WAY
- 18" STOP IN OUT
- HANDICAP SYMBOL w/BORDER
- 3 PC. ARROW KIT

*1/16" Poly

Call to Order **516-825-0727**
Or Visit Us On-Line
Parkingproshop.com
Bulk Pricing Available



Stencils

ITEM NO.	DESCRIPTION
275	Leaf w/Roadway 36" x 55" Low Emitting Fuels
276	Double Leaf 40" x 40" Low Emitting Fuel
277	60" S-T-O-P
278	3" 1pc., Stencils, 1/16" Poly NO, PARKING, FIRE, LANE, RESERVED, VISITOR, HANDICAPPED, HOUR, ALL, RATED, WALL, FOR, PLUS, NO EXIT, TOW, ZONE, ONLY, AWAY, PREMIUM, OPENING, KEROSENE, PERMIT, REGULAR
279	Circles for Playgrounds Available sizes 4" to 24" diameter 30" X & 30" ▲ (Also used for aerial surveys)
280	Crosswalk Awareness Symbol Available sizes 12" & 16" letters LOOK!
281	Electric Car or Parking Stalls 42" Diameter 
282	Ribbon 72" 
283	Charging Station or Parking Stalls 40" x 35" 
284	* Roman Gothic 9" 0 to 9 set 
	* Roman Gothic 9" Letters A to Z
285	Handicap Symbol w/Border 1 piece 3" Wide Border 42" Sq. 
286	36" Letters 1Pc. Stencils

 111E & F	 249	 2 - 060 or
 251	 252	 253
 254	 255	 256
 257	 258	 259
 260	 261	 262
 263	 264	 265
 266	 267	 268
 269	 270	 271
 272	 273	
 274	 275	 276

CLEAN UP! TRASH YOUR TRASH



ITEM #245

10"W 12 "H x

NO ROLLER SKATING



ITEM #246

26" DIAMETER

BIKE SHARED LANE
2-PIECE STENCIL



ITEM #247

40"W x 111 "H

BIKING AWARENESS



ITEM #248

20"W x 18 "H



Stick to Your Budget and Get Every Stencil You Need

STOCK ECONOMY PLASTIC STENCIL KIT

Kit includes the following plastic stencils:

- 9" letters (A-Z), 9" numbers (0-9)
- Words in 9" letters: SLOW SPEED, NO PARKING
- Words in 10" letters: ONE WAY
- Words in 19" letters: IN, OUT
- 22" x 15" arrowhead; 20" arrow stems
- 31" x 19" Disabled Access Symbol

ITEM #243

*1/16" Poly

Call to Order **516-825-0727**
Or Visit Us On-Line
Parkingproshop.com
Bulk Pricing Available



BRASS INTERLOCKING STENCIL KITS



GOTHIC style

Horizontal Composition

- Durable brass for long-lasting service.
- Clean with paint solvent.
- Quick, legible signs on all surfaces.
- Slide together and come apart easily.
- Use brush or spray ink, paint or use markers.

Numbers Only, Single Sets 15 Pieces As follows: 1234567890 1-Beginner, 1-Plain Ender 1-Dash, 1-Period	
Number	Size Description
10006	1/2"
10007	3/4"
10008	1"
10009	1"-1/2"
10011	2"
10012	2"-1/2"
10012	3"
10014	4"
10015	5"
10016	6"

Letters Only, Single Sets 33 Pieces as follows ABCDEFGHIJKLMNOPQRSTUVWXYZ& 1- Beginner, 1-Period Ender 1-Spacer, 1-Comma, 1-Dash, 1-Period	
Number	Size Description
10026	1/2"
10027	3/4"
10028	1"
10029	1"-1/2"
10031	2"
10032	2"-1/2"
10033	3"
10034	4"
10035	5"
10036	6"

Easy to Use One-Piece Stencils

9" HIGH LETTERS

**SLOW
SPEED**

ITEM #188A

9" HIGH LETTERS

**NO
PARKING**

ITEM #188B

4" HIGH LETTERS

**WAIT FOR
WALK SIGNAL**

ITEM #167B

6" HIGH LETTERS

STOP - LOOK

ITEM #146B

10" HIGH LETTERS

**ONE
WAY**

ITEM #142B

Wheel Stop Stencils

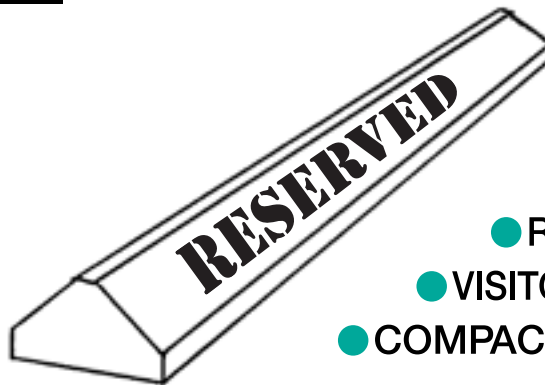

● 2³/₄" HIGH LETTERS

● HANDICAPPED

● RESERVED

● VISITOR

● COMPACT CARS

ITEM #239

*1/16" Poly

Fuel Identification/Environmental Stencils

ONE PIECE ALL 3" HIGH LETTERS

*1/16" Poly

VAPOR
RECOVERY

● REGULAR
PREMIUM

● KEROSENE
● PLUS

● DIESEL

ITEM #240

Parks and Recreation Stencils

3" HIGH LETTERS

*1/16" Poly

RESERVED

● VISITOR
ONLY

● NO PARKING

● HANDICAPPED

FIRE LANE

ITEM #241

Call to Order **516-825-0727**
Or Visit Us On-Line
Parkingproshop.com
Bulk Pricing Available





ITEM# 222 2 PIECE

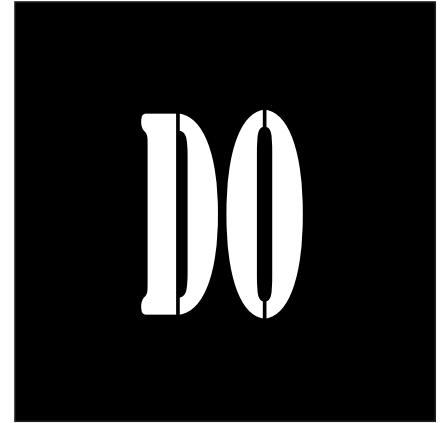

ITEM# 223



ITEM# 224

**48" HIGH
LETTERS**

**1 PIECE
& 2 PIECE
STENCILS**

**Made on
Durable
" Poly
Material**

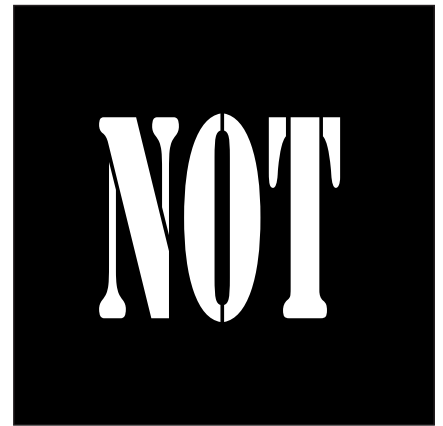

ITEM# 225



ITEM# 226

**Legends
48" High
Letters**

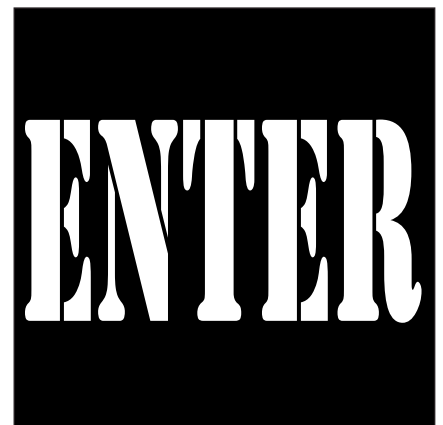

ITEM #227A 2 PIECE



1-844-787-7595
Parkingproshop.com