



S9013/S9023 BUYDEEM Water Dispenser

User's Manual



Shenzhen Crastal Technology Co.,Ltd.

Block7&8, D Industrial Zone, Buchong, Shajing, Bao'an,
Shenzhen City, Guangdong Province P.R.China

S9013/S9023-91-A1

Please refer to the real product in case of any change

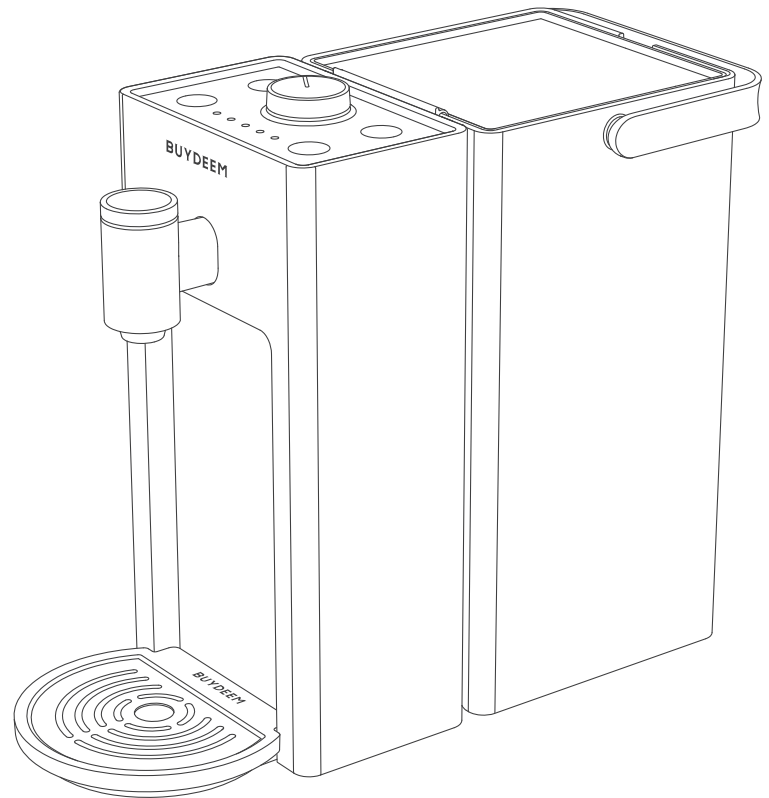

Dear User,

Thank you for purchasing products from BUYDEEM. To ensure that you can fully enjoy BUYDEEM's all-around services, please read this manual and related illustrations carefully and completely before operating this product.

Contents

Notice	02-04
Understanding Product	05-06
Using Product	07-11
Cleaning and Maintenance	12-13
Advanced Functions	14-15
Simple Troubleshooting	16
Warranty	17

IMPORTANT SAFEGUARDS

When using electrical appliances, basic safety precautions should always be followed, including the following:

- Read all instructions.
 - Do not touch hot surfaces. Use handles or knobs.
 - To protect against fire, electric shock and injury to persons do not immerse cord, plugs, or housing body in water or other liquid.
 - Close supervision is necessary when any appliance is used by or near children.
 - Unplug from outlet when not in use and before cleaning. Allow to cool before putting on or taking off parts and before cleaning the appliance.
 - Do not operate any appliance with a damaged cord or plug or after the appliance malfunctions or has been damaged in any manner. Return appliance to the nearest authorized service facility for examination, repair or adjustment.
 - The use of accessory attachments not recommended by the appliance manufacturer may result in fire, electric shock or injury to persons.
 - Do not use outdoors.
 - Do not let cord hang over edge of table or counter or touch hot surfaces.
 - Do not place on or near a hot gas or electric burner, or in a heated oven.
 - To disconnect, turn any control to "off," then remove plug from wall outlet.
 - Do not use appliance for other than intended use.
 - Save these instructions.
- **HOUSEHOLD USE ONLY**
- a) A short power-supply cord (or detachable power-supply cord) is provided to reduce risks resulting from becoming entangled in or tripping over a longer cord.
 - b) Longer detachable power-supply cords or extension cords are available and may be used if care is exercised in their use.
 - c) If a long detachable power-supply cord or extension cord is used:
 - 1) The marked electrical rating of the detachable power-supply cord or extension cord should be at least as great as that of the appliance or tripping over a longer cord.
 - 2) If the appliance is of the grounded type, the extension cord should be a ground-in-type 3-wire cord.
 - 3) The longer cord should be arranged so that it will not drape over the counter top or table top where it can be pulled on by children or tripped over.

SAVE THESE INSTRUCTIONS

DANGER

- To prevent the risks of electric shocks or short circuits, please do not put the water dispenser, power cord, or plug in water or any other liquid.

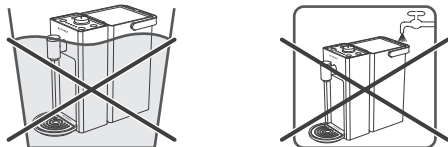

WARNING

- Children, the elderly, people with limited physical or mental abilities, and those without any experience of using similar products should only use this product under supervision and guidance, which ensures their safety. This product is not intended for use by children without supervision and guidance from someone who can take responsibility for their safety.
- This product must be used alone with a grounded outlet with a rated current above 10A and a rated voltage of 120V~ 60Hz. The plug must be fully inserted into the outlet to prevent overheating of the components caused by poor contact, which might lead to the risks of short circuits or fire hazards. Do not use a universal outlet.
- Please keep the water dispenser and power cords away from high temperatures, open flames, damp, smooth surfaces, or sharp edges to prevent component damage, failures, or fires.
- To prevent electric shocks, please do not use the water dispenser with wet hands or bare feet.

CAUTION

- This product is designed for home use only. The manufacturer only provides warranty repair for production defects and faults arising from home use. The manufacturer is not responsible for any consequences or faults caused by any commercial use, unsuitable use, or failure to follow the instructions. Such faults and damage are not covered by the warranty.
- Please check whether the voltage displayed on the product specification label is consistent with the main voltage before using the product.
- If the power cord is damaged, it must be replaced by a professional from the manufacturer, its service department, or a similar department to avoid danger.
- Please always place the water dispenser on a flat, stable, and heat-resistant workbench.
- Please keep this product away from direct sunlight, high-temperature surfaces, or any places close to a heat source. Otherwise, the water dispenser body might fade, and bacteria might grow. Please do not put the water tank in places with direct sunlight or high humidity for a long time. Otherwise, moss might grow.
- Please unplug the power plug immediately if the water dispenser does not work properly.
- If you need to pull out the plug, please hold the plug with your hands and pull it out. Please do not pull or twist the power cord by force. Otherwise, a risk of electric leakage might occur due to damage to the power cord.
- Please do not hang the power cord outside the edge of the table or workbench surface. Otherwise, the water dispenser might fall or cause trip hazards.
- Please do not move the water dispenser when it is working. Otherwise, it might lead to the risk of scalding.

Notice

- It is normal for low ambient temperature and low voltage to cause a relatively reduced hot water flow. When hot water reaches the boiling point, the water output might come along with relatively more vapor. It is normal to see some remaining water drain out after the heating process is completed. It is normal that there is a slight misalignment between the output water temperature and the chosen temperature within a certain range.
- Keep the water dispenser from moisture and freeze.
- Please unplug the water dispenser if you do not use the water dispenser for a long time or clean it with a damp cloth.
- To let the water dispenser work properly, please put the water tank on the dispenser body.
- It is recommended to empty the water tank if the water dispenser is not used for a long time.
- Do not add hot water at a temperature over 50°C to the water tank. Do not let the water tank and its lid come into contact with water at a temperature over 50°C. Otherwise, it might cause deformation or odor.
- Please do not clean the water dispenser with other methods that are not recommended. For recommended methods, please refer to Cleaning and Maintenance in the user's manual.
- It is recommended to add clean drinking water to the water dispenser. Dirt can lead to bacteria growth and odor in the water dispenser.
- If the components of the water dispenser are damaged or cannot work properly, please unplug the power plug immediately. Do not use it or dismantle it by yourself. Please come to a service center authorized by BUYDEEM for replacement or repair.
- Any other use and operations apart from normal cleaning and descaling that are specified in the manual must be conducted by a service center authorized by BUYDEEM.
- Any malfunction or failure to work caused by a lack of cleaning and descaling is not covered by the warranty.
- All products are manufactured following the quality control procedure, including the actual use testing of randomly selected products, which explains any evidence of use on the products.

Technical Specifications

Name	BUYDEEM Water Dispenser		Model	S9013/S9023	
Rated Power	1600W	Rated Voltage	120V~ 60Hz	Maximum Capacity	3.0L
Product Materials	This product is made of food-grade materials, including polypropylene, styrene-acrylonitrile resin, SU304 (06Cr19Ni10) stainless steel, and food-grade silicone.				

Understanding Product

Product Structure

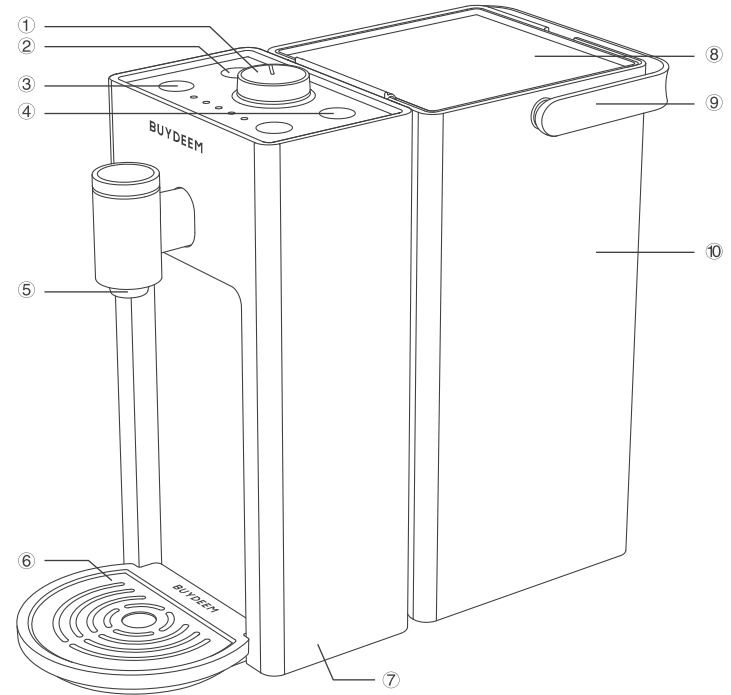

- ① Temperature Regulation Knob/Water Output Button (hereinafter referred to as “Knob”)
- ② Clean Button
- ③ Output Volume Adjustment Button
- ④ Unlock Button
- ⑤ Outlet

- ⑥ Metal Drip Tray
- ⑦ Water Dispenser Body
- ⑧ Water Tank Lid
- ⑨ Water Tank Handle
- ⑩ Water Tank

Understanding Product

Button Function Introduction

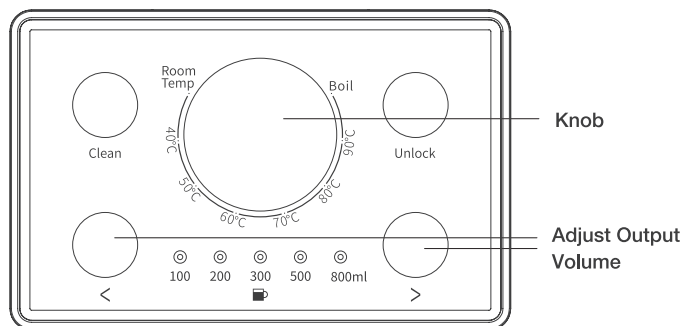

Panel	Function Name	Function Operation Modes
Basic Functions	Lock/Unlock	Due to safety concerns, when the default Auto Lock mode is activated, the water dispenser will be locked automatically if it is idle for one minute after use. The water dispenser can be unlocked or locked manually with this button. Note: When the Auto Lock mode is activated, pressing this button can also stop dispensing water.
	Adjust Output Volume	Available output volume: 100mL/200mL/300mL/500mL/800mL. The two buttons for adjustment are on the left and right sides of the output volume indicator light. Press the left Output Volume Adjustment button, and then the output volume will move to the left for one unit. When the output volume is at the far left, press the left button again, and it will move to the far right. The right button works in the same way.
	Water Temperature Regulation	Available water temperature: Room Temp/40°C/50°C/60°C/70°C/80°C/90°C/Boil. The temperature cannot be changed during the process of dispensing water. Note: In temperature settings (40°C to 90°C) apart from the Boil mode, the water will no longer be heated up after it reaches the target temperature.
	Knob	Press this button to start or stop dispensing water.
	Clean	Clean the water pipes through this function. For specific operation steps, please refer to Cleaning and Maintenance in the user's manual. Before using this function, please carefully read the user's manual and the cleaning tip on the side of the device to prevent accidents.
Advanced Functions	Cancel/Activate Auto Lock	The Auto Lock function can be canceled with this function, keeping the water dispenser in standby mode. (For more details, please refer to Auto Lock in the user's manual.)
	Boiling Point Measurement	The water dispenser can measure the current boiling point and reset the boiling temperature. (For more details, please refer to Boiling Point Measurement in the user's manual.)

Using Product

Initial Use

1. Please remove all the packaging, labels, and accessories inside and outside the water dispenser before using the product for the first time.

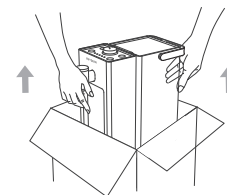

2. It is normal to see some remaining water after pulling out the silicone dust plug at the outlet downward.

Note: For product quality, every device needs to pass the outgoing inspection in terms of the water dispensing function.

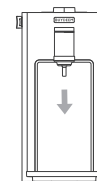

3. It is normal to see some remaining water after tearing off the dustproof sticker from the inlet.

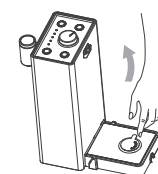

4. Take out the water tank and clean it with water. When cleaning the inside and outside of the water tank, do not let the water tank, the lid, and the handle come into contact with water at a temperature over 50°C. To avoid deformation, please do not steam or boil the water tank.

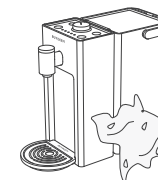

5. Before drinking the water for the first time, please clean the water pipes. For detailed steps of cleaning, please refer to Cleaning and Maintenance - Internal Cleaning in this user's manual. Please do not interrupt the cleaning process in non-emergencies.

Using Product

Daily Use

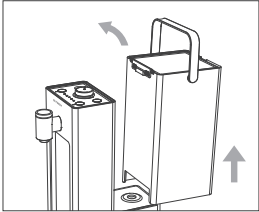

1. Take out the water tank

- Take out the water tank.
- Open the water tank lid.

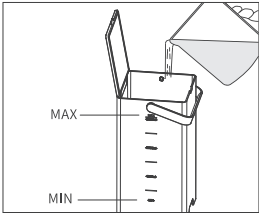

2. Add a right amount of room-temperature purified water

- Add a right amount of drinking water to the water tank.
- Do not fill up the water tank below the "MIN" line or beyond the "MAX" line.
- For health reasons, it is suggested that you use purified water or mineral water.

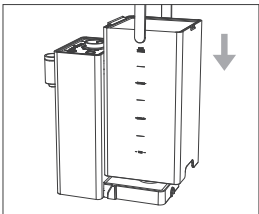

3. Put the water tank back into its base

- Please place the water dispenser on a flat, clean, and heat-resistant surface.
- The water tank shall align the groove in the middle of the water dispenser. Make sure that the hook outside the water tank aligns with the hook on the body of the water dispenser.

Using Product

Daily Use

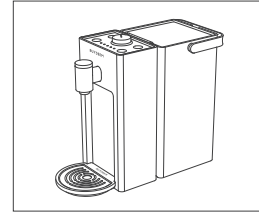

4. Place the drip tray

- Put the drip tray in front of the dispenser body. Adjust the position to make it right under the outlet.

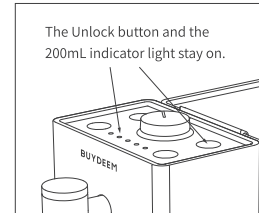

5. Activate the water dispenser

- After plugging in power, all lights on the water dispenser panel will flash with a long "beep" sound generated. The Unlock button and the 200mL indicator light will stay on after the Lock mode is on. All other button lights will turn off. The water dispenser is then activated.

Using Product

Daily Use

1. Unlock

Press the Unlock button for 1 second. The Unlock button light will then turn off (Picture 1).

2. Unlock Notification Sound

If you try to operate the water dispenser when the Lock mode is on, two beeps sound will be generated to remind you that you need to unlock it first.

3. Choose Output Volume

Press either Output Volume Adjustment button to adjust the output volume. The Output Volume indicator light will show the specific output volume. If not adjusted this time, the output volume will follow the last setting. After a chosen output volume of 800mL is dispensed, the water dispenser will automatically restore to the output volume of 200mL (Picture 2).

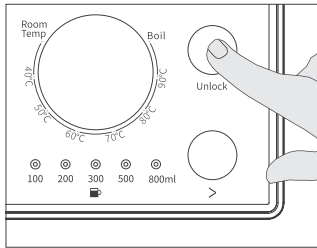

Picture 1

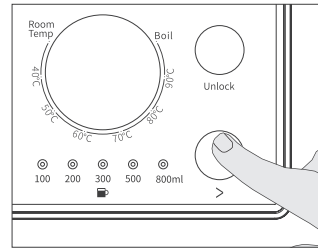

Picture 2

4. Choose Water Temperature

Eight levels of water temperature are available: Room Temp/40°C/50°C/60°C/70°C/80°C/90°C/Boil. Turn the knob to choose a temperature. Please note that the water temperature cannot be adjusted during the process of water dispensing (Picture 3).

5. Dispense Water

Press the knob to start dispensing water (Picture 4).

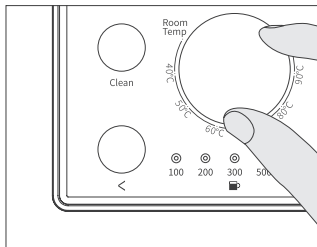

Picture 3

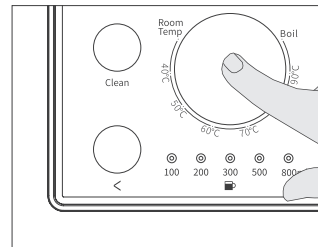

Picture 4

Using Product

Daily Use

6. Stop Dispensing Water

Press the knob to stop dispensing water. (When the Auto Lock mode is activated, a short press on the Unlock button can also stop dispensing water.) (Picture 6)

7. Cancel Auto Lock function

When the Child Lock mode is on, press the Unlock button and the knob at the same time. After three beeps sound, the Unlock button light will turn off. The Auto Lock function is then canceled. The water dispenser will not be locked automatically. You can directly use it without turning off the Child Lock again. (Picture 7)

8. Reactivate Auto Lock function

When the Auto Lock function is inactive, press the Unlock button and the knob at the same time. After you hear three beeps, the Unlock button will light up. The Auto Lock function is then reactivated. The water dispenser will be locked automatically if it is idle for one minute after use. When the Lock mode is on, you need to unlock the water dispenser first for further operation. (Picture 7)

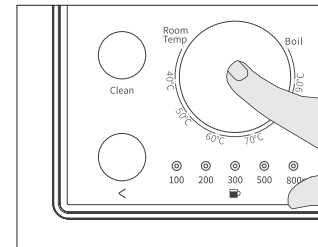

Picture 6

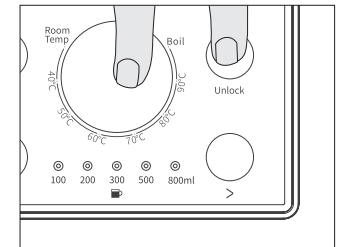

Picture 7

Cleaning and Maintenance

Cleaning and Maintenance

It is normal to smell a slight odor when you unbox the device and use it for the first time. Please leave the device in a ventilated place, and the odor will gradually go away. For water safety, it is suggested that internal cleaning should be conducted when you use the new device for the first time.

1. External Cleaning

- Unplug the power plug.
- Use clean water to clean the water tank and wipe it to dry it. Please do not steam or boil the water tank or use water at a temperature over 50°C.
- Use wrung cloth to wipe and clean the device surface after the water dispenser completely cools off.
- Only the outside of the water tank can be washed with water. Never immerse any part of the water dispenser in water.

2. Internal Cleaning

Note: Do not interrupt the cleaning process after it starts.

- The cleaning process is divided into two rounds. The drainage volume and water temperature are both controlled by the process.
- Add 1000ml of room temperature purified water.
- Prepare a container with a capacity of 3000mL and place it under the outlet. Long press the Clean button to start the cleaning process.
- The water dispenser will drain out all the water in the water tank in the first round of cleaning.
- After the first round of drainage, the Clean button will light up continuously. The knob will flash with a long “beep” sound generated. Please take down the water tank and wash it with clean water at a temperature below 50°C.
- Add 3000mL of room temperature purified water to the cleaned water tank. Press the knob to start the second round of drainage. 2000mL of hot water will drain out in this round. Please be careful and do not get scalded.
- The cleaning is done. You can use the water dispenser as usual.

Cleaning and Maintenance

Tip: After the cleaning process, set the output volume to 800mL and let the water dispenser drain out water at a temperature over 50°C again. This can clean the pipes more thoroughly.

CAUTION:

- If the calcium content of your daily drinking water is higher than 30mg/L, or if floating white particles occur in the water dispenser within 30 days of use, it is suggested that you clean the water dispenser every 10 days.
- If the calcium content of your daily drinking water is lower than 30mg/L, or if floating white particles occur in the water dispenser after 30 days of use, it is suggested that you clean the water dispenser every 30 days.
- If floating white particles occur in the water dispenser when you use it for the first time, it indicates that the water hardness is very high. It is suggested that you change your water supply or use purified water.

Advanced Functions

Boiling Point Measurement

Why do we need a boiling point measurement?

- At high altitudes, the boiling point of water cannot reach 100°C, which makes it difficult for common water dispensers to work normally (the boiling of water takes too long or even fails).
 - BUYDEEM suggested that you should always conduct a boiling point measurement when you use the water dispenser for the first time. When the measurement is done, the chip will record the data of specific boiling points. There is no need to measure it again when you use the water dispenser later.
 - With the boiling point measurement function, the water dispenser can work more accurately (the performance will become better than in the factory setting).
- * If you live in a place at an altitude of over 250 meters, please make sure you conduct a boiling point measurement before you use the water dispenser.

Advanced Functions

Start Boiling Point Measurement

- Prepare a container with a capacity of around 1L and place it under the outlet. To ensure the accuracy of the boiling point measurement, please drain out 500mL of room temperature water before starting the boiling point measurement. After the drainage, long press the left and right Output Volume Adjustment buttons at the same time. After you hear three beeps, the boiling point measurement starts.
- During the measuring process, the left and right Output Volume Adjustment buttons will light on. The breathing light mode of the knob light will be activated. Lights on the Output Volume bar will turn on one by one.
- The water dispenser will drain out water continuously for about 10 to 30 seconds. Please do not interrupt the drainage. Please be careful and do not get scalded.
- When the drainage stops with a long “beep” sound generated, the process is complete.

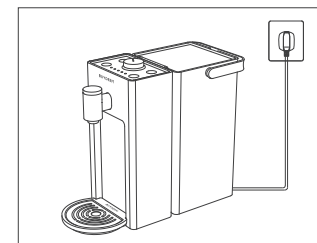
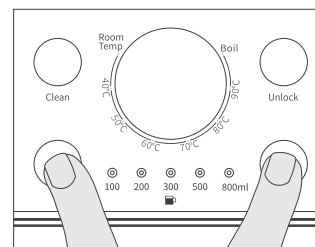

Note:

- Please make sure that the water dispenser can complete an automatic boiling point measurement uninterruptedly so that the detected boiling point can be recorded. If the process is interrupted for any reason, please restart the process.
- The automatic boiling point measurement cannot change the local boiling point. When the target water temperature is set as “Boil”, the water will be dispensed automatically if the water has reached the local boiling point.
- It is normal that any click or boiling sound generates during the process of boiling point measurement.

Simple Troubleshooting

Problem	Possible Causes	Troubleshooting
After powering on, the buttons or knob of the water dispenser do not light up	No power supply	Check if the socket is plugged in
	Product failure	Please contact the service center of purchase channel which authorized by BUYDEEM for replacement or repair
The knob button and the Output Volume Adjustment button flash at the same time with a long “beep” sound generated	The water tank is not properly installed	Please install the product following the manual
	The water level in the water tank is too low	Add enough water to the water tank
	Improper water level	Unplug the power plug and restart the water dispenser
	Product failure	Please contact the service center of purchase channel which authorized by BUYDEEM for replacement or repair
All the lights flash with a long “beep” sound generated	The water temperature in the water tank is over 50°C	Add water at a temperature below 50°C
	Product failure	Please contact the service center of purchase channel which authorized by BUYDEEM for replacement or repair
Odor in water	Product failure	Please refer to Cleaning and Maintenance in the user’s manual and clean the water dispenser. If the odor in the water still exists, please contact the service center of purchase channel which authorized by BUYDEEM for replacement or repair.

Warranty card

BUYDEEM

Dear Customer,

Thank you so much for your purchase! The product comes with a ONE-YEAR warranty.

If you need any warranty support, please have the following information handy when contacting us:

Product Model No.: _____ **Product Name:** _____

Factory Serial No.: _____ **Order Date:** _____

Order ID: _____ **Customer Name:** _____

Customer Phone: _____ **Customer Email:** _____

Please feel free to email us if have any questions or concerns.

More information, visit website: us.buydeem.com

This warranty does not apply:

- If the product has been modified from its original conditions;
- If the product has not been used in accordance with directions and instructions in the user manual;
- To damages or defects caused by accident, abuse, misuse, or improper or inadequate maintenance;
- To damages or defects caused by service or repair of the product performed by an unauthorized service provider or by anyone other than BUYDEEM;
- To damages or defects occurring during commercial use, rental use, or any use for which the product is not intended;
- To damage or defects exceeding the cost of the product.

尊敬的用户：

感谢您购买北鼎产品，为了能让您充分享受北鼎全方位的服务，使用本产品之前请仔细阅读本说明书及相关图解。

目录 Contents

注意事项	02-03
认识产品	04-05
使用产品	06-10
清洁与保养	11
高级功能	12-13
简单故障处理	14
环保清单	15
保修和服务	16-17

⚠ 危险

- 为防止触电或短路等危险，切勿将饮水机、电源线及插头置于水中或其它任何液体中。

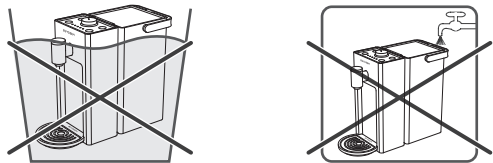

⚠ 警告

- 儿童、老年人、肢体或精神能力受限人士及无使用经验人士应在监督和指导下使用产品，并保证其安全。本产品不打算由儿童使用，除非有可负责其安全的责任人在旁进行监督和指导。
- 本产品必须单独使用额定电流10A以上、额定电源120V~ 60Hz的接地插座，插头需完全插入插座，以防接触不良而导致元件过热烧坏，引发短路或火灾等危险。切勿使用万能插座。
- 请将饮水机和电源线远离高温、明火、潮湿、光滑的台面或锋利的边缘，以防引起器件损坏、故障或火灾。
- 手沾水或赤脚时请勿使用饮水机，以防触电。

⚠ 注意

- 本产品仅设计为家庭使用，厂商仅对生产瑕疵和家用故障进行保修；任何商业用途、不适合用途或未遵照说明操作而造成的后果与故障，厂商均不负任何责任，此等故障损坏均不属于保修范围内。
- 使用前请核对产品规格标贴上显示的电压与主电压是否一致。
- 如果电源软线损坏，为了避免危险，必须由制造商、其维修部或类似部门的专业人员更换。
- 请始终将饮水机放置在平坦、稳固、耐热的工作台上。
- 请勿将本产品放置在阳光直射、高温台面或靠近发热源的地方，否则容易造成机身变色及滋生细菌。请勿将水箱长时间放置在阳光直射或湿度较高的地方，以防青苔滋生。
- 如发现饮水机不能正常工作，请立即拔掉电源插头。
- 如需按下插头，请手握住插头再拔出，请勿强行拉扯或扭曲电源线，以防电源线损坏，产生漏电危险。

- 请不要让电源线悬挂在桌子或工作台面边缘之外，以防饮水机摔落，或引起绊倒。
- 饮水机工作时请不要移动饮水机，谨防烫伤。
- 环境温度及电压较低时，热水流量相对减少，属于正常现象。当热水达到沸点，出水可能伴随较多水蒸气。加热结束后，有少量余水流出属于正常现象。出水温度与选择温度存在一定范围内偏差，属于正常现象。
- 饮水机要防潮、防冻。
- 如果长时间不使用饮水机或用湿布擦拭饮水机时请将插头拔除。
- 请将水箱放置在机身上，饮水机才能正常使用。
- 长时间不使用饮水机，建议将水箱内的水清空。
- 水箱、水箱盖不可加放或接触热水(50°C以上)，以防变形或产生异味。
- 请不要用非推荐的方法清洁饮水机，推荐方法详见说明书-清洁与保养。
- 推荐放入干净的可直接饮用水，以免不干净的物质在水机内部滋生细菌及异味。
- 如发现饮水机部件损坏或不能正常工作时，请立即拔掉电源插头，切勿继续使用，也勿自行拆除，请前往北鼎授权的服务中心进行更换或维修。
- 除了按照说明书进行清洁和除垢，其它任何非正常使用操作必须由北鼎授权的服务中心进行。
- 由于未对饮水机进行清洁和除垢造成其不能正常使用或完全不能使用的情况，不属于保修范围。
- 所有产品均严格按照质量控制程序，其中包括对随机抽检产品的实际使用测试，所以其将对产品的任何使用痕迹作出解释。

技术规格

产品名称	北鼎桌面即热饮水机		产品型号	S9013/S9023	
额定功率	1600W	最大容量	3.0L	额定电源	120V~ 60Hz
产品材质	本产品采用食品接触用材质：聚丙烯PP塑料、丙烯腈-苯乙烯共聚物AS塑胶、SUS304(06Cr19Ni10)不锈钢、食品接触用硅胶				

产品结构图

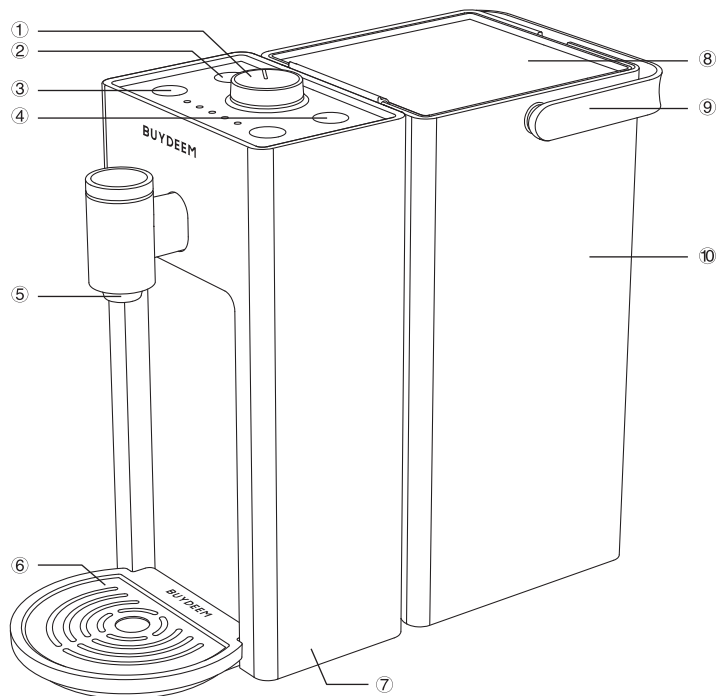

- | | |
|------------------------|---------|
| ① 温度调节旋钮/出水按键 (此后简称旋钮) | ⑥ 金属沥水盘 |
| ② 清洁键 | ⑦ 水机机身 |
| ③ 出水量调节键 | ⑧ 水箱盖 |
| ④ 童锁触摸键 (此后简称“解锁键”) | ⑨ 水箱提手 |
| ⑤ 水机出水口 | ⑩ 水箱 |

按键与功能介绍

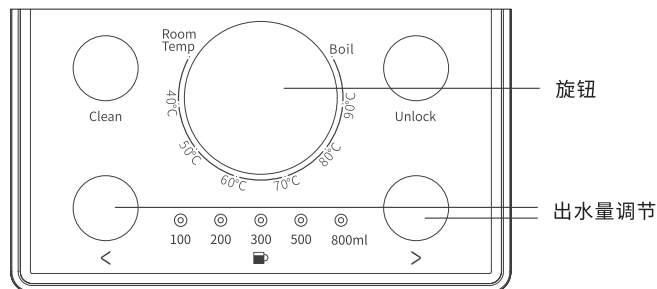

面板	功能名称	功能运作方式
基础功能	锁定/解锁	出于安全保护的目的,在默认自动锁定开启的状态下,饮水机在每次使用完毕后,闲置1分钟会自动进入锁定状态。通过此按键,可手动解锁或锁定饮水机。注:在自动锁定生效的状态下,如在出水过程中需要中止出水,也通过此按键停止出水。
	出水量调节	可选择出水量:100mL/200mL/300mL/500mL/800mL 按键分左、右两个,分别位于出水量指示灯的左右两侧。单击左出水量调节键,则出水量档位往左一格,当出水量档位已处于最左档位时,往左则跳转至最右档位。右键同理。
	水温调节	可选择水温:常温/40°C/50°C/60°C/70°C/80°C/90°C/沸腾。出水途中改变水温,机器将不作响应。注:除沸腾外,40°C-90°C温度段只将水温加热到指定温度。
	旋钮	单击此按键,可启动或停止出水。
高级功能	清洁	通过此功能,可进行水路清洁。具体操作请参照说明书-清洁与保养。使用该功能前请认真阅读说明书及机箱侧边的清洁指示贴纸,以免发生意外。
	取消/开启自动锁定	通过此功能,可关闭自动锁定功能,使饮水机一直处于待机的状态。(详情请参照说明书自动锁定功能。)
	沸点检测	通过此功能,饮水机可根据所在地的沸点,重新设定沸腾温度。(详情请参照说明书沸点检测功能。)

初次使用

1. 在初次使用产品之前, 请去除饮水机内外其余包装, 标签及附件。

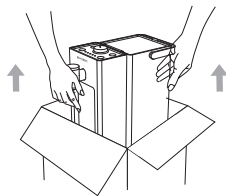

2. 向下拔出出水口处的硅胶防尘塞, 如有少量余水为正常现象。

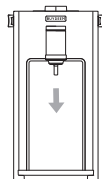

注: 为确保产品品质, 每台机器在出厂前都会通过制水检测产品是否合格。

3. 揭下进水口的防尘贴纸, 如有少量余水为正常现象。

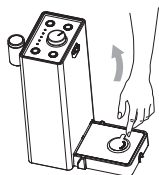

4. 将水箱拆下后用水清洗, 用清水清洗水箱内外壁, 注意水箱、水箱盖以及水箱把手不可接触50°C以上的水, 严禁蒸煮水箱, 以防变形。

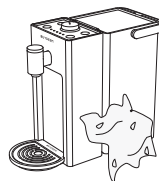

5. 初次饮用前, 请先进行水路清洁, 具体清洁方式请参照本说明书-清洁与保养-内部清洁。清洁过程中若非特殊情况, 切勿打断清洁。

日常使用

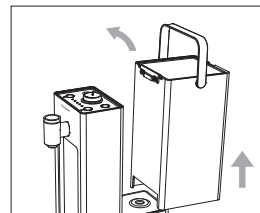

1. 取出水箱

- 将水箱取出。
- 打开水箱盖。

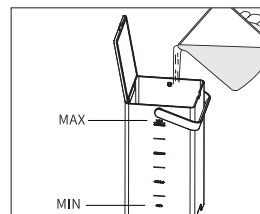

2. 加入适量的常温纯净水

- 往水箱加入适量的饮用水。
- 水箱内水量勿低于“MIN”或高于“MAX”。
- 为了您的健康, 建议使用纯净水或矿泉水。
- 请勿使用自来水。

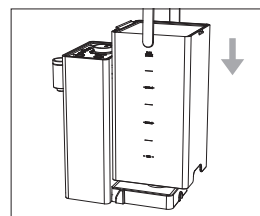

3. 将水箱放回水箱底座

- 水机务必放置在平坦、干净的耐热台面。
- 水箱对准水机中间的凹槽, 确保水箱外壁的卡扣与水机机身的卡扣正确对接。

日常使用

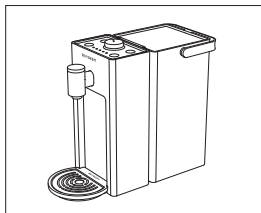

4. 放置沥水盘

- 将滴水盘放置到到机身前，调整位置对准出水口下方。

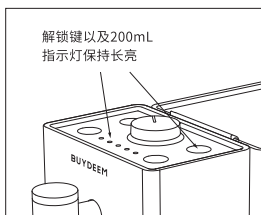

5. 启动饮水机

- 插上电源后，水机面板所有灯短暂亮起，并听到“滴”声长响，之后解锁键以及200mL指示灯保持长亮，进入锁定状态，其余按键灯灭，表示开启。

日常使用

1. 童锁解除 轻触解锁键1秒解除童锁，解除后解锁键灯灭。
2. 解锁提醒 在饮水机锁定状态下，若未解锁进行操作，饮水机将发出“滴滴”两声提醒解锁。
3. 出水量选择 轻触任意一个出水量调节键，调节出水量。具体出水量将由出水量指示灯显示。若本次不进行出水量调节，则保持前一次的出水量选择。当选择的出水量为800mL时，出水结束后将自动跳转至200mL出水量。



图1



图3

4. 水温选择 水机设有常温/40°C/50°C/60°C/70°C/80°C/90°C/沸腾共八档水温可选。旋转旋钮选定温度。请注意，出水过程中无法调节水温。

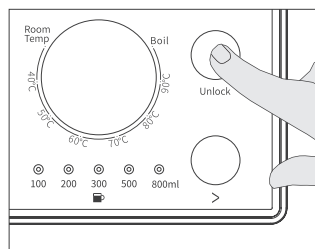
5. 出水 按下旋钮，启动出水。

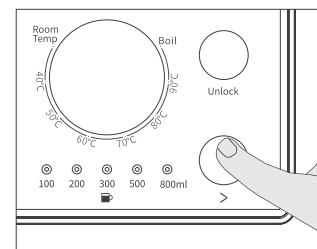

图4



图5

日常使用

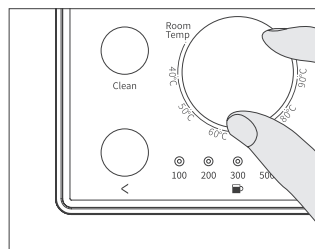
6. **中断出水** 按下旋钮,可中断出水。(在自动锁定启动的状态下,短触解锁键也可中断出水。)

7. **取消自动锁定功能** 在童锁开启的状态下,同时按下解锁键和旋钮,此时会出现“滴滴滴”三声提示音,解锁键灯灭。此时,自动锁定功能被取消,水机将不会自动进入锁定状态,使用前无需再解除童锁。

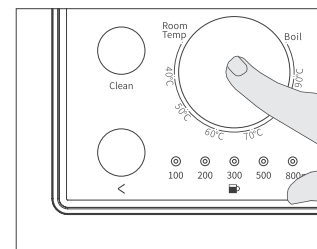
8. **恢复自动锁定功能** 在自动锁定功能已取消的状态下,同时按下解锁键和旋钮,此时会出现“滴滴滴”三声提示音,解锁键亮起。此时,自动锁定功能被恢复,饮水机在每次使用完毕后,闲置1分钟会自动进入锁定状态。锁定状态下的所有操作需要先解锁后进行。



图6



图7

清洁与保养

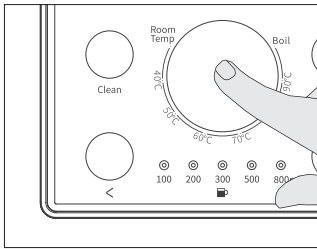
机器初次开箱使用会有轻微异味,属新机正常现象,请将机器放置于通风环境下,气味会逐渐消散,为确保用水卫生,新机首次使用时建议进行内部清洁。

1. 外部清洁

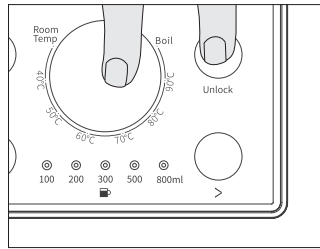
- 拔下电源插头。
- 水箱清水清洗,并擦干。注意请勿使用50°C以上的水,严禁蒸煮水箱。
- 待饮水机完全冷却后用拧干的抹布对机器表面擦拭清洁。
- 饮水机除水箱外机身,应避免用水直接冲洗,任何时候不得浸入水中。

2. 内部清洁

注意:请不要在启动清洁程序后中断清洁。

- 清洁程序分为两轮,出水量及水温均由程序控制;
- 在水箱中加入1000ml的常温纯净水;
- 准备一个3000mL的容器放置于出水口下方,长按清洁键进入清洁程序;
- 第一轮清洁,饮水机会将水箱内所有水排出;
- 第一轮出水结束后,清洁键转为长亮,旋钮闪烁并伴随“滴”的一声长响,此时,请取下水箱并用50°C以下的清水彻底冲洗,确保水箱中无清洁片溶液残留;
- 往清洁后的水箱加入3000mL的常温纯净水,按下旋钮,启动第二轮出水,本轮将出2000mL的热水,谨防烫伤;
- 清洁完成,可正常使用水机。

建议:在清洁功能结束后,选择50°C以上的水,并将出水量档位调节至800mL,再次出水,可以更彻底的对管道进行清洁。

注意:

- 如果您日常饮用水钙含量高于30mg/L,或者饮水机在使用30天以内出现白色漂浮物,建议每10天清洗一次;
- 如果您的日常饮用水钙含量低于30mg/L,或者饮水机使用时间超过30天时出现白色漂浮物,建议每30天清洗一次;
- 若首次使用饮水机就出现白色漂浮物,表示水质硬度等级较高,建议更换水源或使用纯净水。

沸点检测

为什么要做沸点检测？

- 由于在非零海拔地区，水在沸腾时无法达到100°C，这将导致普通饮水机无法正常工作（烧制过慢甚至无法正常烧开）。
- 北鼎建议您在第一次使用时，均进行一次沸点检测操作。检测完成后，芯片将记录精确沸点数据，再次使用无需重复检测。
- 经过沸点检测后，饮水机能更精准地工作（性能比出厂设置时更佳）。

*若您处于海拔高于250m的地区，请必须进行沸点检测操作后再使用。

启动沸点检测

- 放置1L左右的容器于出水口下方，为保证沸点检测精准度，在启动沸点检测前请先进行500mL的常温出水。完成出水后，同时长按住出水量左+出水量右，听到“滴滴滴”3声提示音后饮水机进入沸点检测；
- 检测过程中，左右两个出水量调节键亮起，旋钮键灯呈现呼吸灯状态，出水量档位灯逐个亮起；
- 饮水机持续出水约10-30秒。请勿中断出水，谨防烫伤；
- 出水停止并伴有“滴”声长响，表示过程结束。

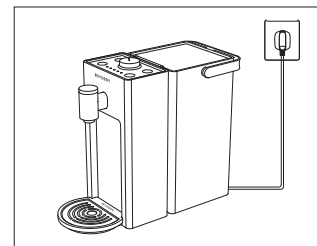
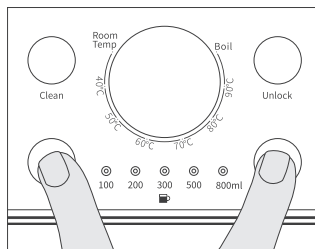

提示：

- 请确保饮水机在不间断的情况下完成一次自动检测沸点程序，检测到的沸点才能被记忆。如遇任何因素被迫中断程序，请重新执行该程序。
- 自动沸点检测不能改变当地沸点。当设定水温度为“沸腾”时，水温烧至当地沸点，则自动出水。
- 沸点检测过程中，如反复出现“咯哒”声、沸腾声均属正常现象。

简单故障处理

故障现象	原因分析	故障排除
饮水机通电后， 按键或旋钮不亮	未接通电源	检查插座是否已插好
	饮水机故障	联络北鼎客户服务中心
旋钮键及出水量 调节键同时闪烁 并出现“滴”声 长响	水箱未安装妥当	按说明书指引正确安装
	水箱水位过低	水箱加入足够水量
	水位不良	拔掉电源，重启饮水机
	饮水机故障	联络北鼎客户服务中心
全部灯圈闪烁并 出现“滴”声长响	水箱内水温高于50°C	装入低于50°C的水
	饮水机故障	联络北鼎客户服务中心
水有异味	未使用过的新饮水机	请参考说明书-清洁与保养，对水机进行清洁。若仍然存在异味，请联络北鼎客户服务中心

保修和服务说明

如果产品有明细损坏，请您参看保修条件填好资料，将产品退回北鼎授权的售后服务中心修理，产品型号及序列号可见于产品底部。

- 保修仅限生产缺陷及参照说明书正确使用造成的损坏。
- 如果电源线损坏，为避免危险，必须由生产商、售后服务中心的专业人员进行维修或更换。

以下情况恕不免费维修

- 无三包凭证及有效发票
- 未按说明书的要求操作引发的故障

A. 消费者使用、保管、维护不当造成的损坏。

B. 非本公司指定维修部自行装拆修理而造成的损坏。

C. 因不可抗力造成的损坏。

为了客户的利益，北鼎保留对产品特性及组件做出修改的权利，以确保产品的正常使用。

如果需要更多的服务和信息，或有任何疑问，请访问北鼎网站：us.buydeem.com，或与当地经销商联系。



保修卡

- 1.根据“新三包”规定整机保修期为一年(自开具发票之日起)。
- 2.发票和保修证书一同作为保修凭证,发票一经涂改,保修即失效。
- 3.因使用不当或其他非产品本身质量问题造成的损坏,将收取零件成本及人工费。

顾客姓名 _____ 联系电话 _____ 邮 箱 _____

地 址 _____

产品型号 _____ 购买日期 _____ 经销商 _____

机身号码 _____

日期	原因	维修员