

BUYDEEM

K2693

多功能电水壶（养生壶）

使用说明书

Health-care Beverage Maker
Instruction Manual

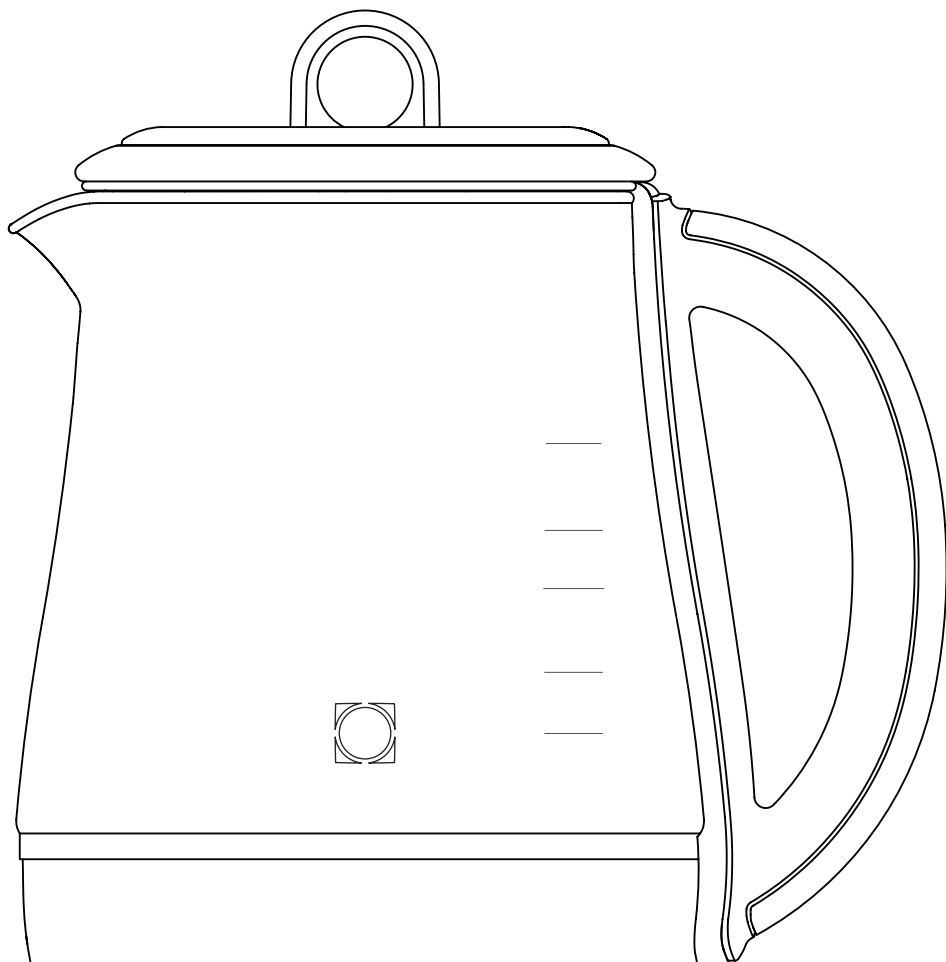

Thank you for purchasing Buydeem product. In order to enjoy the full support from Buydeem, please read this manual and the relevant illustrations carefully before using.

Contents

Notice	30
Technical specification	31
Knowledge of product	32~40
Product structure drawing	32
Function introduction	33
Component introduction	36

Usage of product	41~45
Initial use	41
Quick installation	41
Usage guidelines	42
Special function	46~48
Cleaning and maintenance	49
Handling of simple malfunctions	50
List of Environmental Protection	51
Warranty and service	52
Warranty card	53

Notice

IMPORTANT SAFEGUARDS

When using electrical appliances, basic safety precautions should always be followed, including the following:

- Read all Instructions.
- Do not touch hot surfaces. Use handles or knobs.
- To protect against fire, electric shock and injury to persons do not immerse cord, plugs, or Base and Body in water or other liquid.
- Close supervision is necessary when any appliance is used by or near children.
- Unplug from outlet when not in use and before cleaning. Allow to cool before putting on or taking off parts, and before cleaning the appliance.
- Do not operate any appliance with a damaged cord or plug or after the appliance malfunctions, or has been damaged in any manner. Return appliance to the nearest authorized service facility for examination, repair or adjustment.
- The use of accessory attachments not recommended by the appliance manufacturer may result in fire, electric shock or injury to persons.
- Do not use outdoors .
- Do not let cord hang over edge of table or counter, or touch hot surfaces.
- Do not place on or near a hot gas or electric burner, or in a heated oven.
- Always attach plug to appliance first, then plug cord into the wall outlet. To disconnect, turn any control to "off," then remove plug from wall outlet.
- Do not use appliance for other than intended use.
- Scalding may occur if the lid is removed during the brewing cycles.

SAVE THESE INSTRUCTION

When using electrical appliances, basic safety precautions should always be followed, including the following:

- A short power-supply cord (or detachable power-supply cord) is provided to reduce risks resulting from becoming entangled in or tripping over a longer cord.
- Longer detachable power-supply cords or extension cords are available and may be used if care is exercised in their use.
- If a long detachable power-supply cord or extension cord is used:
 - 1.The marked electrical rating of the detachable power-supply cord or extension cord should be at least as great as the electrical rating of the appliance;
 - 2.If the appliance is of the grounded type, the extension cord should be a grounding-type 3-wire cord;
 - 3.The longer cord should be arranged so that it will not drape over the counter top or table top where it can be pulled on by children or tripped over.

Dangerous

- Do not use this product without supervision, otherwise there may be fire and other hazards caused.
- In order to prevent electric shock or short circuit, do not put the product, base, power cord and plug in water or any other liquid.

Warning

- This product must use the earthing socket with rated current of more than 10A and rated voltage of 120V~60Hz separately. The plug shall be fully inserted into the socket to avoid the risk of overheating and burning of the component due to poor contact, which may lead to dangers like short circuit or fire, etc.
- Do not use all-purpose socket.
- Keep the beverage maker and power cord away from high temperature, open flame, damp, smooth surface or sharp edges to prevent device damage, malfunction or fire.
- Prohibit the use when hands with water or bare feet.

Notice

Notice

- This product is only designed for home use. The manufacturer only guarantees the production defects and household failures, not be liable for any consequences or failures arising from any commercial use, inappropriateness, or failure to comply with the instructions and such malfunction and damage are not covered by the warranty.
- Please check whether the voltage indicated in the product specifications label is the same as the main voltage before used.
- This product must be used with its matched base. Please do not use any other base.
- Please keep the health kettle on a flat, stable and heat resistant worktable.
- Before using the product, please make sure that the upper cover is properly covered to prevent burns.
- Do not put the sealed container in the kettle to heat, otherwise there may be risk of explosion.
- Do not operate beverage maker beyond the maximum water level or below the minimum water level; if the water or food in the health kettle is too full, boiling water may splash out. If the water or food in the health kettle is too little, it may cause dry burning and paste bottom.
- The product should be moisture-proof and frost-proof. Do not put it in the refrigerator.
- To prevent electrical shock or fire, make sure the power supply is disconnected under the following circumstances: When the beverage maker is empty, not be used, be cleaned or moved, or when the components are damaged and breaks down.
- It is recommended to drain the water from the kettle if not use for a long time.
- If you need to pull the plug, please hold the plug and pull it out by hand. Do not force or twist the power cord, to prevent the power cord damage, and eliminate the electrical leakage.
- Please don't hang the power cord outside the desk or the edge of the work table to prevent the water dispenser from falling or a trip.
- Please don't use non recommended methods for descaling. Recommended methods please refer to P23.
- Please unplug the power plug immediately if your components of product has been damaged or can't be used properly, do not disassemble and go to the authorized service center of Buydeem for replacement or maintenance.
- In addition to cleaning and descaling in accordance with the instructions, any other abnormal operation shall be performed by the authorized service centre of Buydeem.
- Theun-normal use or complete out of use due to non-descaling is beyond guarantee range.
- It will explain any traces of the product use because all products are strictly in accordance with the quality control procedures, including the actual use testing of the products inspected randomly.

Technical specifications

Product name: Health-care Beverage Maker Product model: K2693 Rated power: 1000 W Rated voltage: 120V ~ 60Hz Maximum capacity: 1.5 L

German Schott glass SUS304 (06Cr19Ni10) and SUS316L (022Cr17Ni12Mo2) stainless steel, Polypropylene PP plastic, silicone for food contact is adopted.

Understanding Product

Product structure drawing

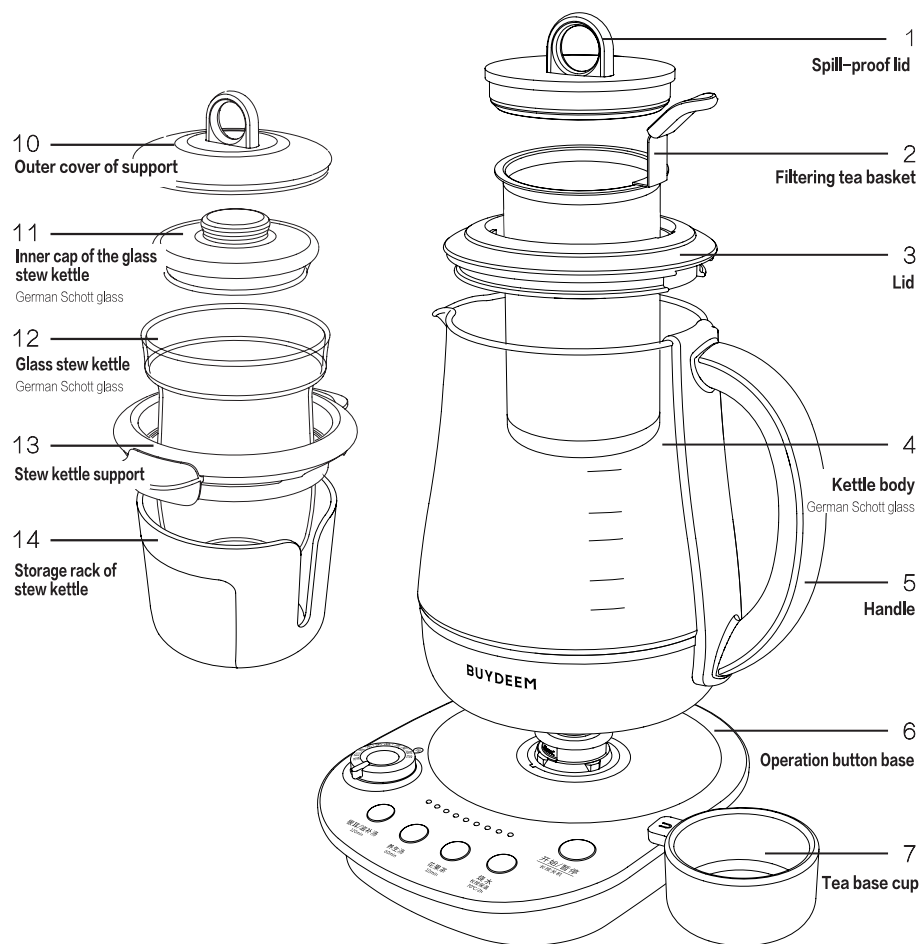

Understanding Product

Function introduction

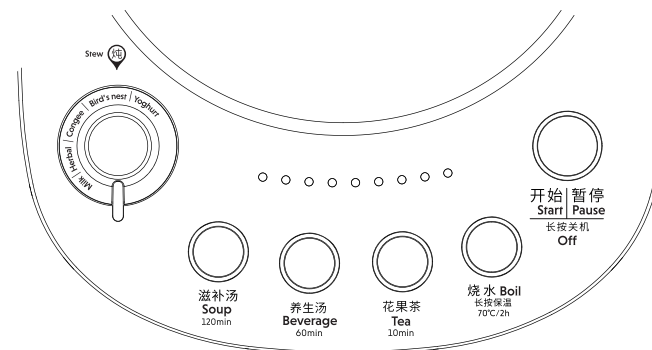

Type of function	Function	Ingredients for cooking	Work mode
Basic functions	Start / Pause	/	Start/Pause after press the key. Long press 2s to stop.
	Boil	/	Quickly boil the water until it boils, and stop working. Do not use this function button to heat the soup/liquid except water, otherwise overflow may occur.
	Manual heat preservation	/	Maintain the water temperature at 70° C, 2 hours. In the state of heat preservation, the lamp ring is a breathing lamp. When the temperature is higher than 70° C, the product will preserve heat after water temperature dropped to 70° C.
Cooking function button	Tea (10 min)	Flower tea, fruit tea, Chinese fermented tea, etc.	Work 10 mins under Flower and Fruit Tea mode after water is boiled. Auto heat preservation for 2h under 70° C after program end.
	Beverage (60 min)	Bean, red dates, Lotus seed, etc.	Work 60 min under Nutritious Soup mode after water is boiled. Auto heat preservation for 2h under 70° C after program end.
	Soup (120 min)	Tremella, Chinese honeylocust fruit grain, barley, etc.	Work 120 min under Tremella/Nutritious Soup mode after water is boiled. Auto heat preservation for 2h under 70° C after program end.

Understanding Product

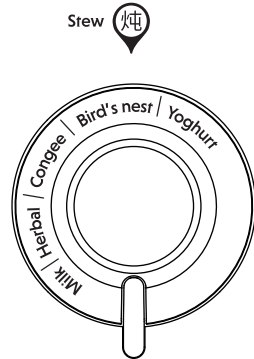

Type of function	Function	Ingredients for cooking	Work mode
Stew function button	Milk (60°C / 10 min)	Warm milk	Heat water in kettle to 60° C, and preserve heat for 10 min in Milk Heating mode
	Herbal (120 min)	Stewing cordyceps flowers, fish maw, bone soup, etc.	Work 120 min under Herbal mode after water is boiled. Auto heat preservation for 2h under 70°C after program end.
	Congee (60 min)	Stewing grain congee, vegetable congee, etc.	Work 60 min under Congee mode after water is boiled. Auto heat preservation for 2h under 70°C after program end.
	Bird's nest (30 min)	Stewing bird' s nest etc.	Work 30 min under Bird' s Nest mode after water is boiled. No auto heat preservation.
	Yoghourt (40°C / 8H)	Make yogurt	After heating the water to 40C° , it will preserve heat for 8 hours in yogurt mode. If the water temperature in the health kettle is too high, when choosing the function of "yogurt", the product will produce five short bursts and stop working automatically.

Understanding Product

LED progress bar

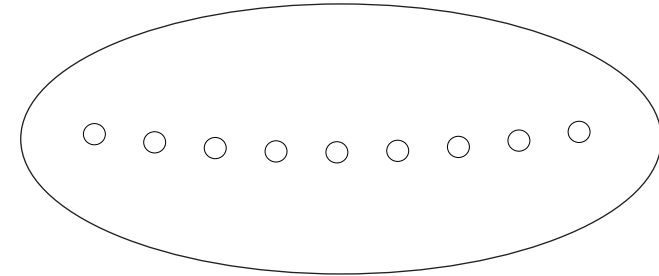

- When the kettle starts cooking procedure, the LED progress bar will gradually turn on the light from left to right along with the completion of cooking function. Users may judge the cooking progress by the light display status.

Type of function	The operation mode of the LED bar
Boiling	The LED bar represents the completion of the kettle temperature.
Heat preservation	When product is in heat preservation state, the light goes out.
Other cooking function	The LED bar represents the progress of temperature and cooking time. When the first light is on, it means that the liquid in the kettle is in the boiling state, and the remaining 8 lights represent the progress of time.

Understanding Product

Parts design

Spill-proof lid design

- The unique design by placing two nested "spill-proof lids" is used based on the daily use habit of users.
- When product works normally, users can unscrew the spill-proof lid at any time to observe the state of food cooking, so as to choose to carry out various operations such as adding materials or seasoning.
- If excessive foam occurs during cooking, it is recommended to open the spill-proof lid, which can effectively prevent spillage.

1. Assembly of the spill-proof lid

- Hold the handle against the lid and turn clockwise to tighten it.

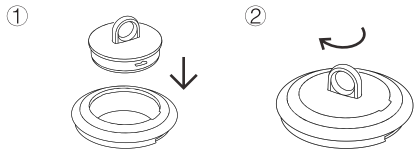

2. Disassembly of the spill-proof lid

- Hold the handle against the lid and turn counterclockwise to unscrew it.

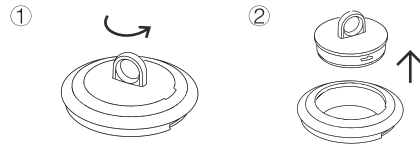

Design of the filtering tea basket

- To make it easy for users to filter non-edible ingredients/tea leaves, the product is added with the unique design of the handle tea basket.
- During the cooking process, users can put non-edible ingredients into tea basket; If worry about the strong taste, open the lid of the tea basket during cooking and remove the tea basket.

1. Installation of the filtering tea basket:

- Grab the handle of tea basket and put it into the hollow part of kettle cover;
- Clockwise to tighten the tea basket cover, and it had tightened when heard a slight sound of "tick".
- Put the whole cover into the kettle and install it on the spout, aim the filter at the spout and gently press to close the lid.

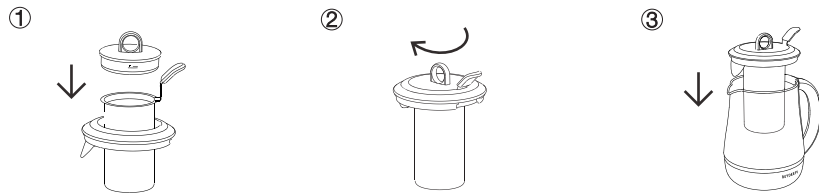

Understanding Product

2. Disassembly of the filtering tea basket:

- Unscrew the lid of tea basket anticlockwise;
- Grab tea basket handle and bring it up.

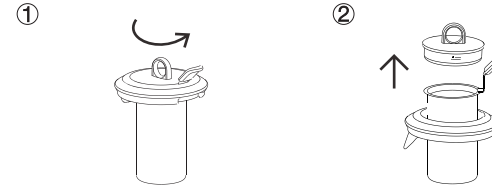

Tea base cup design

- In order to facilitate user to place and store tea basket, the product is added with unique design of tea base cup.
- The tea base cup is with patent magnet structure, and can 180° attach to the base to prevent lost.
- When tea basket is removed from product, it can be placed in tea base cup to prevent the table getting wet from the dripping tea basket.

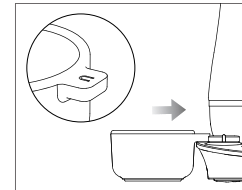

Understanding Product

Stew pot design

- In addition, a unique design of scaffolding stew pot is added to the product to meet the more comprehensive daily usage requirements of users.
- Users can stew food separately with water and directly observe the cooking state because of the material of glass.

Note:

- Please do not pour water when using the holder to avoid the scald caused by the fall of stew pot and holder.
- Do not directly heat the glass stew pot with open flame.
- Do not put the glass stewed pot in oven or microwave oven to heat.
- The effective maximum capacity of the stew pot is 500 ml (about 70% of the height of the stew kettle), and please do not exceed the maximum capacity when using, so as to avoid scalding caused by spillage of ingredients during use.

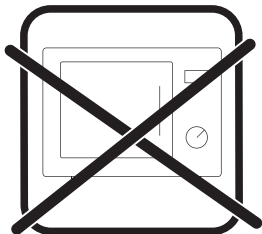

Understanding Product

1. Installation of the glass stew pot:

- Place ingredients in the stew pot and cover with glass inner lid;
- Place the stew pot into the bracket.
- Lift the bracket together with stew pot;

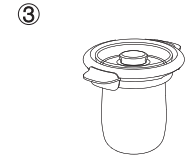
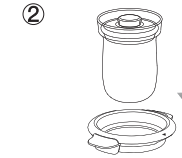
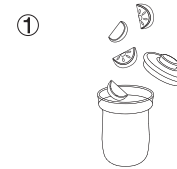

- Install the stew pot on spout. When the bracket triangle marks align the spout and handle, the installation is completed.
- Cover the outer lid of the stew pot bracket, and the installation is completed.

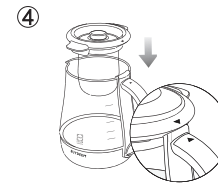

2. Disassembly of the glass stew pot :

- Lift the holder and bring it out with the stew pot;
- Lay down the bracket gently;
- Take the outer lid off the holder;

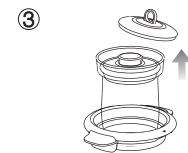

- Remove the stew pot.
- Take the inner cap of the glass stew pot off, and serve immediately.

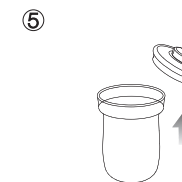
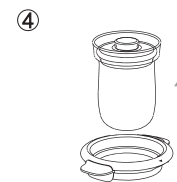

Understanding Product

Storage design of stew pot

- For the convenience of storage and drying stew pot for users, the product is added with unique design of the storage rack of stew pot.
- After using the stew pot, the user can place it in the storage rack to dry; After drying, the stew pot can be placed in the storage rack for storage.

1. Drying of the stew pot:

- After washing stew pot, put the glass lid into the storage rack first;

①



- Place the glass stew pot upside down;

②

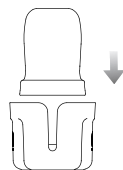

- Place the stew pot bracket and outer lid of the stew kettle bracket successively;

③

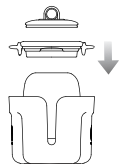

- Place the stew pot and its bracket as shown in the picture until dry.

④



2. Storage of stew pot:

- Place the stew pot into the bracket;

①

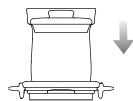

- Lift the bracket together with the stew pot into the storage rack, and then put in the outer lid of the bracket.

②

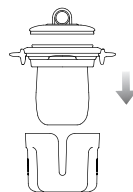

Using Product

I. Initial use

1. Remove all the packaging, labels and accessories inside and outside of product.
It is recommend for you to do a boiling point test (see P20) before initial use of the product.

2. Boiled water for the first 2 to 3 times should be drained for cleaning, and then wipe the external parts with a wet cloth. (Please notice that the electronic connector on bottom of the product and the base can't touch water).

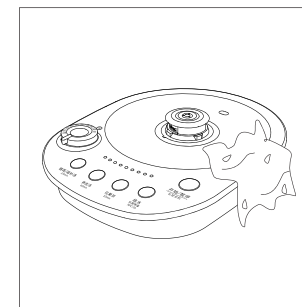
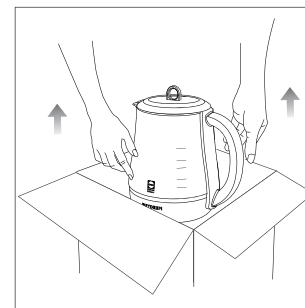

2. Quick installation

1. Adjust the length of power cord through the winding device of the base.

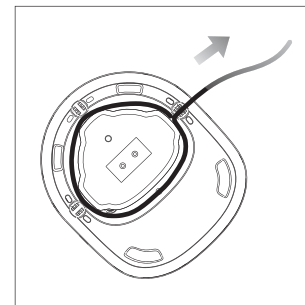

2. Put the product on the bottom



Using Product

III. Usage guidelines

Cooking

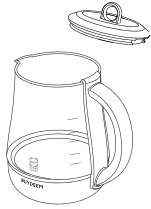

1. Open the lid

- Grasp the spill-proof lid handle and pull it up to open the cover.



2. Add proper amount of pure water

- Don't add water when the product is on the base.



3. Add the foods

- Never add water and foods over the maximum or below the minimum water level.
- It may splash water if overfilling when boiling.
- Please note that it is recommended to add water to 1000ml for tremella, fuciformis, astragalus, dark tea and other easily foaming foods, and open the spill-proof lid when cooking.



4. Close the lid

- Place the lid on the kettle body as shown. Press lightly to close the lid and gently lift it with your hands. If it doesn't lift, it means the lid is tight.
- If the lid assembly is not in place, it will fall easily when pouring water.
- Please note that when close the lid, make sure the spout filter is aligned with the spout, otherwise the lid is not tight.

Using Product



5. Put the kettle on the base

- Please dry the water at the bottom of the kettle and on the base.
- The base must be placed on a flat, clean, heat-resistant table.
- Exclusive base must be used with the body of beverage maker.
- Do not use if no water in the kettle.



6. Plug in the power

- When the product is energized, the buzzer makes a noise, the button light flashes and turns off later, indicating that the device is in standby mode, and the function can be started.

Stew



1. Put food into the grass stew pot

- Put food into stewing pot and add some water. Make an installation as shown on page 13.



2. Add some fresh water to the kettle

- Add water into the kettle to 1000ml (the water level before putting in the kettle).
- Do not add water when the kettle is on the base.

Using Product

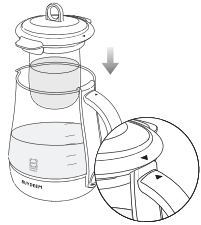

3. Installation of kettle lid

- Lift the holder together with the stew pot and install it to the kettle.
- Pay attention! Please make sure the triangle mark on the holder aligns the one on the handle of kettle body, otherwise, it is not installed properly.



4. Put the kettle on the base

- Please dry the water at the bottom of the kettle and on the base.
- The base must be placed on a flat, clean, heat-resistant table.
- Exclusive base must be used with the body of the health kettle.
- Do not use if no water in the kettle.

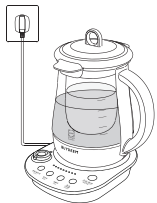

5. Plug in the power

- When the product is energized, the buzzer makes a noise, the button light flashes and turns off later, indicating that the device is in standby mode, and the function can be started.

Using Product

Guidelines for functional mode

Guidelines for use of boiling function(Soup, Beverage, Tea, Boil).

Step 1: Select any button in the left figure, such as boil water.

Step 2: Press the "start/pause" button to start the corresponding function mode.

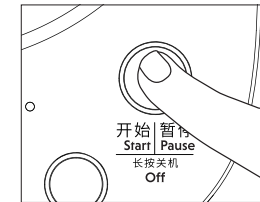
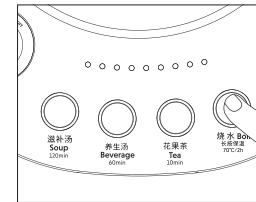

Guidelines for manual heat preservation

Step 1: Long press the "boil water/long press the heat preservation" button for 2 seconds until the lamp ring displays the breathing light.

Step 2: Press the "start/pause" button to start the heat preservation mode.

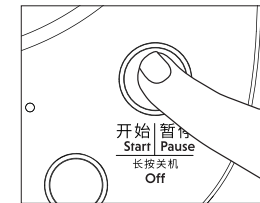
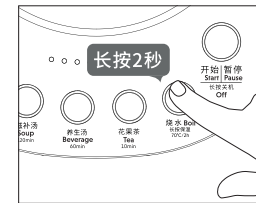

Guidelines for the use of stewing function (yogurt, bird's nest, congee, herbal and warm milk)

Step 1: Rotate the knob in the left figure to make the selection function align with the "" sign.

Step 2: Press the "start/pause" button to start the corresponding stewing function mode.

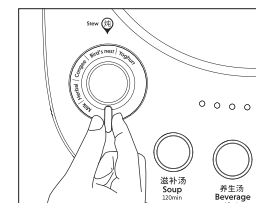

Features

Memory program for boiling point test

- It cannot reach 100 °C when water boiling in the nonzero elevation area, which will cause the failure to work properly (break off too slow or even unable to trip normally) for the ordinary beverage kettle.
 - Buydeem recommend to carry out a boiling point testing for the initial use. Upon completion of the test, the chip will record accurate boiling point data and no need for a repeated testing when reuse.
 - After the boiling point testing, the product can work more accurately (better performance than the factory setting).
- * If you are in a city above 250m, the boiling point test must be performed before use.

Start the boiling point testing

1. Add water to 1200ml, it will affect the test result if there is not enough water or too much.



2. Put on the base without electricity firstly.



Features

3. Press on the buttons of "boil" and "tea", plug in the power supply at the same time. You can release the button after a short whistle.

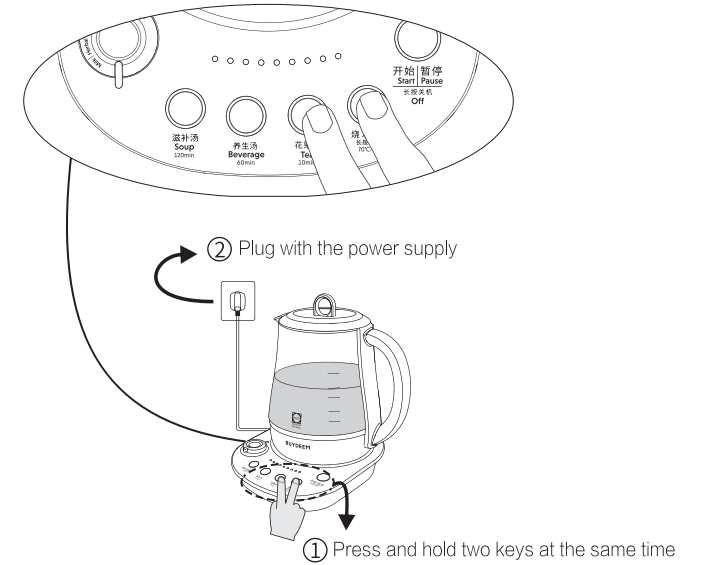

4. The light ring of "start/pause" button blinks at this point, and all button indicators blink in turns after pressed the "start/pause" button. The machine enters the working state to test the boiling point.

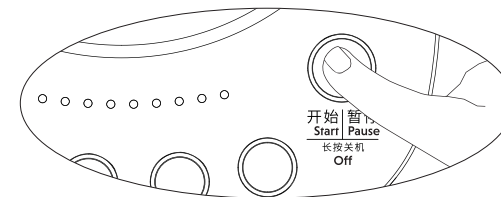

Features

Pause of memory function by lifting kettle

It can be suspended when working in accordance with the procedures for the product by lifting kettle or pressing the "start/pause" button, and then starts by placing the kettle or pressing "start/pause" button again within the pause of 1 hour. The kettle will not perform the function program once again but the unfinished part before the pause.

Avoid the false operation

The function mode can be arbitrarily switched within the one minute' s work of the product according to the selected one. The function cannot be arbitrarily switched after one minute' s working to avoid unintentional operations. To press the "start/pause" button if you need to switch function, and then select the needed program after flashing.

Cold water protection

In the implementation of other functions in addition to the "warm milk" and "yoghourt", such as adding cold water during cooking, the product will automatically re-boil water and then implement the program that has not been completed. No need to worry about raw or cold.

Cleaning & Maintaining

Cleaning & Maintaining

Cleaning of the health kettle

1. Pull off the power plug.
2. A wet sponge is used for external cleaning after the product is completely cooled.
Caution: do not immerse the kettle, the base, the power cord or the plug in the water (the electronic connector on the bottom of the kettle and the base can' t touch the water).
3. Please clean in time after every use to avoid food deterioration.

Descaling

A regular scaling is needed for the product at least once a month, and the times should be increased if the water quality is poor. It belongs to the normal phenomenon for a spot appears on the heating plate, which is the scale and can be cleaned by using a clean cloth to scrub gently. The following way can be used for descaling if more serious.

Tips for descaling

Use white vinegar:

- Add appropriate amount of white vinegar into product
- Start the "boil " mode, and let it sit for 5-10 minutes after automatic power off.
- Empty the kettle and wash it for 5-6 times with clean water. Repeat if necessary.

Use lemon slices:

- Add 500ml water and 5g lemon slices to the kettle for 15 minutes.
- Start the "boil " mode and let it sit for 5-10 minutes after automatic power off.
- Empty the kettle and wash it for 5-6 times with clean water. Repeat if necessary.

"Any other servicing should be performed by an authorized service representative."

Simple Troubleshooting

Simple Troubleshooting

Troubles	Causes analysis	Troubleshooting
After installation, there is no prompt tone and the key lights are not on.	Power access failure	Check whether the socket is plugged properly or not.
	The kettle body is not connected to the base in place.	When the kettle body is put on the base, you can rotate or adjust the position to make sure that it is connected in place.
	Base failure	Sending to service point for maintenance is suggested.
The prompt tone continues to ring.	Dry burning protection (general key lights are all on).	After cooling for a few minutes, pour in cold water and continue using.
	NTC is abnormal	Sending to service point for maintenance is suggested.
After the kettle is heated for 10 seconds, it stops working. After 3 short sounds, it automatically shuts down.	Prompt of high temperature inside the kettle	In general, this situation will appear in the heat preservation, yogurt, warm milk and other functions. The water temperature in the kettle is higher than the temperature set in the program. Add cold water and continue working.
Peculiar smell in water	Unused new beverage maker	It is recommended to boil the water several times before using the new health kettle. If the situation persists, fill the water to the highest level, add two teaspoons of soda, pour out after boiling, and then clean the health kettle.

List of Environmental Protection

The names and contents of poisonous and hazardous substances or elements in the product

Parts name	Hazardous substance					
	Plumbum (Pb)	Mercury (Hg)	Cadmium (Cd)	Chromium VI (Cr (VI))	polybrominated biphenyls (PBB)	polybrominated diphenyl ethers (PBDE)
Kettle lid components	○	○	○	○	○	○
Kettle body components	○	○	○	○	○	○
Base components	○	○	○	○	○	○
Heating plate components	×	○	×	○	○	○
Circuit board components	×	○	○	○	×	×
Power cord	×	○	○	○	○	×

○: Means the content of hazardous substance in all homogeneous materials of the component is below the limit specified in GB/T 26572.

×: Means that the content of the toxic and hazardous substances at least in a homogeneous material of the component exceeds the limit specified in GB/T 26572.

	<p>Environment-friendly use period of 10 years: Means the hazardous substances contained in the product will not be leaked or mutated, and the normal use of product by user under the circumstances described in the product manual will not cause serious pollution to the environment or cause serious damage to the person or property of the user.</p> <p>Arrow circulation mark: Means the product can be recycled. It should not be thrown away at will after exceeding the service life or being unable to work properly after maintenance. Please send to the formal recycling channels and enterprises with the qualification of disposing waste electrical and electronic products for treatment. For the correct treatment method, please refer to the national or local regulations on the disposal of old electrical and electronic products.</p>
--	---

The above marks shall be implemented according to the administrative measures for restricting the use of hazardous substances in China and the supporting standards SJ/T 11364.

Warranty & Service

Warranty & Service instructions

Please refer to the warranty conditions and fill in the information if obvious damage of the product. The product will be returned to the authorized service center of Buydeem. The model and serial number can be found at the bottom of the product.

- The warranty is limited to production defects and damage due to the correct use based on the reference manual.
- It must be repaired or replaced by the manufacturer or professionals of the After Service Center to avoid danger if the power cord is damaged.
- The contact is service@pandabrands.com if need to purchase product parts after the warranty period has already elapsed.

The following conditions are not within the scope of free maintenance

- No Three Guarantees vouchers and valid invoices
 - Malfunction caused by the operation out of the required instruction.
- A. Damage caused by improper use, storage and repair of consumers.
 B. Damage caused by self disassembly and repair out of our designated maintenance department.
 C. Damage due to force majeure.

For the benefit of customers, Buydeem reserves the right to modify the product features and components to ensure the normal use of the product.

If need more service and information, or any question, please visit the Buydeem website of www.buydeem.com, or contact service@pandabrands.com or contact the local dealer. You can cut out the warranty card, fill in the information and send the product back to our company, which is solved by our professionals.



Warranty card

1. According to the "New Three Guarantees", the guarantee period is one year (from the date of issuing the invoice).
2. The invoice and guarantee certificate shall be used together as the warranty documents. The warranty will be invalid once the invoice has been altered.
3. Parts costs and labor costs will be charged for damage caused by improper use or other non-product quality problems.

Customer name _____ Contact telephone No. _____ Email _____

Address _____

Product model _____ Purchase date _____ Distributor _____

Serial No _____

Date	Cause	Repairmen

Pandabrands Inc.
 e-mail: service@pandabrands.com

感谢您购买北鼎产品，为了能让您充分享受北鼎全方位的支持，使用本产品之前请详细阅读本说明书及相关图解。

目录	Contents	
		使用产品 ————— 15~19
		初次使用 ————— 15
		快速安装 ————— 15
		使用指引 ————— 16
		特色功能 ————— 20~22
		清洁和保养 ————— 23
		简单故障处理 ————— 24
		环保清单 ————— 25
		保修和服务 ————— 26
		保修卡 ————— 27
注意事项 —————	04	
技术规格 —————	05	
认识产品 —————	06~14	
产品结构图 —————	06	
功能模式介绍 —————	07	
部件介绍 —————	10	

注意事项 / Notice

⚠ 危险

- 切勿在无人看管的情况下运行本产品，以防产品突发情况造成火灾等危险。
- 为防止触电或短路等危险，切勿将养生壶、底座、电源线及插头置于水中或其它任何液体中。

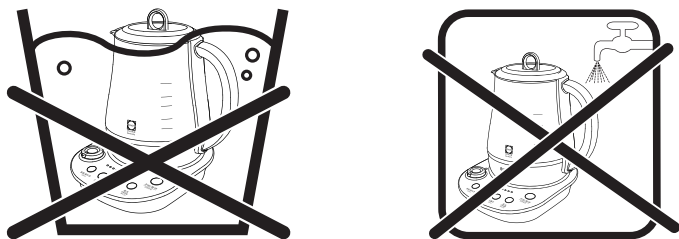

⚠ 警告

- 儿童、老年人、肢体或精神能力受限人士及无使用经验人士应在监督和指导下使用产品，并保证其安全。儿童应在监管下接触本产品，以确保他们不会将产品当成玩具玩耍。
- 本产品必须单独使用额定电流10A以上，额定电压120V~60Hz的接地插座，插头需完全插入插座，以防接触不良而导致元件过热烧坏，引发短路或火灾等危险。
- 切勿使用万能插座。
- 请将养生壶和电源线远离高温、明火、潮湿、光滑的台面或锋利的边缘，以防引起器件损坏、故障或火灾。
- 手沾水或赤脚时禁止使用养生壶。

⚠ 注意

- 本产品仅设计为家庭使用，厂商仅对生产瑕疵和家用故障进行保修；任何商业用途、不适合用途或未遵照说明操作而造成的后果与故障，厂商均不负任何责任，此等故障损坏均不属于保修范围内。
- 使用前请核对产品规格标贴上显示的电压与主电压是否一致。
- 本产品必须和其配套的底座一起使用，请勿使用其它底座。
- 请始终将养生壶放置在平坦、稳固、耐热的工作台上。
- 使用产品前，请务必确认上盖已正确盖好，以防烫伤。

注意事项 / Notice

⚠ 注意

- 养生壶在工作期间会产生高温和蒸汽，请勿在工作期间以非正确方式揭开壶盖、触碰或移动养生壶、靠近蒸汽出口等高温部分，以防烫伤。
- 请勿将密闭的容器放置在壶内加热，以防引起爆炸的危险。
- 请勿在超过最大水位或低于最低水位的情况下运行养生壶；养生壶内装水或食材过满，可能会引起沸水溅出，养生壶内装水或食材过少，可能会引起干烧和糊底。
- 养生壶要防潮、防冻，请勿将养生壶放进冰箱。
- 为防止触电或火灾，请保证下列情况下电源是断开的：空壶时、不使用养生壶时、清洁或移动养生壶时、养生壶部件损坏时、当养生壶出现故障时。
- 如果长时间不使用养生壶，建议将养生壶内的水倒掉。
- 如需拔下插头，请手握住插头再拔出，请勿强行拉扯或扭曲电源线，以防电源线损坏，产生漏电危险。
- 请不要让电源线悬挂在桌子或工作台面边缘之外，以防养生壶摔落，或引起绊倒。
- 请不要用非推荐的方法除水垢，推荐方法详见P23。
- 如发现养生壶部件损坏或不能正常工作时，请立即拔掉电源插头，切勿继续使用，也请勿自行拆除，请前往北鼎授权的服务中心进行更换或维修。
- 除了按照说明书进行清洁和除垢，其它任何非正常使用操作必须由北鼎授权的服务中心进行。
- 由于未对养生壶进行除垢造成其不能正常使用或完全不能使用的，不属于保修范围。
- 因为所有产品均严格按照质量控制程序，其中包括对随机抽检产品的实际使用测试，所以其将对产品的任何使用痕迹作出解释。

技术规格

产品名称：多功能电水壶（养生壶） 产品型号：K2693 产品功率：1000W 电压：120V~60Hz 最大容量：1.5L

本产品采用食品接触用材质：德国肖特玻璃、SUS304 (06Cr19Ni10) 及 SUS316L (022Cr17Ni12Mo2) 不锈钢、聚丙烯PP塑料、食品接触用硅胶

认识产品 / Understanding Product

产品结构图

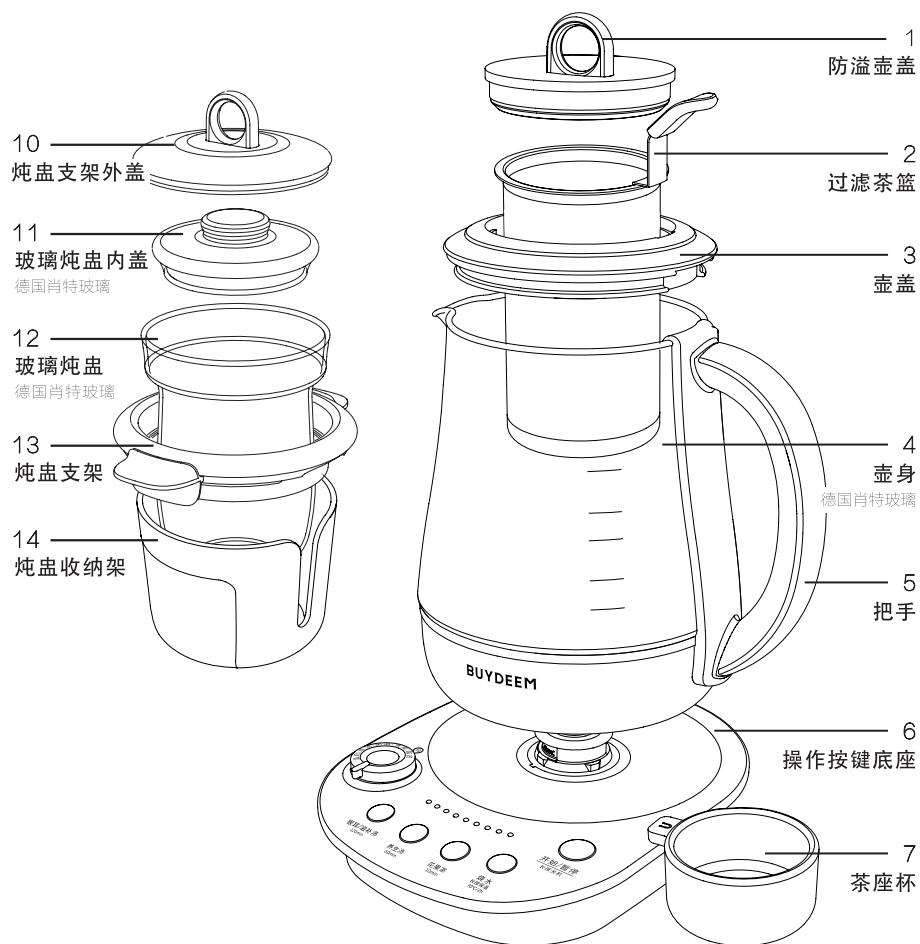

认识产品 / Understanding Product

功能模式介绍

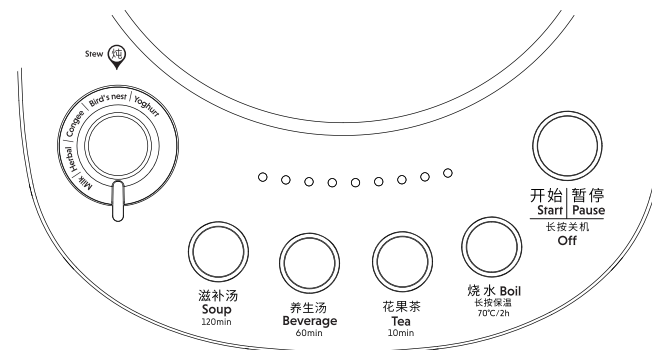

功能类型	功能名称	适煮食材	功能运作方式
基础功能	开始/暂停	/	按下此按键, 养生壶开始/暂停工作。 长按2秒停止工作。
	烧水	/	快速烧水至沸腾后停止工作。请勿用此功能键加热除水外的汤汁/液体, 否则可能出现溢出现象。
	手动保温	/	将水温维持在70°C, 2小时。保温状态下, 灯圈为呼吸灯。当壶内温度高于70°C时, 养生壶将待水温降至70°C后再进行保温。
煮功能按键	花果茶 (10分钟)	花草茶、水果茶、 中式熟茶等	水烧开后按照花果茶模式工作10分钟。 程序结束后, 养生壶自动保温70°C, 2小时。
	养生汤 (60分钟)	豆类、红枣、莲子等	水烧开后按照养生汤模式工作60分钟。 程序结束后, 养生壶自动保温70°C, 2小时。
	银耳/滋补汤 (120分钟)	银耳、皂角米、薏米等	水烧开后按照银耳/滋补汤模式工作120分钟。 程序结束后, 养生壶自动保温70°C, 2小时。

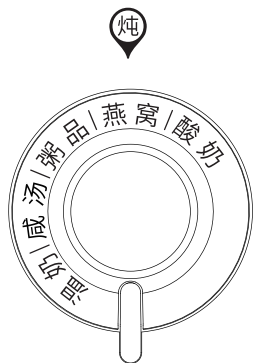

功能类型	功能名称	适煮食材	功能运作方式
炖功能旋钮 (配合炖盅使用)	温奶 (60°C/10分钟)	温热牛奶	先加热壶中水至60°C后按照温奶模式保温10分钟。
	咸汤 (120分钟)	炖虫草花, 花胶, 骨汤等汤品	水烧开后按照咸汤模式工作120分钟。程序结束后, 养生壶自动保温70°C, 2小时。
	粥品 (60分钟)	炖五谷粥, 蔬菜粥等粥类	水烧开后按照粥品模式工作60分钟。程序结束后, 养生壶自动保温70°C, 2小时。
	燕窝 (30分钟)	炖燕窝等汤水	水烧开后按照燕窝模式工作30分钟, 无自动保温功能。
	酸奶 (40°C/8小时)	制作酸奶	会先加热壶中水至40°C后按照酸奶模式保温8小时。若养生壶内水温过高, 选择“酸奶”功能时, 养生壶会短鸣五声后自动停止工作。

灯带进度条

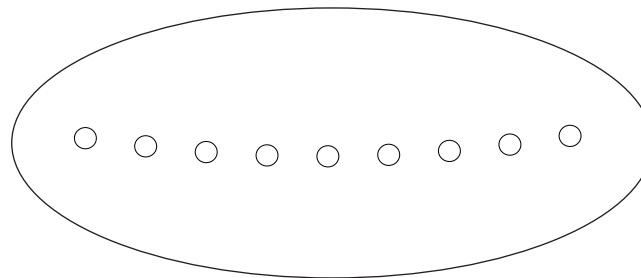

当养生壶启动烹煮程序时, 灯带会从左到右随着烹煮功能的完成进度逐渐亮起灯源, 用户可以通过灯源显示状态判断烹煮进度。

功能类型	灯带进度条运作方式
烧水	灯带代表壶内温度完成情况。
保温	养生壶处于保温状态时, 灯源熄灭。
其他烹煮功能	灯带代表的是温度和烹煮时间的进度。第一颗灯亮起时, 代表壶内茶汤已是烧开状态, 剩余的8颗灯代表时间的进度。

部件设计

防溢壶盖设计

- 养生壶按照用户日常使用习惯，加入两个盖子相互嵌套的“防溢壶盖”独特设计。
- 在养生壶正常工作时，用户可以随时拧开防溢壶盖来观测食物烹煮状态，从而选择进行加料或调味等各种操作。
- 若食物烹煮时产生过多的泡沫，建议打开防溢壶盖，可有效防止溢出情况的出现。

1. 防溢壶盖安装：

- 握住提手抵住壶盖，顺时针旋转拧紧即可。

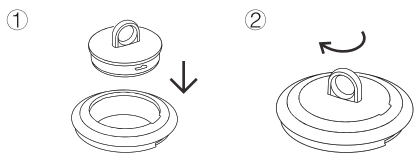

2. 防溢壶盖拆卸：

- 握住提手抵住壶盖，逆时针旋转拧开即可。

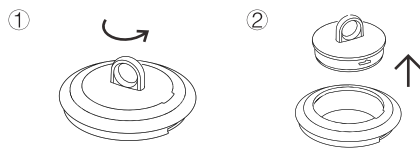

过滤茶篮设计

- 为了方便用户过滤不食用的食材/茶叶，养生壶加入提手式茶篮的独特设计。
- 在烹煮过程中，用户可将不食用的食材放入茶篮中；若担心味道过浓，可在烹煮过程中打开茶篮盖，将茶篮取出。

1. 过滤茶篮安装：

- 抓住茶篮提手，把茶篮放入壶盖中空部分；
- 顺时针拧紧茶篮盖，当听到一声轻微“啫啫”声时，表示已经拧紧；
- 将整个盖子放入养生壶安装在壶口，滤网对准壶嘴，轻轻按压使壶盖合紧。

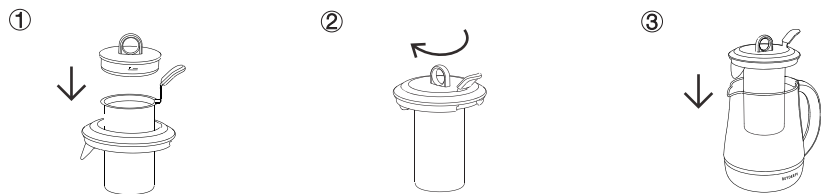

2. 过滤茶篮拆卸：

- 把茶篮盖逆时针拧开；
- 抓住茶篮提手，提出茶篮。

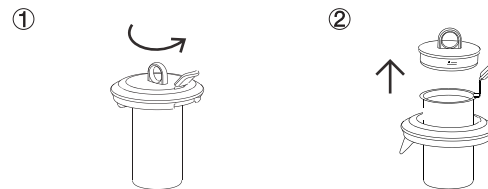

茶座杯设计

- 为了方便用户放置及收纳茶篮，养生壶加入茶座杯的独特设计。
- 茶座杯具有专利磁铁结构，可180°吸附底座，防止丢失。
- 茶篮从养生壶中取出时，可放置在茶座杯中，防止茶篮滴水沾湿桌面。

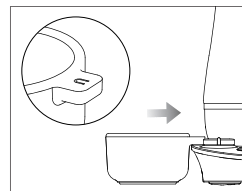

玻璃炖盅设计

- 养生壶为满足用户更全面的日常需求,另外加入了支架式炖盅的独特设计。
- 用户可通过炖盅隔水炖煮食物,玻璃材质炖盅可直接观测食物烹煮状态。

注意:

- 使用炖盅时,请勿进行倒水操作,以防炖盅与支架掉落造成烫伤危险。
- 请勿将玻璃炖盅直接明火加热。
- 请勿将玻璃炖盅放入烤箱或微波炉内加热。
- 炖盅的有效最大容量为500ml(约炖盅高度7成),使用时请勿超出最大容量,以免使用过程中食材溢壶造成烫伤。

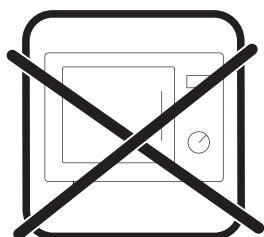

1. 玻璃炖盅安装:

- 将食材放入炖盅内并盖上玻璃内盖;



- 将炖盅放到支架内;



- 将支架连炖盅一起提起;



- 将炖盅安装在壶口,当支架三角标识对齐壶嘴和把手时,说明已经安装完成;

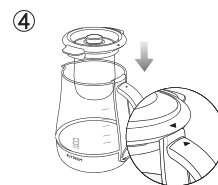

- 盖上炖盅支架外盖即安装完成。



2. 玻璃炖盅拆卸:

- 提起支架,连同炖盅取下;



- 轻轻放下支架;

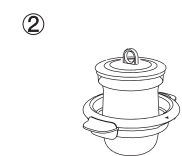

- 拿开支架外盖;

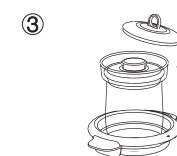

- 取出炖盅;

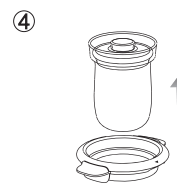

- 取下玻璃炖盅内盖,即可食用。

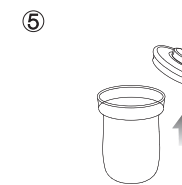

认识产品 / Understanding Product

炖盅收纳设计

- 为方便用户收纳和晾晒炖盅，养生壶加入炖盅收纳架的独特设计。
- 用户可在使用完炖盅后将炖盅置于收纳架中晾干；晾干后可将炖盅放置在收纳架中收纳。

1. 晾晒炖盅：

- 洗净炖盅后，先将玻璃内盖放入收纳架；

①



- 依次放下炖盅支架和炖盅支架外盖；

③

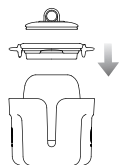

- 倒扣玻璃炖盅；

②

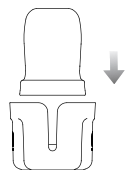

- 将炖盅及炖盅支架如图所示放置直至晾干。

④



2. 收纳炖盅：

- 将炖盅放入支架内；

①

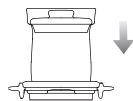

- 将支架与炖盅提起一起放入收纳架内，再放入支架外盖。

②

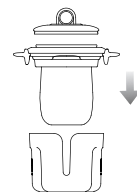

使用产品 / Using Product

一、初次使用

1. 去除养生壶内外所有包装，标签及附件。
在初次使用产品之前，我们建议您做一次沸点检测操作（详见P20）。

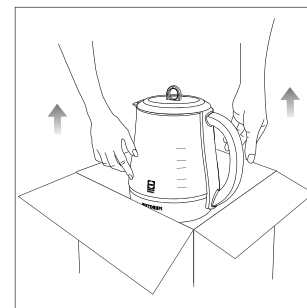

2. 前2-3次煮水应该倒掉用于清洁，然后用湿布擦拭养生壶部件的外部（请注意壶底和底座上的电子连接器不可接触水）。

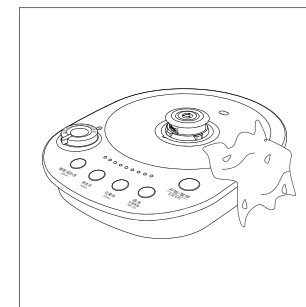

二、快速安装

1. 通过底座的绕线装置调整电源线的长度。

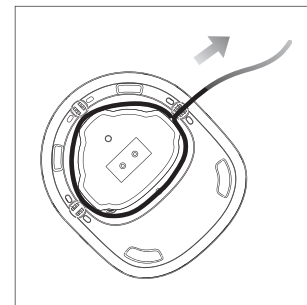

2. 将养生壶放到底座上。



三、使用指引 煮

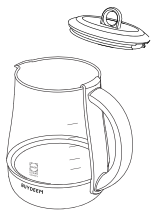

1. 打开壶盖

- 拉紧防溢壶盖提手, 向上拉即可取出壶盖。



2. 加入适量的净水

- 当养生壶在底座上时请勿加水。



3. 加入食材

- 切勿加水 and 食材超过最大水位或低于最小水位。
- 若加水过满, 沸腾时可能会溅出水。
- 请注意, 对于银耳、黄芪、黑茶等容易起泡的食材, 建议加水到1000ml水位线即可, 并在烹煮时打开防溢壶盖。

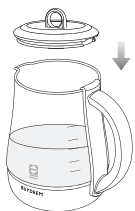

4. 盖紧壶盖

- 将壶盖按图示位置放在壶身上, 轻轻按压使壶盖合紧, 用手轻轻提起, 若提不起, 表示盖子合紧。
- 如盖子装配不到位, 倒水时, 盖子容易掉下来。
- 请注意! 盖紧壶盖时, 请确认壶嘴滤网是否对准壶嘴, 否则, 说明壶盖没盖紧。



5. 将养生壶放在底座上

- 请将壶底及底座面上的水擦干。
- 底座务必放置在平坦、干净的耐热台面上。
- 养生壶壶身必须使用专属的底座。
- 养生壶内无水时请勿使用。

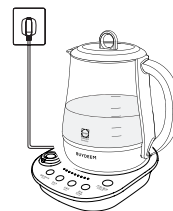

6. 插上电源

- 当养生壶通电, 蜂鸣器发出响声, 按键灯闪烁后灯灭, 表示进入待机状态, 可开始选择功能工作。

炖



1. 在玻璃炖盅里加入食材

- 将食物放入炖盅内, 加入适量的水, 按P13页所示安装好炖盅。



2. 在养生壶里加入适量净水

- 加水至养生壶刻度1000ml (放盅前水位)。
- 当养生壶在底座上时请勿加水。

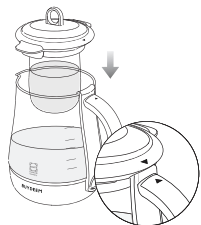

3. 安装壶盖

- 将支架连炖盅提起, 安装在养生壶上。
- 请注意! 请确认支架上三角标识对齐壶身把手上的三角标识, 否则说明炖盅支架没安装好。

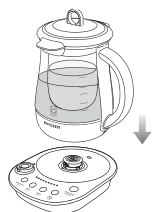

4. 将养生壶放在底座上

- 请将壶底及底座面上的水擦干。
- 底座务必放置在平坦、干净的耐热台面上。
- 养生壶壶身必须使用专属的底座。
- 养生壶内无水时请勿使用。

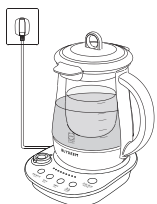

5. 插上电源

- 当养生壶通电, 蜂鸣器发出响声, 按键灯闪烁后灯灭, 表示进入待机状态, 可开始选择功能工作。

功能模式使用指引

煮功能使用指引(银耳/滋补汤 养生汤 花果茶 烧水)

step 1: 选择左图中任一按键, 如烧水

step 2: 按“开始/暂停”按键, 即可开始对应功能模式

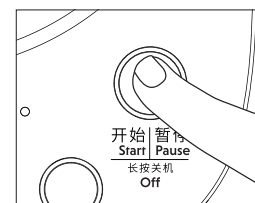
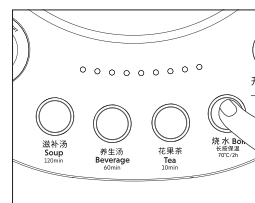

手动保温功能使用指引

step 1: 长按“烧水/长按保温”按键2秒至灯圈显示呼吸灯

step 2: 按“开始/暂停”按键, 即可开始保温模式

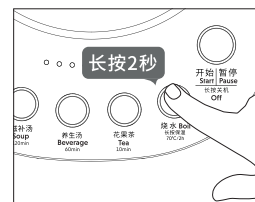

炖功能使用指引(酸奶 燕窝 粥品 咸汤 温奶)

step 1: 旋转左图中旋钮, 使选定功能对准“Ⓢ”标识处

step 2: 按“开始/暂停”按键, 即可开始对应炖功能模式

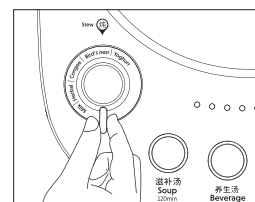

特色功能 / Features

沸点检测记忆程序

- 由于在非零海拔地区,水在沸腾时无法达到100°C,这将导致普通养生壶无法正常工作(跳断过慢甚至无法正常跳断)。
- 北鼎建议您在第一次使用时,均进行一次沸点检测操作。检测完成后,芯片将记录精确沸点数据,再次使用无需重复检测。
- 经过沸点检测后,养生壶能更精准地工作(性能比出厂设置时更佳)。

* 若您处于海拔高于250m的城市,请必须进行沸点检测操作后再使用。

启动沸点检测

1. 加水至刻度线1200ml处,水量不足或过多时,会影响检测结果。



2. 放入底座,先不通电。



特色功能 / Features

3. 同时按住“花果茶”和“烧水”按键,按稳后再将电源插头插入电源,听到机器短鸣一声后,方可松开手指。

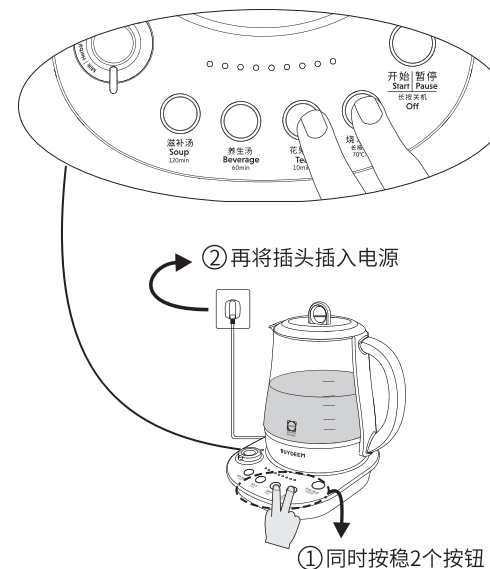

4. “开始/暂停”灯圈闪烁,按一下“开始/暂停”键,所有按键指示灯轮番闪烁。此时机器已进入检测状态。检测完成后机器长鸣三声,自动结束工作并进入待机状态。

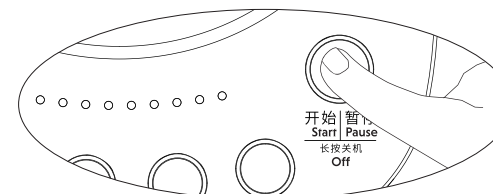

特色功能 / Features

壶暂停记忆功能

养生壶按照程序进行工作时,可通过提壶或按“开始/暂停”来使其暂停工作,暂停1小时内再通过放壶或按“开始/暂停”来开始工作,养生壶将执行暂停前未完成的程序时间,不会重新执行一遍功能程序。

避免误操作

养生壶按照所选功能模式进行工作的1分钟内可任意切换模式;

为了避免误操作,养生壶开始工作1分钟后,不能随意切换功能。若需要切换功能,需先按“开始/暂停”按键,“开始/暂停”按键闪烁,再选择需要切换的程序。

冷水保护

在执行除“温奶”和“酸奶”的其他功能时,如在烹煮中途加入冷水,养生壶会自动重新将水烧开后再执行未完成的程序,无需担心生冷隐患。

清洁和保养 / Cleaning & Maintaining

清洁和保养

养生壶的清洗

1. 拔下电源插头。
2. 待水壶冷却后,用湿海绵清洗养生壶内部。
注意:切勿将养生壶、底座、电源线或插头浸泡水中(壶底及底座上的电子连接器不可接触水)。
3. 每次使用后,为避免食物变质,请及时清洗。

除水垢

养生壶需定期除水垢,建议每月一次,如水质较差则应增加除垢频率。

发热盘如出现斑点,此为水垢,属于正常现象,用百洁布轻轻擦洗即可清洗干净。

若情况较为严重,可采用以下方式进行除垢。

养生壶除垢小贴士

使用白醋:

- 养生壶中加入适量的白醋。
- 启动“烧水”模式,待自动断电后,静置5-10分钟。
- 倒空养生壶后用清水清洗5-6次,必要时可重复。

使用柠檬片:

- 在养生壶中加入500ml清水并加入5克柠檬片,静放15分钟。
- 启动“烧水”模式,待自动断电后,静置5-10分钟。
- 将水倒掉后,用清水清洗5-6次,必要时可重复。

简单故障处理 / Simple Troubleshooting

简单故障处理

故障现象	原因分析	故障排除
安装后,无提示声音且按键灯不亮	未接通电源	检查插座是否已插好
	煲身与底座没有连接到位	煲身放上线座后,可旋转或调整位置,确认已连接到位
	线座故障	建议送服务点维修
提示音持续响	干烧保护(一般按键灯全亮)	冷却数分钟后,再倒入冷水继续使用
	NTC异常	建议送服务点维修
壶加热10秒后停止工作,短鸣3声后自动关机	壶内水温高温提示	一般此情况会出现在保温、酸奶、温奶等功能,壶内水温高于程序设定的温度,加入冷水再继续工作。
水有异味	未使用过的新养生壶	新养生壶使用前建议煮几次水倒掉,如果状况持续发生,将水注满至最高水位,并加两茶匙的苏打,煮沸后倒掉,再清洗养生壶。

环保清单 / List of Environmental Protection

产品中有毒有害物质或元素的名称与含量

部件名称	有害物质					
	铅(Pb)	汞(Hg)	镉(Cd)	六价铬(Cr(VI))	多溴联苯(PBB)	多溴二苯醚(PBDE)
壶盖组件	○	○	○	○	○	○
壶身组件	○	○	○	○	○	○
底座组件	○	○	○	○	○	○
发热盘组件	×	○	×	○	○	○
电路板组件	×	○	○	○	×	×
电源线	×	○	○	○	○	×

○:表示该有害物质在该部件所有均质材料中的含量均在GB/T 26572规定的限量要求之下。

×:表示该有毒有害物质至少在该部件的某一均质材料中的含量超出GB/T 26572规定的限量要求。

	<p>环保使用期间10年:表示本产品中含有的有害物质不会发生外泄或突变,用户在产品说明书所述情况下正常使用本产品不会对环境造成严重污染或对其人身、财产造成严重损害的期限。</p> <p>箭头循环标志:表示本产品可回收利用。超过使用期限或经过维修无法正常工作后,不应被随意丢弃,请交由正规回收渠道以及有废弃电气电子产品处理资格的企业处理,正确的处理方法请查阅国家或当地有关旧电器电子产品的处理规定。</p>
--	--

以上标识均依据中国有害物质限制使用管理办法及其配套标准SJ/T 11364要求执行。

产品长期使用不会对人体产生危害,请放心使用。

保修和服务 / Warranty & Service

保修和服务说明

如果产品有明细损坏,请您参看保修条件填好资料,将产品退回北鼎授权的售后服务中心修理,产品型号及序列号可见于产品底部。

- 保修仅限生产缺陷及参照说明书正确使用造成的损坏。
- 如果电源线损坏,为避免危险,必须由生产商、售后服务中心的专业人员进行维修或更换。
- 已过保修期限的顾客,如需购买产品零配件,可联系service@pandabrands.com

以下情况恕不免费维修

- 无三包凭证及有效发票
 - 未按说明书的要求操作引发的故障
- A. 消费者使用、保管、维护不当造成的损坏。
B. 非本公司指定维修部自行装拆修理而造成的损坏。
C. 因不可抗力造成的损坏。

为了客户的利益,北鼎保留对产品特性及组件做出修改的权利,以确保产品的正常使用。

如果你需要更多的服务和信息,或有任何疑问,请访问北鼎网站www.buydeem.com,或联系service@pandabrands.com,或与当地经销商联系,你也可以剪下保修卡填写资料,将产品寄回本公司,由本公司专业人员为你解决



保修卡

- 1.根据“新三包”规定整机保修期为一年(自开具发票之日起)。
- 2.发票和保修证书一同作为保修凭证,发票一经涂改,保修即失效。
- 3.因使用不当或其他非产品本身质量问题造成的损坏,将收取零件成本及人工费。

顾客姓名 _____ 联系电话 _____ 邮 箱 _____
地 址 _____
产品型号 _____ 购买日期 _____ 经销商 _____
机身号码 _____

日期	原因	维修员

Pandabrands Inc.
e-mail: service@pandabrands.com



BUYDEEM

深圳市北鼎科技有限公司

K2693-91-A1

产品如有细微改动, 请以实物为准
使用本产品之前请仔细阅读本说明书
并请妥善保管

更多请登陆www.buydeem.com

Shenzhen Buydeem Technology Co., Ltd.

K2693-91-A1

Please in kind prevail in case of minor changes
Please read this instruction carefully before use
and keep it properly

Visit www.buydeem.com for more information.