



MPM18 • TALYLLYN RAILWAY Co. GUARD'S BRAKE AND LUGGAGE VAN NO 5

HISTORY

Constructed by Brown, Marshall & Company in 1866, No. 5 is a combined guard's brake and luggage van suited to all types of train. As originally built it had an open verandah on the brake compartment. Later modifications included the fitting of duckets (lookouts) and the filling in of the open-ended brake section. Also the removal of the sliding doors and ductet on the south facing non-platform side. The ductet on the platform side also formed the unique booking office window.

This kit will reproduce all versions of the van from 1866 to the 1950s, and with modifications by the builder of any version to date. Referral to the recommended publications is advised for further details.

BUILDING NOTES

The exploded diagram shows the assembly stages in detail, but the following notes will be of use. Please read these thoroughly before commencing and decide which version you wish to build.

Remove parts from the 'sprues' with care, cutting off with a sharp knife or side cutters. Never break them off by bending. Carefully sand away any remaining flash or moulding marks with fine grade wet and dry papers. A fluid solvent, for example Slaters Mekpak, is recommended for this kit applied with a fine brush.

VARIATIONS

Before starting construction of this model you must decide which version is required. The main variations are listed below:

- 1 • Circa 1866 – As built, with two sliding doors, footboards on both sides an open platform with no door in division between van section. (*Photo; page 51*)
- 2 • Pre-1900 – Platform closed in with boarding and sliding panel to reach brake handle, also doorway formed in division.
- 3 • Circa 1911 – Boards over fixed platform doors removed and duckets fitted to both sides together with a small canopy over the brake handle. (*Photo; Page 287, top*)
- 4 • Circa 1935 – Sliding door removed from south (non-platform) side. (*Photo; Page 289*)
- 5 • 1938/9 – Footboard on south (non-platform) side removed. (*Photo; Page 287, middle*)
- 6 • 1941 – Ducket on south (non-platform) side removed and opening boarded over. (*Photo; Page 210*)

Note: The brake platform is at the eastern end of the van. All photos listed are in "THE TALYLLYN RAILWAY" by J.I.C. Boyd. See bibliography.

COUPLINGS

The Greenwich Coupling system of auto-magnetic coupling

is highly recommended for this kit and all small scale narrow gauge models. It offers hands-free shunting and is designed to be compatible with other popular designs.

Greenwich couplings are available from Narrow Planet, Dundas Models and other narrow gauge suppliers.

Provision for mounting BEMO couplings (not supplied) is by raised bosses on the underside of the floor. Fix in place with epoxy resin or UHU type glue. If using BEMO coupling it will be necessary to file off the underside of the loops to clear the rail head.

BUFFERS

Lost wax brass castings of the correct type are supplied, Brown, Marshall two bolt fixing. Gently push fit into the buffer beam and secure with cyano (super-glu) as required.

PAINTING NOTES

Talyllyn Railway Co.

Ends and framing on sides • Dark Chocolate Brown
Sides, Doors and louvres • Dark Red/Crimson Lake
Underframe, Axle Boxes, springing, buffers/beams, ironwork and roof • Black or Dark Grey

BIBLIOGRAPHY

Study of the following is recommended

Talyllyn Railway Locomotives & Rolling Stock

Bate, Mitchell and Adams
Cheona Publications
ISBN 1 900298 21 X

The Talyllyn Railway

Boyd, J. I. C.
Wild Swan Publications Ltd.
ISBN 0 906867 46 0

This is highly recommended as the best source of reference to the history and development of the Talyllyn Railway from 1865 to 1951. The book is profusely illustrated with photographs and drawings. Together with highly readable text by author James Boyd makes this the standard work on the 'Old Company'.

STAGE 1

Modifying parts.

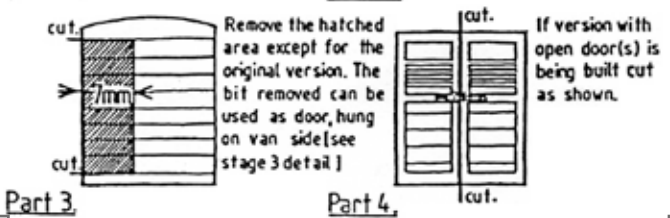
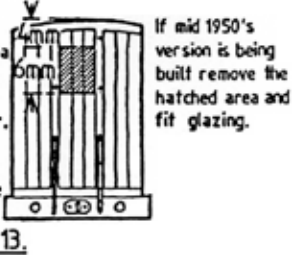
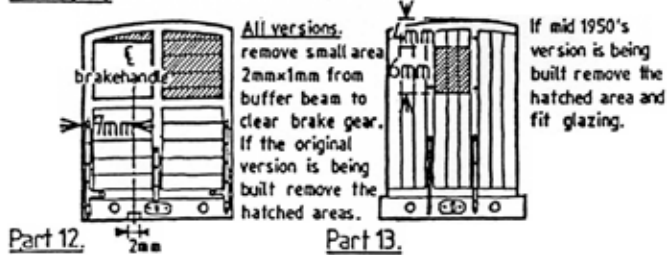
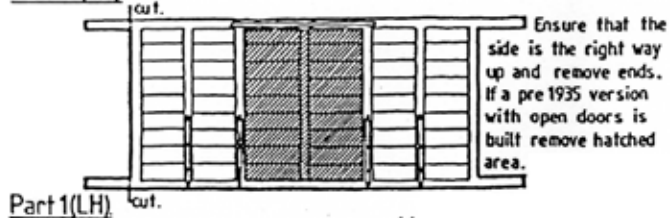
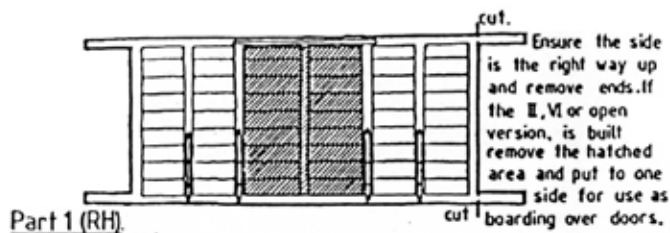

STAGE 2

Chassis.

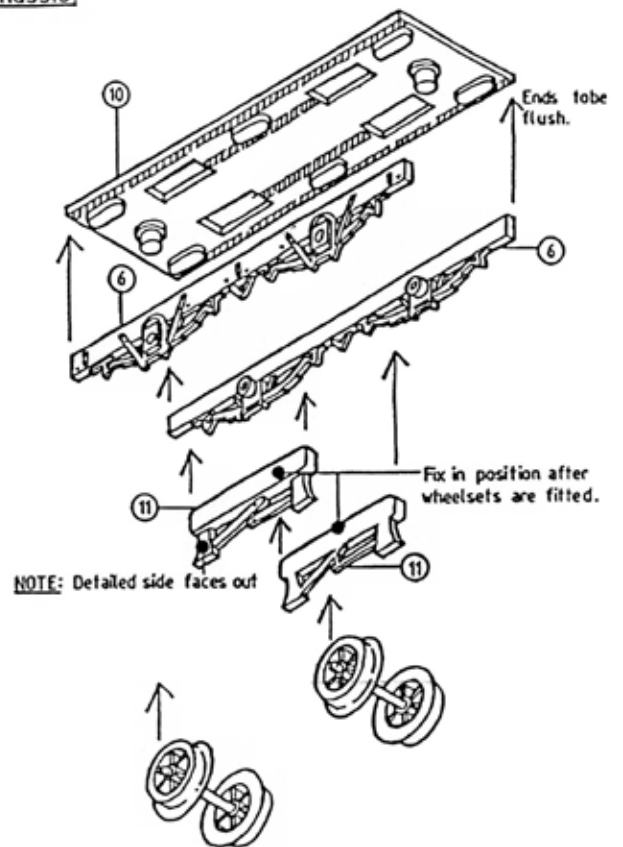

STAGE 3

Body.

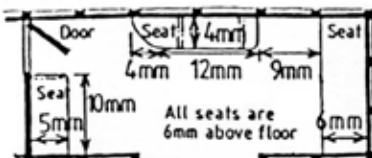

Sketch: Van interior.

NOTE:
Fit roof only when any interior fittings or painting is complete.

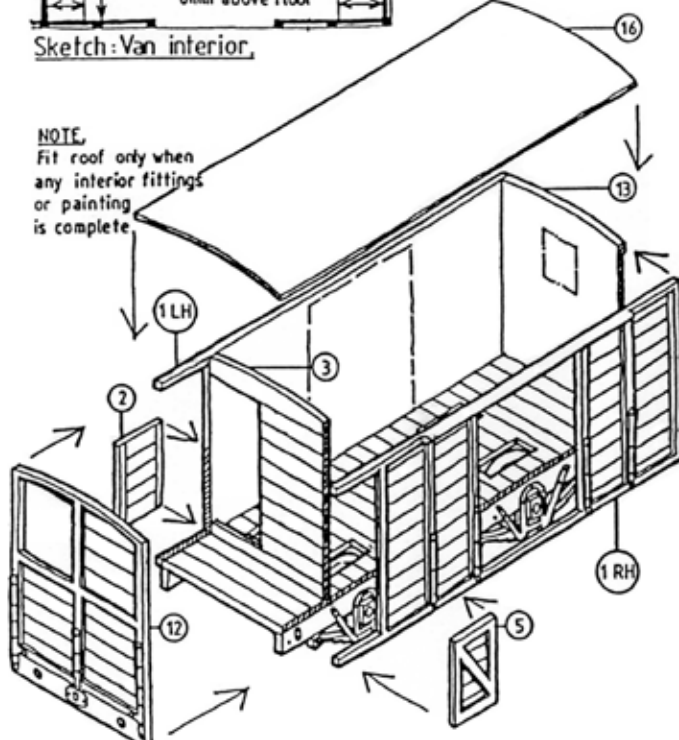

STAGE 4

Details.

This ductet was fitted from 1911 until 1941. Assemble and paint before fixing glazing material with 'EVO-STIK' resin 'W' when complete mount on side.

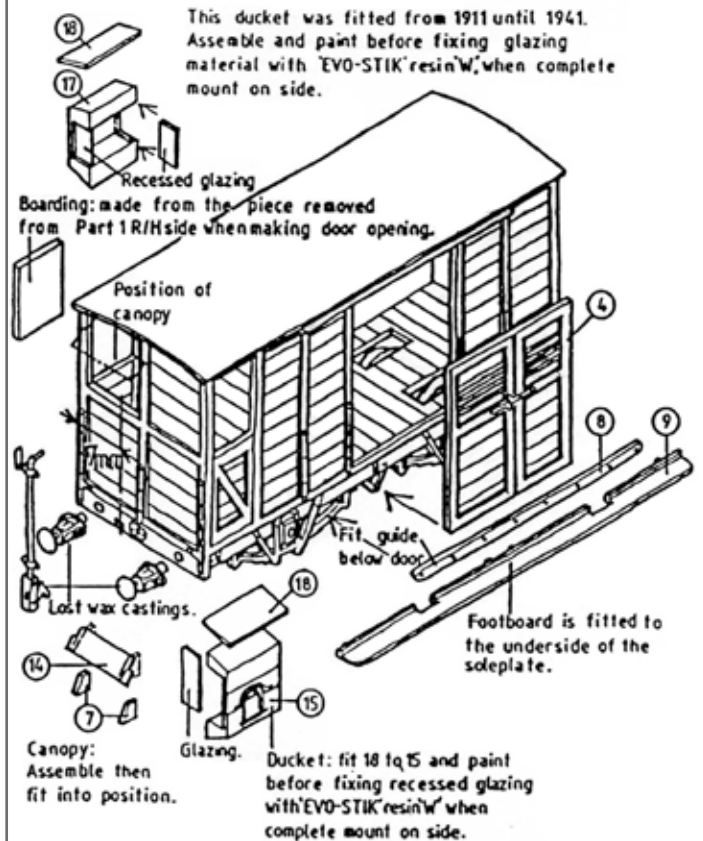

Now fit coupling of your choice — None are supplied

ABOUT MERIDIAN MODELS

Founded in 1973 and driven forward by the late Dave Brewer of the Greenwich & District Narrow Gauge Railway Society (G&DNRS), with Pete Wilson and other collaborators joining along the way, Meridian Models grew into a well-respected producer of detailed locomotive and rolling stock kits in 009.

Following Pete Wilson's decision to retire in 2015, Narrow Planet has taken on the production and distribution of the plastic rolling stock kits of the Meridian range. If you have any queries about the model or instructions please get in touch.

We are grateful for assistance of fellow members of the TRPS in the preparation of this kit. Our thanks also to Paul Karau of Wild Swan Publications Ltd. for kind permission to reproduce the scale drawings from James Boyd's book.

CONTACT DETAILS

www.narrowplanet.co.uk
info@narrowplanet.co.uk

Narrow Planet, PO Box 297,
Bexhill-on-Sea, TN40 9HF

MPM18 • first issue • January 2018

The parts.

- | | |
|-------------------|---------------------|
| 1. Side. | 10. Floor. |
| 2. Door (LH). | 11. Brakegear. |
| 3. Partition. | 12. Platform end. |
| 4. Sliding doors. | 13. Van end. |
| 5. Door (RH). | 14. Canopy. |
| 6. Chassis side. | 15. Ticket ductet. |
| 7. Canopy end. | 16. Roof. |
| 8. Door guide. | 17. Ducket. |
| 9. Footboard. | 18. Ducket roof (2) |

Sprue A (2off)

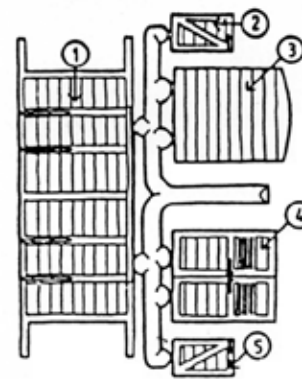

Sprue B (2off)

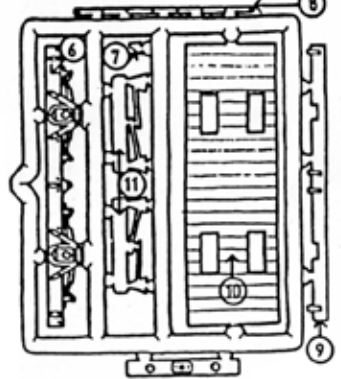

Lost wax castings.

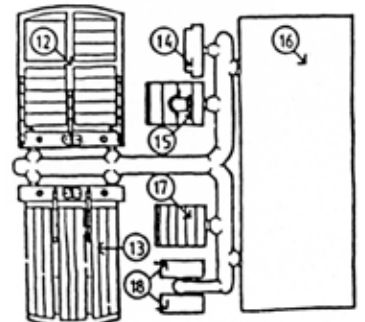
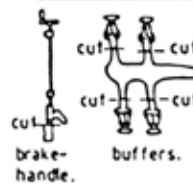

NOTE: Couplings are not supplied Sprue C (1)

