

STL-22 Light Duty Steel Shore with Patented Roller Bearing Nut and Safety Lock Set Screw.

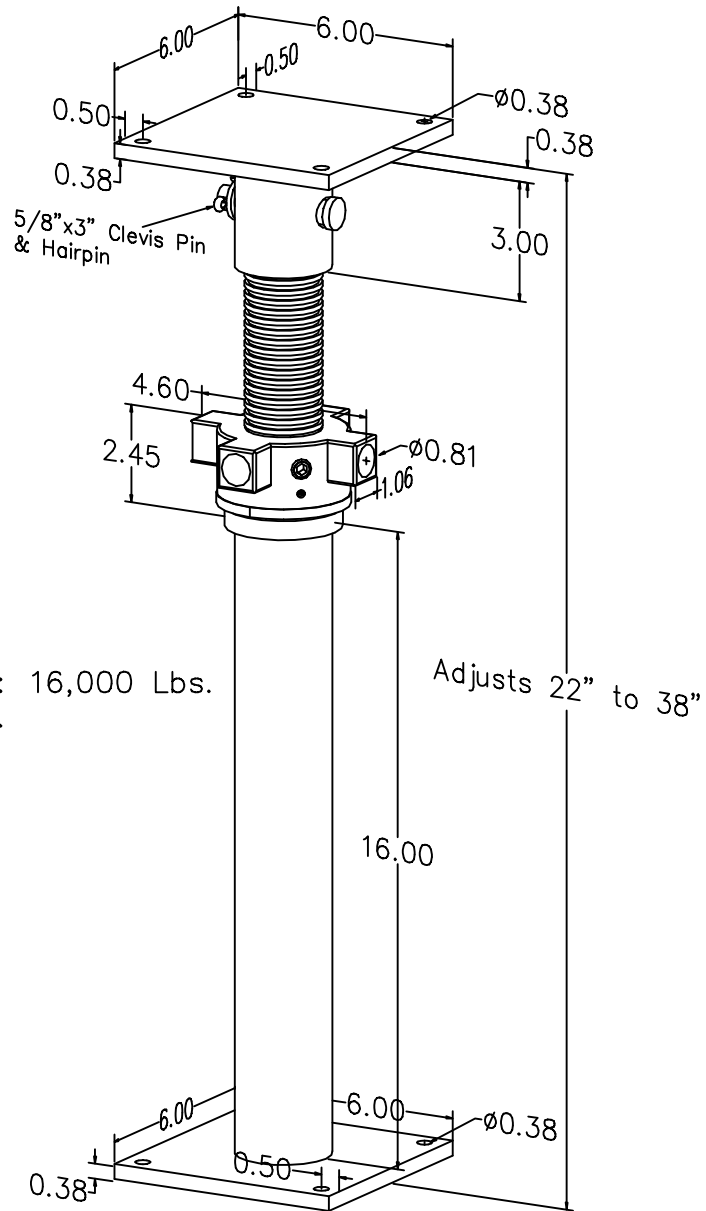

Item # STL-22
Adjusts 22" to 38"
Safe Load Capacity: 16,000 Lbs.
Weight: 22 Lbs. Ea.
MADE IN USA

Use Turning Bar as lever for height adjustment (Item # MJ-TB12, MJ-TB24, MJ-TB36).

DO NOT EXCEED SAFE LOAD CAPACITY.

© 2019 ELLIS MANUFACTURING CO., INC.