

Safety information before using VUEROID Dashcam

Warning

Do not expose product to rain, moisture or water under any circumstances, it may result in the risk of electric shock or fire.

Caution

To reduce the risk of electric shock, do not perform any servicing other than that contained in this instruction unless you are qualified to do so. Please make sure to have the product serviced by a qualified service technician if you are facing with some cases as follows;

1. Product has been exposed to rain or water.
2. Product does not seem to operate normally.
3. Product shows a marked change in performance.

VUEROID does not warrant any defects that can be caused by owner's fault. VUEROID is not responsible for any damaged that occur while driving.

Items included in the package



Dashcam



Rear Camera



Hardwiring Cable
(3m/9.8ft)



Rear Camera Cable
(6m/19.6ft)



Quick Manual

Option



MicroSD Card



SD Card Adaptor & Case



12V Power Cable

Part names

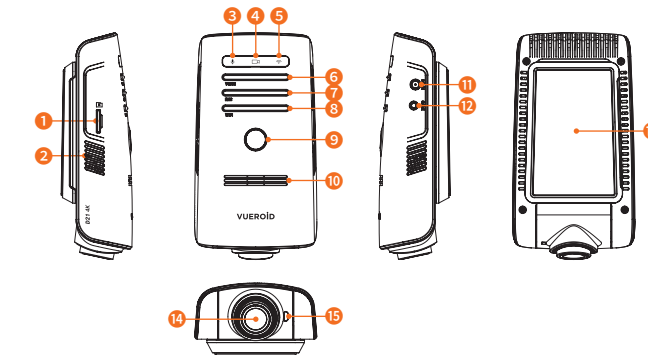

Part	Function
1 Memory card slot	A slot for a memory card
2 Microphone	Voice recording
3 Voice LED (↓)	Indicates voice status
4 Recording LED (□)	Indicates manual recording status
5 Wi-Fi LED (📶)	Indicates Wi-Fi status
6 Voice button	Voice recording ON/OFF/Event mode only/ Event+Parking mode only (Press only once)
7 Manual recording button	Voice guidance ON/OFF (Press more than 3 seconds)
8 Wi-Fi button	Wi-Fi ON/OFF (Press only once) Wi-Fi frequency switch 5GHz/2.4GHz (Press more than 3 seconds)
9 Power button	Power ON/OFF (Press more than 2 seconds)
10 Speaker	Voice guide and alert sound
11 DC-IN power port	Connect power cable
12 CAM input port	Connect rear camera
13 Mount bracket	Installation mount
14 Front camera lens	Front view recording
15 Front LED	Indicates parking status and provides security effect

⚠️ **Format memory card manually: Press Voice and Wi-Fi buttons simultaneously for more than 3 seconds.**

Key features

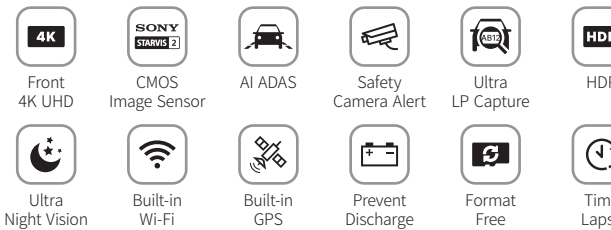

Installation

Caution

- Make sure to install a device in a safe area and make sure the vehicle is turned OFF.
- Check if the MicroSD Card is inserted correctly before connecting to a power.
- Make sure the installation area is clean.
- Unplug the DC power if you are not using the device for a long period of time.
- Do not drop the product as it may not function properly.
- During extreme high temperatures or in a hot weather season, parking indoor is suggested.

Inserting MicroSD Card

- Do not apply excessive force on the MicroSD card or insert in the wrong direction. Any actions which may cause a MicroSD card error, will be the responsibility of the user.
- Please test MicroSD card for errors frequently because it is a consumable item, it should be replaced periodically.
- Make sure the Dashcam is turned off when you remove the MicroSD card.
- Any problems arising from the use of MicroSD cards other than VUEROID are responsibility of the user.
- Periodically back up the important recorded files on other storage devices.

1. Installing front camera

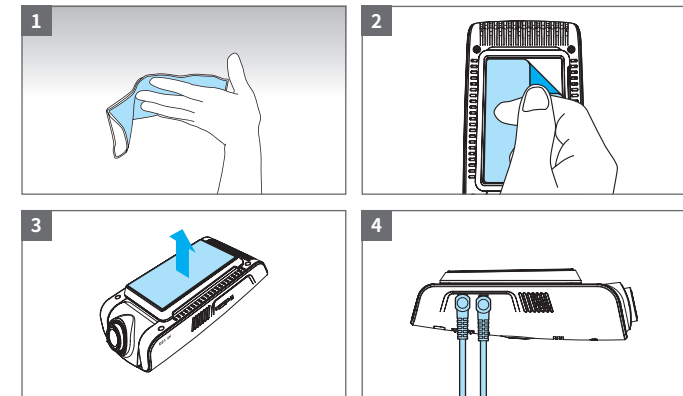

- (1) Clean the area where Dahscam will be installed.
- (2) Remove the protective film from the mount bracket.
- (3) Make sure the front camera lens is located in the center of the windshield. Press the mount to the installation location.
- (4) Connect power cable to DC-IN power port and rear camera.

⚠️ **Leave enough space and avoid overlapping wires to avoid interrupting reception with other devices such as navigation systems.**

2. Connecting Hardwiring Cable

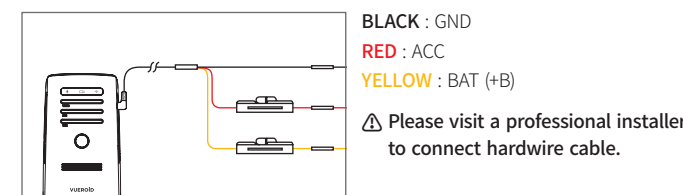

⚠️ **Please visit a professional installer to connect hardwire cable.**

3. Installing Rear camera

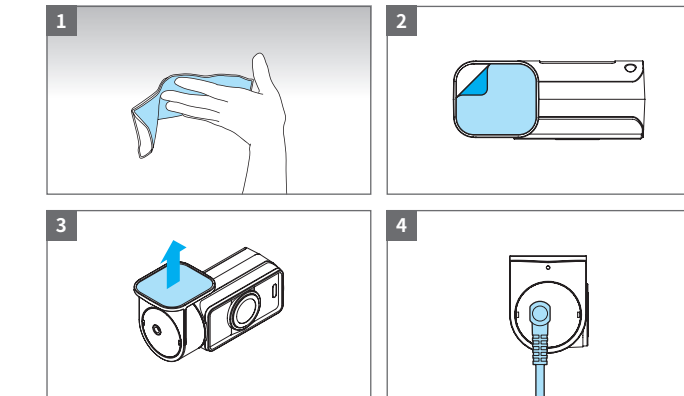

- (1) Clean the area where the rear camera will be installed.
- (2) Remove the protective film from the mount bracket.
- (3) Make sure the rear camera lens is located in the center of the windshield. Press the mount to the installation location.
- (4) Connect rear camera cable.

⚠️ **Before installation, make sure the vehicle engine is off.**
⚠️ **Make sure the installation location doesn't interfere with camera view.**

Using PC Viewer (Windows/Mac)

1. Software download and install

You can download VUEROID PC Viewer software from the VUEROID website (<https://vueroid.com/support/downloads>) and install it on your PC.

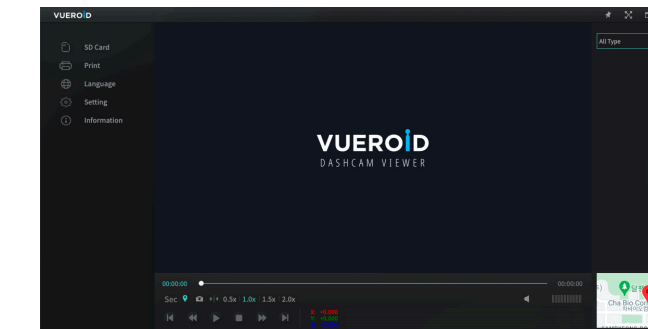

2. Start PC Viewer

- (1) Insert the MicroSD Card to your PC.
- (2) Open VUEROID PC Viewer.
- (3) Click 'Open Folder' and select the inserted MicroSD Card.
- (4) Video files in the MicroSD Card will be added in the file list of PC Viewer.
- (5) Select the video you want to play.

Product Specifications

Camera Sensor	Front: SONY STARVIS 2 (IMX678) Rear: SONY STARVIS (IMX307)
View Angle	Front: (D)165° x (H)125° x (V)62° Rear: (D)139° x (H)101° x (V)60°
Memory Card	MicroSD Card support 16GB/32GB/64GB/128GB/256GB
Wi-Fi	Built-in
GPS	Built-in
LED Indicators	Front: Security & Status LED Rear: Security LED
G-Sensor	3-Axis Acceleration Sensor, +2g / -2g
Speaker	Built-in
Microphone	Built-in
Video Codec	H.265 Main Profile
Recording mode	Driving/Event/Manual/Parking (Motion, Time lapse, Sleep & Wake Up)
Dimensions / Weight	Front: 114 x 65 x 37 mm / 93g Rear: 58 x 33 x 26.5 mm / 25g
Power Input	DC 12V-24V
Power Consumption	Max. 4.0W (12V)
Operating Temp.	-20°C ~ 70°C (-4°F ~ 158°F)
High Temp. Cut-off	Approximate 70°C (158°F) / Battery discharge prevention

Frequently Asked Questions

- Q1. Is it possible to use the product regardless of vehicle type?**
The product for both 12V and 24V can be used regardless of vehicle type.
- Q2. What is a low voltage prevention function (vehicle battery discharge)?**
The product is embedded with a low voltage prevention function. You can set voltage value in setting menu. If the voltage of a vehicle drops below the set value, the power of the product will be turned off automatically.
- Q3. No impact has occurred but a video file is saved in an event folder.**
The product detects impact through a G-sensor. An impact is saved in an event folder when the product detects shaking of a vehicle going over a speed bump or in other situations. It is possible to adjust the impact sensitivity in setting menu.
- Q4. No power or keeps rebooting**
 - 1) Check the power jack is properly plugged in
 - 2) Check the hardwiring cable is properly connected with the fuse and ground wire to the vehicle body
 - 3) Check the SD card
 - SD card properly inserted
 - Replace SD card
 - Format SD card

Warranty Information

- The followings not apply to the warranty.
- 1) Cosmetic damage such as scratches and dents.
 - 2) Damage caused by accident or natural disaster.
 - 3) Damage caused by service performed by anyone who is not an authorized service provider of VUEROID.
 - 4) Damage to a product by using power or accessories not supplied by VUEROID.

Firmware and Manual download is available in VUEROID website (<http://www.vueroid.com/support/downloads>)

Using smartphone application (Android/iOS)

- 1. App download and install**
Search "VUEROID Dashcam" in the Google Play Store or Apple Store then install it on your smartphone.
- 2. Connect your Dashcam to smartphone via Wi-Fi**
Turn on the Wi-Fi by pressing Wi-Fi button on the Dashcam. Then it shows a SSID (VUEROID_D21-4K_xxxxx) in the list of Wi-Fi network.

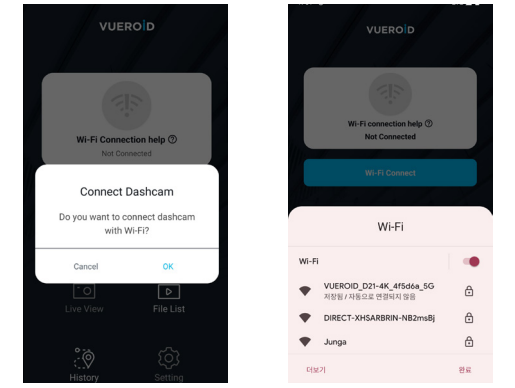

- Press "OK" once "Connect Dashcam" screen pop up.
- Select Wi-Fi network (VUEROID_D21-4K_xxxxx) in the Wi-Fi network list.
- Enter password. Default password is **12345678**.

3. Initial Setting

- Voice Pack: Select language of voice guidance
- Country: Select country
- GMT: Select standard time

4. Home screen

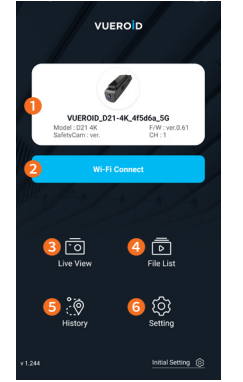

1 Wi-Fi Status	Displays Wi-Fi status and information of the connected Dashcam.
2 Connect Wi-Fi	Connect or disconnect Wi-Fi.
3 Live View	Front / Rear live view.
4 File List	View and play the recorded files.
5 History	View your driving history.
6 Setting	Menus for setting.

5. Live View Mode

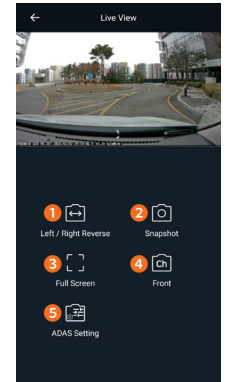

1 Left / Right Reverse	Reverse the image Left / Right.
2 Snapshot	Capture image from the video.
3 Full Screen	Display the full screen.
4 CH (Front / Rear)	Select front or rear live view.
5 ADAS Setting	Advanced Driver Assistance System (ADAS) settings.

6. ADAS Setting

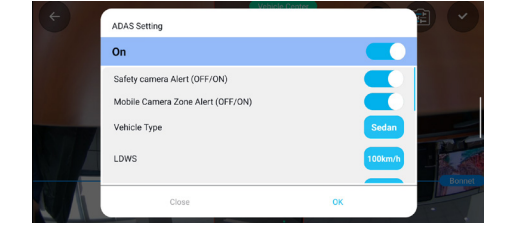

ADAS	On/Off (default On)
Vehicle Type	Sedan/SUV/Truck (default Sedan) Tab the bar to switch Sedan/SUV/Truck
LDWS (1)	On/Off (default On)
LDWS Sensitivity	50km/h, 60km/h, 80km/h, 100km/h (default 80km/h) Tab the bar to switch speed
FCWS (2)	On/Off (default On)
FCWS Sensitivity	Low/Middle/High (default Middle)
FVSA (3)	On/Off (default On)
RCWS (4)	On/Off (default On)
RCWS Sensitivity	Low/Middle/High (default Middle)
Front PCWS (5)	On/Off (default On)
Rear PCWS (6)	On/Off (default On)
Safety Camera (7)	On/Off (default On)
Mobile Camera Zone Alert	On/Off (default On)

- LDWS: Lane Departure Warning System
- FCWS: Front Collision Warning System
- FVSA: Front Vehicle Start Alarm
- RCWS: Rear Collision Warning System
- Front PCWS: Front Pedestrian Collision Warning System
- Rear PCWS: Rear Pedestrian Collision Warning System
- Safety Camera: Alert when vehicle approaches or passes the speed limit zone

7. File list

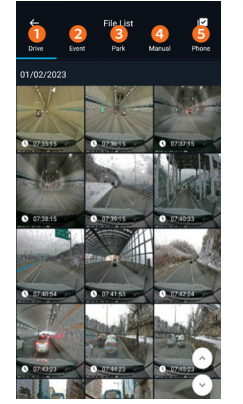

You can view and play the recorded videos through File list.

1 Drive	Driving recorded videos. Recorded videos are saved for 1minute segment with an auto-looping mechanism.
2 Event	Event-triggered videos. Video saved for 30 seconds, 10 seconds before an impact and 20 seconds after an impact.
3 Park	Parking recorded videos. Video saved for 30 seconds including motion/impact event.
4 Manual	Manual recording videos are saved for 30 seconds, 10 seconds before manual recording button is pushed and 20 seconds after.
5 Phone	Recording videos downloaded in your smart phone

8. History

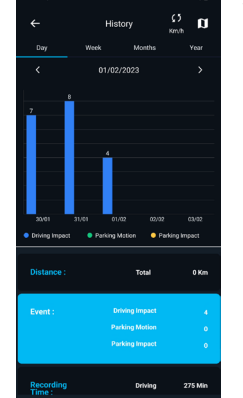

View your overall driving history such as trip distance, events, recording time, speed. You can check the data sorted by day, week, month and year base.

9. Travel log

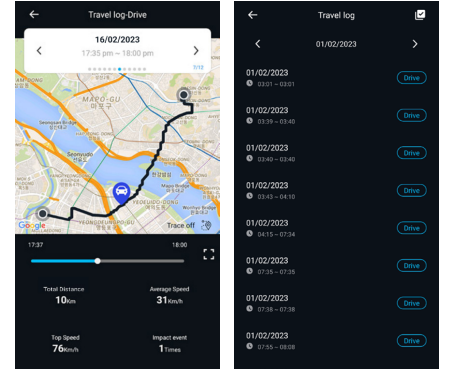

Travel-log-Drive shows vehicle's location on map, distance, speed, and event. You can check the data by date and time.

10. Edit video and share

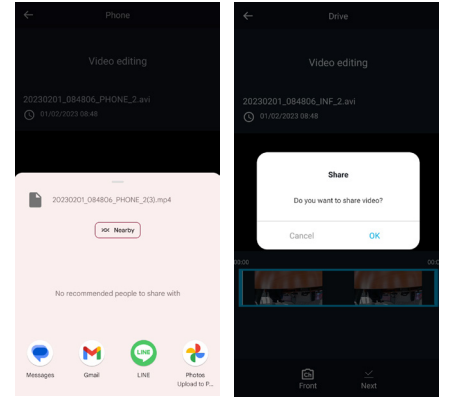

You can edit the recorded videos in the file list. To start the editing, video should download to your smartphone first. Edit the video then share it after disconnect VUEROID Wi-Fi and use mobile network.

11. Setting

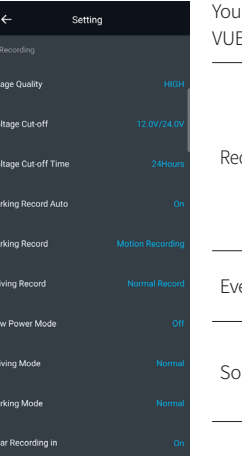

You can set the features as your preferences using VUEROID smartphone App or PC viewer.

Recording	Image Quality Voltage Cut-off Voltage and Time Parking Record, Driving Record Low Power Mode Driving, Parking Mode Rear Recording in Parking
Event	Driving and Parking Impact Front and Rear Motion
Sound	Voice Recording Speaker Volume Event Notification
Time	Standard Time Daylight Saving Time Time Setting
Memory	Memory Allocation for recording priority SD Card Format
System	Front, Rear Security LED Speed Unit, Mode Wi-Fi Auto-On, Wi-Fi Bandwidth, Wi-Fi AP Change Password Firmware Upgrade System Information Reset

