

**1A Assembled Drawer Unit. /
 Unité de tiroirs assemblée.**

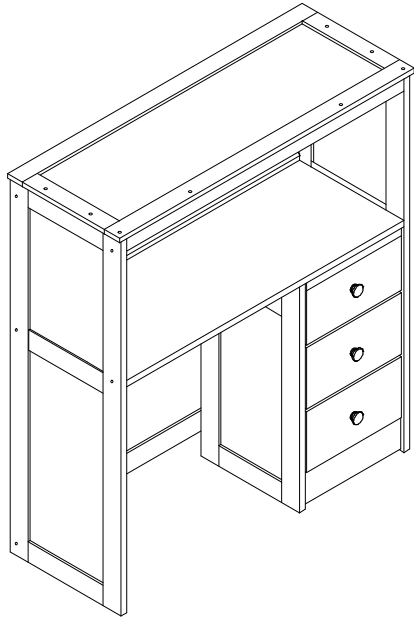

1C Parts in Box 5 / Pièces dans la boîte 5

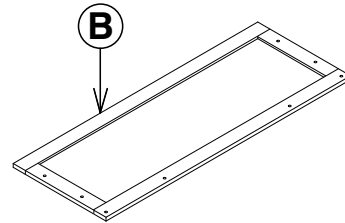

**(B) Top Panel /
 Panneau du haut x 1**

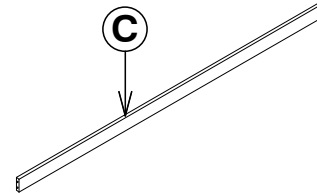

**(C) Upper Rails /
 Rails du haut x 2**

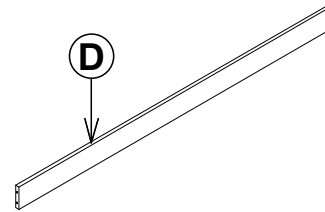

**(D) Lower Rail /
 Rail du bas x 1**

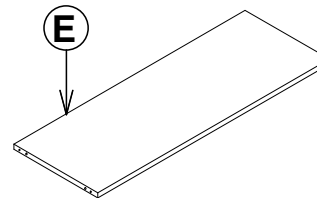

**(E) Shelf / Tablette
 x 1**

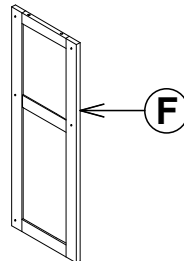

**(F) Side Panel (Left) /
 Panneau de côté
 (Gauche) x 1**

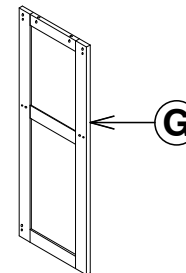

**(G) Side Panel (Right) /
 Panneau de côté
 (Droit) x 1**

**1B Parts in Box 4 /
 Pièces dans la boîte 4**

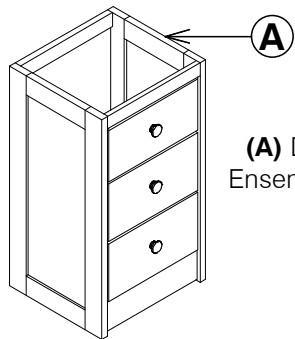

**(A) Drawer Set /
 Ensemble de tiroirs
 x 1**

**1D Hardware in this Box /
 Quincaillerie dans cette boîte**



**(1) Wood Dowels /
 Goujons de bois
 x 10**



**(2) 60mm Bolts /
 Vis (60mm)
 x 14**

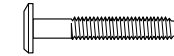

**(3) 40mm Bolts /
 Vis (40mm)
 x 2**



**(4) Barrel Nuts /
 Écrous
 x 14**

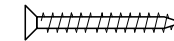

**(5) 38mm Wood
 Screws / Vis à bois
 (38mm) x 6**

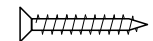

**(6) 32mm Wood
 Screws / Vis à bois
 (32mm) x 4**



**(7) Allen Key /
 Clef allen x 1**

*Tools required for assembly /
 Outils requis pour l'assemblage:*

- Allen Key (supplied) / Clef Allen (fournie)
- Phillips Screwdriver (not supplied) /
 Tournevis Phillips (non fourni)

**Step 1 /
 Étape 1**

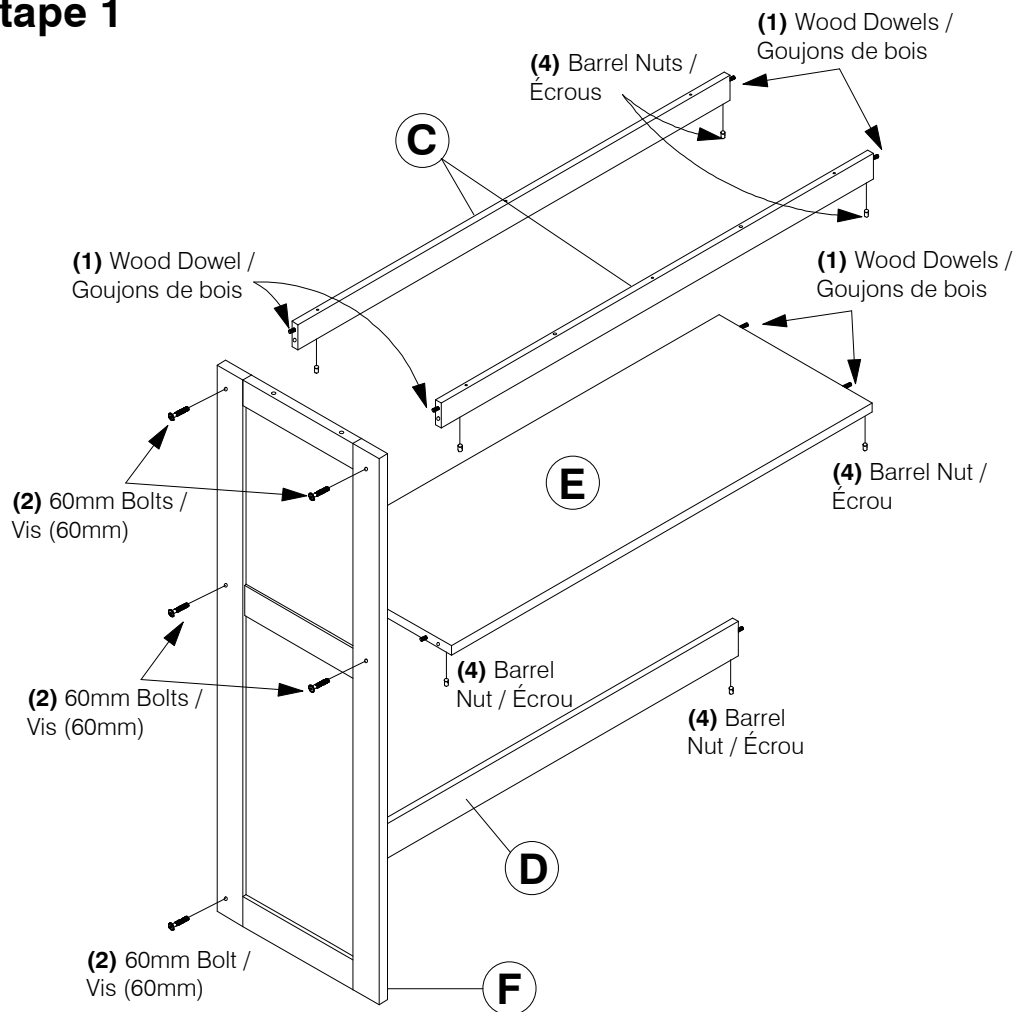

**Step 2 /
 Étape 2**

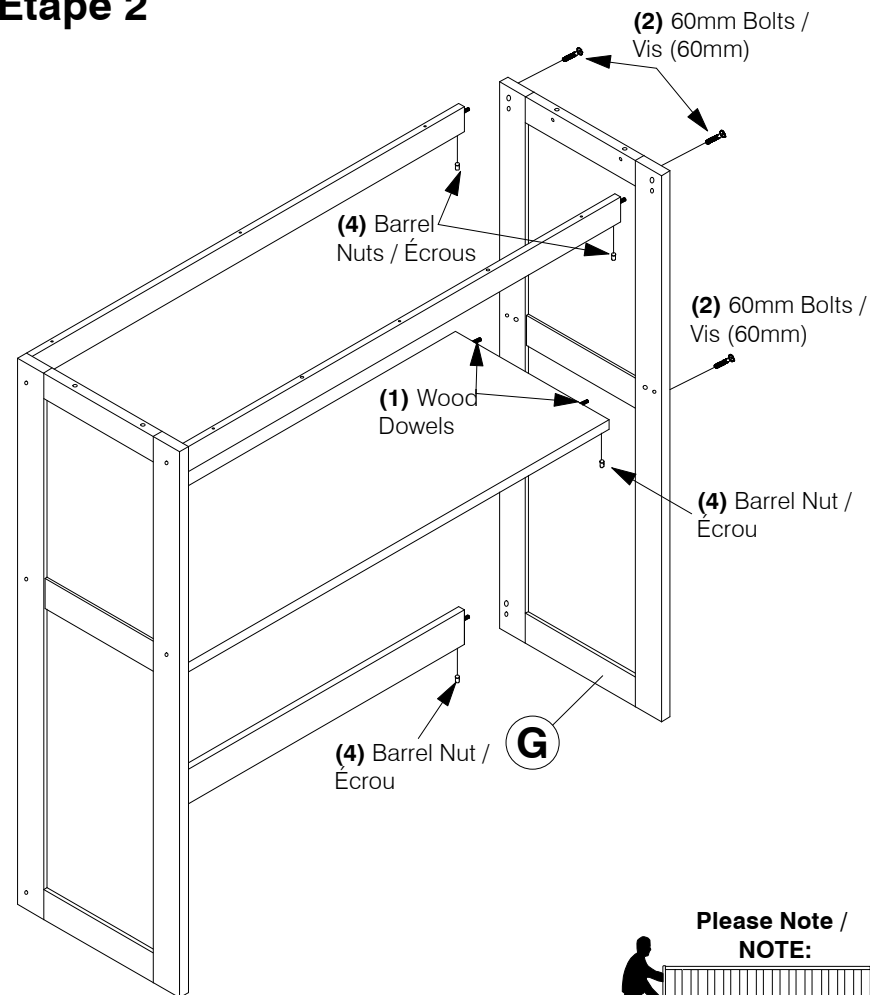

**Step 3 /
 Étape 3**

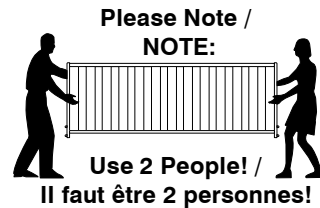
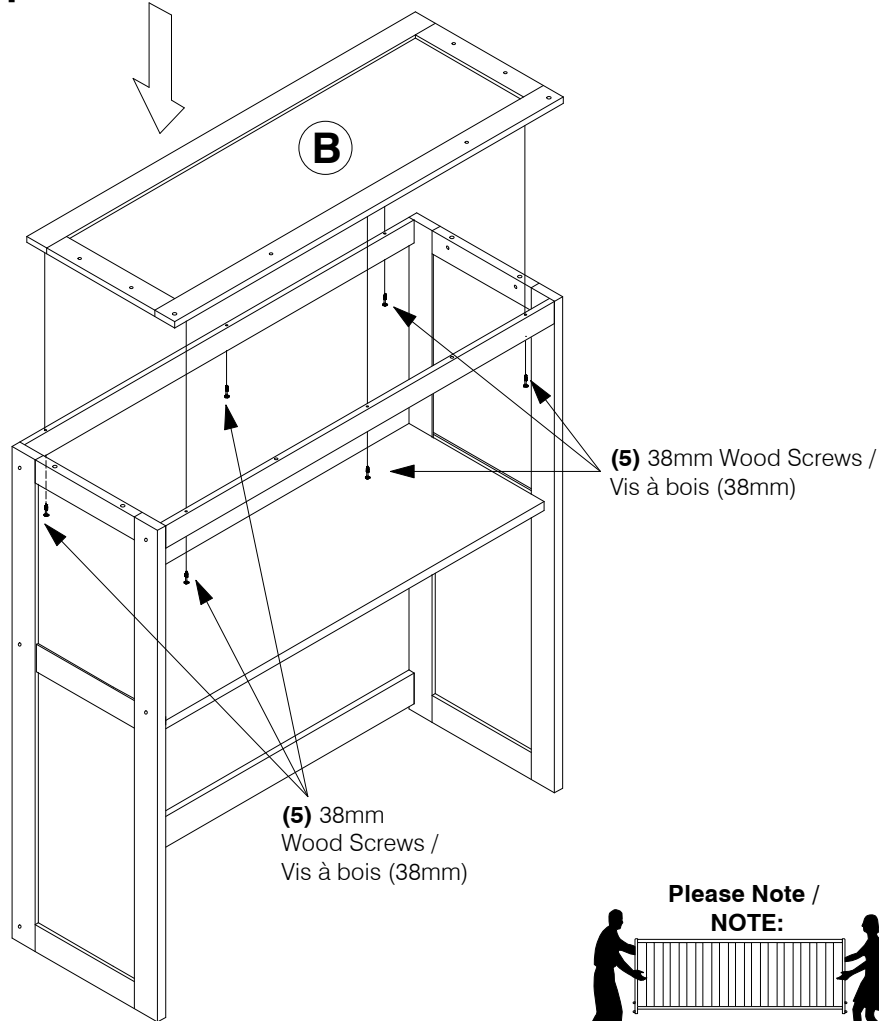

**Step 4 /
 Étape 4**

