



THE OUTDOOR
GREATROOM
COMPANY

Montego Fire Pit Table

Installation Instructions for Montego Fire Pit Models
MG-1242-BLSM-K and MG-1242-BLK-K



IMPORTANT

Please consult your Crystal Fire instruction manual for detailed instructions and important information related to hooking up your linear burner, including safety information, proper tightening of connections with two wrenches and full burner setup and lighting instructions.

DO NOT ATTEMPT TO INSTALL CF-1242 BURNER WITHOUT FIRST CONSULTING THE CRYSTAL FIRE OWNER'S MANUAL.

Contents

Required Tools.....	2
Included with your Fire Pit.....	3
Assembly Instructions.....	4
CF-SPARKER Installation	6
Gas Connections.....	7
Thermocouple Installation.....	8
Electrode Installation.....	8
Glass Installation.....	9
Position Your Tank.....	10

Required Tools



- **Utility Knife**
To cut and remove packaging



- **2 Open Ended Wrenches**
To secure gas connections



- **Leather Gloves**
To protect hands from glass and sharp edges during install



- **One AAA Battery (not included)**
Required for electric spark igniter installation



- **Two people are required for this installation**

Included with your Fire Pit



M6 Allen Wrench [X 1]



Bolt Caps [X 4]



Touch-up Paint [X 1]

Gas Valve Kit

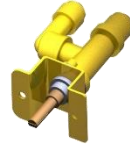

Gas Valve (x1)



Mounting screws (x2)

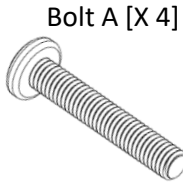

Bolt A [X 4]

M6X35



Bolt B [X 4]

M6X20



Bolt C [X 4]

M6X16



Control knob (x1)



Clear Silicone Pads [X 6]

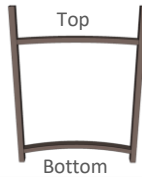

Center Support [X 1]



Panel A [X 1]



Panel B [X 1]



Panel C [X 1]



Access Door [X 1]



Glass Top



Glass Cover

Assembly Instructions

1. Unpack the fire pit table contents from the box, and remove individual packaging from each piece.
2. Lay Panel A on soft, flat surface.
3. Position Center Support on Panel A.

NOTE: it is very important to place the Center Support exactly as shown in the picture below. This will ensure that your burner (and propane tank, if applicable) will fit correctly with your fire pit table base. (Refer to “Included with Your Fire Pit” for component details).

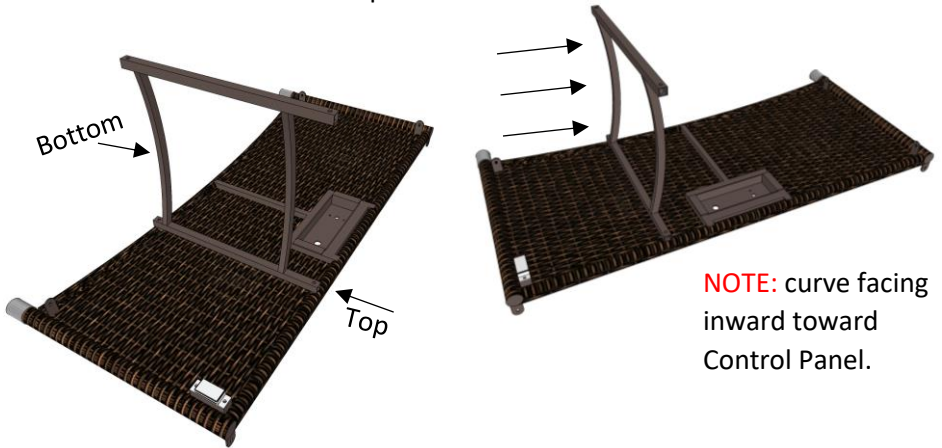

4. Attach Center Support with Bolt A (x2).

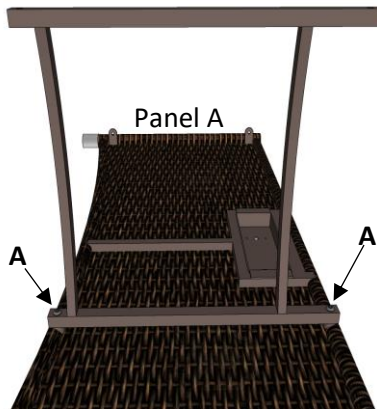

4. Stand up Panel A and use 2 more Bolt A to attach Center Support to Panel B.

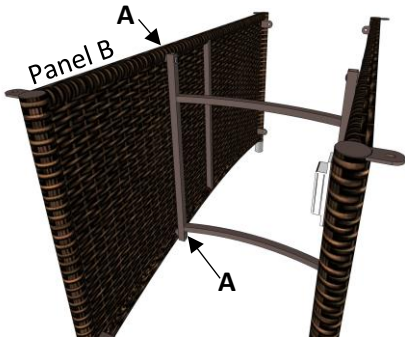

5. Use Bolt B (x4) to attach Panel C as shown.

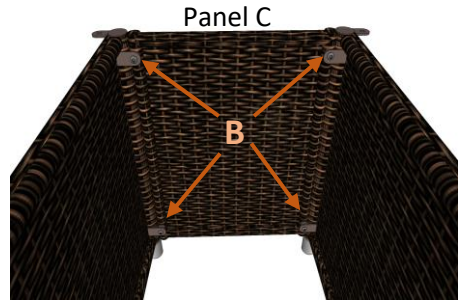

6. Remove the 4 pre-installed bolts (Bolt C) from the underside of the Glass Top, set the top into place on the base, and reinstall the bolts to fasten the top to the base.

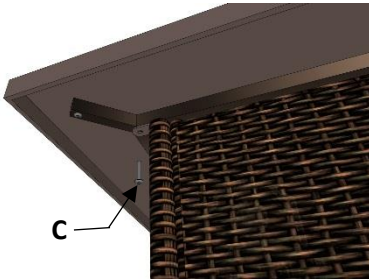

Optional: Attach Bolt Caps to Bolt C if you desire. Simply press on.

7. Once the Glass Top is in place, attach the Access Door to the fire pit table base. Set mounting pins at bottom of Access Door into the mounting holes located on side panels as shown below.

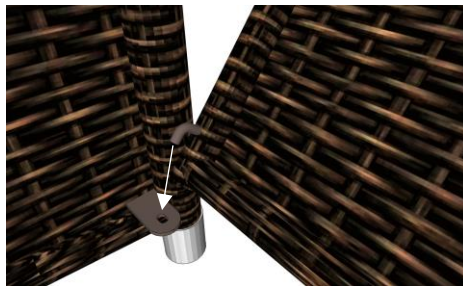

CF-SPARKER Installation

- Locate CF-SPARKER inside of Crystal Fire® Plus burner box.
- Remove CF-SPARKER cap and hex nut. Insert AAA battery (not included) with + end out.
- Install CF-SPARKER into control panel as shown below.
- Depress CF-SPARKER button to test your sparker.

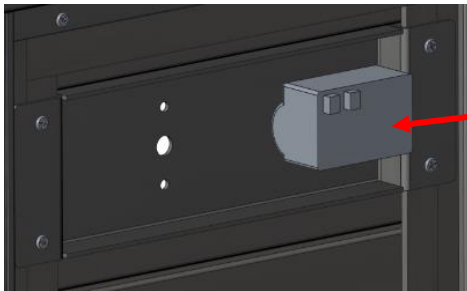
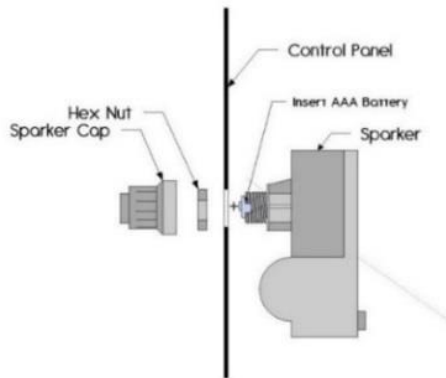

Locate and orient sparker box on control panel as shown. Sparker box must be installed **before** burner valve.

Gas Connections

**Read and understand your Crystal Fire® Plus owner's manual before beginning burner hookups or using the device.
Do not use Teflon tape or pipe dope on flare fittings.**

- **See Crystal Fire® Plus instructions for burner installation.**
 - All gas connections were completed at the factory.
- Check all connections for leaks. If needed, tighten connection with 2 wrenches and re-check for leaks.
- Attach burner valve to control panel with provided screws as shown below. Ensure sparker box is installed before this step.

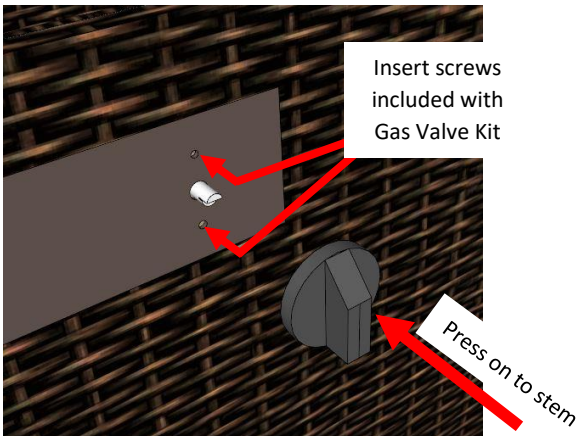
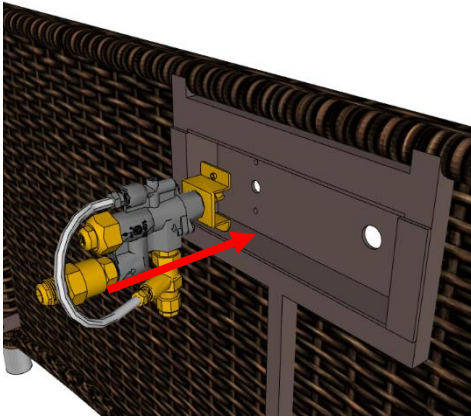

Thermocouple Installation

- Refer to Crystal Fire® Plus instruction manual for detailed attachment of thermocouple.
- Attach thermocouple to burner valve as shown below.

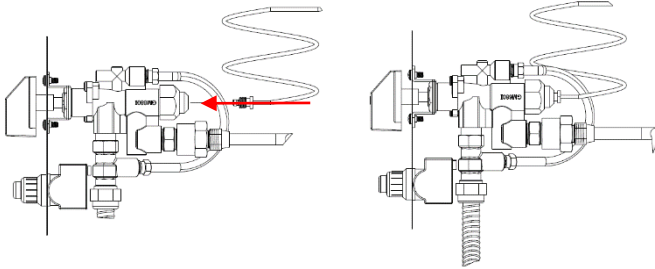

Electrode Installation

- Plug both **BLACK** wires hanging from the burner into the back of the CF-SPARKER. If an orange wire is present, do not use it. The orange wire is for Direct Spark Ignition system only.
- Test system by pushing the button on the igniter. Consult the troubleshooting section of the Crystal Fire® Plus Burner Owner's Manual, if the spark is weak, intermittent, or not present.

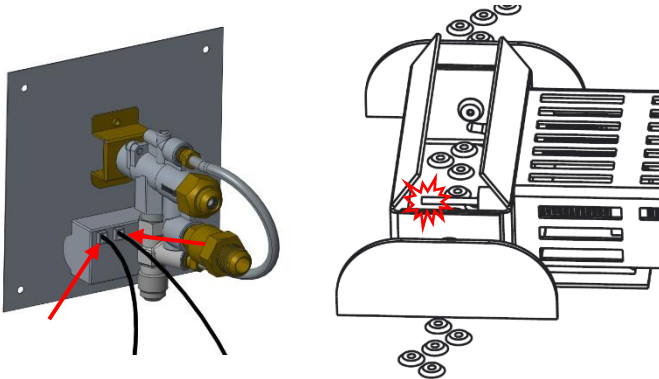

Glass Installation

1. Scatter all of the included Glass Beads evenly onto burner surface.

DO NOT OPERATE CRYSTAL FIRE® PLUS BURNER WITHOUT GLASS BEADS OR OTHER DECORATIVE MEDIA PRESENT

2. Place a single Silicone Pad in each corner and two in the center as shown below.

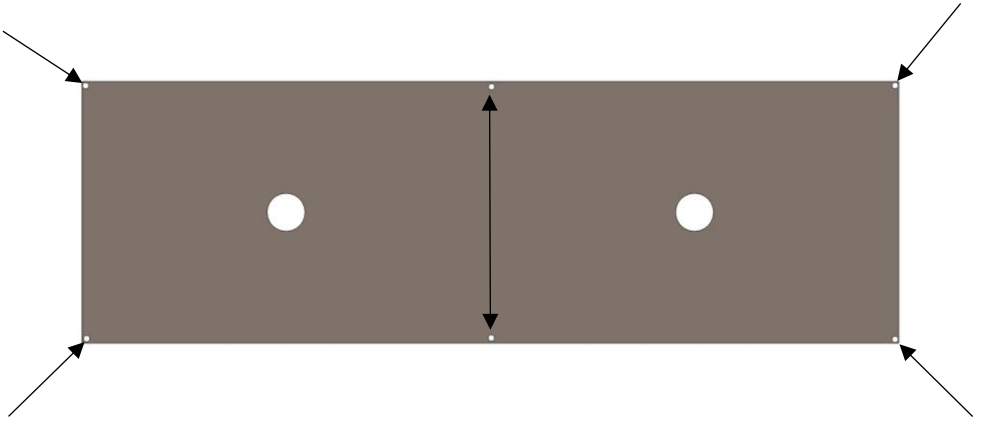

3. Set the cover into place on top of the burner with silicone pads facing down.

DO NOT OPERATE CRYSTAL FIRE® PLUS BURNER WITH GLASS COVER IN PLACE

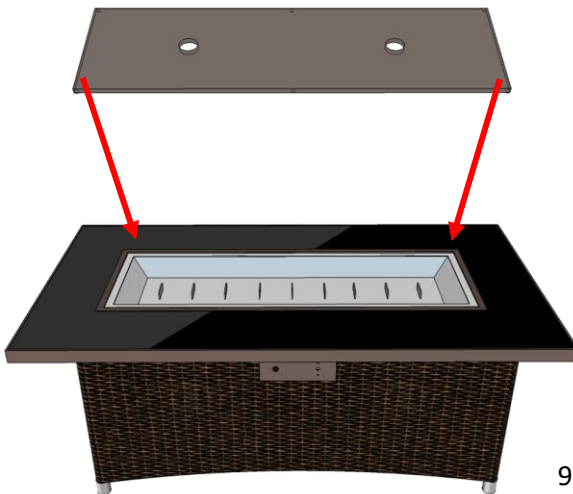

After installing igniter and making gas connections, verify that all connections are tight and that no leaks are present using a solution of soapy water or a commercially available leak-check solution.

Position Your Tank (if applicable)



1. Remove door, connect the propane hose/regulator to the propane tank and hand tighten (DO NOT USE A WRENCH) and slide the propane tank past the dotted line to ensure the door closes properly.
2. With the tank inside, ensure that no hoses, wires, or any other components are kinked or touching the burner pan.

IMPORTANT

Please consult your Crystal Fire® Plus instruction manual for detailed instructions and important information related to hooking up your linear burner, including safety information, proper tightening of connections with two wrenches and full burner setup and lighting instructions.

DO NOT ATTEMPT TO INSTALL CFP1242 BURNER WITHOUT FIRST CONSULTING THE CRYSTAL FIRE® PLUS OWNER'S MANUAL.

WARNING

After consulting the manual and following instructions, remember; before operating, all gas connections must be fully checked for leaks

Warranty: Fire pit tables are covered under a 1- year manufacturer's warranty. Please visit <https://www.outdoorrooms.com/product-registration> to register your product.



WARNING: This product can expose you to chemicals including Carbon Monoxide and Benzene which are known to the State of California to cause cancer or birth defects or reproductive harm. For more information, visit www.P65Warnings.ca.gov

14400 Southcross Drive West • Suite 100 • Burnsville, MN 55306
Toll Free: 1-866-303-4028 • Sales@OutdoorRooms.com