

# Operation Manual

## Genesis Model LT3140 Controller

***BARTLETT***

— **INSTRUMENT COMPANY** —

1032 Avenue H  
Fort Madison, IA 52627

319-372-8366

[www.bartinst.com](http://www.bartinst.com)

# Contents

Introduction .....	2
Precautions .....	2
Home Screen Overview.....	3
First Firing of the Kiln .....	4
Program the Controller .....	4
Review Program Before the Firing.....	4
Start The Firing.....	5
Review the Results .....	5
Menu Screen .....	6
Data Menu .....	6
Diagnostics .....	6
Adjustments .....	7
Configuration .....	8
Restore Presets .....	9
Factory Configuration .....	10
Ceramics Programming (Bisc or Glaze) .....	10
Glass Programming .....	12
Programming for Custom Firings .....	14
Calculating Ramp Rates for Custom Firing.....	16
Custom Ceramics Program.....	16
Start The Firing.....	17
Operation of the Controller During A Firing .....	17
Adjustments During a Firing .....	19
End of Firing – COMPLETE.....	20
Care of Thermocouple .....	20
Appendix A: Error Codes .....	21
Full Power Test.....	22
Appendix B: Cone Fire Temperature Profiles.....	23
Appendix C: Custom Firing Default Programs.....	24
Appendix D: Blank Firing Program .....	25
Appendix E: Common Questions and Situations .....	26
Appendix F: Zone Control .....	27
Appendix G: Connection Diagram.....	29

## Introduction

This manual covers the operation of the Genesis 3140 kiln controller. The Genesis is a versatile touch screen controller that regulates the temperature in your kiln so you can fire a variety of products like ceramics, glass, jewelry, and more. The Genesis has all the features of its earlier models, the V6CF and RTC1000, along with Wi-Fi capabilities for software updating, built in diagnostics, and maintenance logging among other new features.

## Precautions

- The controller is used to control temperature; it is not a safety device.
- Do not operate the controller in temperatures above 160° F.
- Always supervise your kiln during a firing.
- The controller contains electronic components which are sensitive to static electricity. Before handling the controller dissipate any static charge you may have by touching metal or a screw on the controller panel, the electrical box, the kiln lid, or some other grounded object.
- Always check the position of the thermocouple probe before starting a firing. The current temperature displayed on the controller is measured at the end of the thermocouple which must be in the firing chamber about 1" to 1-1/2". Seal the opening around the thermocouple with kaowool or similar material if necessary.
- Always review the current program before firing to ensure the correct profile is programmed.
- Ensure the kiln and the areas around the kiln are clear of combustible material. See kiln manufacturer's recommendation on required clearances.

# Home Screen Overview

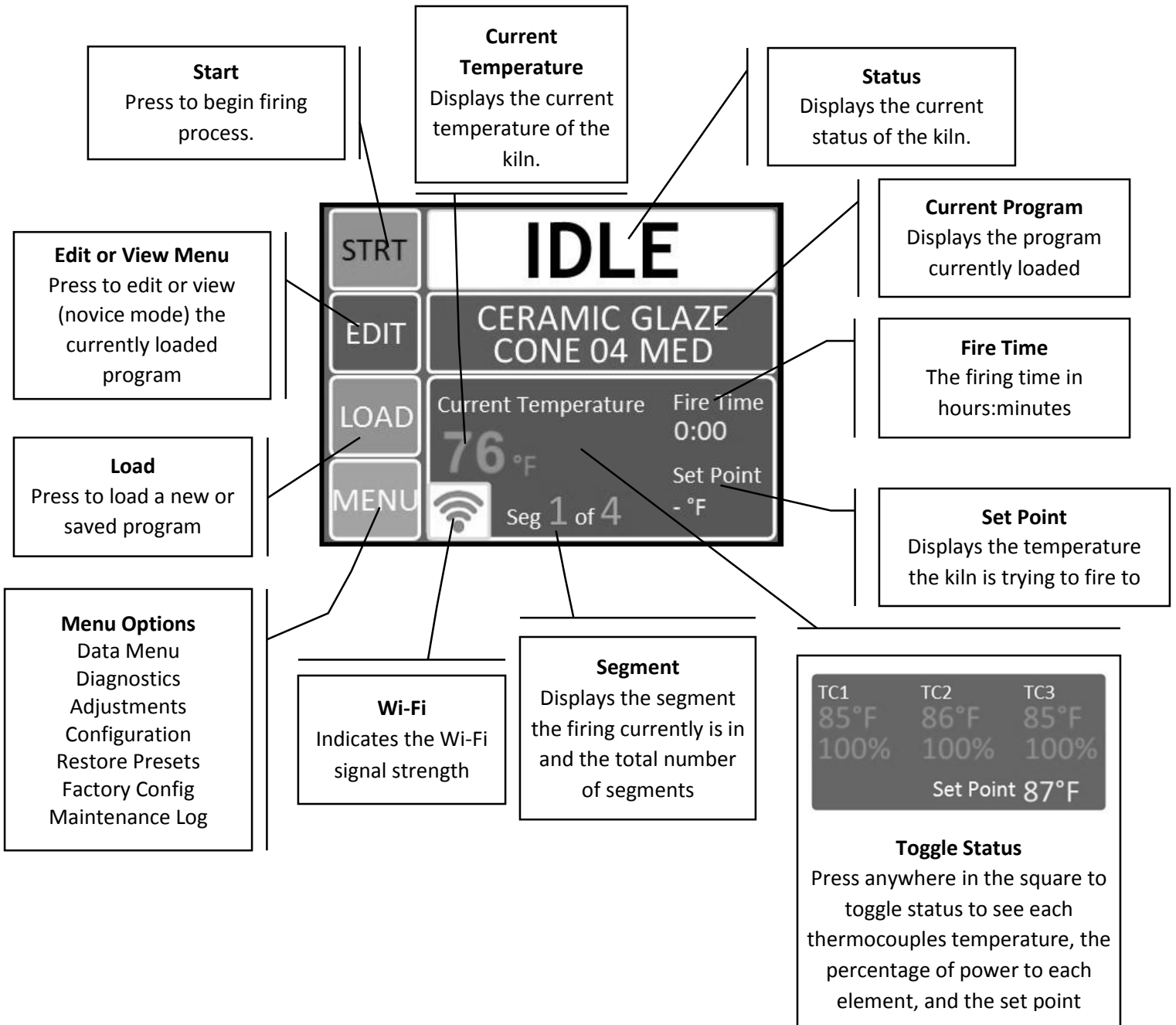

Figure 1: Home Screen Overview

## First Firing of the Kiln

The purpose of the first firing is to put a protective oxide layer on the elements and thermocouple. The first firing is done without ware in the kiln that might give off fumes that contaminate the elements. This first firing should have shelves and witness cones. The witness cones should be on the middle of the shelf nearest the center of the kiln. If your kiln is supplied with cones, the programmed cone number should match the cones provided, or you may use a cone of your own choice for the first firing. The example below is for a cone 04 firing, but if you use a cone other than 04, substitute that cone number in the programming. **Note:** The first firing should be done according to the kiln manufacturer's specifications if they are different from these instructions.

### Program the Controller

This example is for a Fast Glaze to cone 04 with no hold time at the end of the firing. The example below is for programming in Novice Mode (See page 8 for more info).

Step	Display Shows	Key Press	What This Selection Means
1	Home Screen	LOAD	You're ready to load the Ceramics program into the controller
2	What Are You Firing?	Ceramics	Choose from Ceramics, Glass, or Other. Choose Ceramics for the first firing of the kiln.
3	Cone Number 04 Temperature 1945	NEXT	Use the scroll bar on the right until Cone 04 is displayed.
4	What Speed?	Fast - Glaze thin pieces	The firing time for a Fast Glaze firing generally ranges between 4 to 5 hours.
5	Preheat time?	None - Thin, bone dry bisc or glaze	No preheat time is needed.
6	Program loaded: CERAMIC GLAZE CONE 04 FAST	OK	Returns to Home Screen at IDLE.

### Review Program Before the Firing

Press the View key to review the loaded program. Check that the settings are correct. If you'd like to change the alarm, go to Adjustments under Menu (See page 7 for instruction). When ready to fire, press BACK to return to the Home Screen.

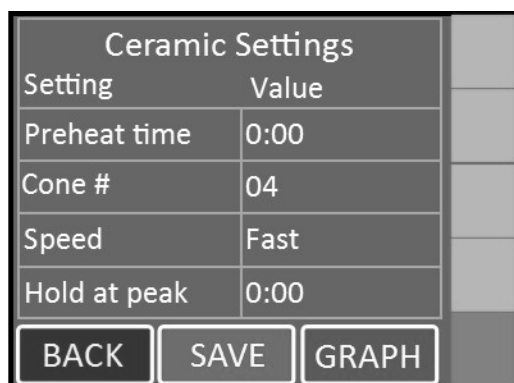

**Figure 2:** First firing program example. Use the green scroll bar on the right to see more options.

## Start The Firing

Step	Display Shows	Key Press	What This Selection Means
1	Home Screen	STRT	The kiln is ready to be fired.
2	Start Firing CERAMIC BISC CONE 04 FAST	1-Start Now	This kiln is ready to be fired and the start code must be entered.
3	Enter Start Code	1	The controllers default start code is 1. To change the Start Code, see page 9 for more details.
4	Enter Start Code	GO	Upon pushing GO, the firing will begin. You will hear clicking when the relays cycle power to the elements to regulate the temperature. This firing will take around 6 to 7 hours.
5	COMPLETE – CLR returns to idle.	CLR	The firing has gone to complete. The current temperature, fire time, segment, and set point is displayed.
6	Home Screen		Pressing clear returns the controller to IDLE . You may open the kiln when the temperature has cooled to 150°F.

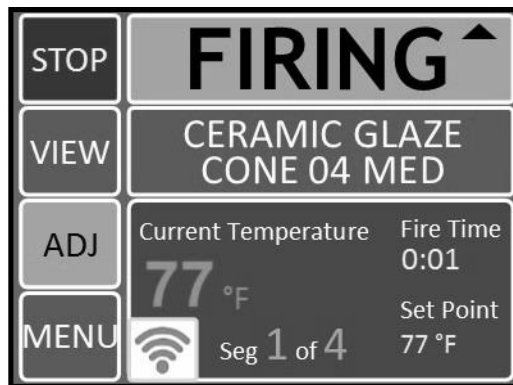

**Figure 3:** Sample firing screen. For more information about a firing in progress, see *Start The Firing* on page 17.

## Review the Results

A properly bent cone indicates that the kiln is functioning properly and accurately. The tip of the cone will be level with the top of the cone's base when fired properly. The diagram below will give you an idea of a properly fired, under fired, and over fired cone. Some variations from a proper bend is expected and can be compensated for with the cone offset adjustment for each particular cone number based on test firings.

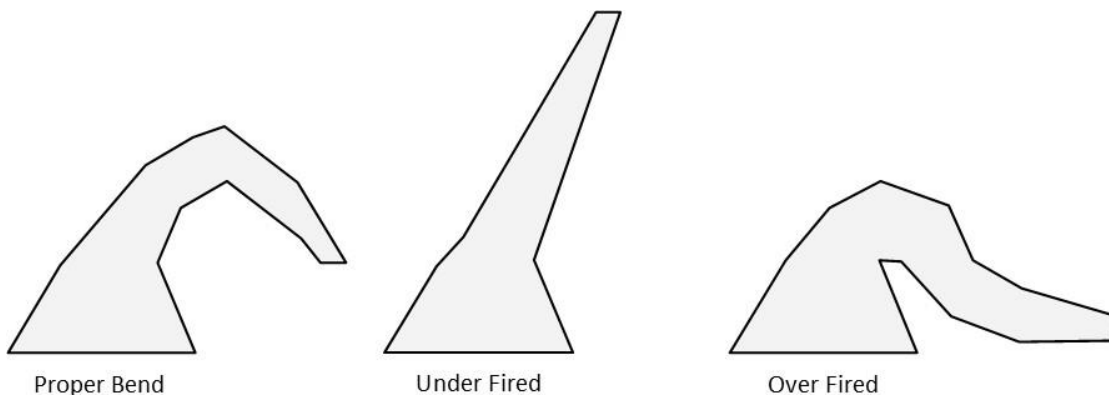

**Figure 4:** Samples of a properly fired, under fired, and over fired cone.

# Menu Screen

By pressing the Menu button on the Home Screen, you'll be taken to the Menu Screen. The Menu Screen is a list of various options from checking your last firing status, diagnostics, offsets, and controller configuration among other things. To navigate through the Menu options, press and hold the green slider on the right side of the screen and slide up or down for more options. For more information on each component of the Menu, see the descriptions below:

## **Data Menu**

The Data Menu holds 3 types of lists of information: diagnostic information, status information, and kiln information.

### **Last Firing Status**

Contains diagnostics information specific to the last firing of the kiln.

### **Last Error Status**

Contains diagnostic information specific to the last error that was encountered by the controller when firing.

### **Factory Diagnostics**

Contains diagnostic information from factory. This includes amperage readings for each section, line voltage readings, and board output. This information can be used for comparison when a manual diagnostic test is run.

### **Last Element Change**

Contains diagnostic information from the last new elements diagnostics. This includes amperage readings for each section, line voltage readings, and board output.

### **Last Manual Diagnostics**

Contains diagnostic information from the last manual diagnostics test. This includes amperage readings for each section, line voltage readings, and board output.

### **Kiln Info**

Contains the firmware version plus the serial numbers for registering and viewing your kiln at [www.bartinst.com](http://www.bartinst.com). Updating software will **NOT** affect the firing programs.

## **Diagnostics**

### **Board Temperature**

Displays the current board temperature. Displaying the board temperature is a diagnostics function to check the operation of the board. It's used to ensure a FAIL message is due to a bad thermocouple and not due to a faulty controller. If you get a "FAIL" message and the board temperature is approximately room temperature, then the thermocouple is faulty. The safe range for board temperature is between 0°F - 160°F. Any temperatures below or above that range may cause damage to the controller.

### Run Manual Diagnostics

This is used to manually begin a diagnostics test. It turns on each section of elements to read amperages and voltage. The results are stored under Data Menu – Last Manual Diagnostics.

### New Element Diagnostics

Run New Element Diagnostics when the elements have been changed to record amperages and voltages for the new element. The results are stored under Data Menu – Last Element Change

## Adjustments

Adjustments allows you to change the Cone and Thermocouple offsets as well as the Alarm temperature and Output 4 Percentage On for the controller.

### Cone Offset

Cone offset is used to raise or lower the final cone temperature. The final cone temperature can be raised or lowered a maximum of 99°F (37°C). To correct an under-firing set a positive cone offset. To correct an over-firing, set a negative (-) cone offset. To change the Cone Offset, press “**Cone Offset**”, enter the desired number and press “**Save**”.

Cone Offset example:

Degrees	Meaning	Effect
20°	Raise the final cone temperature by 20°F	Increases heat work
45°	Raise the final cone temperature by 45°F	Increases heat work
-15°	Lower the final cone temperature by -15°F	Decreases heat work
-35°	Lower the final cone temperature by -35°F	Decreases heat work

### Thermocouple Offset

Thermocouple offset is used to raise or lower the temperature indicated by the thermocouples. This is generally used to balance the heat-work in a zone controller kiln. The maximum TC Offset is 99°F (37°C). To correct an under-firing set a negative TC Offset. To correct an over-firing, set a positive TC Offset. To change the TC Offset for thermocouple 1, press “**TC Offsets**”, press “**TC1 Offset**”, enter the desired number and press “**Save**”. Repeat for TC2 Offset and TC3 Offset if needed.

### Alarm Temperature

Set the alarm temperature for the kiln. To set the alarm before the firing, press “**Set Alarm**”, type the desired alarm temperature, and press “**SAVE**”. The default alarm temperature is 9999°F (Off). The alarm setting will change as you change the loaded program. For example, the USER1 program is loaded and the user sets the alarm to 2400°F. The user then loads the USER2 program and sets the alarm to 1700°F. If the user loads USER1 again, the alarm temperature will change back to 2400°F automatically.

### Out 4 Percent On

Sets the “on time” Output 4 as a percent of output three’s “on time”. Only used when enabled by the kiln manufacturer.



## Configuration

### Novice Mode

The Genesis may come set in Novice Mode depending on the kiln manufacturer's preference. Novice Mode is meant for beginner users to make programming easier. For more advanced programming, Novice Mode can be turned off. To turn Novice Mode off, select "**Off**" and press "**Save**".

### Communications

Set up Wi-Fi for Firmware download and KISS ID for monitoring firings from your PC. (Additional computer software required)

**Kiss ID** – Each controller to be monitored must have a unique KISS ID number ranging from 1 to 50. See KISS manual for details.

**Wi-Fi Setup** – To set up Wi-Fi for the Genesis, press "**Wi-Fi Setup**" and the controller will scan for nearby networks. Select your desired network and enter the password (if required) and press "**Save**".

**Download Firmware** – If your controller is connected to the internet through the WiFi module, by pressing Download Firmware, you will connect to [www.bartinst.com](http://www.bartinst.com) to see if any updates are available. Once it has found the firmware, you have the option to update your controller.

### Temperature F/C

Choose which temperature scale to use with your kiln, Fahrenheit or Celsius. To change the temperature scale, press "**Temperature F/C**", press the desired temperature scale, either "**Fahrenheit**" or "**Celsius**", and press "**Save**".

### Error Codes

Turn the error codes on or off for the kiln. The default setting for the controller is On. We recommend you keep the error codes on to protect your firings. They can be turned Off, in special cases, such as jewelry or glass firings where the kiln is left open. They may also be turned off when troubleshooting kiln problems.

### Number of Zones

Change the number of zones (Thermocouples) the Genesis will control. Options are: 1, 2, or 3.

### Output 4 Options

Output 4 has 3 modes for running vent fans (Options A, B, & C), one mode that uses Output 4 to indicate the alarm has triggered (Alarm), and one mode for running elements in the lid or floor of the kiln (Percent).

Option A – Used to control a vent. Output 4 can be programmed to be on or off during each segment of a Custom program. During a Ceramic or Glass program, output 4 come on at the beginning of the firing and turns off after the kiln has cooled to 150°F.

Option B – Used to control a vent. Output 4 can be programmed to be on or off during each segment of a Custom program. Output 4 comes on at the beginning of a Ceramic or Glass program, off at 1450°F, back on after the firing is complete and the kiln has cooled to 1000°F and finally off again when the temperature is below 150°F.

Option C – Used to control a vent, an alarm, or other atmospheric control. Output 4 can be programmed to be on or off during each segment of a Custom program. Output 4 is off during Ceramic and Glass programs.

Alarm – When this option is selected, Output 4 comes on when the alarm is triggered.

Percent – Output 4 can be programmed to be on for a percent of the time Output 3 is on. This option is used when Output 4 controls floor or lid elements. To ensure Output 4 stays off at all times, use this option and set the percentage to zero.

### **Start Code**

The Start Code is entered to start a firing. Enter any 4 number combination and press “**Save**”. Default = 1. This will be entered anytime the kiln is fired.

### **Calibrate Touch**

Used to re-calibrate the touch screen if buttons aren’t working properly. Press the “**Calibrate Touch**” button and follow the onscreen instruction to re-calibrate.

## ***Restore Presets***

Restore all preset programs and offsets to factory settings.

### **Restore User Programs**

Restore individual User Programs 1-12 back to factory setting. Select the User Program to be restored and press “**RESTORE**”. This will clear any changes made to that user program from factory settings. Once you press “**RESTORE**” this cannot be undone. The restored default program will be loaded into the controller upon pressing “**RESTORE**”.

### **Reset TC Offsets**

Reset thermocouple offsets to factory settings. Default TC Offset = 0 for all thermocouples. To reset: Press “**2-Reset TC Offsets**” and press “**RESTORE**”.

### **Restore Cone Offsets**

Reset cone offsets to factory settings. Default Cone Offset = 0 for all cones. To reset: Press “**3-Reset Cone Offs**” and press “**RESTORE**”.

### **Restore Glass**

Restore the Glass firing setting back to factory. Once “**RESTORE**” is pressed, any changes made to the Glass profiles will be restored back to factory and cannot be undone.

## Factory Configuration

Factory configuration is used by the kiln manufacturer to set kiln specific parameters for the controller such as thermocouple type, top temperature, and board temperature. For more information, see the technical manual online. Contact the kiln manufacturer before making any changes that might damage the kiln

## Ceramics Programming (Bisc or Glaze)

Programming in Novice mode is the easiest method to program the controller to fire ceramics. Programming consists of choosing a cone number, firing speed, and a preheat time. The firing speed is chosen by the type of firing and thickness of the clay used. All 4 speeds below will calculate the firing rate at the end of a firing and adjust the final temperature for correct heat-work.

### Programming for Ceramics and Glazes in Novice Mode:

Step	Display Shows	Key Press	What This Selection Means
1	Home Screen	LOAD	You're ready to load a different program into the controller memory.
2	What are you firing?	Ceramics	Choose from Ceramics, Glass, and Other. Choose Ceramics for a bisc or glaze firing.
3	Cone Number XX Temperature XXXX	Next	Use the scroll bar to choose the desired cone number for the firing. Remember, cone numbers starting with a 0 are a lower temperature than cone numbers not starting with a 0. For example, don't mistake a cone 6 for a cone 06!
4	What speed?		Choose the firing speed either Fast, Medium, MedSlo, or Slow.
		Fast	Fast is the fastest firing speed and is used for glaze firings on thin ware, china paint firings, and decal firings. Firing times range from 4 to 5 hours.
		Or Medium	Medium is used for firing glaze on thicker ware or for bisque firing very thin ware. Typical firing time is 6-8 hours depending on the cone number.
		Or MedSlo	MedSlo is used to bisque medium pieces or thinner ware that requires less time for water smoking and carbon burn-out. Typical firing time is 9-11 hours, depending on cone number.
		Or Slow	Slow is used to bisc thicker, hand thrown ware. The slow speed gives extra time for release of water and carbon burn-out. Typical firing times range from 13-17 hours depending on the cone number. Hand built pieces may need a preheat stage.
5	Preheat Time?		Choose the preheat time, either None, 4 Hr, 8 Hr, or 12 Hr.
		None	No preheat time is needed when the pieces are a thin, bone dry bisc or glaze.

		Or 4 Hr	Use a 4 hour preheat time for thicker, slightly wet pieces.
		Or 8 Hr	Use an 8 hour preheat time for thick, wet pieces.
		Or 12 Hr	Use a 12 hour preheat time for hand built, kids pieces.
6	Program Loaded:	OK	Return to Home Screen at IDLE.

**Programming for Ceramics and Glazes with Novice Mode Off:**

Step	Display Shows	Key Press	What This Selection Means
1	Home Screen	LOAD	You're ready to load a different program into the controller memory.
2	Load Program		Choose between 1-Bisc, 2-Glaze, 3-Glass, or 4-Custom
		1-Bisc	The default bisc program will be loaded to the controller. Any saved changes made to the bisc program will overwrite the default program.
		Or 2-Glaze	The default glaze program will be loaded to the controller. Any saved changes made to the glaze program will overwrite the default program.
3	Program Loaded:	OK	Returns to Home Screen. To make changes to the loaded program, go into the edit menu.
4	Home Screen	EDIT	Displays the current settings for the firing. To change the settings, press the setting to be changed and select the new setting. For example: To change the preheat time, press Preheat Time, type in the new preheat time, and press Save.
5	Ceramics Settings Preheat Time Cone # Speed Hold at Peak Cooling	SAVE or Back	Returns to Home Screen at IDLE.

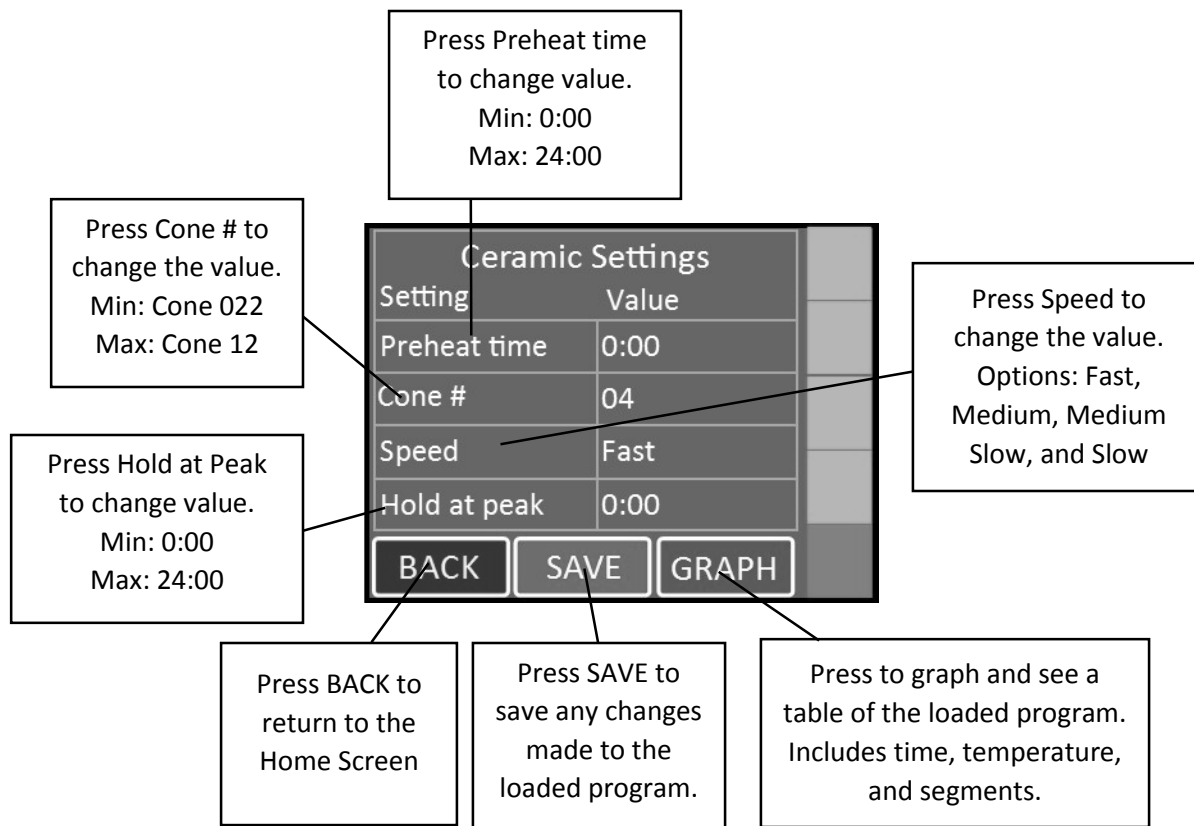

**Figure 5:** Ceramics programming sample.

**Note:** When a preheat is selected, the temperature ramps up at 60°F/hour (33°C/hr) to 200°F (93°C) for the amount of time programmed.

**Notes for Cooling (Not Pictured):** Scroll down to select Cooling. Cooling is set to Off unless changed by the user. With cooling turned on, it adds 2 segments on to the end of the firing. The first segment cools the kiln from the top temperature down to 1900°F at a rate of 9999 (As fast as possible). The 2<sup>nd</sup> and final segment cools the kiln from 1900°F down to 1500°F at a rate of 150°F per hour.

## Glass Programming

Programming in Novice mode is the easiest method to program the controller for glass firings. Programming consists of choosing the type of firing, firing speed, and COE (Coefficient of Expansion). The firing speed is chosen by the size of the glass being fired.

### Programming for a Glass Firing in Novice Mode:

Step	Display Shows	Key Press	What This Selection Means
1	Home Screen	LOAD	You're ready to load a different program into the controller memory.
2	What are you firing?	Glass	Choose from Ceramics, Glass, and Other. Choose Glass for slumping, fusing, or casting glass.
3	What type of firing?		Choose the type of firing, either Slump, Tac Fuse, Full Fuse, or Cast.

		Slump	Slump is used for firing glass pieces that you want to conform to a mold.
		Tac Fuse	Tac Fuse is used for fusing glass that result in softened edges
		Full Fuse	Full Fuse is used for fusing glass that result in soft, round edges
		Cast	Cast is used for melting glass pieces together.
4	What speed?		Choose the firing speed, either Fast, Medium, MediumSlow, or Slow.
		Fast	Fast is the fastest firing speed and is used for glass pieces that are either under 2in. x 2in. or very thin
		Medium	Medium is used for glass pieces that are under 4in. x 4in. or very thick.
		Med/Slo	Med/Slow is used for glass pieces that are under 8in. x 8 in. or 2 to 3 layers thick.
		Slow	Slow is the slowest firing speed and is used for glass pieces that are over 8in. x 8in. or multiple sheets thick.
5	Program Loaded:	OK	Return to Home Screen at IDLE.

**Programming for a Glass Firing with Novice Mode Off:**

Step	Display Shows	Key Press	What This Selection Means
1	Home Screen	LOAD	You're ready to load a different program into the controller memory.
2	Load Program	3-Glass	Choose between 1-Bisc, 2-Glaze, 3-Glass, or 4-Custom
3	Glass		Choose the type of glass firing, either Slump, Tac Fuse, Full Fuse, or Cast.
		Slump	Slump is used for firing glass pieces that you want to conform to a mold.
		Tac Fuse	Tac Fuse is used for fusing glass that result in softened edges
		Full Fuse	Full Fuse is used for fusing glass that result in soft, round edges
		Cast	Cast is used for melting glass pieces together.
4	Program Loaded:	OK	Returns to Home Screen. To make changes to the loaded program, go into the edit menu.
5	Home Screen	EDIT	Displays the current settings for the firing. To change the settings, press the setting to be changed and select the new setting. For example: To change the speed, press Speed, select the desired speed, and press Save.
6	Glass Settings Temperature Hold Time Speed Glass COE	SAVE or Back	Returns to Home Screen at IDLE.

## Programming for Custom Firings

The default custom programs are listed in Appendix C: Custom Firing Default Programs. The Genesis has 12 Custom user programs to store and reuse. The custom programs can have anywhere from 1 to 32 segments. Each segment has a firing rate, a soak temperature and a hold time. With Novice Mode on, you cannot make changes to the pre-loaded programs. With Novice Mode turned off, modifications can be made to the Custom programs.

### Programming a Custom Firing in Novice Mode:

Step	Display Shows	Key Press	What This Selection Means
1	Home Screen	LOAD	You're ready to load a different program into the controller memory.
2	What are you Firing?	3 - Other	Choose from Ceramics, Glass, and Other. Choose Other for custom firings
3	Other User1- User2- User3-	UserX -	Using the scroll bar on the right side of the screen, scroll until the desired program is displayed. For a complete list of the default programs, see Appendix C: Custom Firing Default Programs.
4	Program Loaded: CUSTOM UserX	OK	The selected custom program has been loaded.
5	Home Screen	VIEW	Use the scroll bar at the right side of the screen to view each segment in the loaded program. There is specific rate, temperature, and hold time for each segment. You cannot add, delete, or change segments when Novice Mode is activated.
6	UserX -	OK	Returns to Home Screen at IDLE.

### Programming A Custom Firing with Novice Mode Off:

Step	Display Shows	Key Press	What This Selection Means
1	Home Screen	LOAD	You're ready to load a different program into the controller memory.
2	Load Program	4-Custom	Choose between 1-Bisc, 2-Glaze, 3-Glass, or 4-Custom
3	Custom	UserX -	Using the scroll bar on the right side of the screen, scroll until the desired program is displayed. For a complete list of the default programs, see Appendix C: Custom Firing Default Programs.
4	Program Loaded: CUSTOM UserX	OK	The selected custom program has been loaded.

5	Home Screen	EDIT	To make changes to the loaded program, go into the edit menu. Use the scroll bar at the right side of the screen to view each segment in the loaded program. Displays the current settings for each segment of the firing (rate, temperature, and hold time for each segment). To change the settings, press the setting to be changed and select the new setting. For example: To change the rate for segment 1, press the temperature listed under Segment 1's rate, type in the new temperature, and press Save. Any saved changes made to the Custom user program will overwrite the default program.
6	UserX- #, Rate, Temp, Hold, F	SAVE or BACK	Returns to Home Screen at IDLE.

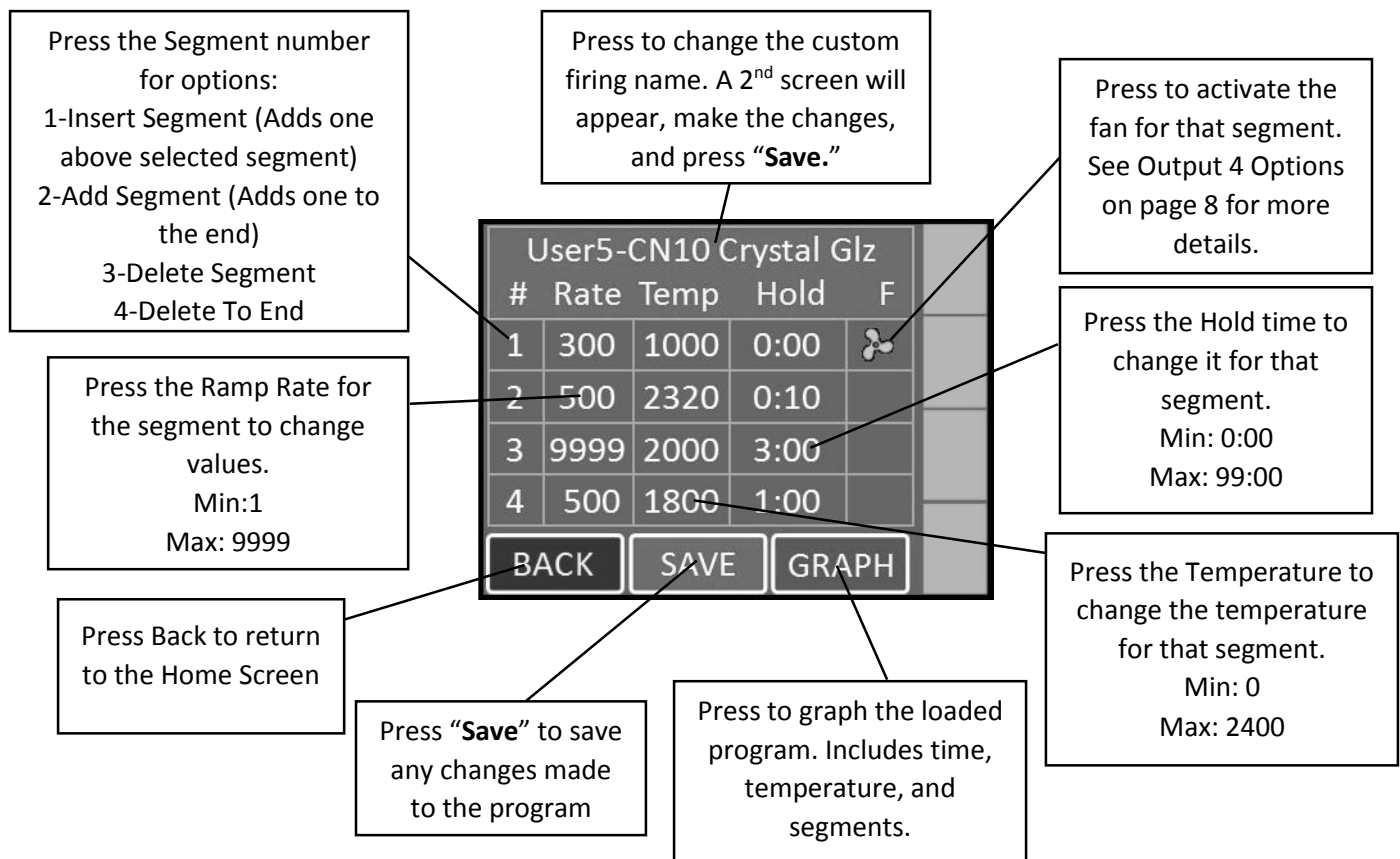

**Figure 6:** Sample of a Custom Program.



### Notes For Custom Programming:

1. The first ramp rate of any user program must be an increasing ramp which means the segment temperature must be greater than the starting kiln temperature.
2. To ramp up or down at the maximum rate, enter a rate of 9999.
3. To program a down ramp, enter the rate/hour then a temperature below the previous segment's temperature.
4. It is best to write out the firing profile that you plan to program before you begin programming. A blank form for writing your firing programs can be found in Appendix D: Blank Firing Program. Photo-copy as needed.

### Calculating Ramp Rates for Custom Firing

If you want to go from room temperature to 750°F in 3 hours, use this method to calculate the ramp rate. Take the temperature that you want to go to (750°F) minus the starting temperature (70°F – approximate room temperature) to get the number of degrees you want to increase in 3 hours (750 – 70 = 680). Divide this number by the time you want to get to 750 to give you the ramp rate (680°F ÷ 3 hrs = 227°F/hr). If you want to add another segment to go from 750°F to 1000°F in 4 hours, the same procedure is used. Take the end temperature minus the starting temperature (1000 – 750 = 250) and divide this number by the number of hours to reach 1000°F (250°F ÷ 4 hrs = 63°F/hr).

### Custom Ceramics Program

Writing your own ceramics program combines the versatility of the Custom program and the heat-work calculation of a ceramics firing. It is a great way to get custom heating and cooling rates and still have the controller do the heat-work calculation to get the correct cone bend regardless of firing rate. The steps to write your own cone fire are the same as entering a Custom program except when programming the top temperatures, press the “**CONE**” button, scroll until the desired cone number is displayed, and press “**SAVE**”. The selected cone's top temperature will be displayed under Temp for that segment. The cone temperature can be entered into any segment so you can also have cool down segments in the program.

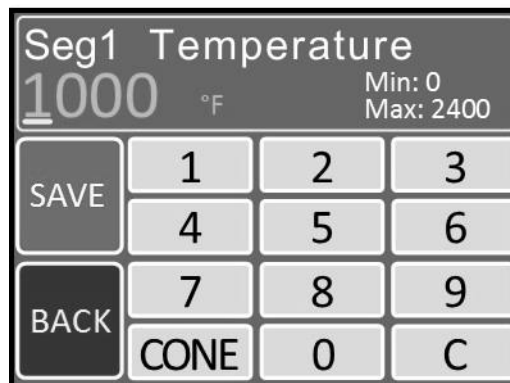

**Figure 7:** During a Custom Firing, you can enter the desired temperature or press CONE. Choose the desired Cone Number and the controller will enter the corresponding temperature.

## Start The Firing

Press “**STRT**” to open the Start Firing Screen. There are 3 options as to how you’d like to begin the firing. To start the kiln immediately, press “**1-Start Now**”, enter the start code (Default = 1), and press “**GO**”. To program the kiln to start in a set amount of time press “**2-Start Later**”, enter the start code, press “**GO**”, enter a delay start time of up to 4 hours, and press “**SAVE**”. **CAUTION: Make sure the kiln area will stay clear and safe throughout the delay time and firing time.** To arm the controller for a remote start via the KISS program, press “**3-Remote Start**”, enter the start code, and press “**GO**”. The controller will now read “**REMOTE**” at the top. This means the area around the kiln is clear, its loaded, and it can be fired at any time from the KISS program.

### Operation of the Controller During A Firing

The Genesis controller eliminates much of the “babysitting” that is required with a manual kiln. To ensure the most consistent results from one firing to the next, you should understand how the controller operates and monitor the firing to ensure proper operation. The following diagram and flow chart show the basic components of a kiln’s control system.

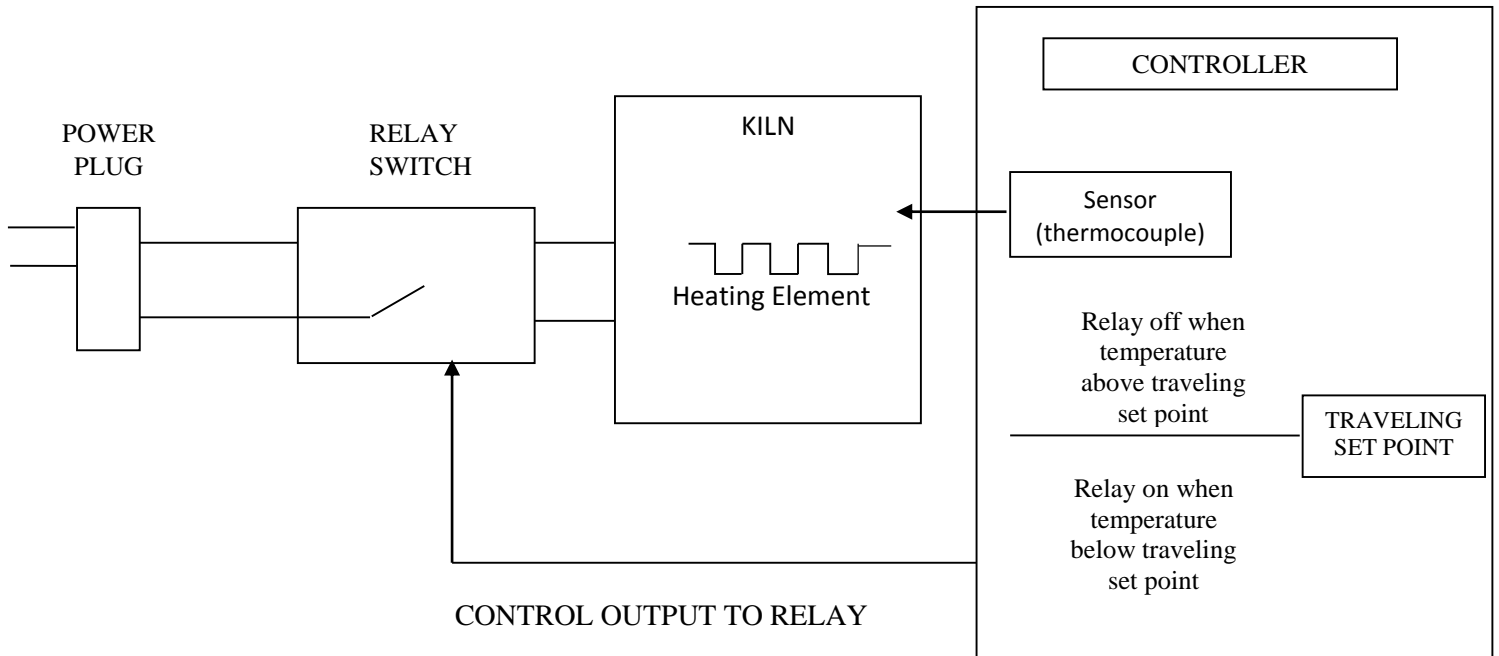

**Figure 8: Kiln Operation**

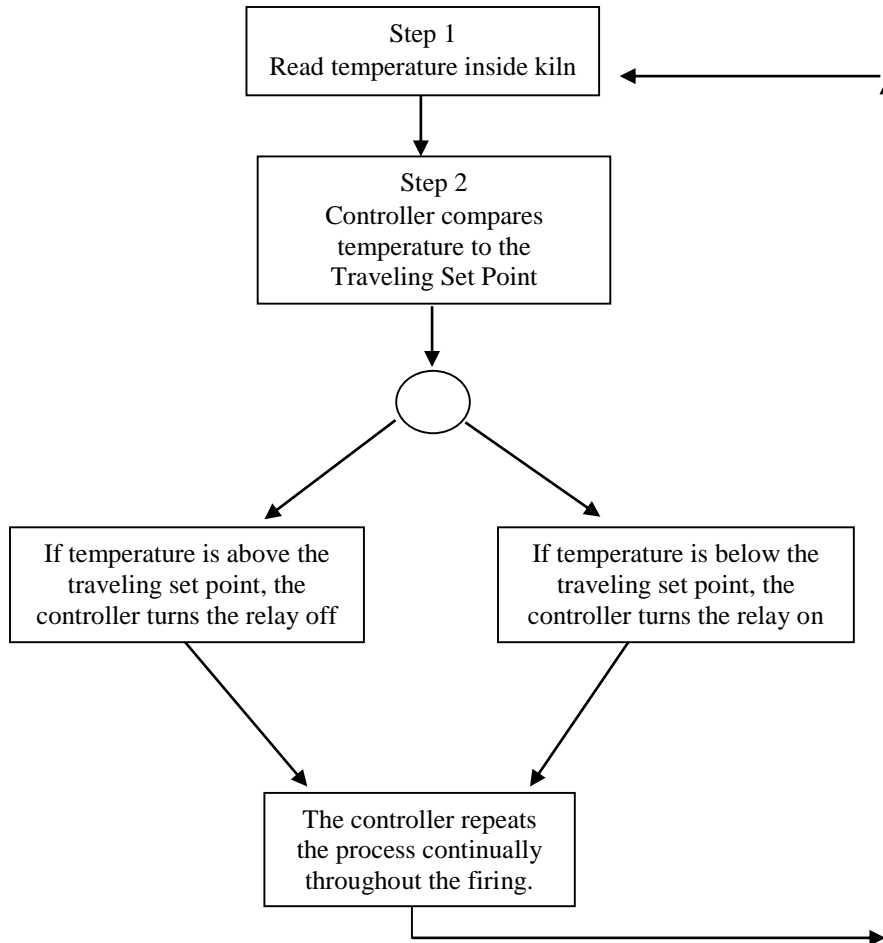

Figure 9: Controller Flow Chart

The diagram and flow chart show that the kiln control system, in its simplest form, works like your thermostat at home – when the temperature is too cool the heater comes on; when the temperature is too hot the heater turns off. The major components of the control system are the Genesis controller, thermocouple temperature sensor, relay switch, power source, and heating elements. The controller is the brain of the operation; the controller adjusts the traveling set point according to your program, reads the temperature in the kiln, cycles the relay on or off and determines when to end the program.

The thermocouple (T/C) sensor is the first part to inspect when loading the kiln. The tip of the T/C should protrude 1” to 2” into the firing chamber. Next, “START” is pressed, the controller reads the kiln temperature and uses that temperature as a starting point for a traveling set-point (also called the local set point). The displayed temperature is the temperature inside the kiln. You should then hear the relay(s) start cycling on and off to keep the temperature near the traveling set point. As the firing progresses the controller moves the traveling set-point according to the programmed firing rate. The displayed temperature should increase with the traveling set-point and the relay will be “on” longer. This sequence continues until the final temperature is reached and the controller turns off the kiln. The display reads “COMPLETE”.

## Adjustments During a Firing

Once a firing has been started, the screen will change to the Firing Screen, as seen on page 5. You can still view the program and make adjustments to the firing.

### STOP

Press STOP at any point in the firing to immediately stop the firing. The controller will return to the Home Screen. To start the program again, simply restart the kiln. The controller will start in the segment with an up-ramp equal to the kiln's current temperature. If the kiln does not restart in the segment it was stopped in, press the ADJ button and skip to the desired segment.

### View

View the setting for the firing. For a ceramic firing, the preheat time, cone #, speed, and hold time will be displayed. For a custom firing, each segment, temperature, hold time, and fan setting will be displayed. Press the "Graph" button, view the firing as a graph. This includes time, temperature, and segments. To see each individual segment, press the "TABLE" button. (Only applies to Ceramic or Glass firings) Changes or adjustments to the firing can't be made here once the firing has started. To make adjustments, press the ADJ button.

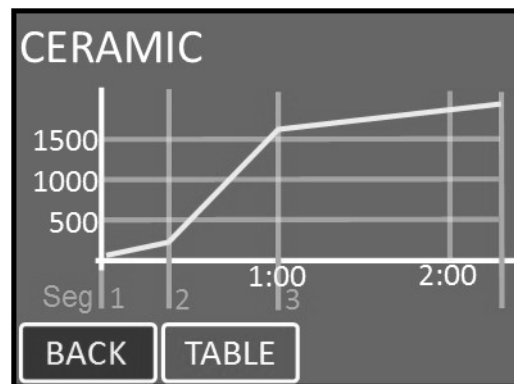

Figure 10: Sample graph of program during a firing.

### ADJ

Press ADJ to make adjustments to the firing while a firing is in progress. Pressing "Add Time" during a hold segment of the firing will add 5 minutes to the hold. It has no effect if the firing is not in a hold when pressed. Pressing "Add Temperature" during a hold segment will increase the hold temperature by 5°F. It has no effect if the firing is not in a hold when pressed. Pressing "Skip Step" will skip the current segment and move to the next in the firing. This feature is used when enough heat work has been done at the current segment and you want to immediately go to the next ramp rate. Pressing "Alarm Temp." allows you to adjust the alarm temperature for the firing. A temperature of 9999 shuts the alarm off.

### Menu

The firing menu allows for viewing of statistics and mid-firing diagnostics. By pressing Diagnostics, the controller runs a manual diagnostics test during the firing.

### ***End of Firing – COMPLETE***

When the firing is complete, an alarm will sound and the controller will display COMPLETE with the current temperature and firing time. To return to IDLE, press “CLR”. You may open the kiln when the temperature has cooled to 150°F.

### ***Care of Thermocouple***

The small metal rod protruding into the firing chamber is the temperature sensor, or thermocouple. Do not let shelves, posts, or ware touch the thermocouple; this could affect the temperature reading.

Bumping the thermocouple during loading can damage it or push it out of the firing chamber. It should protrude into the firing chamber about 1 -1/2”. Check the kiln manufacturer’s placement instructions. Also, avoid firing clay with high sulfur content. The sulfur erodes the thermocouple making it brittle and easy to break.

## Appendix A: Error Codes

If you get an error code, it is important to note the error letter or number. It will help our technicians in diagnosing any problem with the kiln. When an error code is displayed, it will give a short description of the error. Press “**CLR**” to clear an error code.

The list of error codes follows:

**NOTE: THESE ERRORS WILL ONLY BE DETECTED IF THE ERROR CODES ARE TURNED ON:**

Error Code	Description	Possible Causes
<b>ERROR 1</b>	Kiln temperature increasing slower than 12°F per hour when ramping up	This is a kiln heating problem, not a controller problem. Do the Full Power Test to check elements and relays. Low or dropping voltage to the kiln could also be the cause. A thermocouple reading incorrectly or improperly placed may also be the cause.
<b>ERROR 2</b>	Kiln temperature 50°F above hold temperature	A relay latched in the “on” position may cause this error. Another possible cause is if the kiln lid is opened for rapid cooling, then closed, such as for glass firings.
<b>ERROR 3</b>	Kiln temperature 50°F below hold temperature	Relay failure.
<b>ERROR 4</b>	Kiln temperature 50°F above previous hold when ramping down	Same causes as for <b>E-2</b> .
<b>ERROR 5</b>	Kiln temperature 50°F below traveling set point when ramping down.	Relay failure.
<b>ERROR D</b>	Kiln temperature 50°F above traveling set point	Stuck relay or stuck output. If using zone control, then the outputs or t/c’s may be in the wrong zones.

**NOTE: THE ERROR CODE SETTING DOES NOT AFFECT THESE ERRORS:**

Error Code	Description	Possible Causes and/or Corrections
<b>ERROR 0</b>	Software error	Check the selected program and reprogram, if necessary. If error persists or program does not hold in memory, controller may need to be returned to factory for service.
<b>ERROR 6</b>	Problem with thermocouple leads	This generally indicates the thermocouple is connected incorrectly, possibly reversed. Ensure the thermocouple extension wires are connected correctly to the controller and at all connection blocks back to the thermocouple.
<b>ERROR 8</b>	In cone fire mode, temperature decreasing in last segment	If the kiln has a kiln-sitter, it may have turned the kiln off before the controller did. Other possible causes are broken element or relay failure.
<b>ERROR 9</b>	Software thermocouple selection does not match the hardware thermocouple jumper selection	The jumper on the circuit board and the setting for thermocouple TYPE in the software do not match.
<b>E--</b>	Power loss during EEPROM write	Turn the controller off and back on. Recheck the selected program and reprogram, if necessary.

<b>ERROR A</b>	Invalid program variable	Reprogram all eight segments of the program being fired. If error persists, controller may need to be returned to factory for service.
<b>ERROR bd</b>	Board temperature too high	The control box temperature may be too hot or the limit temperature may need to be reset. If the room temperature is very hot, aiming a fan at the control box may decrease the temperature.
<b>ERROR E</b>	Hardware error	Controller will need to be returned to the factory for service.
<b>ERROR R</b>	Microprocessor memory does not match program storage memory (EEprom)	Reprogram and try to fire again. If error persists, controller may need to be returned to factory for service.
<b>ERRP</b>	ERRP will display. To clear the display, press "CLR". The firing in progress will continue.	Power outage; kiln is still firing.
<b>Thermocouple FAIL</b>	<b>Thermocouple FAIL</b> indicates one or more t/c's have failed. If more than one thermocouple is connected, the controller will indicate which thermocouple has failed.	Check the board temperature under Diagnostics under Menu. If the board temperature is approximately room temperature, then the t/c is defective. If the board temperature shows a high temperature the circuit board is defective.
<b>PF</b>	Power failure. Firing has stopped.	Power was lost during a firing and the kiln temperature was below 140°F or the kiln temperature dropped more than 250 degrees during the power outage.

### **Full Power Test**

The full power test is used to check the relays and elements of the kiln. To set the controller for a full power test, simply load the User12 program and turn the error codes to 9999. With the kiln empty and the lid open, start the firing. Visually inspect the elements after the kiln has fired for 20 – 25 minutes. Observe each element from where it comes into the kiln all the way around to see that it is equally bright throughout. The following observations are possible:

**One section of the kiln is dark and not coming on.** – This could indicate a defective relay since there is usually one relay per section.

**One element is not glowing at all.** – This indicates a broken or bad element.

**There are darker (Cool) spots along the elements.** – This indicates worn elements.

**The top and bottom elements appear brighter.** – This is normal for many kilns that have hotter elements in the top and bottom.

After you've made your observations, turn off the kiln. Contact your kiln manufacturer for kiln replacement parts (relays and elements). If there is an issue with your controller, please contact us.

## Appendix B: Cone Fire Temperature Profiles

Firing Profiles for Cone 04, Temperature 1945°F (1063°C)

<b>Ceramics – Slow (Bisc Hand Thrown)</b>			
Segment	Rate/hr	Temperature	Stage Time
1	80	250	2.25
2	200	1000	3.75
3	100	1100	1.00
4	180	1695	3.31
5	80	1945	3.13
<b>Total Firing Time:</b>		<b>13 hrs. 26 min.</b>	

<b>Ceramics – Medium (Glaze Larger Pieces or Bisc Thin)</b>			
Segment	Rate/hr	Temperature	Stage Time
1	150	250	1.20
2	400	1695	3.61
3	120	1945	2.08
<b>Total Firing Time:</b>		<b>6 hrs. 54 min.</b>	

<b>Ceramics – Med/Slow (Bisc Medium Pieces)</b>			
Segment	Rate/hr	Temperature	Stage Time
1	120	250	1.50
2	300	1000	2.50
3	150	1100	0.67
4	225	1695	2.64
5	108	1945	2.31
<b>Total Firing Time:</b>		<b>9 hrs. 38 min.</b>	

<b>Ceramics – Fast (Glaze Thin Pieces)</b>			
Segment	Rate/hr	Temperature	Stage Time
1	570	1695	2.85
2	200	1945	1.25
<b>Total Firing Time:</b>		<b>4 hrs. 6 min.</b>	

Firing Profiles for Cone 6, Temperature 2232°F (1222°C)

<b>Ceramics – Slow (Bisc Hand Thrown)</b>			
Segment	Rate/hr	Temperature	Stage Time
1	80	250	2.25
2	200	1000	3.75
3	100	1100	1.00
4	180	1982	4.90
5	80	2232	3.13
<b>Total Firing Time:</b>		<b>15 hrs. 2 min.</b>	

<b>Ceramics – Medium (Glaze Larger Pieces or Bisc Thin)</b>			
Segment	Rate/hr	Temperature	Stage Time
1	150	250	1.20
2	400	1982	4.33
3	120	2232	2.08
<b>Total Firing Time:</b>		<b>7 hrs. 37 min.</b>	

<b>Ceramics – Med/Slow (Bisc Medium Pieces)</b>			
Segment	Rate/hr	Temperature	Stage Time
1	120	250	1.50
2	300	1000	2.50
3	150	1100	0.67
4	225	1982	3.92
5	108	2232	2.31
<b>Total Firing Time:</b>		<b>10 hrs. 54 min.</b>	

<b>Ceramics – Fast (Glaze Thin Pieces)</b>			
Segment	Rate/hr	Temperature	Stage Time
1	570	1982	3.35
2	200	2232	1.25
<b>Total Firing Time:</b>		<b>4 hrs. 36 min.</b>	



## Appendix C: Custom Firing Default Programs

There are 12 preloaded custom firing profiles in the controller. If Novice mode is off, you can write over them to create your own programs. See Programming for Custom Firings to make changes to a preloaded program. For all programs, the alarm is set to off (9999). When the alarm temperature is changed, it only changes for the loaded program, not all programs.

User 1 – Blank 1			
Seg	Rate	Temperature	Hold
1	100	100	0:01

User 2 – Blank 2			
Seg	Rate	Temperature	Hold
1	200	200	0:02

User 3 – Blank 3			
Seg	Rate	Temperature	Hold
1	300	103	0:00

User 4 – CN6 Crystal Glz			
Seg	Rate	Temperature	Hold
1	300	1000	0:00
2	500	2230	0:15
3	9999	2000	0:00
4	500	1800	4:00

User 5 – CN10 Crystal GLz			
Seg	Rate	Temperature	Hold
1	300	1000	0:00
2	500	2320	0:10
3	9999	2000	3:00
4	500	1800	1:00

User 6 – Bead Annealing			
Seg	Rate	Temperature	Hold
1	9999	960	8:00
2	9999	960	0:45

User 7 – Wine Bottle			
Seg	Rate	Temperature	Hold
1	500	500	0:15
2	500	1000	0:15
3	600	1250	0:20
4	500	1475	0:15
5	9999	1100	0:30
6	200	970	0:30
7	120	750	0:10

User 8 – PMC FAST			
Seg	Rate	Temperature	Hold
1	9999	1650	0:10

User 9 – PMC3 FAST			
Seg	Rate	Temperature	Hold
1	9999	1290	0:10

User 10 – Lost Wax Silver			
Seg	Rate	Temperature	Hold
1	500	300	2:00
2	500	700	1:00
3	500	1350	4:00
4	9999	900	8:00

User 11 – Lost Wax Gold			
Seg	Rate	Temperature	Hold
1	500	300	2:00
2	500	700	1:00
3	500	1350	4:00
4	9999	800	8:00

User 12 – Full Power Test			
Seg	Rate	Temperature	Hold
1	9999	1000	0:40

## Appendix D: Blank Firing Program

Keep this page as a Master and photocopy as needed.

Firing Program Number: \_\_\_\_\_

Segment	Rate Per Hour	Temperature	Hold
1			
2			
3			
4			
5			
6			
7			
8			

Firing Program Number: \_\_\_\_\_

Segment	Rate Per Hour	Temperature	Hold
1			
2			
3			
4			
5			
6			
7			
8			

## Appendix E: Common Questions and Situations

### **Q. How do I clear an error message?**

**A.** To stop the sounding alarm, press anywhere on the screen. Then to clear the message, press “**CLR**” and the controller will return to the IDLE screen.

### **Q. What is a segment?**

**A.** A segment is the basic building block of a program. Each segment consists of a ramp rate in degrees per hour, a temperature you want to achieve, and whether you want to hold there or not. For example, a program for drying ware going at 60°F/hour to 200°F and holding for 2 hours would be a one segment firing, the ramp is 60, the temperature is 200, and the hold is 2.00.

### **Q. Do I need to use witness cones for each firing?**

**A.** After checking your kiln with witness cones for the first few firings, if you are satisfied with the results you are getting and how even the kiln is from top to bottom, then you do not need to use cones in each firing. It is a good practice to periodically place witness cones in the kiln to check for proper firing. If you suspect a problem or your results have changed, then it is a good idea to check the operation of the kiln with witness cones.

### **Q. Who do I contact for parts for my kiln?**

**A.** For replacement parts for your kiln (relays, elements, etc.), contact the kiln manufacturer. For any issues with your controller contact us at Bartlett Instrument Co. for a solution.

# Appendix F: Zone Control

Your kiln must have multiple thermocouples and be wired for multiple zones to take advantage of these features.

## 1. Features and Enhancements

- 3 separately controlled zones (3 T/C inputs, 3 outputs)
- Adjustable offsets for each thermocouple (T/C)
- Continues to fire with 1 or 2 failed thermocouples (T/C's)
- Slows ramping when any zone lags the set-point
- Reset function which zeros the TC offsets and turns the errors on

## 2. General Description

The Genesis advanced 3-zone control system is programmed the same as the single zone control but it ensures an even firing from the top to the bottom of the kiln. A 3-zone control has 3 temperature sensor inputs (thermocouples) and 3 independent outputs so the kiln can have 3 separately controlled sections (zones). The controller senses the temperature in each section of the kiln, compares the temperature to the desired temperature (traveling set-point) and adjusts the power going to each section separately giving each just the right amount of power to keep the temperature at the correct setting. The single zone controller only measures the temperature at the center of the kiln and gives all sections the same amount of power.

## 3. Automatic Lag Function

Lag refers to when the temperature of a kiln's section "lags" behind the traveling set point because the programmed ramp rate is faster than the kiln's temperature can rise. The Genesis will slow the ramp rate when a section of the kiln lags. The ramp rate determines the amount of "lagging" that is allowed before the firing rate is slowed. Fast ramp rates (>500 °F/hr) will allow the greatest temperature difference between sections. Slow ramp rates (<70 °F/hr) will have the smallest temperature differences between sections. Therefore, when the controller is programmed to go fast it will sacrifice evenness to obtain speed. Likewise, when the controller is programmed to go slow, the controller will maintain tighter control. The controller will try to balance speed and tight control when a medium speed is programmed.

## 4. Thermocouple Offsets

**(See T/C offsets and Cone offsets on page 7 for more information)**

Normal variation in thermocouples can cause a section to fire too hot or too cold. The zone control has an offset feature to adjust the reading of each thermocouple to compensate for any error. For example, if shelf cones indicate that the bottom section is under firing, it means that the controller thinks the bottom section actually reached the ending temperature when it really was below the ending temperature. To correct this problem, a negative thermocouple offset is required. This offset will be subtracted from the actual reading and will lower the temperature reading in that section. A negative offset will cause a section to fire to a higher temperature increasing the heat-work for that section. A positive offset will cause a section to fire to a lower temperature decreasing the heat-work for that section. To return all TC offsets to zero, press "**Menu**", scroll down and press "**5-Restore Presets**", press "**2-Reset TC Offsets**", and press "**RESTORE**".

## **5. Three Thermocouples**

Besides better measuring of the temperature, the zone control also offers security through its three thermocouples. With a single zone controller, a firing will be stopped if the thermocouple fails. The zone control with 3 T/C's will continue to fire if one or two of its thermocouples fail during a firing. If the top or bottom thermocouple fails, that section will be controlled by the top T/C. If the controller is at IDLE and a T/C fails, "Error Thermocouple Failed" will appear on the screen.

When using three thermocouples, thermocouple 2's temperature is displayed under current temperature. The temperature of each zone can be viewed during the firing. To view the other thermocouple temperatures, press the screen where the current temperature is displayed. The temperatures for all three T/Cs, percentage of power to the elements, and the current Set Point will appear.

# Appendix G: Connection Diagram

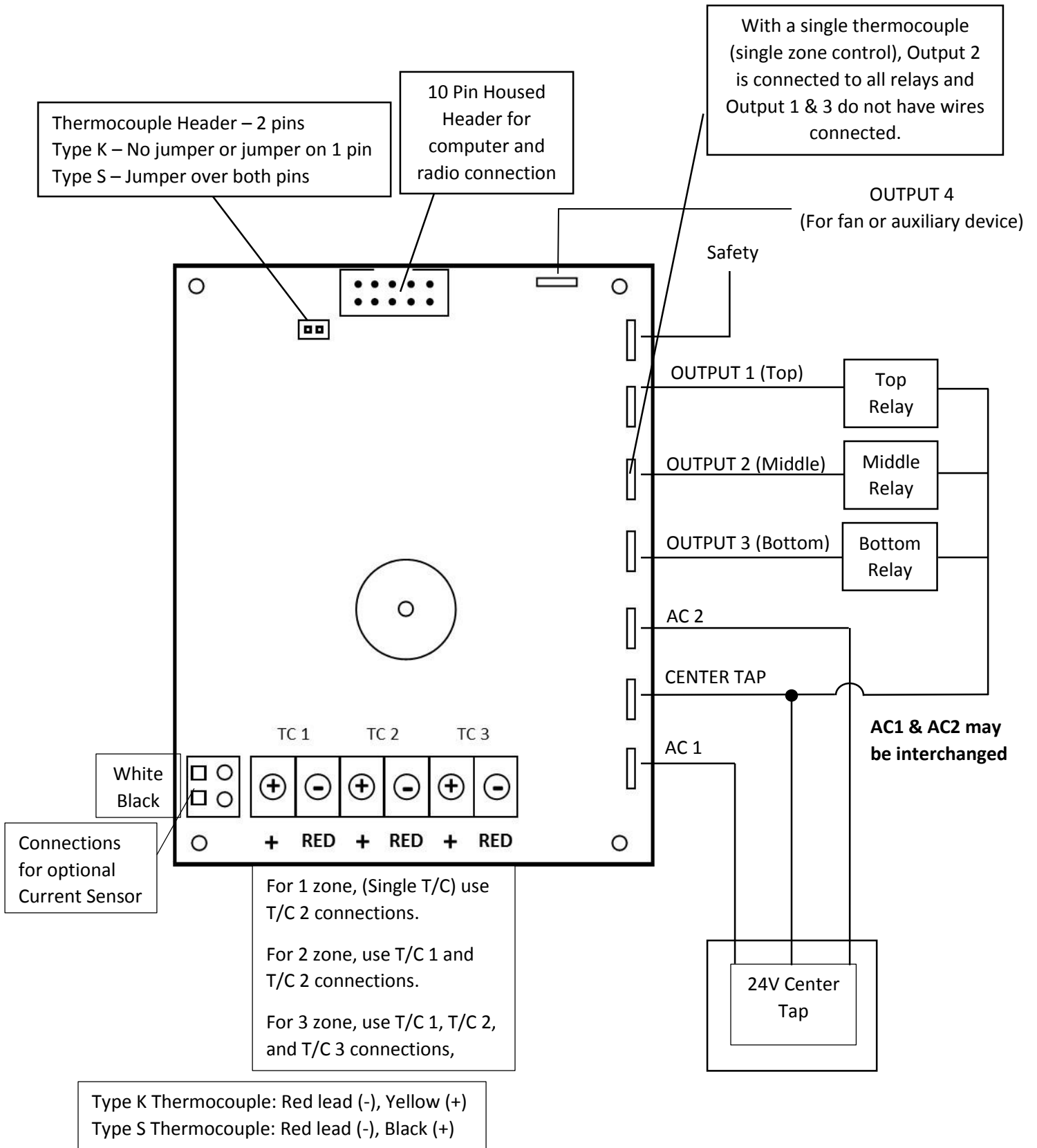

*Revised 3-3-16*