



ULTRAVIOLET LAMPS

Germicidal lamps
Double-tube germicidal lamps
Quartz germicidal lamps
Blacklight blue lamps(BLB)
Blacklight lamps(BL)
UV-B lamps

SANKYO
SANKYO DENKI CO.,LTD.

Germicidal lamps



Germicidal lamps efficiently emit a large amount of ultraviolet rays 253.7nm (nanometers) which have excellent germicidal effect. These lamps have structures and electrical characteristics similar to those of general fluorescent lamps used for illumination but use ultraviolet ray glass which efficiently transmits ultraviolet rays at 253.7nm.

A large selection is available with different sizes, shapes and ultraviolet ray output so that the most appropriate one can be selected according to the purpose.

The lamps are primarily useful for sterilization of air, the surfaces of various materials and water or liquid.

Type	Lamp Wattage (W)	Dimensions(mm)		Shape	Cap (B)	Lamp Current (A)	Ultraviolet Output (W)	Average Useful Life (h)	No. 60081 IEC
		Length (L)	Diameter (D)						
G4T5	4	134.5	15.5	Straight	G5	0.162	0.8	6,000	1020
G6T5	6	210.5	15.5	Straight	G5	0.147	1.7	6,000	1030
G8T5	8	287	15.5	Straight	G5	0.170	2.5	6,000	1040
G10T8	10	330	25.5	Straight	G13	0.230	2.7	8,000	—
G15T8	15	436	25.5	Straight	G13	0.300	4.9	8,000	2120
G20T10	20	580, 588.5	32.5	Straight	G13	0.360	7.5	8,000	2230
G25T8	25	436	25.5	Straight	G13	0.600	6.9	8,000	—
G30T8	30	893	25.5	Straight	G13	0.355	13.4	8,000	2320
G40T10	40	1,198	32.5	Straight	G13	0.420	19.8	8,000	2430
GTL2	2	55	20	Mini-Bowl	E17	0.220	0.12	2,000	—
GTL3	3	63	20	Mini-Bowl	E17	0.300	0.16	2,000	—

Ballasts and glow starters used for general fluorescent lamps can be used for germicidal lamps of this type. However, special ballasts are required for G25T8, GTL2 and GTL3.

- WARNING** The radiation of those lamps is harmful to eyes and skin.
Protect your eyes and your skin against the ultraviolet rays.

Dimensions and wiring diagrams

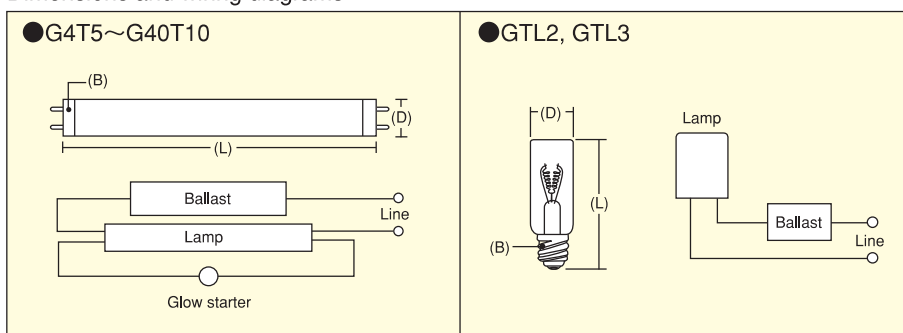

Germicidal lamps for air & water purification



Germicidal lamps efficiently emit a large amount of ultraviolet rays 253.7nm (nanometers) which have excellent germicidal effect.

A large selection is available with high output and long lamp life so that they can be used for disinfection of Air & Water purification.

Type	Lamp Wattage (W)	Dimensions(mm)		Cap (B)	Lamp Current (A)	Lamp Voltage (V)	Ultraviolet Output (W)	Average Useful Life (h)
		Length (L)	Diameter (D)					
G7T5	6.3	165	15.5	G5	0.230	30	1.3	6,000
G10T5L	16	357	15.5	Single pin	0.425	50	5.3	9,000
G10T5/4P	16	357	15.5	4 pin	0.425	50	5.3	9,000
G11T5	11	210,5	15.5	G5	0.330	37	2.2	8,000
G14T5	14	287	15.5	Single pin	0.400	40	3.0	8,000
G14T5/4P	14	287	15.5	4 pin	0.400	40	3.0	8,000
G16T5	16	287	15.5	G5	0.350	50	3.2	8,000
G20T5	20	400	15.5	G5	0.400	62	5.5	8,000
G22T5/436	22	436	15.5	Single pin	0.425	60	6.0	9,000
G22T5/436/4P	22	436	15.5	4 pin	0.425	60	6.0	9,000
G36T5L	39	842	15.5	Single pin	0.425	115	12.0	9,000
G36T5/G5	39	842	15.5	G5	0.425	115	12.0	9,000
G36T5/4P	39	842	15.5	4 pin	0.425	115	12.0	9,000
G55T8	55	893	25.5	G13	0.770	83	18.0	8,000
G64T5L	65	1,554	15.5	Single pin	0.425	250	25.0	9,000
G64T5/4P	65	1,554	15.5	4 pin	0.425	250	25.0	9,000

WARNING The radiation of those lamps is harmful to eyes and skin.
Protect your eyes and your skin against the ultraviolet rays.

Dimensions

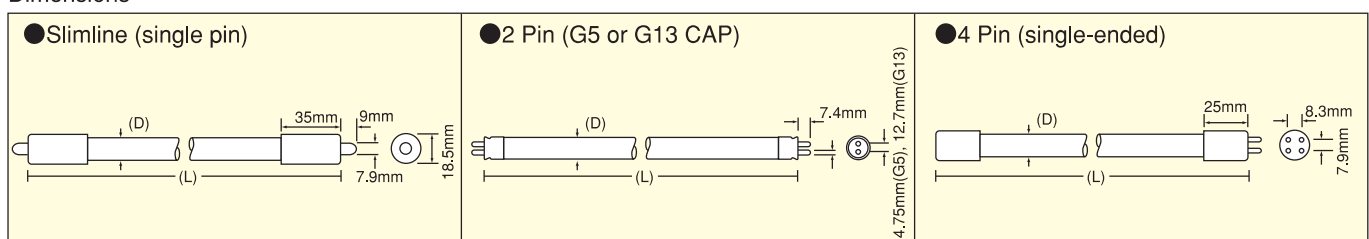

Compact germicidal lamps



Germicidal lamps efficiently emit a large amount of ultraviolet rays 253.7nm (nanometers) which have excellent germicidal effect. These lamps have structures and electrical characteristics similar to those of general fluorescent lamps used for illumination but use ultraviolet ray glass which efficiently transmits ultraviolet rays at 253.7nm.

A large selection is available with different sizes, shapes and ultraviolet ray output so that the most appropriate one can be selected according to the purpose.

The lamps are primarily useful for sterilization of air, the surfaces of various materials and water or liquid.

Type	Lamp Wattage (W)	Dimensions(mm)			Cap (B)	Lamp Current (A)	Lamp Voltage (V)	Ultraviolet Output (W)	Average Useful Life (h)	No.60901 IEC
		A Max.	B Max.	C Max.						
GPX5	5	28	13	85	G23	0.180	35	1.2	8,000	0005
GPX7	7	28	13	115	G23	0.180	45	1.9	8,000	0007
GPX9	9	28	13	145	G23	0.180	60	2.4	8,000	0009
GPX11	11	28	13	215	G23	0.155	90	3.0	8,000	0011
GPX13	13	28	13	170	GX23	0.285	59	3.6	8,000	0013
GPL5/K	5	28	13	85	2G7	0.180	35	1.2	8,000	2005
GPL7/K	7	28	13	115	2G7	0.175	47	1.9	8,000	2007
GPL9/K	9	28	13	145	2G7	0.170	60	2.4	8,000	2009
GPL11/K	11	28	13	215	2G7	0.155	91	3.0	8,000	2011
GPL18/K	18	40	20	225	2G11	0.375	58	5.5	8,000	2218
GPL24/K	24	40	20	320	2G11	0.345	87	8.5	8,000	2224
GPL36/K	36	40	20	415	2G11	0.435	87	12.0	8,000	2236
GPL55/K	55	40	20	533	2G11	0.540	106	17.0	8,000	—

WARNING The radiation of those lamps is harmful to eyes and skin.
Protect your eyes and your skin against the ultraviolet rays.

Dimensions

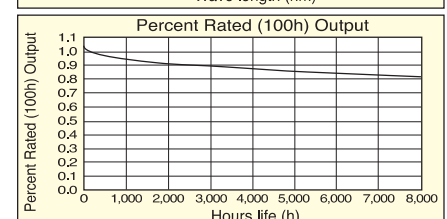
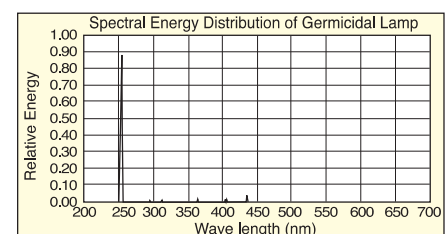
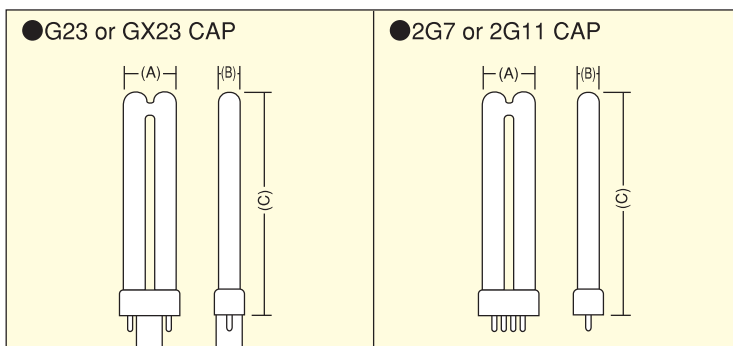

Double-tube germicidal lamps

●Ballast



●Lamp socket



These lamps are specially manufactured for double-tube germicidal lamps for use in water or liquid. They are very easy to handle because they have a double-tube structure with the outside of a straight germicidal lamp being sealed with quartz glass and a base is used in only one side. They are specifically designed for lighting in water, and have special sizes and electrical characteristics.

Therefore, the use of a special ballast and lamp holder is required. However, the ballast for GLD8MQ and GLD15MQ are the same as for general fluorescent lamps. For sterilization of water (liquid), select appropriate germicidal lamps taking into account the nature of water, depth, flow rate and volume, and type of germs.

Type	Lamp Wattage (W)	Dimensions(mm)			Base (B) (mm)		Lamp Current (A)	Ultraviolet Output (W) ^{*1}	Average Useful Life (h) ^{*2}
		Length (L1)	Diameter (L2)	Diameter (D2)	Diameter (D1)	Screw Thread			
GLK8MQ	8	189	29	21	40	M36 × 2	0.230	1.7	4,000
GLD8MQ	8	316	29	21	40	M36 × 2	0.170	2.4	3,000
GLD15MQ	15	339	29	21	40	M36 × 2	0.300	4.1	4,000

Use in water at 5 to 50°C. Do not use in air to avoid malfunction. Install a safety circuit or device (e.g., leak detector) if these lamps are used in a water tank or any other place where the human body may come into contact with them.

*1 Approximate 253.7nm output after 100 hours lighting.

*2 When the ultraviolet ray output becomes 60% of the initial output (after 100 hours lighting).

WARNING The radiation of those lamps is harmful to eyes and skin. Protect your eyes and your skin against the ultraviolet rays.

Dimensions and wiring diagrams

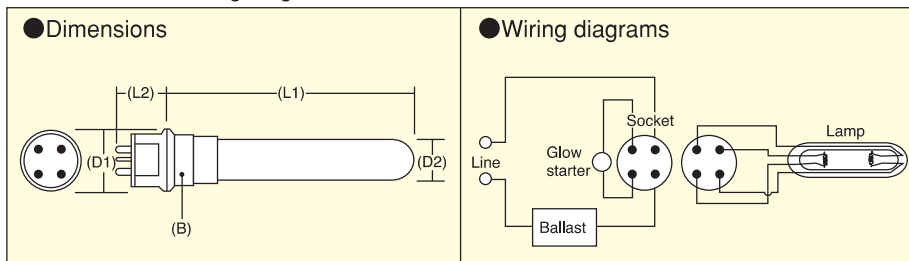

●Water sterilizer



Blacklight blue lamps (BLB)



These lamps efficiently emit near ultraviolet rays at 315nm-400nm which have strong photochemical and fluorescent effects.

They are special deep blue filter glass which absorbs visible rays and transmits near ultraviolet rays and two types of

phosphor are used with radiation peak at 352nm and 368nm, respectively.

They are used for tests, inspections, examinations, and investigations in various fields, as well as for stage illumination in theaters and nightclubs, advertisements and sign boards.

Type	Lamp	Dimensions (mm)		Shape	Cap(B)	Lamp Current	Wave Length	Ultra violet Output	Average Useful Life	No. 60081 IEC
	Wattage									
	W	Length	Diameter							
F4T5BLB	4	134.5	15.5	Straight	G5	0.162	352	0.4	3,000	1020
							368	0.5	3,000	1020
F6T5BLB	6	210.5	15.5	Straight	G5	0.147	352	0.8	3,000	1030
							368	0.9	3,000	1030
F8T5BLB	8	287	15.5	Straight	G5	0.17	352	1.3	3,000	1040
							368	1.4	3,000	1040
F10T8BLB	10	330	25.5	Straight	G13	0.23	352,368	1.5	4,000	-
F15T8BLB	15	436	25.5	Straight	G13	0.3	352,368	2.6	4,000	2120
F18T8BLB	18	588.5	25.5	Straight	G13	0.37	352,368	3.7	4,000	2220
F20T10BLB	20	588.5	32.5	Straight	G13	0.36	352,368	3.7	4,000	2230
F20T10BLB/RS	20	588.5	32.5	Straight	G13	0.36	352,368	3.7	4,000	5230
F30T8BLB	30	893	25.5	Straight	G13	0.365	352,368	6.3	4,000	2320
F36T8BLB	36	1,198	25.5	Straight	G13	0.43	352,368	8.1	5,000	2420
F40T10BLB	40	1,198	32.5	Straight	G13	0.42	352,368	8.1	5,000	2430
F40T10BLB/RS	40	1,198	32.5	Straight	G13	0.42	352,368	8.1	5,000	5430

Blacklight blue lamps (BLB) have shape, structural, electrical characteristics and lighting circuits similar to general fluorescent lamps used for illumination.

Therefore, ballasts and glow starters used for general fluorescent lamps can be used for black light blue lamps (BLB) of this type.

*1 Total amount of the ultraviolet between 300nm and 400nm.

*2 When the ultraviolet ray output becomes 60% of the initial output (after 100 hours lighting).



General lighting

BLB lighting (Fluorescent illumination)

Compact blacklight blue fluorescent lamps



Type	Lamp Wattage (W)	Dimensions(mm)			Cap (B)	Lamp Current (A)	Lamp Voltage (V)	Ultraviolet Output (W)	Average Useful Life (h)	No.60901 IEC
		A Max.	B Max.	C Max.						
FPX5BLB	5	28	13	85	G23	0.180	35	0.7	4,000	0005
FPX7BLB	7	28	13	115	G23	0.180	45	1.0	4,000	0007
FPX9BLB	9	28	13	145	G23	0.180	60	1.4	4,000	0009
FPX11BLB	11	28	13	215	G23	0.155	90	1.7	4,000	0011
FPX13BLB	13	28	13	170	GX23	0.285	59	2.0	4,000	0013
FPL5BLB/K	5	28	13	85	2G7	0.180	35	0.7	4,000	2005
FPL7BLB/K	7	28	13	115	2G7	0.175	47	1.0	4,000	2007
FPL9BLB/K	9	28	13	145	2G7	0.170	60	1.4	4,000	2009
FPL11BLB/K	11	28	13	215	2G7	0.155	91	1.7	4,000	2011
FPL18BLB/K	18	40	20	225	2G11	0.375	58	3.3	4,000	2218
FPL24BLB/K	24	40	20	320	2G11	0.345	87	5.1	4,000	2224
FPL36BLB/K	36	40	20	415	2G11	0.435	87	7.2	4,000	2236
FPL55BLB/K	55	40	20	533	2G11	0.540	106	10.2	4,000	—

Dimensions

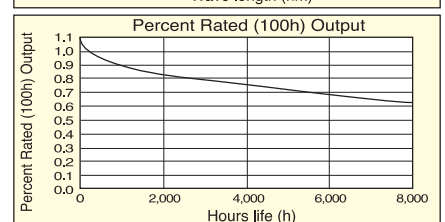
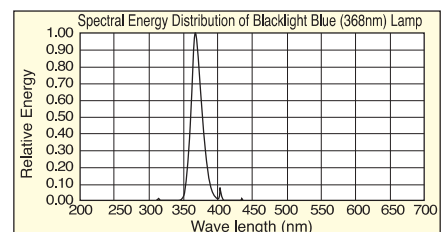
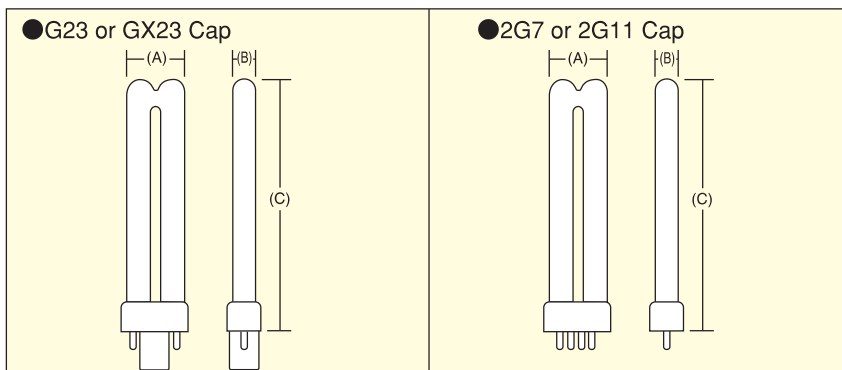

Blacklight lamps (BL)

Like BLB lamps, these lamps emit a highly concentrated radiation between 315nm and 400nm (peak at 352nm and 368nm).

Other specifications are similar to those of general fluorescent lamps for illumination.

They are used for trapping insects, luring lamps, photosensitization and photochemical reactions.



Type	Lamp Wattage (W)	Dimensions(mm)		Shape	Cap	Lamp Current (A)	Ultraviolet Output (W) ^{*1}	Average Useful Life (h) ^{*2}	No. 60081 IEC
		Length (L)	Diameter (D)						
F4T5BL	4	134.5	15.5	Straight	G5	0.162	0.5	3,000	1020
F6T5BL	6	210.5	15.5	Straight	G5	0.147	0.9	3,000	1030
F8T5BL	8	287	15.5	Straight	G5	0.170	1.4	3,000	1040
F10T8BL	10	330	25.5	Straight	G13	0.230	1.5	4,000	—
F15T8BL	15	436	25.5	Straight	G13	0.300	2.6	4,000	2120
F20T10BL	20	580, 588.5	32.5	Straight	G13	0.360	3.7	4,000	2230
F40T10BL	40	1,198	32.5	Straight	G13	0.420	8.1	5,000	2430

Blacklight lamps (BL) have shape, structural, electrical characteristics and lighting circuits similar to general fluorescent lamps used for illumination. Therefore, ballasts and glow starters used for general fluorescent lamps can be used for blacklight lamps (BL) of this type.

*1 Total amount of the ultraviolet between 315nm and 400nm.

*2 When the ultraviolet ray output becomes 60% of the initial output (after 100 hours lighting).

UV-B lamps

UV-B lamps emit ultraviolet rays between 280nm and 360nm (at peak 306nm).

The spectral energy distribution suits to test the ultraviolet resistance of paints, plastics and rubbers.

They are also used for the special light sources for inspection and analysis.



Type	Lamp Wattage (W)	Dimensions (mm)		Shape	Cap	Lamp Current (A)	Ultraviolet Output (W) ^{*1}	Average Useful Life (h) ^{*2}	No. 60081 IEC
		Length (L)	Diameter (D)						
G4T5E	4	134.5	15.5	Straight	G5	0.162	0.5	3,000	1020
G6T5E	6	210.5	15.5	Straight	G5	0.147	1.0	3,000	1030
G8T5E	8	287	15.5	Straight	G5	0.170	1.6	3,000	1040
G15T8E	15	436	25.5	Straight	G13	0.300	3.0	4,000	2120
G20T10E	20	588.5	32.5	Straight	G13	0.360	4.2	4,000	2230
G25T8E	25	436	25.2	Straight	G13	0.600	3.9	3,000	—
G40T10E	40	1,198	32.5	Straight	G13	0.420	9.3	5,000	2430

The shape, structural, electrical characteristics are the same as those of general fluorescent lamps used for illumination.

*1 After 100 hours lighting.

*2 When the ultraviolet ray output becomes 60% of the initial output (after 100 hours lighting).

WARNING The radiation of those lamps is harmful to eyes and skin. Protect your eyes and your skin against the ultraviolet rays.

Spectral Energy Distribution

● Germicidal Lamp

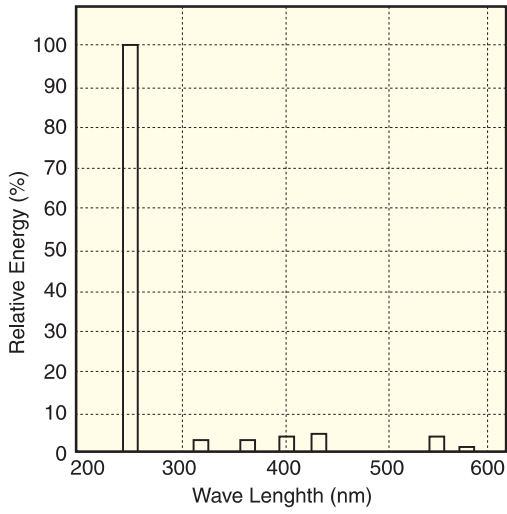

● Blacklight Blue Lamp (BLB)

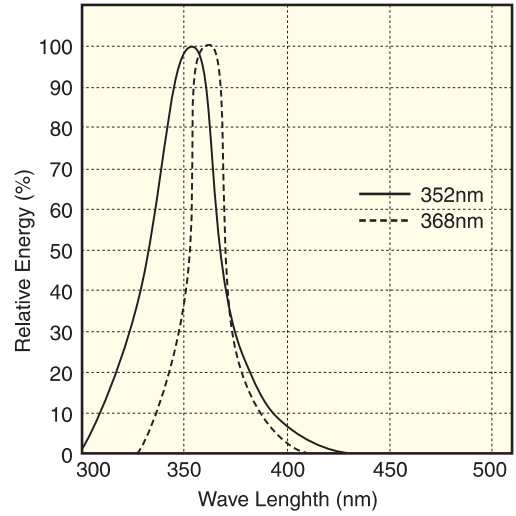

● UV-B Lamp

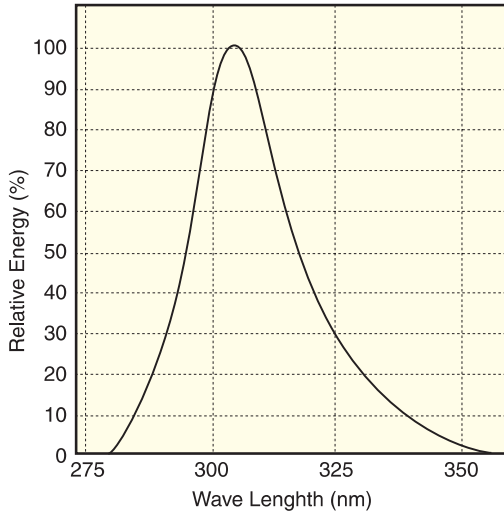

● Blacklight Lamp (BL)

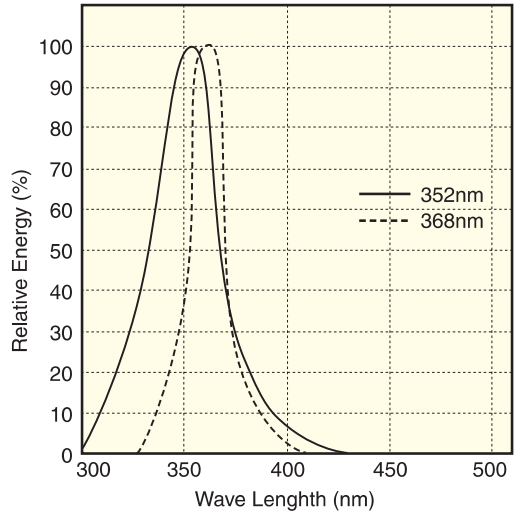

● Ozone Lamp

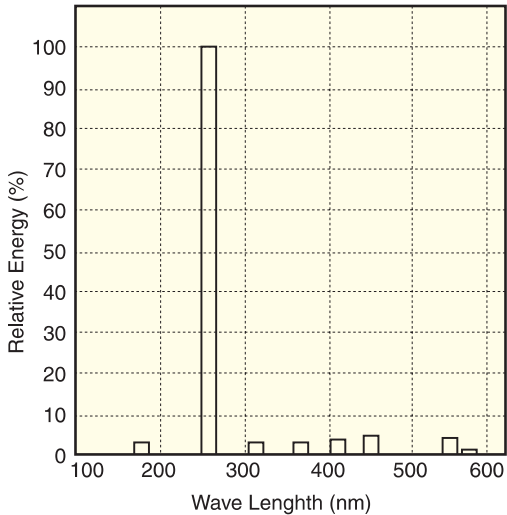



URL <http://www.sankyo-denki.co.jp>

1-35, Shin-machi, Hiratsuka-shi, Kanagawa-ken
254-0076, Japan

TEL: +81-463-31-7335

FAX: +81-463-34-5165