



ARKEN OPTICS



ZULUS HD 5-20X

**DIGITAL DAY / NIGHT
SCOPE**

CONTENTS

ZULUS HD 5-20X DIGITAL DAY / NIGHT SCOPE

ZULUS HD 5-20X

DIGITAL DAY / NIGHT SCOPE

Safety Instructions

Read and follow all instructions

Read all warnings!

Do not attempt to disassemble the device by yourself, all services must be provided by the manufacturer

CAUTION

- INFRAR-ED (IR) illuminator may cause harm to human eyes, DO NOT look directly at it.
- Switch off the IR illuminator when not in use. Continuous use of IR light will generates excessive heat. Avoid pointing it towards flammable objects.
- Operating temperature is between -4F-122F (-20~50°C).

Description

ZULUS HD 5-20 provides impressive day/night visual scanning, image capture and video recording capabilities all in an intuitive interface that provides multiple reticles and a secondary power option!

Package Content

- ZHD520 Scope
- Rail Accessories (M6 / M4 screws, mount, spanner, lens cleaning cloth)
- Eyepiece Protector
- USB Cable
- User Manual

■ Specifications

Model		ZULUS HD 5-20X
Sensor Specifications		
Resolution	1920 x 1080 Pixels	
Frame Rate	60Hz	
Video Record Resolution	1920 x 1080 Pixels	
Optical Specifications		
Digital Magnification	5 ~ 20x	
Eye Relief	45mm	
Diopter Adjustment	± 5D	
Detection Range	400M	
Display Specifications		
Type	Micro - OLED	
Display Resolution	1920 x 1080 Pixels	
Frame Rate	60Hz	
Battery Power Supply		
Battery Type	18650 Battery (flat-top)	
Operating Time	8h	
External Power Supply	5V - Type C USB	

Model		ZULUS HD 5-20X
Physical Specifications		
Net Weight	410g	
Gross Weight _(w/battery,mount,eyepiece protector)	539g	
Dimensions	201 *74 * 48mm	
Micro TF Card	32 ~128 (U1/C10)GB	
Ingress Protection	IP67	
WiFi / APP	Supported by Arken Optics	
IR Wavelength	850/940nm	
Infrared Power	5W	
Working Temperature	-20~50°C	

■ Features

- High Resolution Imaging
- Video Recording In 1920 x 1080 60 Hz
- Micro-OLED HD Display, 60 Hz
- Instantaneous Zeroing
- 3-Axis Gyroscope
- Picture-in-Picture Function
- Full-Color Under Low Light Conditions
- Anti-Backlight Overexposure Compensation
- Wi-Fi To App Direct Connection
- Wireless Firmware Updating Via App
- One Touch Zeroing Via App

Controls

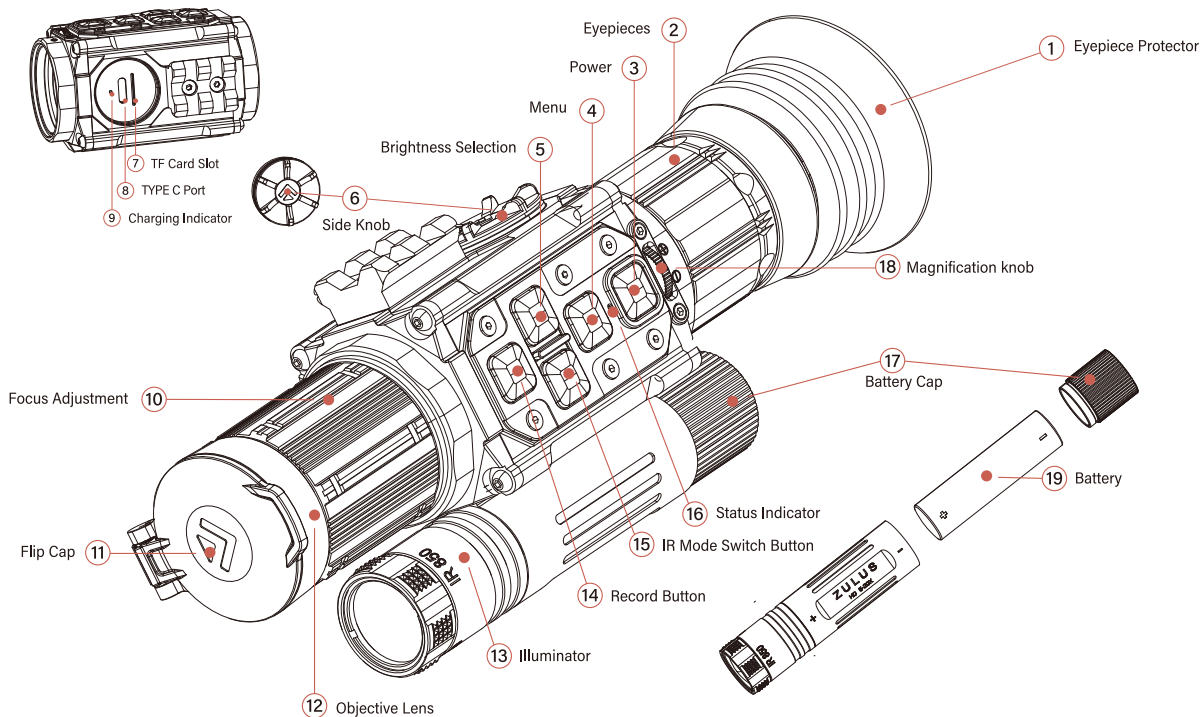

■ Power Supply

This device is powered by an external 18650 battery with up to 8 hours of operation time (when the IR mode switched off). When battery is low, it can either be charged independently or by connecting the device to TYPE-C port. Please note that it is recommended to fully charge the 18650 battery before initial use.

Installing the 18650 Battery (flat-top)

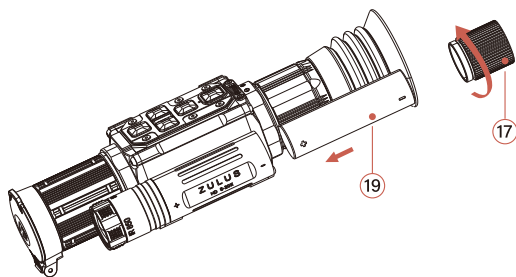

1. Open the Battery Cap (17) and pull it off.
2. Insert 18650 battery (19) into slot in the orientation indicated "+-".
3. Apply pressure to Battery Cap (17) against battery "-" and turn it until fully tightened.

TYPE-C Charging

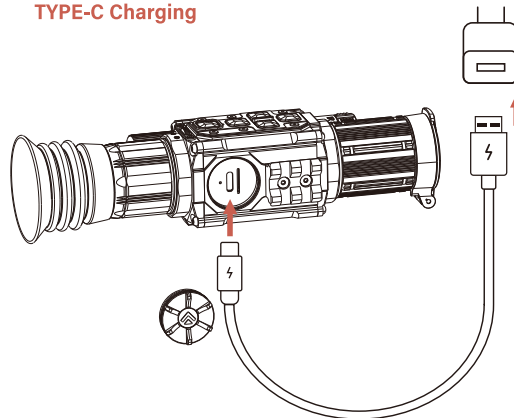

Note: To use TYPE-C cable for charging, a power adapter (5V2A) is needed.

TF Card Slot

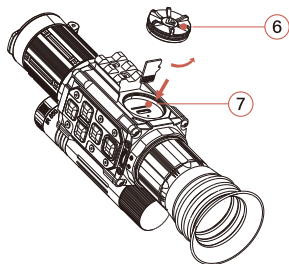

Open the Side Knob (6) insert TF card into the slot (7)

Note: TF card insert to certain direction.

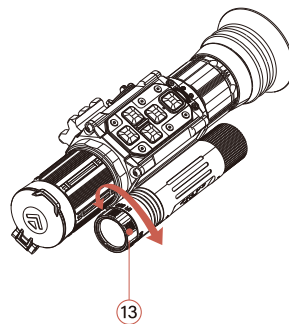



Rotate the Illuminator (13) to adjust brightness.



Note: Optimal focus enables maximum detection range.

Indicator

Indicator	Color	On	Flash
Charging (9)	●	Charging	--
Status (16)	●	Working	--
	●	Standby	Updating: Yellow light flashing

Control Description

Button	Status	Short Press	Long Press	Rotation
Power Button ③ 	Off	--	On	--
	View Interface	Standby	Off	--
	Standby	Wake-up	--	--
	Zeroing Interface	Freeze/Continue	--	--
Menu Button ④ 	View Interface	Reticle Color Switch	Menu Interface	--
	Primary Menu Interface	View Interface	--	--
	Secondary Menu Interface	Primary Menu Interface	--	--
IR Mode Switch Button ⑮ 	View Interface	--	Color Mode Switch	--
	Black/White Mode	IR Brightness Adjust	Color Mode	--
	Menu Interface	Move Cursor to the Left	--	--
	Zeroing Interface	Move Cursor to the Left	Save and Exit	--
	Time Setting Interface	Move Cursor to the Left	Save and Exit	--

Button	Status	Short Press	Long Press	Rotation
Brightness Button ⑤ 	View Interface	Display Brightness Adjustment	Wi-Fi On/Off	--
	Menu Interface	Move Cursor to the Right	--	--
	Zeroing Interface	Move Cursor to the Right	Exit Current Setting	--
	Time Setting Interface	Move Cursor to the Right	Exit Current Setting	--
Record Button ⑭ 	View Interface	Start Recording /Pause /Resume	Start/EndRecording	--
	Menu Interface	Confirm the Selection	--	--
	Reticle Zeroing Interface	Reticle X/Y Value Adjust Once	Reticle X/Y Value Continuous Adjust	--
Magnification knob ⑱ 	View Interface	--	--	To Right Increase the Magnification / To Left Decrease the Magnification
	Reticle Zeroing Interface	--	--	To Right Increase the Magnification / To Left Decrease the Magnification

Interface Description

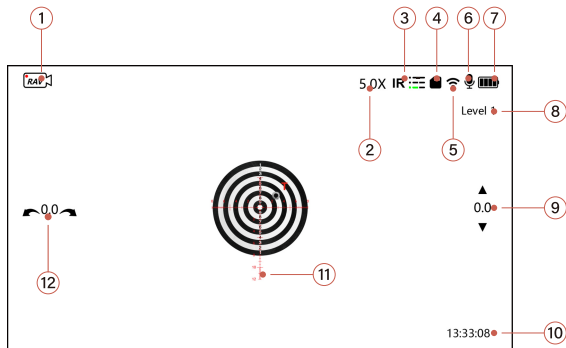

- ① Recording Indicator: The recording timer indicates that the device is currently recording; The displayed number on the timer represents the duration of the recorded video.
- ② Current Magnification (eg: 5.0x).
- ③ The displayed icon indicates if the device is in black and white mode; otherwise it is in color mode.

	Black and white mode; Illuminator off
	Brightness Level 1
	Brightness Level 2
	Brightness Level 3
	Brightness Level 4
	Brightness Level 5
	Black and white mode; Brightness will be adjusted automatically









- ④ TF card (Card icon appears when it's inserted. The recording won't work without the TF card).
- ⑤ WiFi (Wi-Fi On, Wi-Fi Off).
- ⑥ Microphone. Indicates whether sounds to be included when recording.
 Microphone On Microphone Off.
- ⑦ Battery Status





Icon	Status	Battery Status
	1 bar	10% ~ 20%
	2 bars	20% ~ 50%
	3 bars	50% ~ 80%
	4 bars	80% ~ 100%
	Charging	Connect Type C to charge

- ⑧ Level 1: Current Display Brightness (Level 1-6 with Increasing Brightness).
- ⑨ Gyroscope Vertical Drift.
- ⑩ Current Time.
- ⑪ Reticle.
- ⑫ Gyroscope Horizontal Drift.

Menu List

Long press Menu ④ for 2 seconds to enter Menu list; There are 15 selections in total; Use IR Mode Switch Button ⑮ and Brightness Button ⑤ to navigate through menu options; Short press the Record Button ⑭ to confirm selection.

Icon	Description
	[Recording] Auto Video Recording after Shooting
	[PiP] PiP Window on View Interface
	[Wi-Fi] Wi-Fi On/Off
	[Reticle Zeroing] Reticle Zeroing
	[Color Boost Mode] Select Mode: Color Boost/ Natural Color
	[Sound Record Control] Control whether to include sound in Recorded Video
	[Loop Recording] Set Video Duration : 1 Minute, 3 Minutes,5 Minutes or OFF (default 10 Minutes)
	[Gyro] Gyroscope Calibration
	[Timestamp] If Timestamp is Shown In Recorded Videos

Icon	Description
	[Date and Time Settings] Set Current Time and Date
	[Auto Sleep] In Auto Sleep Mode, The Device will Automatically Power OFF after 10, 20 or 30 Minutes of Inactivity
	[Language Setting] Language Selection
	[System Settings] Format the TF Card and Restore The Factory Default Settings
	[Version Number] Current Version <small>(Note : Formatting the TF card will erase all files stored on the card)</small>

Main Function Description

Reticle Zeroing

Long press the Menu Button (4) for 2 seconds to enter menu list.  Press the Brightness Button (5) to move cursor to Reticle Setting menu, then press Recording Button (14) to select Reticle Setting.

- Short press Brightness Button (5) to move cursor to the right; Short press the IR Mode Switch Button (15) to move cursor to the left;
- Short press Recording Button (14) to increase current value by 1; Long press (without release) to continuously increase the current value within the allowed range. Short press the Menu Button (4) to decrease current value by 1; Long press (without release) to continuously decrease the current value within the allowed range;
- Long press IR Mode Switch Button (15) for 2 seconds to save and exit Reticle Zeroing; Long press Brightness Button (5) to exit without saving;
- Short press Power Button (3) to freeze/reactivate current image.

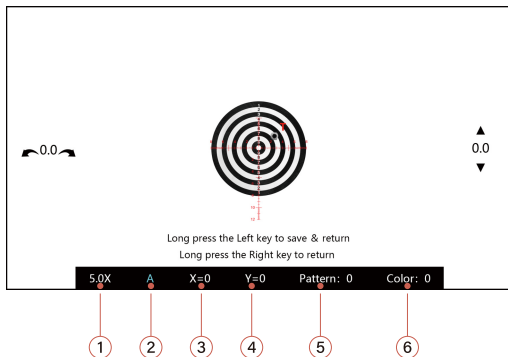

- ① 5.0x: Current objective magnification; adjustable with Magnification Knob (18)
- ② A: Current ballistic profiles; up to 26 (A-Z) profiles for reticle settings
- ③ X=0: Current coordinate point of reticle in horizontal direction
- ④ Y=0: Current coordinate point of reticle in vertical direction
- ⑤ Pattern: 4 reticle patterns
- ⑥ Color: 5 color options white(0), green(1), red(2), yellow(3), black(4)

Reticle Zeroing

Example

Place the target at 50 meters, turn Focusing Adjustment ⑩ to ensure the Objective Lens ⑫ provide a clear view of the target; Align the crosshairs with the target. The bullet hole will create an impact point (T). While keeping the current aiming point unchanged, short press the Power Button ③ to freeze current image. Move X and Y coordinates of the reticle to align cross hair center precisely with impact point (T).

Note: Once the reticle has been changed (either moved or changed pattern or color), the magnification cannot be adjusted

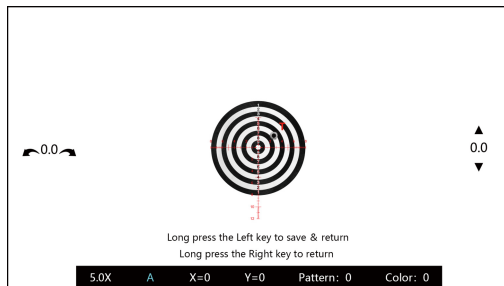

(Before Zeroing)

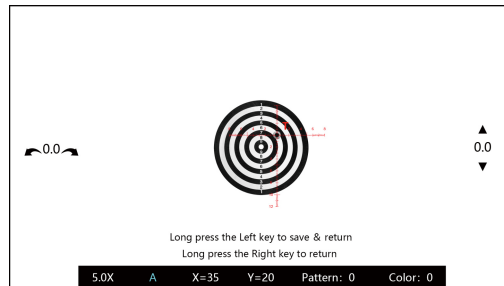

(After Zeroing)

Image Quality Enhancement Function

Multiple image qualities: natural images and color-enhanced images.



(Natural Mode: This is what human eye sees in real life)



(Color Boost Mode: Image with enhanced color)

■ App Instruction

Please search and download the " **Arken Optics** " App from the App store.

For **Android** phones, please go to **Google Play Store**

For **iOS** phones, please go to **Apple Store**

Search for " **Arken Optics** " to download the App.

App Connection and Use

[Step 1] After turning on the device, long press the Brightness Button **(5)** for 2 seconds to turn on Wi-Fi, the account (starting with ZHD520) and password (12345678) can be seen on the display.



[Step 2] Go to Wi-Fi setting on the phone to connect the device.

[Step 3] Open " **Arken Optics** " App and Enjoy!(User instruction is included in the App).

Firmware Update

Using the "Firmware Update" feature on the App to perform online OTA/Wireless Updates.

Reticle Zeroing on App

Tap the icon  on App. When in landscape mode, short press Power Button  to freeze current image; Swiftly move your finger from the reticle center to point of impact on the phone; Precise adjustment of X and Y coordinates can be done by tapping the up and down arrow on the App. Once the reticle center and the point of impact is perfectly aligned, click "OK" to complete the current Zeroing.

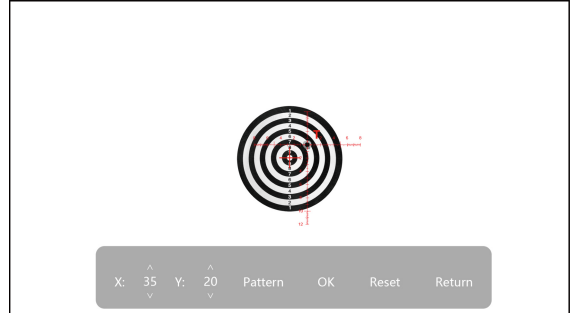
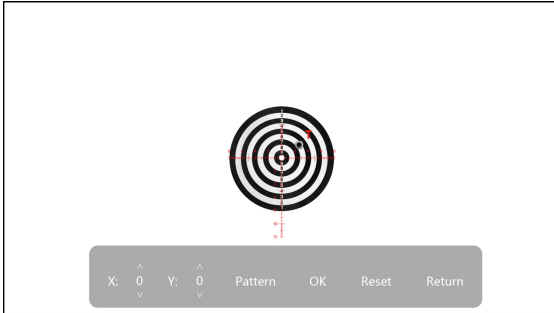

■ FCC WARNING

This device complies with part 15 of the FCC Rules. Operation is subject to the following two conditions: (1) this device may not cause harmful interference, and (2) this device must accept any interference received, including interference that may cause undesired operation.

Any changes or modifications not expressly approved by the party responsible for compliance could void the user's authority to operate the equipment.

NOTE: This equipment has been tested and found to comply with the limits for a Class B digital device, pursuant to Part 15 of the FCC Rules. These limits are designed to provide reasonable protection against harmful interference in a residential installation. This equipment generates, uses and can radiate radio frequency energy and, if not installed and used in accordance with the instructions, may cause harmful interference to radio communications. However, there is no guarantee that interference will not occur in a particular installation.

If this equipment does cause harmful interference to radio or television reception,

which can be determined by turning the equipment off and on, the user is encouraged to try to correct the interference by one or more of the following measures:

- Reorient or relocate the receiving antenna.
- Increase the separation between the equipment and receiver.
- Connect the equipment into an outlet on a circuit different from that to which the receiver is connected.
- Consult the dealer or an experienced radio/TV technician for help. The device has been evaluated to meet general RF exposure requirement. The device can be used in portable exposure condition without restriction.



WWW.ARKENOPTICSUSA.COM

Version3.0