

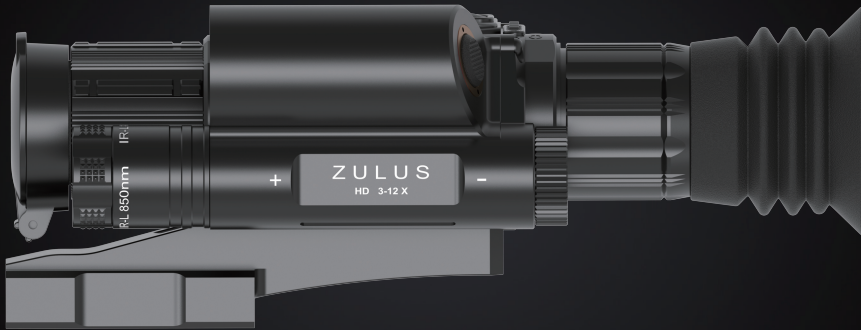

ARKEN OPTICS



**ZULUS HD LRF 3 - 12X**

**DIGITAL DAY / NIGHT  
SCOPE**

# CONTENTS

**ZULUS HD LRF 3-12X** DIGITAL DAY/NIGHT SCOPE

# ZULUS HD LRF 3-12X

DIGITAL DAY/NIGHT SCOPE

## Safety Instructions

Read and follow all instructions

Read all warnings!

Do not attempt to disassemble the device by yourself, all services must be provided by the manufacturer

## CAUTION

- ⦿ INFRARED (IR) illuminator may cause harm to human eyes, DO NOT look directly at it.
- ⦿ Switch off the IR illuminator when not in use. Continuous use of IR light will generate excessive heat. Avoid pointing it towards flammable objects.
- ⦿ Operating temperature is between -4F-122F ( -20~50°C).

## Description

ZHD312R, a 24/7 all-weather conditioned digital scope, with its excellent day and night time image quality, is specifically designed for outdoor hunting. Built-in high-precision laser rangefinder and leading ballistics algorithm make it easy to aim at the target quickly and accurately.

## Package Content

- ZHD312R Scope
- Rail Accessories (M6 / M4 screws, mount, spanner, lens cleaning cloth)
- Eyepiece Protector
- USB Cable
- User Manual

## ■ Specifications

Model ZULUS HD LRF 3-12X	
<b>Sensor Specifications</b>	
Resolution	1920 x 1080 pixels
Frame Rate	60Hz
Video Record Resolution	1920 x 1080 pixels
<b>Optical Specifications</b>	
Digital Magnification	3 ~ 12x
Eye Relief	45mm
Diopter Adjustment	± 5D
Recommended Scope Range	5~400M
<b>Display Specifications</b>	
Type	Micro - OLED
Display Resolution	1920 x 1080 pixels
Frame Rate	60Hz
<b>Power Specifications</b>	
Battery Type	18650 Battery(flat-top)
Operating Time	8h
External Power Supply	5V - Type C USB

Model ZULUS HD LRF 3-12X	
<b>Physical Specifications</b>	
Net Weight	469g
Gross Weight <sub>(w/battery,mount,eyepiece protector)</sub>	570g
Dimensions	192*79*53mm
Micro TF card	32 ~128 ( U1/C10 ) GB
Ingress Protection	IP67
WIFI / APP	Support (Arken Optics) / Arken Ballistics
IR Wavelength	Vscl:850/940nm LED:850nm
Infrared Power	5W
Working Temperature	-20~50°C
Bluetooth Function	Support
Laser Rangefinder Detection Range	5~1000M



## ■ Features

- High Resolution Imaging
- Video Recording In 1920 x 1080 60 Hz
- Micro-OLED HD Display, 60 Hz
- Instantaneous Zeroing
- 3-Axis Gyroscope
- Picture-in-Picture Function
- Full-Color Under Low Light Conditions
- Anti-Backlight Overexposure Compensation
- Wi-Fi to App Direct Connection
- Wireless Firmware Updating Via App
- One Touch Zeroing Via App
- Precise Ranging and Leading Ballistic Calculation
- Customized Ballistic Table

## Controls

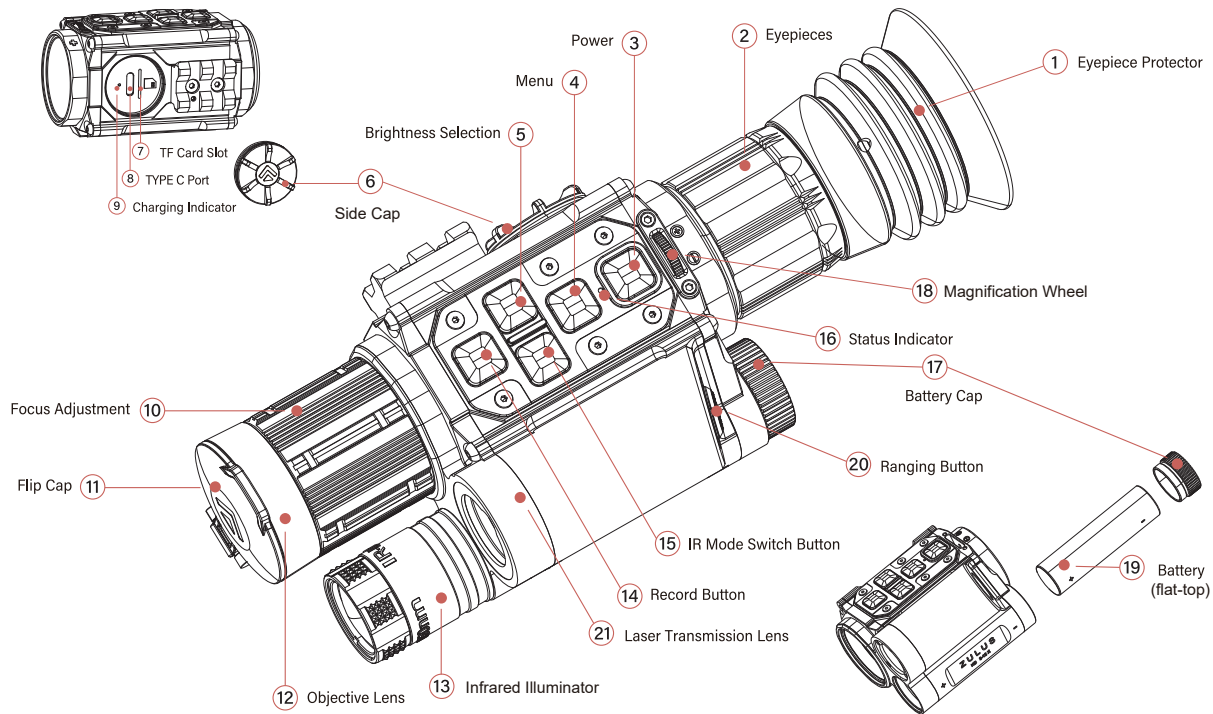

## ■ Power Supply

This device is powered by an external 18650 battery with up to 8 hours of operation time (when the IR mode switched off). When battery is low, it can either be charged independently or by connecting the device to TYPE C port. Please note that it is recommended to fully charge the 18650 battery before initial use.

Note: Please purchase genuine 18650 battery from regular channels. Any problems arising from inferior 18650 battery purchased by the user shall be borne by the user himself.

### Installing the 18650 Battery (flat-top)

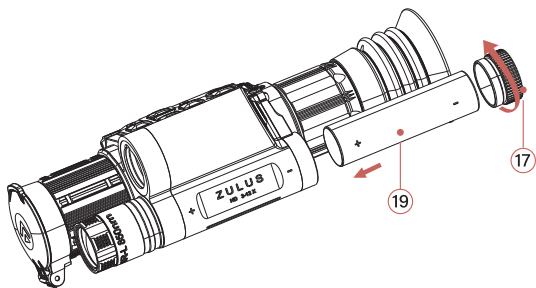

1. Open the Battery Cap (17) and pull it off.
2. Insert 18650 Battery (19) into slot in the orientation indicated "+".
3. Apply pressure to Battery Cap (17) against battery "-" and turn it until fully tightened.

### TYPE-C Charging

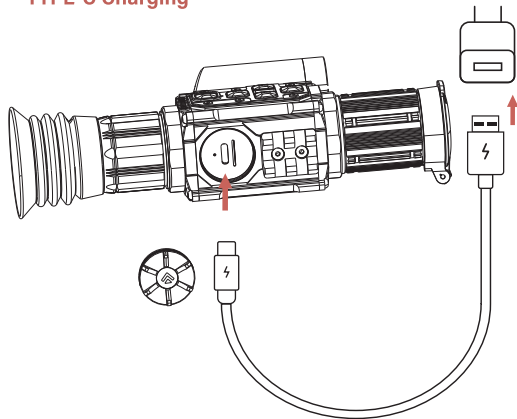

Note: To use TYPE-C cable for charging, a power adapter (5V2A) is needed.

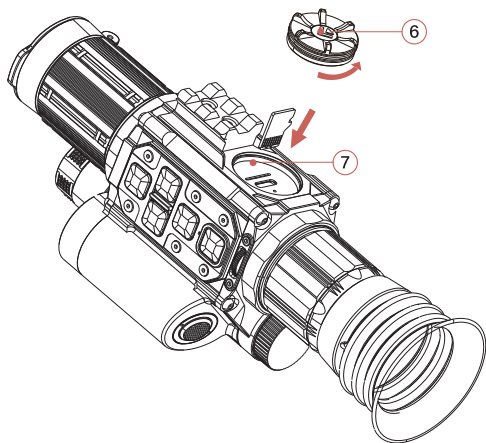

## TF Card Slot



Open the Side Cap ⑥ insert TF card into the slot ⑦

Note: TF card insert to certain direction.

## Indicator

Indicator	Charging (9)	Status (16)	
Color			
On	Charging	Working	Standby
Flash	--	--	Updating: Yellow light flashing

## ■ IR Illuminator

Please select the identical IR Torch type on software with the actual attached IR Torch type.

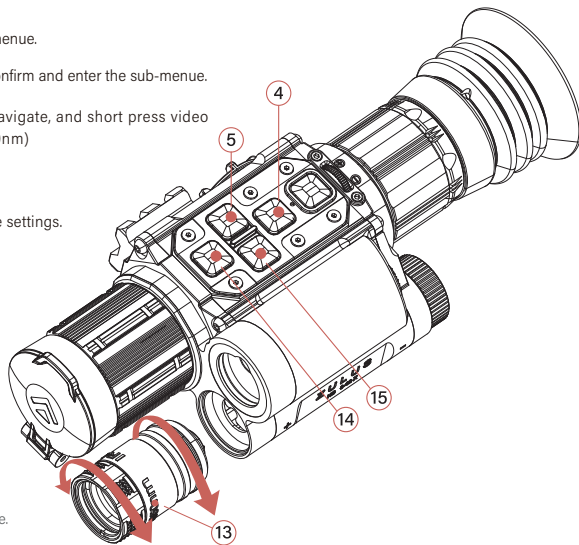

- Long press system Menu button (4) enter setting menu.
- Short press IR button (15) and screen brightness button (5) to navigate through the menu.
- Select the IR Torch Types  and short press video recording button (14) to confirm and enter the sub-menu.
- Continue short press the IR button (15) and screen brightness button (5) to navigate, and short press video recording button (14) to confirm the available IR Torch.(IR-L 850nm/ IR-V 850nm)
- Short press video recording button (14) to confirm or cancel the selection.
- Short press the system Menu button (4) exit the setting menu and complete the settings.



Rotate the IR Illuminator (13) to adjust brightness. Optimal focus enables maximum detection range.

Note: IR Illuminator (13) is replaceable.

## Control Description

Button	Status	Short Press	Long Press	Rotation
<b>Power Button</b> ③ 	Off	--	On	--
	View Interface	Standby	Off	--
	Standby	Wake-up	--	--
	Zeroing Interface	Freeze/Continue	--	--
<b>Menu Button</b> ④ 	View Interface	Reticle Color Switch	Menu Interface	--
	Primary Menu Interface	View Interface	--	--
	Secondary Menu Interface	Primary Menu Interface	--	--
<b>IR Mode Switch Button</b> ⑮ 	View Interface	--	Color Mode Switch	--
	Black/White Mode	IR Brightness Adjust	Color Mode	--
	Menu Interface	Move Cursor to the Left	--	--
	Zeroing Interface	Move Cursor to the Left	Save and Exit	--
	Time Setting Interface	Move Cursor to the Left	Save and Exit	--

Button	Status	Short Press	Long Press	Rotation
<b>Brightness Button</b> ⑤ 	View Interface	Display Brightness Adjustment	Wi-Fi On/Off	--
	Menu Interface	Move Cursor to the Right	--	--
	Zeroing Interface	Move Cursor to the Right	Exit Current Setting	--
	Time Setting Interface	Move Cursor to the Right	Exit Current Setting	--
<b>Record Button</b> ⑭ 	View Interface	Start Recording /Pause /Resume	Start/End Recording	--
	Menu Interface	Confirm the Selection	--	--
	Reticle Zeroing Interface	Reticle X/Y Value Adjust Once	Reticle X/Y Value Continuous Adjust	--
<b>Magnification Wheel</b> ⑱ 	View Interface	--	--	To Right Increase the Magnification / To Left Decrease the Magnification
	Reticle Zeroing Interface	--	--	To Right Increase the Magnification / To Left Decrease the Magnification
<b>Ranging Button</b> ⑳ 	Fail to Connect App Bluetooth	Show/Hide Ranging Icons and Distances	Turn Off Ranging	--
	Connected to App Bluetooth	Ranging and Ballistic Calculation	Turn Off Ranging	--

## Interface Description

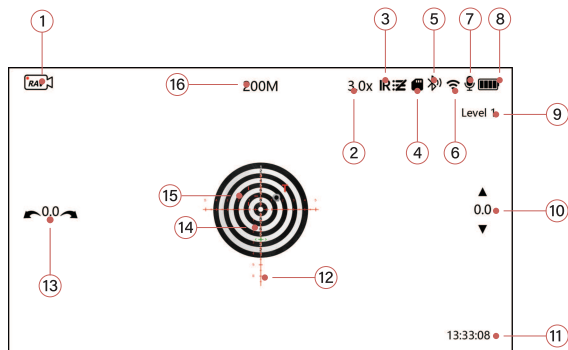

- ① Recording Indicator: The recording timer indicates that the device is currently recording; The displayed number on the timer represents the duration of the recorded video.
- ② Current Magnification ( eg: 3.0x ).
- ③ The displayed icon indicates if the device is in black and white mode; otherwise it is in color mode.

Vscel: 850/940nm		Black and white mode; Illuminator off
		Brightness Level 1
		Brightness Level 2
		Brightness Level 3
		Brightness Level 4
		Brightness Level 5
		Black and white mode; Brightness will be adjusted automatically

LED: 850nm		Black and white mode; Illuminator off
		Brightness Level 1
		Brightness Level 2
		Brightness Level 3
		Black and white mode; Brightness will be adjusted automatically









- ④ TF card ( Card icon appears when it's inserted. The recording won't work without the TF card).
- ⑤ Bluetooth ( Bluetooth on, Bluetooth off, Bluetooth Connected).
- ⑥ WiFi ( Wi-Fi On, Wi-Fi Off ).
- ⑦ Microphone, Indicates whether sounds to be included when recording.  
 Microphone On Microphone Off.
- ⑧ Battery Status





Icon	Status	Battery Status
	1 bar	10% ~ 20%
	2 bars	20% ~ 50%
	3 bars	50% ~ 80%
	4 bars	80% ~ 100%
	Charging	Connect Type C to charge

- ⑨ Level 1: Current Display Brightness (Level 1-6 with Increasing Brightness).
- ⑩ Gyroscope Vertical Drift.
- ⑪ Current Time.
- ⑫ Reticle.
- ⑬ Gyroscope Horizontal Drift.
- ⑭ Point of Impact.
- ⑮ Ranging Icon.
- ⑯ Ranging Distance.

## Menu List

Long press Menu ④ for 2 seconds to enter Menu list; There are 15 selections in total; Use IR Mode Switch Button ⑮ and Brightness Button ⑤ to navigate through menu options; Short press the Record Button ⑭ to confirm selection.

Icon	Description
	<b>[Recording]</b> Auto Video Recording after Shooting
	<b>[PiP]</b> PiP Window on View Interface
	<b>[Wi-Fi]</b> Wi-Fi On/Off
	<b>[Reticle Zeroing]</b> Reticle Zeroing
	<b>[Color Boost Mode]</b> Select Mode: Color Boost/ Natural Color
	<b>[Sound Record Control]</b> Control whether to include sound in Recorded Video
	<b>[Loop Recording]</b> Set Video Duration : 1 Minute, 3 Minutes,5 Minutes or OFF (default 10 Minutes)
	<b>[Gyro]</b> Gyroscope Calibration
	<b>[Ballistics Calculation]</b> Ballistics Calculation

Icon	Description
	<b>[Ranging Unit]</b> Select the Unit of Distance
	<b>[Aiming Method]</b> Select "Dial-in" or "Holdover" to Target
	<b>[IR Torch Types]</b> IR_L 850nm(acquiesce), IR_V 850nm
	<b>[Bluetooth]</b> Turn On or Turn Off Bluetooth
	<p><b>[System Settings]</b> Auto Sleep; Whether Display the Time When Recording; Current Version; Set the Current Time; Date and Language; Format the TF Card and Restore the Factory Default Settings.</p> <p>(Note : Formatting the TF card will erase all files stored on the card)</p>



## Main Function Description

### Reticle Zeroing

Long press the Menu Button (4) for 2 seconds to enter menu list.  Press the Brightness Button (5) to move cursor to Reticle Setting menu, then press Recording Button (14) to select Reticle Setting.

- Short press Brightness Button (5) to move cursor to the right; Short press the IR Mode Switch Button (15) to move cursor to the left;
- Short press Recording Button (14) to increase current value by 1; Long press (without release) to continuously increase the current value within the allowed range. Short press the Menu Button (4) to decrease current value by 1; Long press (without release) to continuously decrease the current value within the allowed range;
- Long press IR Mode Switch Button (15) for 2 seconds to save and exit Reticle Zeroing; Long press Brightness Button (5) to exit without saving;
- Short press Power Button (3) to freeze/reactivate current image.

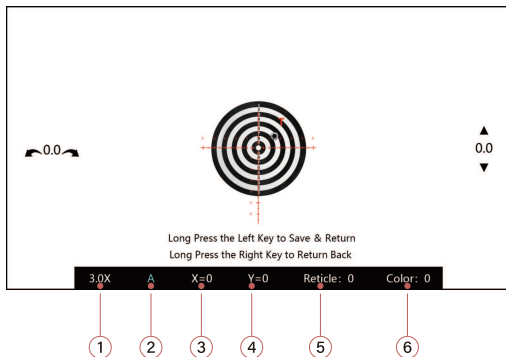

- ① 3.0x: Current objective magnification; adjustable with Magnification Knob (18)
- ② A: Current ballistic profiles.; up to 26 (A-Z) profiles for reticle settings
- ③ X=0: Current coordinate point of reticle in horizontal direction
- ④ Y=0: Current coordinate point of reticle in vertical direction
- ⑤ Reticle: 4 reticle shapes
- ⑥ Color: 4 color options white(0) , green(1) , red(2) , yellow(3), black(4)

## Reticle Zeroing

### Example

Place the target at 50 meters, turn Focusing Adjustment ⑩ to ensure the Objective Lens ⑫ provide a clear view of the target; Align the crosshairs with the target. The bullet hole will create an impact point (T). While keeping the current aiming point unchanged, short press the Power Button ③ to freeze current image. Move X and Y coordinates of the reticle to align cross hair center precisely with impact point (T).

Note: Once the reticle has been changed (either moved or changed Shape or color), the magnification cannot be adjusted.



(Before Zeroing)



(After Zeroing)

## Distance Measurement Function

On the ballistic calculation menu, if you select "Off" or fail to connect the mobile phone App Bluetooth to the device Bluetooth, the device will only measure the distance:

- Short press the Ranging Button to turn on the distance measuring function. The Ranging Icon **15** and current targeting distance **16** will display on the screen (It will automatically and continuously measure the distance once the distance measurement function is turned on).
- Continue to short press or long press the Ranging Button for 1.5 seconds to turn off the distance measurement function. The Ranging Icon and current distance will not displayed on the screen.



(First short press Ranging Button)



(Long press Ranging Button for 1.5 seconds)

## Ballistic Calculation - Real-time Calculation

- Enter the menu list, press the Ballistic Calculation, select the real-time ballistic calculation, and turn on the Bluetooth at the same time.
- Connect the device's Bluetooth via the Arken Ballistics App (the Bluetooth name of the device is ZHD312R and it can be viewed in the version interface)
- After determining the ranging target, short press the device ranging button to transmit the measured distance to the App, which performs the ballistic calculation and sends the result back to the device and displays on the screen.

## Ballistic Calculation - Ballistic Table

- Enter the menu list, press the Ballistic Calculation and select "Ballistic Table Query", turn on the Bluetooth at the same time (when there is a ballistic table on the device, you don't need to turn on the Bluetooth any longer).
- Click the Send Icon  to update the App Ballistic Table to the device. The device will use the App transmitted data in the ballistic table to perform ballistic calculation and display the result on the screen.

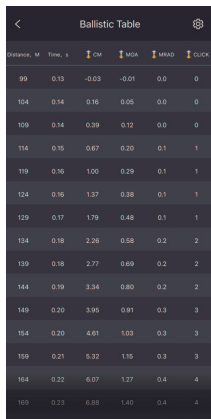

Distance, M	Time, s	CM	MRAD	CLICE	
99	0.13	-0.03	-0.01	0.0	0
104	0.14	0.16	0.05	0.0	0
109	0.14	0.39	0.12	0.0	0
114	0.15	0.67	0.20	0.1	1
119	0.16	1.00	0.29	0.1	1
124	0.16	1.37	0.38	0.1	1
129	0.17	1.79	0.48	0.1	1
134	0.18	2.26	0.58	0.2	2
139	0.18	2.77	0.69	0.2	2
144	0.19	3.34	0.80	0.2	2
149	0.20	3.95	0.91	0.3	3
154	0.20	4.61	1.03	0.3	3
159	0.21	5.32	1.15	0.3	3
164	0.22	6.07	1.27	0.4	4
169	0.23	6.85	1.40	0.4	4

(BC ballistic table interface)

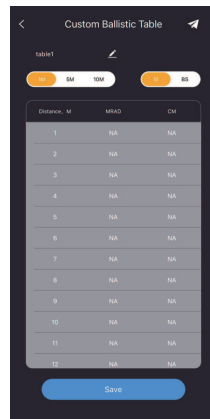

Distance, M	MRAD	CM
1	NA	NA
2	NA	NA
3	NA	NA
4	NA	NA
5	NA	NA
6	NA	NA
7	NA	NA
8	NA	NA
9	NA	NA
10	NA	NA
11	NA	NA
12	NA	NA

(Customized ballistic table interface)

## Aiming Method - Holdover

Enter Menu Options, Aiming Point Method: Select "Holdover".

- First short press the Ranging Button to activate the ranging function, the Ranging Icon (15) and distance (16) will display on the screen and the aiming point won't.
- Second short press the Ranging Button: after determining the target, short press on the Ranging Button, the Ranging Icon (15) disappears, the distance (16) is displayed, and the moving aiming point (14) is displayed (ie. the point of impact by ballistic calculation).
- Third short press the Ranging Button: Ranging Icon (15) and distance (16) are displayed, the aiming point disappears.
- Long press the Ranging Button for 1.5 seconds to return to the status when ranging was not activated: the Ranging Icon (15) and distance (16) disappear.



(First short press Ranging Button)



(Second short press Ranging Button)



(Third short press Ranging Button)



(Long press Ranging Button for 1.5 seconds)

## Aiming Method- Dial in

Enter Menu Options, Aiming Method: Select "Dial in"

- First short press the Ranging Button to activate the ranging function; the Ranging Icon **15** and distance **16** will display on the screen.
- Second short press the Ranging Button: Ranging Icon **15** disappears, distance **16** is displayed, and the Reticle automatically moves to the ballistic impact point.
- Third short press the Ranging Button: the Ranging Icon **15** and distance **16** are displayed and Reticle returns to its original position.
- Long press the Ranging Button for 1,5 seconds to return to the status when the Ranging was not activated: the Ranging Icon **15** and distance **16** disappear.



(First short press Ranging Button)

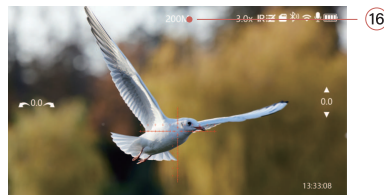

(Second short press Ranging Button)

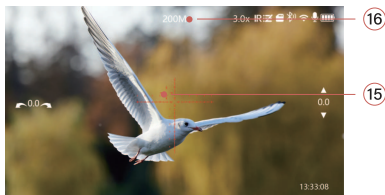

(Third short press Ranging Button)



(Long press Ranging Button for 1.5 seconds)

## Image Quality Enhancement Function

Multiple image qualities: natural images and color-enhanced images.



(Natural Mode: This is what human eye sees in real life)



(Color Boost Mode: Image with enhanced color)

## ■ App Instruction-Arken Optics

Please search and download the " Arken Optics " App from the App store.

For Android phones, please go to [Google Play Store](#).

For iOS phones, please go to [Apple Store](#).

Search for " Arken Optics " to download the App.

### App Connection and Use

**【Step 1】** After turning on the device, long press the Brightness Button (5) for 2 seconds to turn on Wi-Fi, the account (starting with ZHD312R) and password (12345678) can be seen on the display.

**【Step 2】** Go to Wi-Fi setting on the phone to connect the device.

**【Step 3】** Open "Arken Optics" App and Enjoy!(User instruction is included in the App).



## ■ App Instruction-Arken Ballistics

If trying to use the ballistics calculation function, you need to download the [Arken Ballistics APP](#).

For [Android](#) phones, please go to [Google Play Store](#).

For [iOS](#) phones, please go to [Apple Store](#).

Search for " [Arken Ballistics](#) " to download the App.

### App Connection and Use

**【Step 1】** Turn on Bluetooth on the phone, Bluetooth on the device and Ranging Button.



**【Step 2】** Click the Bluetooth Icon  in the App interface, it will jump to the Bluetooth connection interface when first connecting, and then enter the device name to connect.

After successful connecting, the last Bluetooth device will be connected by default.

## Firmware Update

Using the "Firmware Update" feature on the App to perform online OTA/Wireless Updates.

## Reticle Zeroing on App

Tap the Icon  on App. When in landscape mode, short press Power Button  to freeze current image;  
Swiftly move your finger from the reticle center to point of impact on the phone; Precise adjustment of X and Y coordinates can be done by tapping the up and down arrow on the App. Once the reticle center and the point of impact is perfectly aligned, click "OK" to complete the current Zeroing.

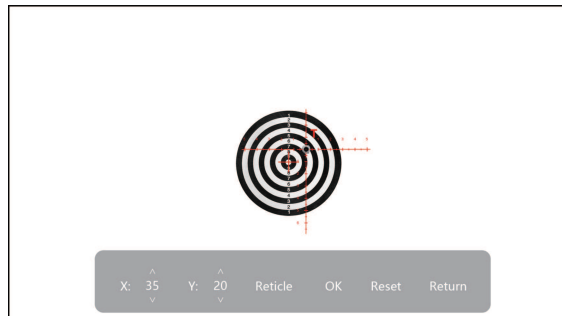
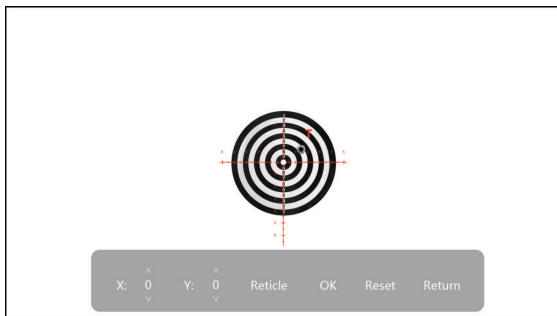

## ■ FCC WARNING

This device complies with part 15 of the FCC Rules. Operation is subject to the following two conditions: (1) this device may not cause harmful interference, and (2) this device must accept any interference received, including interference that may cause undesired operation.

Any changes or modifications not expressly approved by the party responsible for compliance could void the user's authority to operate the equipment.

NOTE: This equipment has been tested and found to comply with the limits for a Class B digital device, pursuant to Part 15 of the FCC Rules. These limits are designed to provide reasonable protection against harmful interference in a residential installation. This equipment generates, uses and can radiate radio frequency energy and, if not installed and used in accordance with the instructions, may cause harmful interference to radio communications. However, there is no guarantee that interference will not occur in a particular installation.

If this equipment does cause harmful interference to radio or television reception,

which can be determined by turning the equipment off and on, the user is encouraged to try to correct the interference by one or more of the following measures:

- Reorient or relocate the receiving antenna.
- Increase the separation between the equipment and receiver.
- Connect the equipment into an outlet on a circuit different from that to which the receiver is connected.
- Consult the dealer or an experienced radio/TV technician for help. The device has been evaluated to meet general RF exposure requirement. The device can be used in portable exposure condition without restriction.



[WWW.ARKENOPTICS.COM](http://WWW.ARKENOPTICS.COM)