



**YardCraft**<sup>®</sup>  
rediscover life outdoors



# Fairmont Garden Shed Garage

## Assembly Instructions

866-210-9273  
[info@yardcraft.com](mailto:info@yardcraft.com)



# YardCraft®

rediscover life outdoors

Thank you for the purchase of this Garden Building. This manual is designed to simplify the assembly process; however we recommend having an experienced carpenter involved in the project. **Please read through the entire manual before starting!**

The Garden Building put together for this manual was a 12'x26'. This manual can also be used for other sizes. It took 3 men approximately 20 hours using the tools shown. However; it may take you longer, since it will probably be a new project for you.

Take a deep breath and get at it; the satisfaction and enjoyment of this Garden Building awaits! Have Fun!

**You have purchased a product that consists of heavy, bulky pieces. With your purchase, you assume full responsibility to have the necessary manpower and/or equipment to unload the items. You also agree that any damage that happens to the equipment, product, or individuals during the entire construction process, is your responsibility, and neither the seller, nor the manufacturer, will be held liable for any such damage.**

**In addition to the materials provided you will need approximately 14 bundles of shingles, 2 bundles cappers, 5 gallons of paint for the siding, 1 gallon paint for the trim, and one tube of caulk.**

**If you decide to go with a concrete foundation, you will need 70' of 3-1/2" sill sealer for the sill plate.**

## **Tools Required For Job**

- Hammer
- Screw Gun
- Tape Measure
- Tin Snips
- Chalk Line
- Carpenter Square
- (2) Step Ladders
- 5/32 Allen Wrench
- Carpenter Pencil
- Circular Saw
- Sawzall
- 5/16 Drill Bit

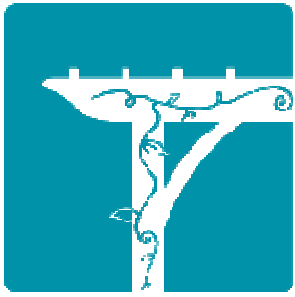

# YardCraft®

rediscover life outdoors

## Shed Pad Preparation



### Site Preparation

The best thing you can do to contribute to the longevity of your new building is to install a quality pad. We recommend a minimum of a 6-12" crushed stone base, at least 2' larger than your building in both directions. Crushed stone allows for drainage should any moisture get underneath your shed.

Drainage is of utmost importance, as the greatest enemy to any shed is moisture. If you look at older sheds around your neighborhood, you will notice that many of them are beginning to rot around the bottom of the structure. This is because most, if not all, of those sheds do not have a prepared base underneath them. As rain falls from the edge of the roof, it deflects off of the ground and splashes onto the sidewalls of the shed. Over the years, this will cause the doors and lower siding of these sheds to rot. Using stone as a base, the water is able to be absorbed into the ground instead of splashing against your building.

**Important ! If you decide to go with a concrete foundation, it is crucial to go exactly the size of building, and to make sure the foundation is square. The foundation also needs to be level for an efficient building process!**

# Unpack The Kit



(1) Place the package as close to the assembly location as possible.



(2) Cut package bands.  
**Note:** Floor unit is packaged separately.



(3) Remove and organize parts from package.

## If You Got A Floor With This Unit, (Skip Steps 4-9)

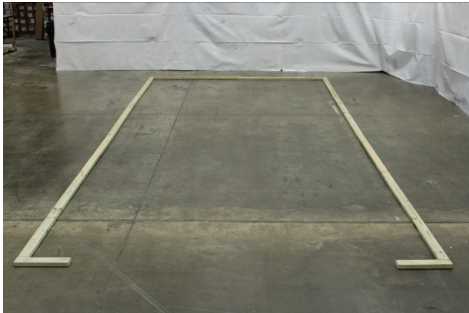

(4) Locate and lay out the 6' pressure treated 2x4 Sill Plates, cutting them to length as needed.  
**NOTE: Perimeter needs to be square, and exactly 12'x26'**



(5) Fasten the sill sealer (**Not provided**) to the bottom of the sill plate. (**You will need approximately 70 feet**)



(6) After making sure the sill plates are in the proper position, pre drill holes, then fasten to the foundation, using 3" Tapcon screws, (**Not provided**)



(7) After all the walls are set, permanently anchor the walls, first; pre-drilling the holes, using a 1/2" concrete bit, (**Not provided**) then, move to next step.

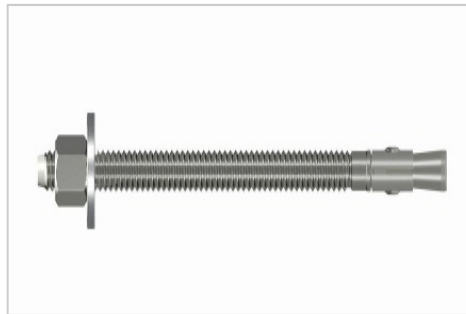

(8) Fasten the walls to the foundation, using 1/2" x 7" galvanized wedge anchors, (**Not provided**) and space them every 4 to 6 feet, or according to local code requirements.

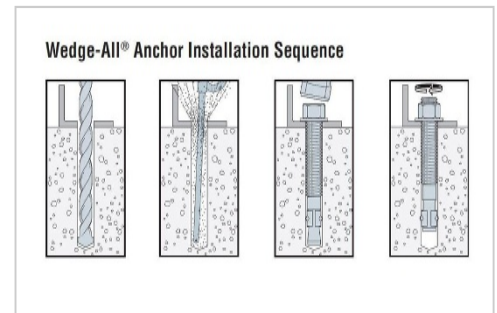

(9) Ask your local hardware department for any additional info on how to properly install the anchoring system, or refer to the video at [www.youtube.com/watch?v=3JI\\_9ggbmcY](http://www.youtube.com/watch?v=3JI_9ggbmcY)

# Assemble Floor



(10) Locate the parts to assemble the floor joists.



(11) Push joists tightly together, and align the OSB scabs flush with the floor joists. Then; nail the OSB scab, using twelve 2" nails per Scab.  
Flip the joist, then repeat on opposite side.

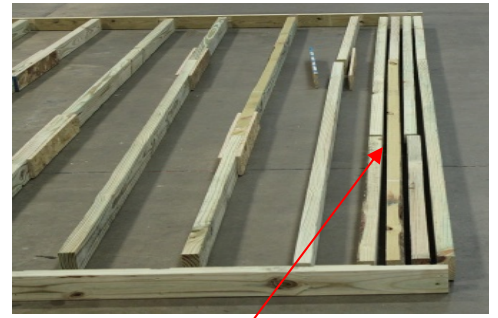

(12) Repeat with all the joists except four, as shown here. Then lay out all the joists.  
**Note: Alternate all the joists as shown.**

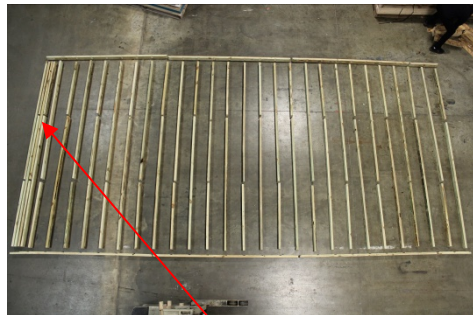

(13) Finish laying the joists and band boards out as shown.  
**Note: Garage door sill consists of four joists nailed together.**



(14) The band boards have dado grooves precut to ensure proper joist placement.  
The narrow grooves should both be placed at the splice.



(15) The wider grooves should be placed at the ends.

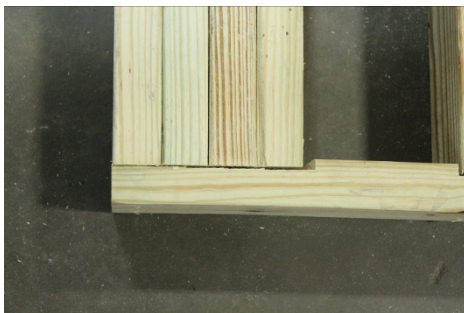

(16) The 6" dado grooves should be placed at the garage door sill.



(17) Attach the band board, using 3" screws, through the pre-drilled holes. Make sure the floor joists are flush with the band board as shown.



(18) Screw the rest of the band-boards into floor joists.  
**Important!** Band board splice needs to be tight.

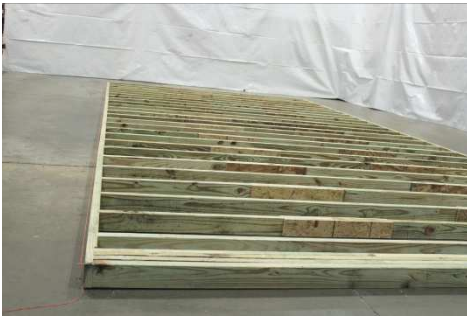

**(19)** Continue until floor is complete.

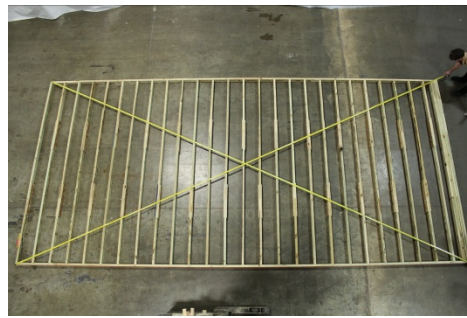

**(20)** Before proceeding, ensure that floor is square. Both measurements need to be equal.

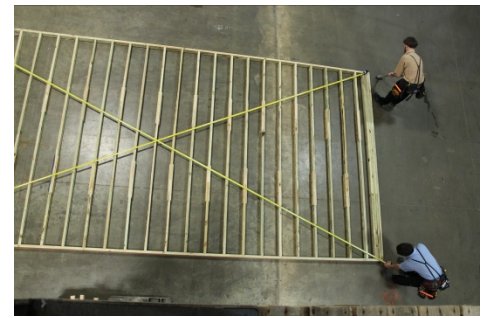

**(21)** Knock the joists on the end accordingly, till measurements are equal.

## Install Flooring



**(22)** Layout the flooring as shown.



**(23)** Start on the front left corner with a full 4'x8' piece, making sure flooring is flush with floor joists.



**(24)** Attach the corner of the flooring, using 2" nails.



**(25)** Nail along the gable, again; making sure flooring is flush with the floor joist. Use an 8" to 12" nail spacing.



**(26)** Nail along the front side, making sure flooring is flush with the band board.

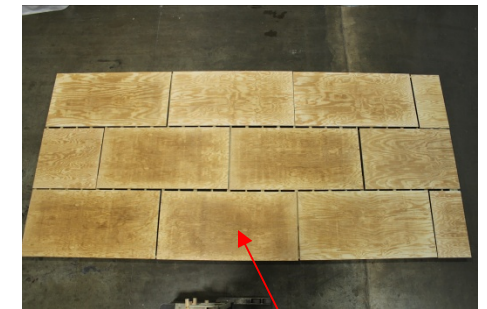

**(27)** Put the next piece in place, then refer to following step.



**(28)** Center the floor joist evenly with the flooring splice, then nail the corner, after making sure flooring is tight against, and flush with the previous piece.



**(29)** Nail the front corner as shown, making sure the flooring is tight against previous piece, then nail along the splice.



**(30)** Nail along the front side, again; making sure flooring is flush with the band board. Repeat previous steps with the rest of the front row.



**(31)** Before you finish attaching the first row flooring to the joist, make marks 12" on center for a guide to adjust the joist when nailing. Then finish nailing the first row flooring.



**(32)** Nail the rest of the flooring, using the previous steps, and using the layout shown.



**(33)** Finally, make sure flooring is nailed to all floor joists, then you are ready for wall placement.

## Assemble Back Wall Frame

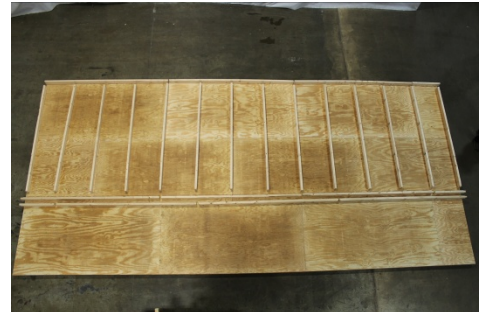

**(34)** Locate and lay out the parts to assemble the back wall.  
**Note: (Dados are 24" on center) Single plate belongs towards the bottom, and double plate towards the top.**



**(35)** Be sure to alternate the double, top wall plate splices.



**(36)** Insert two 3" screws through the pre-drilled holes to attach bottom plate to each wall stud. Make sure bottom plate and wall studs are flush.



**(37)** Repeat the process for the rest of the wall studs; but use four 3" screws as shown, for any splice.



**(38)** Attach all wall studs to top and bottom and wall plate.



**(39)** Before fastening the double top wall plate, ensure that dado grooves align with wall studs, and are faced outward.



**(40)** Attach top plate, using 3" screws.

## Install Back Wall Siding



**(41)** Lay out siding as shown here, with the overlap towards the left.

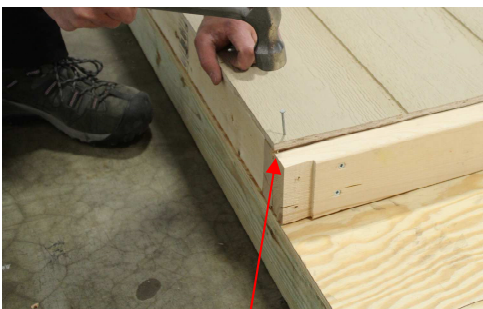

**(42)** Starting with the left piece, place the siding even with the center of the double top plate, and 1/2" out over the wall stud.



**(43)** Nail this corner with one 2" nail, before moving to the next step.





**(44)** Nail along the top, after making sure the siding is flush with the center of the double top plate as shown. Use an 8" to 12" nail spacing.



**(45)** Nail along the end, making sure siding is 1/2" out over the wall stud.



**(46)** Ensure that stud is parallel with siding, before nailing. Then firmly attach siding section along all edges and into each wall stud, using an 8" to 12" nail spacing.



**(47)** Put the next piece in place, flush with the previous piece, making sure the splice looks similar to the other grooves. Then fasten the corner of the siding to the plate.



**(48)** Nail along the top as done in previous piece.



**(49)** Nail along the splice, making sure the splice is parallel, and looks similar to the other grooves.



**(50)** Repeat previous steps for the rest of the siding.



**(51)** Snap a line, even with the edge of the wall frame, then move to next step.



**(52)** Set the saw to 1/2" and cut along the line so that it is flush with wall frame. **Repeat on opposite end.**

# Install Soffit



(53) Make a mark 3-3/4" down from top of siding. Repeat on opposite end.

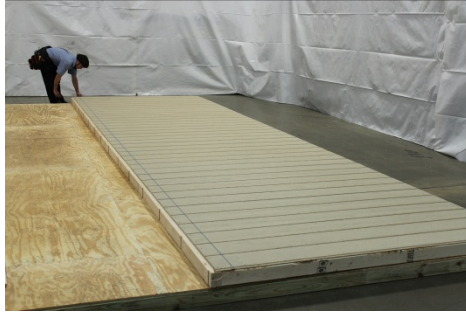

(54) Snap a line, using the marks from the previous step.



(55) Align bottom of 1x3 soffit strip with chalk line, and keep the end flush with wall frame, then secure, using 2" nails, and nailing on every stud.



(56) Repeat for the rest of the soffit strips, making sure the bottom of soffit strip is even with the line.



(57) Install soffit, starting on the right side of the wall, with the overlap edge sticking out 1/2" past the wall frame.



(58) Fasten the rest of the soffit much the same way as the siding. Last soffit piece should overhang by 1/2" as well. If necessary, cut to fit.

# Set Back Wall



(59) Set the wall, making sure edges of wall are flush with edges of floor. **Note: It is VERY important that a person holds the wall in place until wall is attached firmly to floor, or braced.**



(60) **INCORRECT!** Wall needs to be flush, and in against the floor frame, and down against the flooring.



(61) **CORRECT!** Move to next step.



**(62)** Fasten to floor, using two 3” screws at every stud, trying to hit the floor joists.



**(63)** Repeat for the rest of the wall, again; making sure wall is in against the floor frame.



**(64)** Attach bottom edge of siding to floor, using an 8” to 12” nail spacing. **Do not leave the back wall standing alone, without firmly bracing it.**

## Brace Back Wall



**(65)** Locate a rafter to use for bracing. Fasten the bottom, using two 3” screws.



**(66)** Make sure the wall is level, then fasten the brace to the wall.



**(67)** Repeat on opposite end.

## Assemble Front Wall Frame



**(68)** Locate and lay out the parts to assemble the front wall.

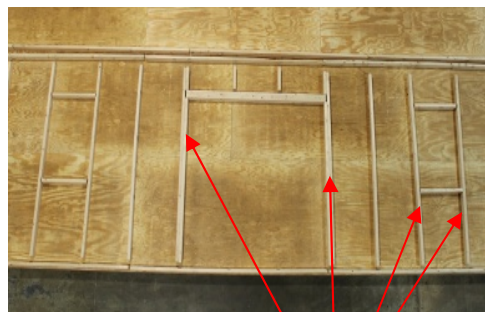

**(69)** Front wall is done much the same as the back wall except for the door and window studs. Locate double studs with dados for the door, and single studs with dados for the windows.



**(70)** Fasten window studs with dados, to the window blocks, using two 3” screws. Repeat for all the window studs.



**(71)** Fasten both door studs with dados, to the door header, using four 3" screws.



**(72)** Toe screw door header to door blocks, as shown.



**(73)** Fasten the rest of the studs, using the same method as the back wall.

## Install Front Wall Siding



**(74)** Lay out siding as shown here, with the over lap towards the right.



**(75)** Starting with the piece beside the door, place the siding even with the center of the double top plate, then make sure siding has 3/4" reveal along edge of door frame, before nailing.



**(76)** Nail the bottom, again; making sure siding has 3/4" reveal along edge of door frame, then finish nailing this piece.

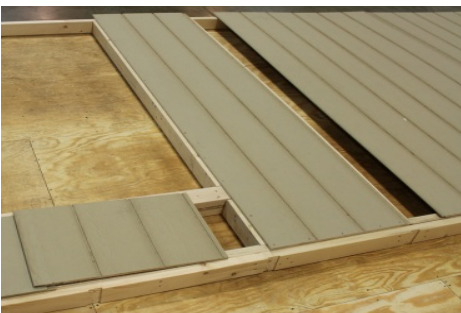

**(77)** Repeat for the other door piece.



**(78)** Fasten the siding pieces above the doors, and keep it 3/4" above door header as shown; before nailing.



**(79)** Finish nailing the rest of the siding pieces above the door.



**(80)** Before fastening the full pieces, check to see if the door opening is square. **IF NOT, pull the bottom of the wall left or right to adjust it, then fasten the rest of the pieces.**



**(81)** Cut the end of the siding, repeating steps **(51 and 52)** Then, install soffit, repeating steps **(53 to 58)**



**(82)** Fasten the front wall securely, repeating steps **(59 to 67)**

## Assemble Solid Gable Wall



**(83)** Locate and lay out the parts to assemble the gable wall with no garage door opening. **Note: Gable walls are inter-changeable. Place garage door opening on desired gable wall.** Top and bottom wall plates for the garage door have double dados for the door studs.



**(84)** Attach all wall studs to top and bottom and wall plates.



**(85)** Set the gable wall. **Note: You might need to remove a brace on one wall before setting the gable wall.**



**(86)** Fasten to floor, using 3" screws, every 12 to 14 inches, trying to hit the floor joist.



**(87)** Align gable wall framing flush with back wall framing and attach using 3" screws, every 12 to 14 inches.



**(88)** Repeat the process on front side.

# Assemble Gable Wall With Garage Door Opening



(89) Locate and lay out the parts to assemble the gable wall with garage door opening.

**Note: Gable walls are interchangeable. Place garage door opening on desired gable wall.**



(90) Attach all wall studs to top and bottom wall plate.

**Note: Top and bottom wall plates have double dados for the door studs.**



(91) Cut the bottom plate at garage door opening, using a sawzaw. Repeat on opposite end.



(92) Move the bottom plate cutout piece up to the top of door opening, and fasten securely, using 3" screws.



(93) Make a mark at 11-1/4" as shown.



(94) Fasten the garage door brace on the top and bottom, using the mark as a guide. Repeat for the other door brace.



(95) Set this gable wall. Door opening needs to be 9' wide. **Note: You might need to remove a brace on one wall before setting the gable wall.**



(96) Fasten the bottom plate to the floor.



(97) Align gable wall framing flush with back wall framing and attach using 3" screws, every 12 to 14 inches. Repeat on opposite side.

# Install Gable Wall Siding



**(98)** Locate and lay out the gable siding for the garage door gable, with overlap towards the front.



**(99)** Align siding flush with the top, and edge of front wall siding, using 2" siding nails.



**(100)** Nail siding along top edge, making sure the siding is parallel with the center of the double top plate.



**(101) Incorrect!** Ensure bottom corner of siding is properly aligned.



**(102) Correct!** Attach to wall studs, using 2" siding nails.



**(103)** Install the next siding piece. **Note:** Do not nail the siding along the bottom, at the garage door opening.



**(104)** Install the final piece, then move to next step.



**(105)** Lay out the siding for the opposite gable, again; making sure overlap is towards the front.



**(106)** Fasten the siding on this gable, starting on the front side.

# Cut Out For Windows and Garage Doors



(107) Run a 2" screw through siding at each corner of the window.

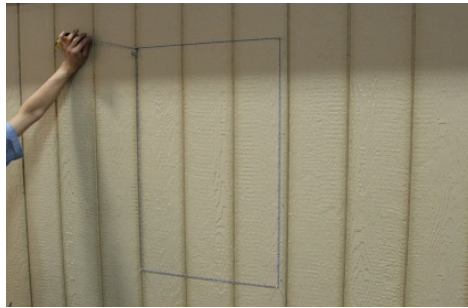

(108) Use the screws to snap a chalk line outlining window frame.



(109) Remove the screws and chalk line, then; set the saw at 1/2", and cut along the lines.



(110) Repeat for the other window, and also the garage door, using the same method.



(111) For the bottom of the garage door, where the circular saw can not access, use either the sawzaw or a chisel to cut the bottom.



(112) Done!



(113) Cut out bottom plate at the double door opening, using a sawzaw.



(114) Fasten two 2x4s to each other at the inside to inside width, to be used as a wall spacer, then move to next step.



(115) Move the 2x4 wall spacer to just below the top plate, and fasten it on both sides, making sure the walls are pulled in against the 2x4. **This will ensure that walls are properly spaced.**



# Assemble Rafters



(116) Ready for rafters!



(117) Lay out the rafter pieces and the gussets. **Note:** Two rafters will be assembled using only one rafter gusset, the remaining rafters will be assembled using two rafter gussets.



(118) Align the rafters as shown, then move to next step.

## Install Rafters



(119) Assemble each rafter by attaching one gusset to each side of the rafters as shown, using a total of ten 2" nails per gusset.



(120) Begin with end rafter keeping single gusset facing to interior of shed as shown.

**Important: One person needs to hold the rafter while another person fastens it.**



(121) Align rafter flush with edge of soffit, then screw soffit to rafter, using 2" screws. Repeat for opposite end of rafter.



(122) Screw rafter to top plate, using a 3" screw, making sure rafter is flush with the wall siding. Repeat for opposite end of rafter.



(123) Repeat these steps for the other gable rafter.



(124) Install the rest of the rafters, 24" on center, or in every dado groove on the top plate. Repeat, till all rafters are installed.

# Install Gable Peak Siding



(125) Toe screw all the rafters to top wall plate, making sure rafter is straight.



(126) Lay out the gable peak pieces as shown, with the over lap towards the front.



(127) Snap a chalk line 1/4" below the bottom of the soffit as shown. **Note:** The peak pieces in the front will be sticking down past the garage door opening. Once installed, cut it back flush with the frame, using the same method as before.



(128) Install the piece towards the front first, making sure it is aligned with the rafter and the chalk line. **Note: Grooves in gable siding should align with grooves in wall siding, as shown in next step.**



(129) **Correct!** Fasten firmly with 2" siding nails.



(130) Repeat with the rest of the peak pieces, making sure the bottom is flush with the chalk line. **Repeat the process on the other gable, again; making sure overlap is towards the front.**

# Install Gable Overhangs



(131) Starting with the left gable overhang, put the overhang in place, then refer to the next step before fastening.

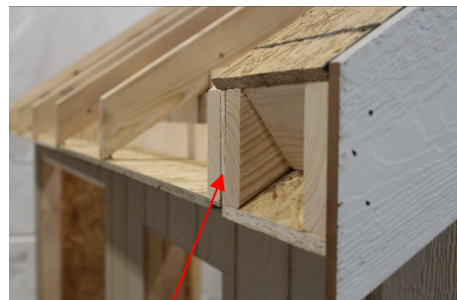

(132) Make sure the gable overhang is flush with the rafter, and tight in against the gable siding, as shown.



(133) Fasten gable overhang to rafter, using 2" screws, every 8 to 12 inches.



**(134)** Fasten the top as shown.



**(135)** Install right gable overhang, repeating previous steps.



**(136) Incorrect!** Before fastening the overhangs on the top, make sure the splice is uniform, as shown in next step.



**(137) Correct!** Fasten firmly, using a 3" screw.



**(138)** Repeat previous steps for opposite gable.



**(139)** Properly secure gable overhangs with 3" screws, every 10 to 12 inches.



**(140)** Locate the 4 gable braces then fasten them at the siding splices in the peak, using 3" screws.



**(141)** Fasten the bottom of the gable brace on both sides.



**(142)** Fasten the other gable brace on this gable, then repeat for opposite gable. Next, fasten the siding splices to the gable braces on the outside.

# Install Roof Sheathing



(143) Locate the roof sheathing, and scatter it out, starting with a full 4'x8' piece on the right side.



(144) Starting from the end, make a mark every 24".



(145) Starting with the right piece, push roof sheathing tight against the gable overhang, and align flush with bottom edge of gable rafter, then attach, using a 2" nail.



(146) Make sure sheathing is centered on rafter, then attach at bottom left corner. **Important! Nail along the bottom at every rafter, before moving to next step.**



(147) Fasten the bottom right corner of the next piece of roof sheathing, making sure the edges are aligned perfectly. Then repeat previous steps for the next pieces.



(148) Fasten the last piece of sheathing, making sure it is flush with bottom edge of gable rafter. **Important! Nail along the bottom, at every rafter before moving to next step!**

## Use Extreme Caution When Climbing On Roof!



(149) Pull gable overhang parallel with the roof sheathing, then attach along gable rafter, using 2" nails every 8 to 12 inches.



(150) Adjust the rafters to align with the marks you had made in step (144), then fasten the top of the roof sheathing to rafters. Finally, nail the rest of the roofing, using an 8 to 12 inch nail spacing.



(151) Lay out and fasten the top row sheathing, making sure the splices are alternated.

# Install Front And Back Fascia



(152) Repeat previous steps for the back side.

**Note: If the marks on the sheathing do not align properly with the rafters, you will need to lift a corner of the building, to adjust it.**



(153) Hold the fascia in place, making sure it is centered with the rafter, then move to next step before nailing.



(154) Make a mark flush with the gable fascia, then cut to length.



(155) Fasten to rafters, using two 2" trim nails per rafter, and making sure fascia is flush with the top of the rafters, and with the gable fascia.



(156) Repeat previous steps, **making sure the splice is tight against the other piece as shown, before cutting to length and fastening.**



(157) Repeat previous steps for the fascia on the back side.



(158) Make a mark, flush with the fascia on the bottom as shown, then refer to next step.



(159) Cut along the mark as shown.



(160) Completed! Repeat on the other three corners.

**Note: This is the best time to paint the shed; before the windows, shingles, doors, corner trim, and vents are on.**

# Install Windows, Trim, And Vents



**(161)** Caulk around the perimeter of the window, and in every groove along the top, before moving to next step.



**(162)** Install window, making sure it is straight, then fasten it, using three 2" screws per side.

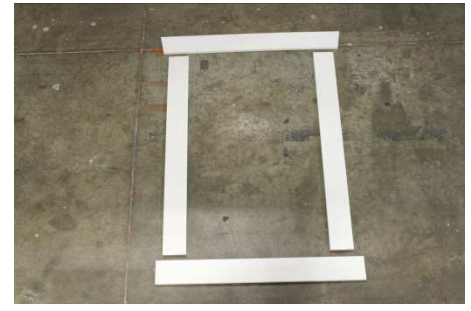

**(163)** Lay out the trim for the window.



**(164)** Align side trim piece along the lines on the window frame as shown and attach using 2" trim nails. Repeat for the left trim piece.



**(165)** Install the rest of the trim pieces as shown. Repeat for the other window.



**(166)** Install vents, caulking around the perimeter, before installing.



**(167)** Install the vent, making sure it is straight, then fasten, using two 1-1/4" screws per side. Repeat for the other vent on opposite gable.

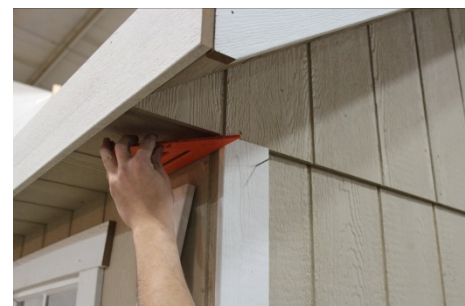

**(168)** Attach corner trim to gable wall, making sure it is flush with the front wall as shown, using 2" trim nails spaced 8-12" apart, along edge of trim.

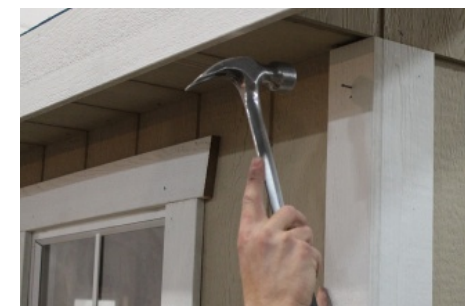

**(169)** Install the other corner pieces as shown. Repeat for the rest of the corners.

# Install Door Trim And Shutters



**(170)** Align trim flush with edge of siding and attach, using two - 2" trim nails spaced every 12 to 14 inches.



**(171)** Repeat for the other side, making sure the trim to trim opening is 72" before nailing. Check the measurement on the middle and bottom as well.



**(172)** Fasten the top piece, making sure you divide it out evenly across the top.



**(173)** Install diamond plate as shown, using two 2" nails every 10 to 12 inches.



**(174)** Nail poly strip just below the diamond plate, using 2" trim nails and dividing it out evenly from left to right, ect.



**(175)** Install shutters, using six white screws per shutter. Repeat for other window.

# Install Garage Door Pack-outs



**(176)** Install the short garage door pack-out as shown, making sure it is flush with the frame, using 2" nails. Repeat for opposite side.



**(177)** Install the side garage door pack-out, making sure it is flush with the frame. Repeat for opposite side.



**(178)** Fasten the inside garage door pack-out as shown, making sure it is flush with outside pack-out.. Repeat on opposite side.

# Install Garage Door Trim



**(179)** Fasten the top pack-out, again; making sure you keep it flush with outside pack-out.



**(180)** Fasten the short pack-out as shown. Repeat on opposite side.



**(181)** Fasten the left side trim piece as shown, using 2" trim nails. Repeat on right side.



**(182)** Install short trim piece. Repeat on opposite side.



**(183)** Install top trim piece, dividing it out evenly. If necessary; cut the piece to ensure a proper fit.



**(184)** Completed!

# Install Doors



**(185)** Position the doors where you want them.



**(186)** Find the hardware bag and locate the following.

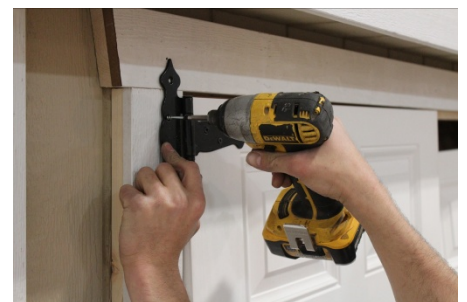

**(187)** Start with the left door, and fasten to trim using 2-1/2" black screws, and making sure you keep the top of the door down from the trim, approximately 1/4".





**(188)** Fasten the other hinges, keeping door flush with the trim on the left side.



**(189)** Repeat for the right door, again, making sure you keep the top of the door down from the trim, approximately 1/4" as shown.



**(190)** Finish fastening the rest of the hinges, using previous steps.



**(191)** Pull door in, tight against the frame, then make a mark for the inside latch pin. Repeat on the bottom.



**(192)** Drill a hole, with 5/16" drill bit, using the pre-made marks.

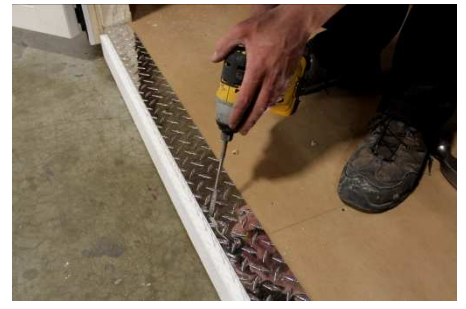

**(193)** Repeat on the bottom.



**(194)** Install latch using 2" black screws.



**(195)** Attach L-handle as shown using a 5/32 Allan Wrench. Adjust as needed.

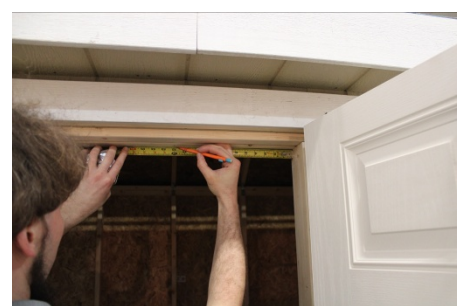

**(196)** Make a mark at 12", then install door spring, as shown in next step.

# Interior

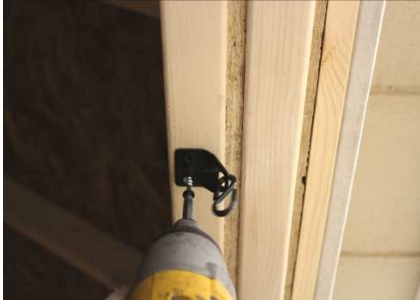

(197) Install the door spring fastener, using two 1-1/4" black screws.



(198) Fasten the other section of the spring to the door, using two 1-1/4" black screws.



(199) Fasten the cross-ties, using 3" screws. **Note: Divide the cross-ties out equally.** Then remove the wall spacer that was installed in step (114-115)



(200) Install hurricane ties, using 1-1/4" screws.



(201) Correct!



(202) Repeat for all the other rafters, on both the front and back.

# Assemble Ramp

(Skip the ramp steps if you did not get a floor with the package)



(203) Lay out the ramp pieces, if you got a floor with this unit.  
**Note: You will need to cut one 6' board in half for the cross pieces.**



(204) Attach cross piece 12" up from end of ramp.

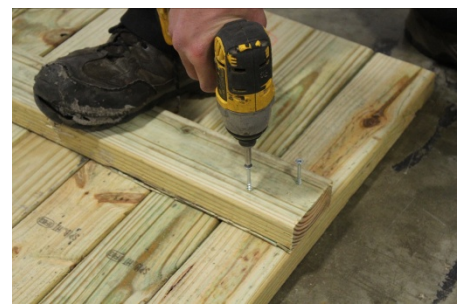

(205) Attach crosspieces to ramp boards, using two 2" screws per board. Countersink the screws approximately 1/4"  
**Repeat this method for the opposite end of the ramp.**

# Install Drip Edge



(206) Position ramp.



(207) Keep drip edge flush with the gable as shown, then nail every 12 to 14 inches, using roofing nails. **(Nails not included.)** Repeat for the next piece, keeping flush with the other gable.



(208) Overlap the gable piece over the bottom piece and nail only the bottom.



(209) Make a mark on the drip edge, parallel with the gable splice.



(210) Cut along the mark.



(211) Bend around the top as shown. This top piece should overlap the bottom piece. Do not fasten it till the bottom piece is installed on the other side. Finish installing the rest of the drip edge.



## Center Alignment (Stud & Siding Layout)

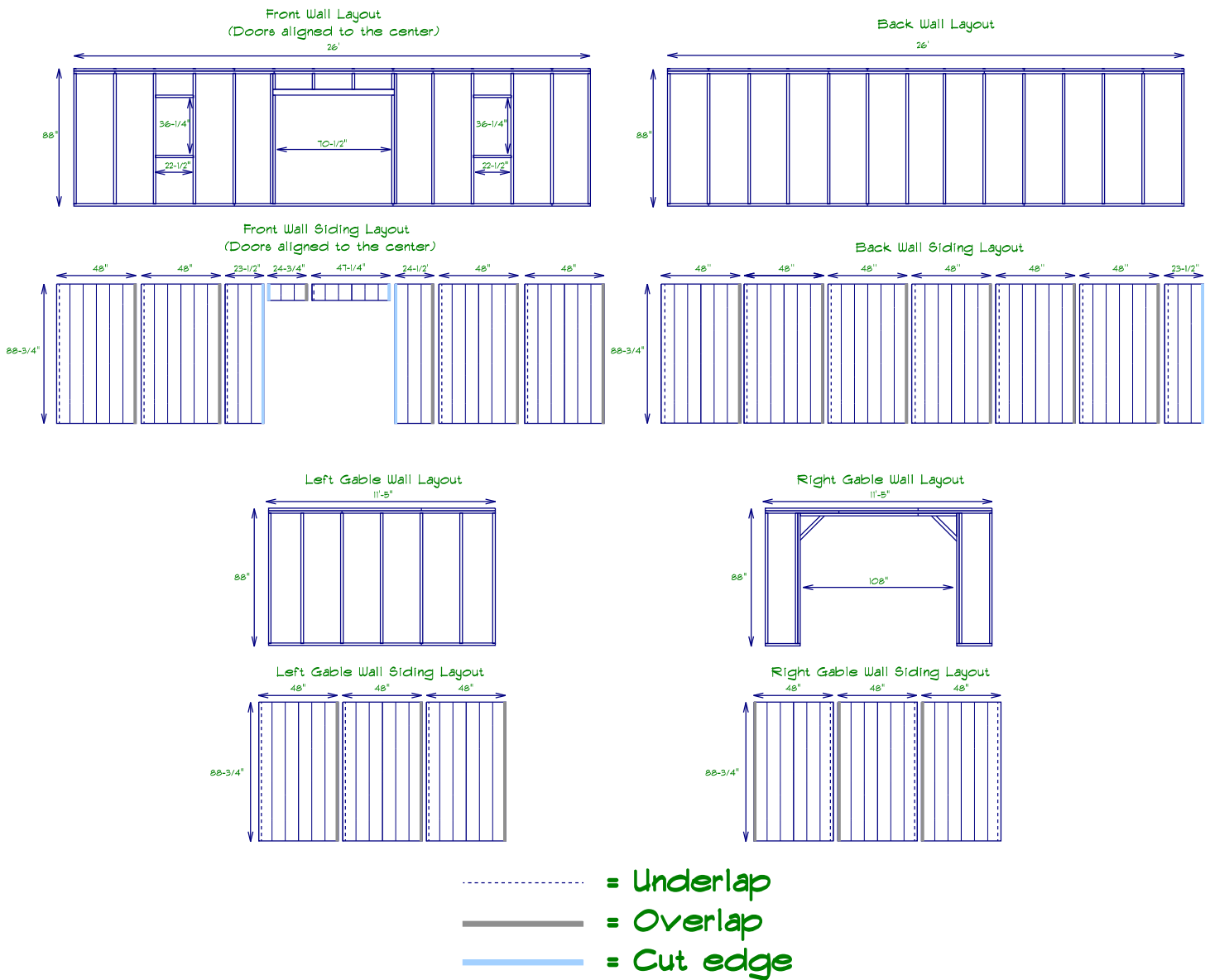

For The Gable Siding, ALWAYS Start With The Overlap Towards The Front

## Stud & Siding Wall Layout (4-Sides)

SCALE: 1/8" = 1'-0"

Front Wall Layout  
(Doors aligned to the center)  
26'

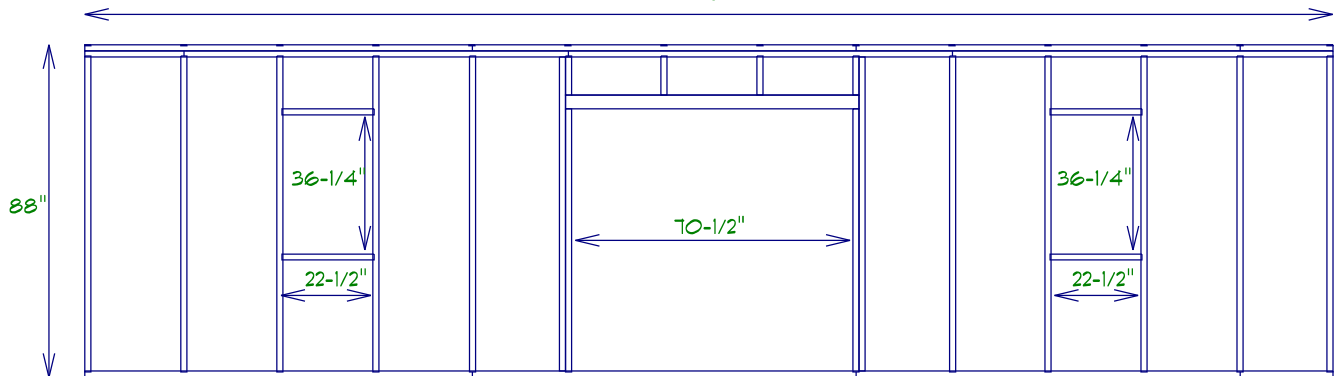

Front Wall Siding Layout  
(Doors aligned to the center)

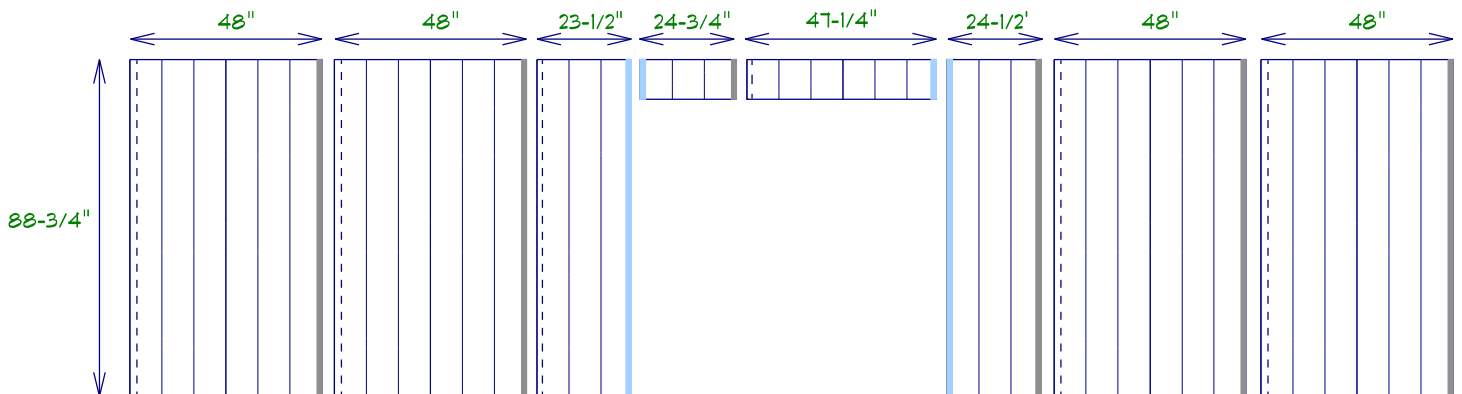

- - - - - = Underlap
- = Overlap
- = Cut edge

Front Wall Layout

SCALE: 1/4" = 1'-0"

### Back Wall Layout

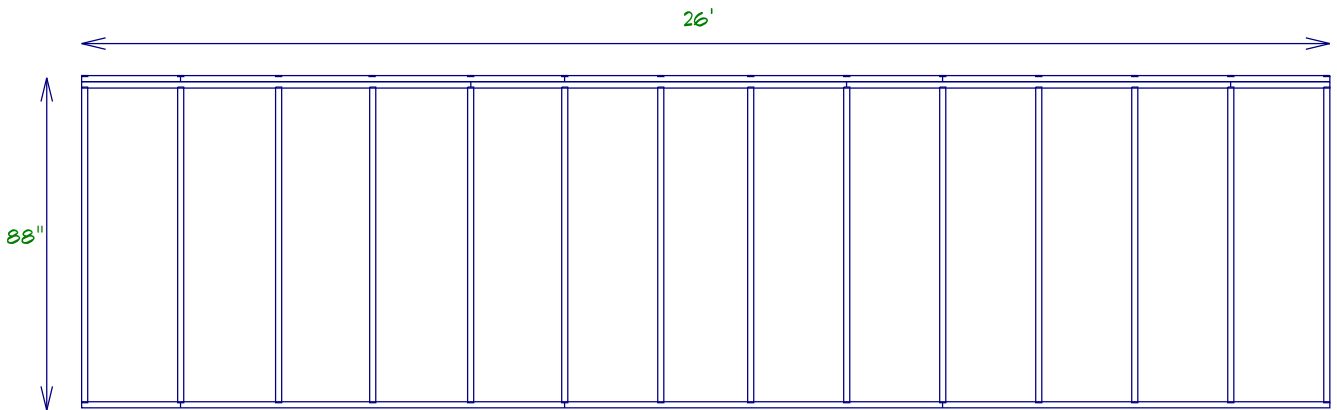

### Back Wall Siding Layout

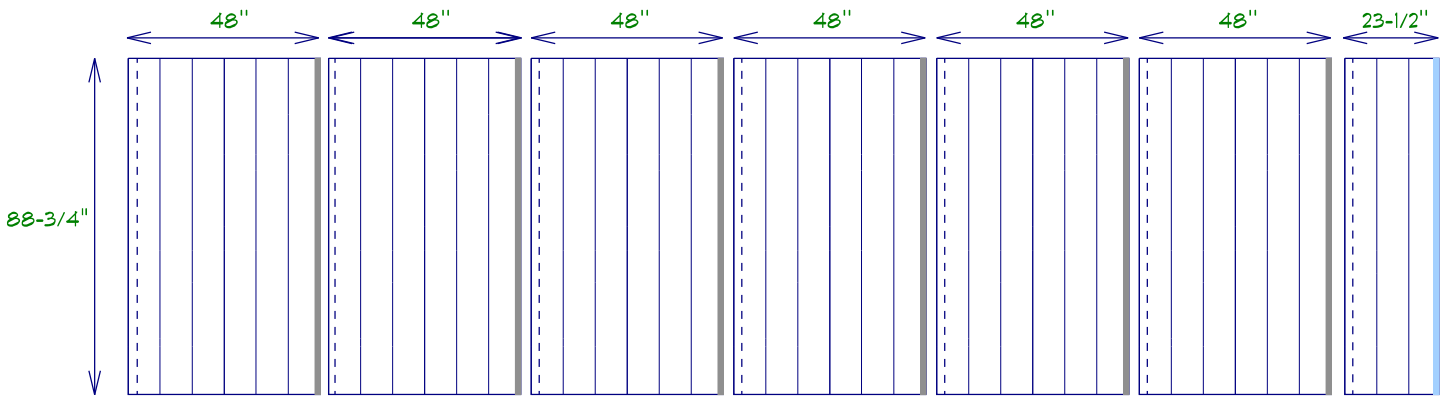

- - - - - = Underlap
- = Overlap
- = Cut edge

## Back Wall Layout

SCALE: 1/4" = 1'-0"

## Left Gable Wall Layout

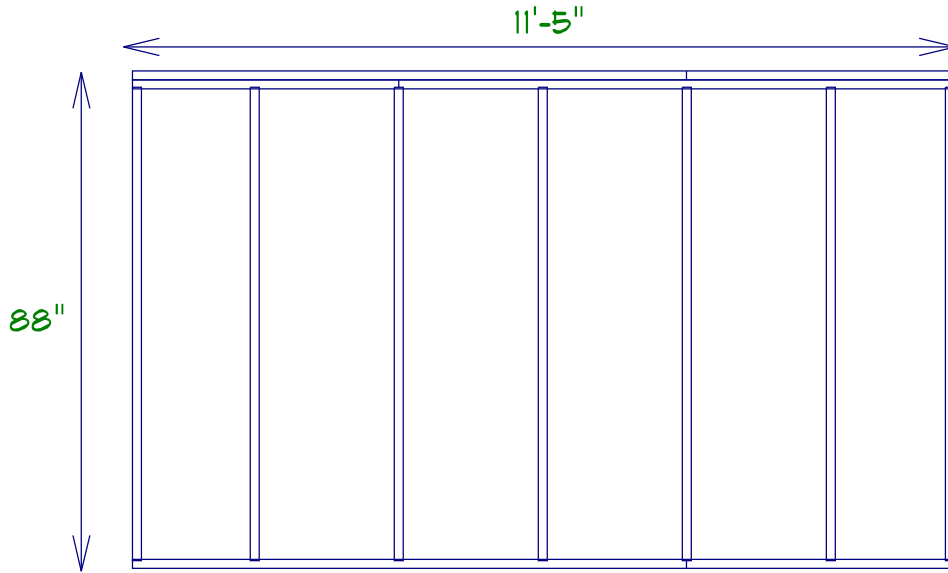

## Left Gable Wall Siding Layout

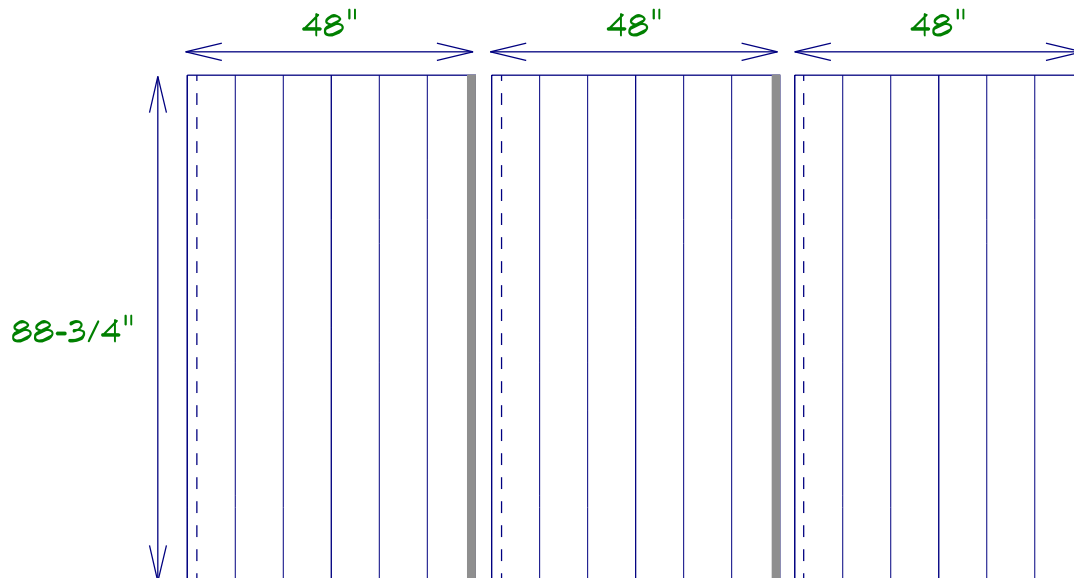

- - - - - = Underlap
- = Overlap
- = Cut edge

## Left Gable Wall Layout

SCALE: 3/8" = 1'-0"

## Right Gable Wall Layout

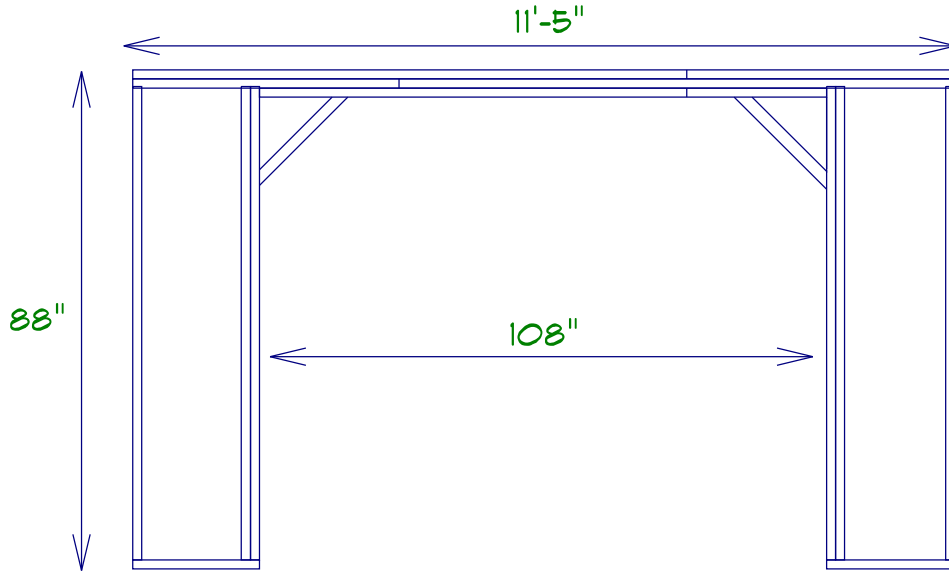

## Right Gable Wall Siding Layout

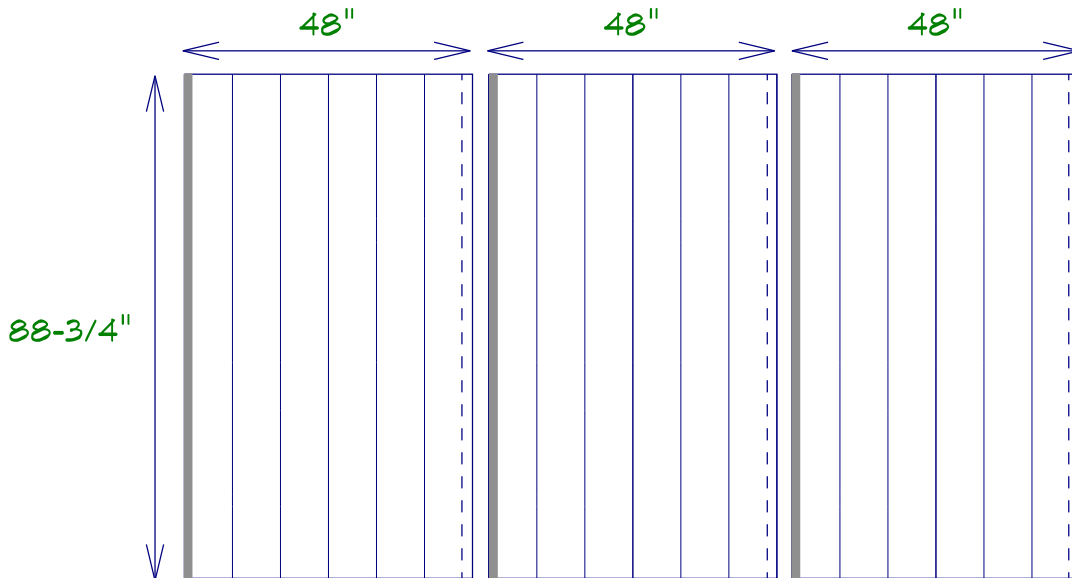

- = Underlap
- = Overlap
- = Cut edge

## Right Gable Wall Layout

SCALE: 3/8" = 1'-0"



# (Left Gable) Peak Siding Layout

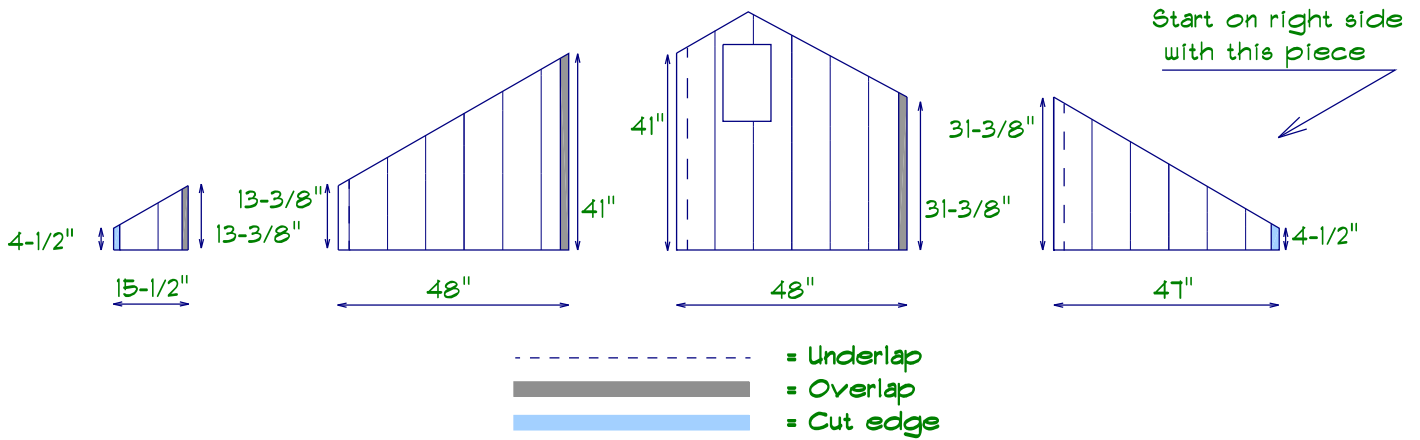

# (Right Gable) Peak Siding Layout

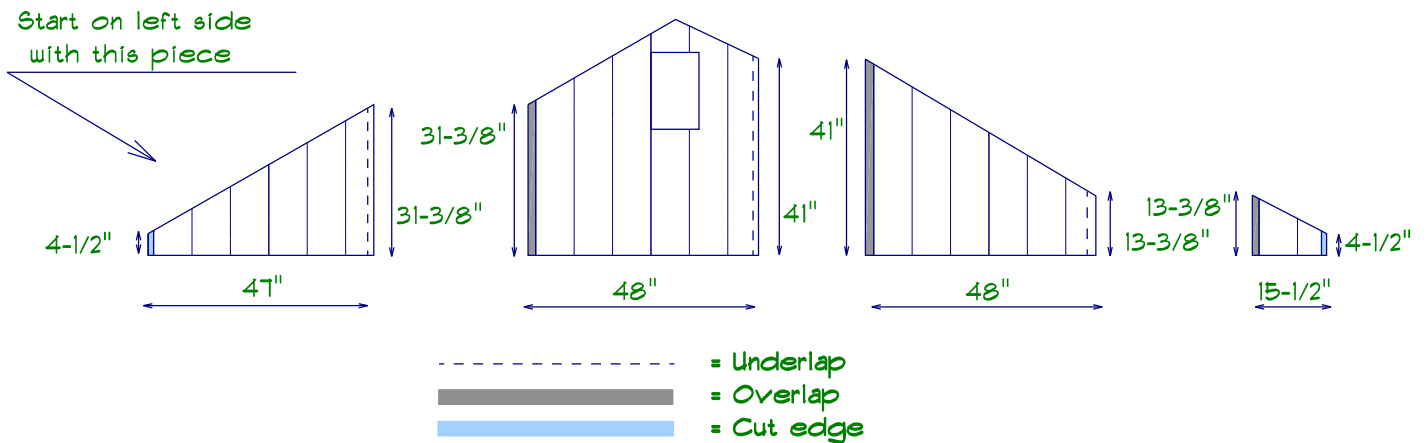

## Gable Peak Siding Layout

SCALE: 0.3000" = 1'-0"

## Left Alignment (Stud & Siding Layout)

Front Wall Layout  
(Doors aligned to the left)

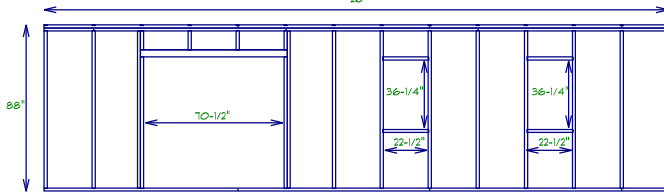

Back Wall Layout

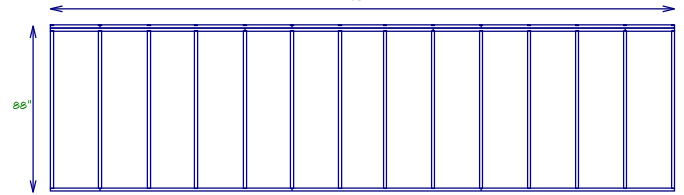

Front Wall Siding Layout  
(Doors aligned to the left)

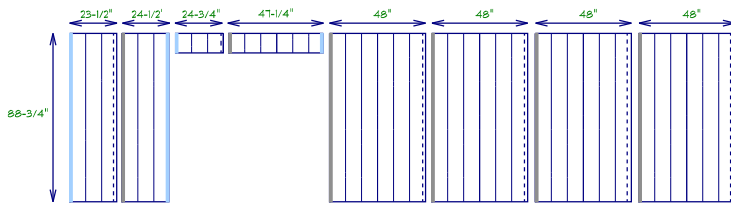

Back Wall Siding Layout

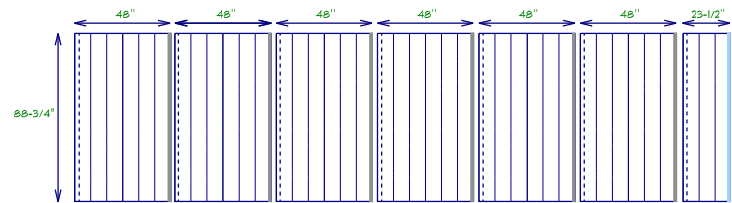

Left Gable Wall Layout

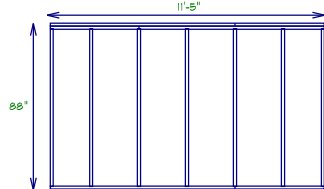

Right Gable Wall Layout

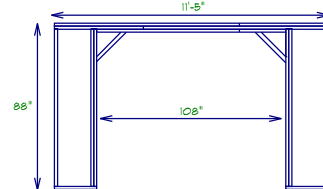

Left Gable Wall Siding Layout

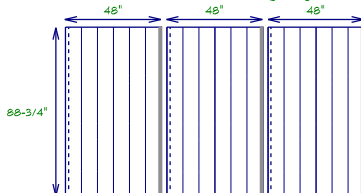

Right Gable Wall Siding Layout

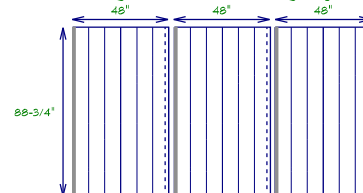

- = Underlap
- = Overlap
- = Cut edge

For The Gable Siding, ALWAYS Start With The Overlap Towards The Front

## Stud & Siding Wall Layout (4-Sides)

SCALE: 1/8" = 1'-0"

Front Wall Layout  
(Doors aligned to the left)

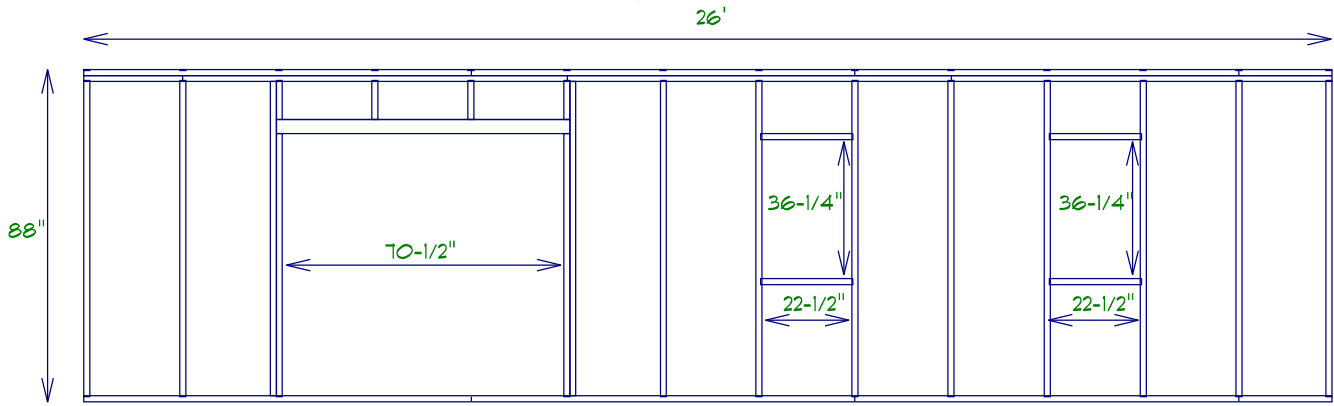

Front Wall Siding Layout  
(Doors aligned to the left)

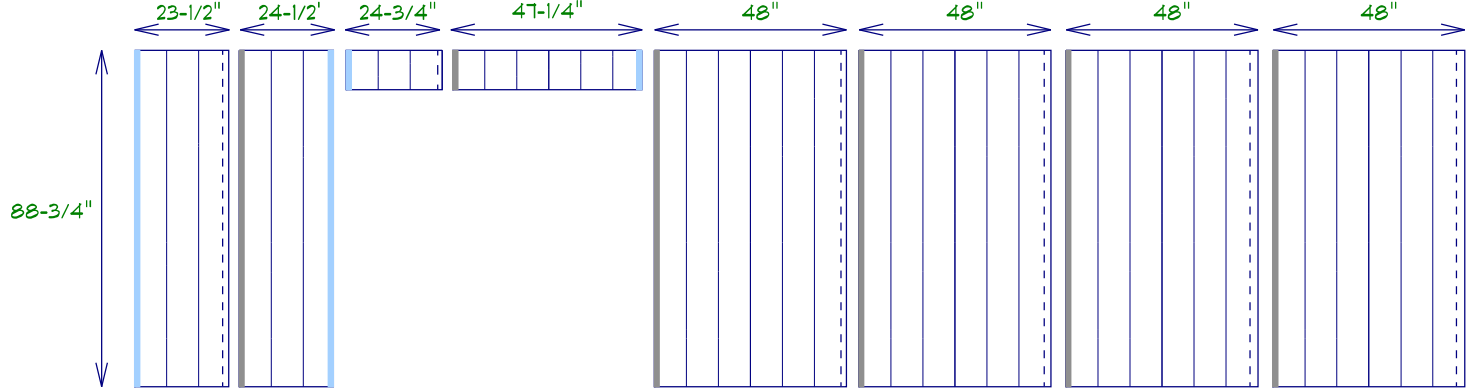

- = Underlap
- = Overlap
- = Cut edge

Front Wall Layout

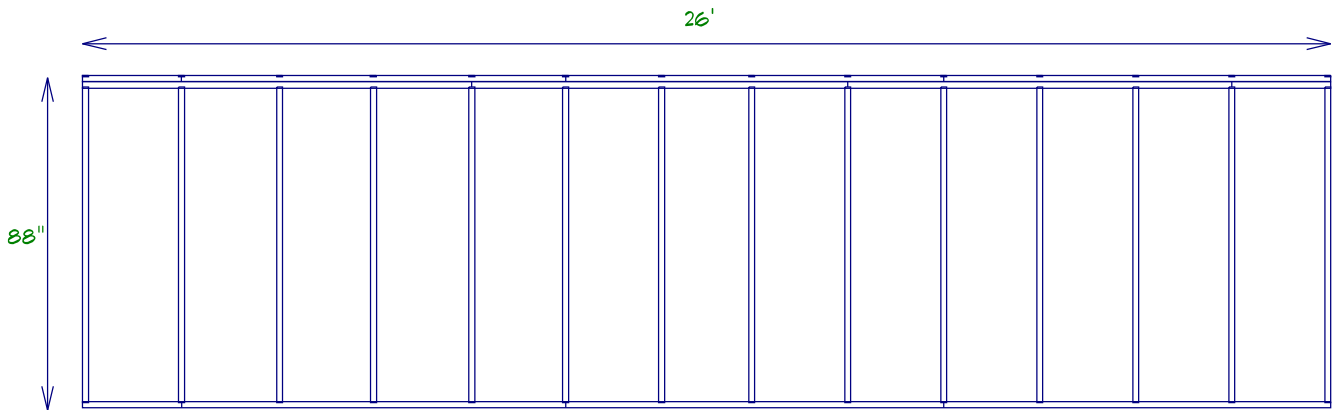

SCALE: 1/4" = 1'-0"

### Back Wall Layout

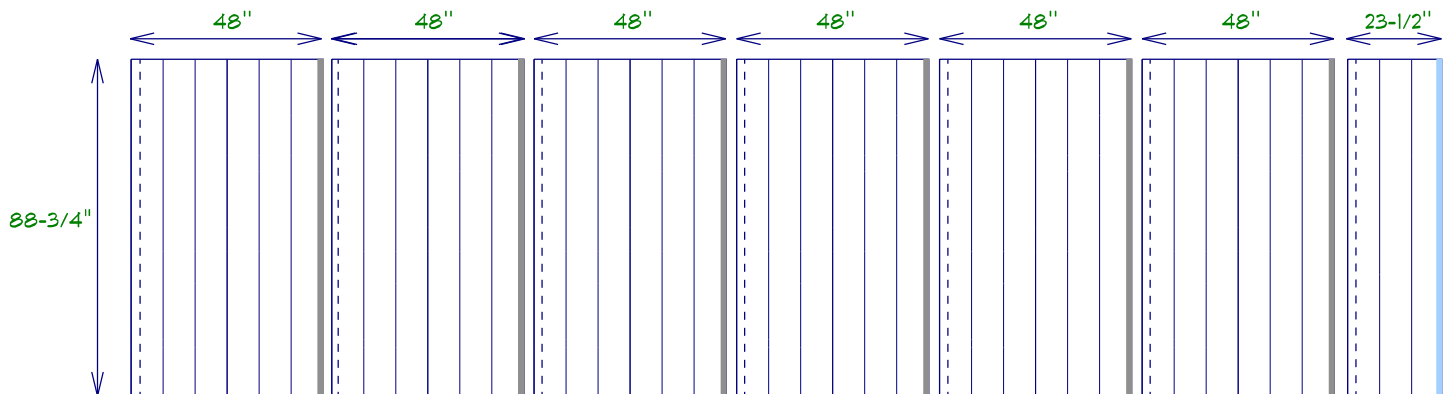

### Back Wall Siding Layout



-  = Underlap
-  = Overlap
-  = Cut edge

## Back Wall Layout

SCALE: 1/4" = 1'-0"

## Left Gable Wall Layout

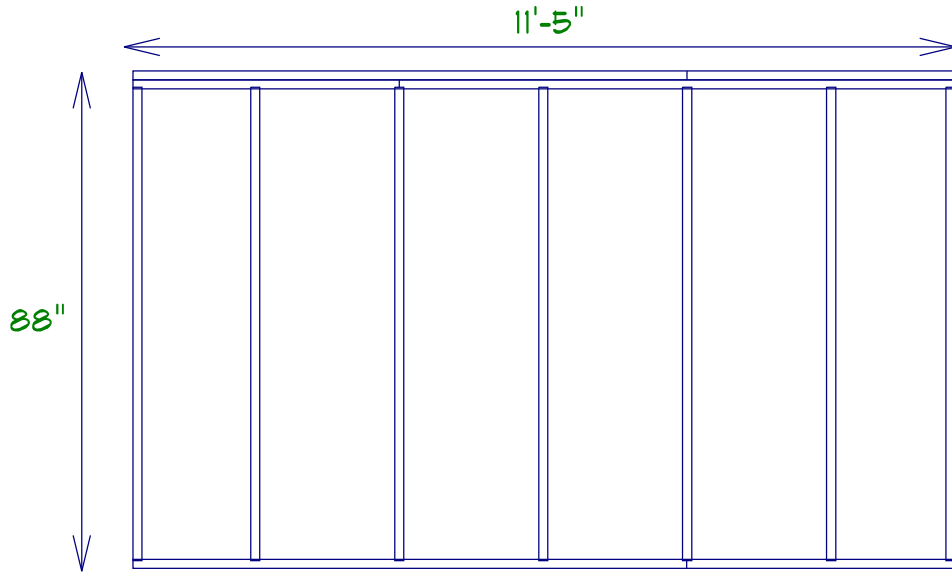

## Left Gable Wall Siding Layout

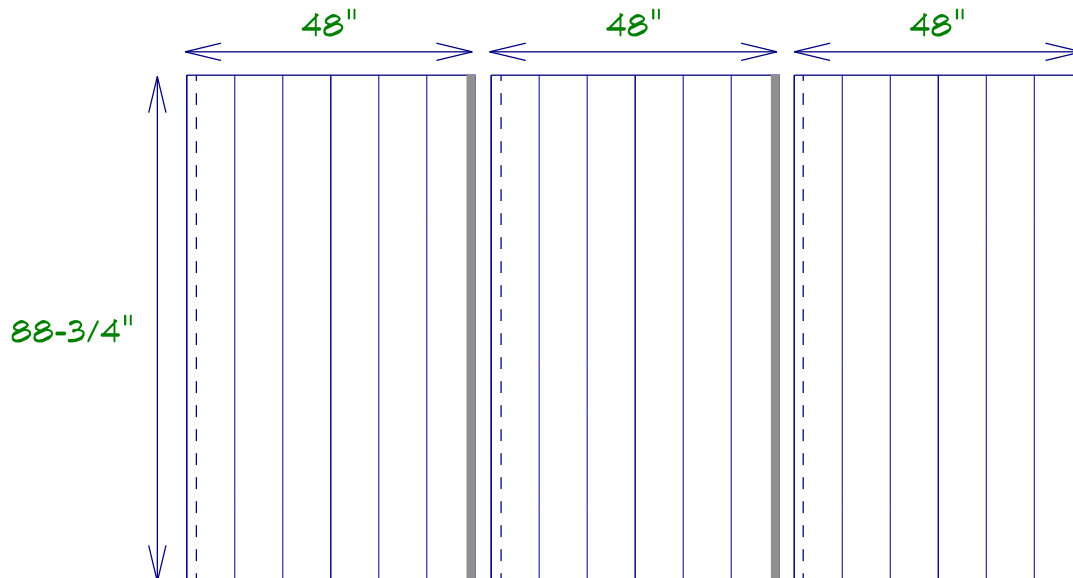

- - - - - = Underlap
- = Overlap
- = Cut edge

## Left Gable Wall Layout

SCALE: 3/8" = 1'-0"

## Right Gable Wall Layout

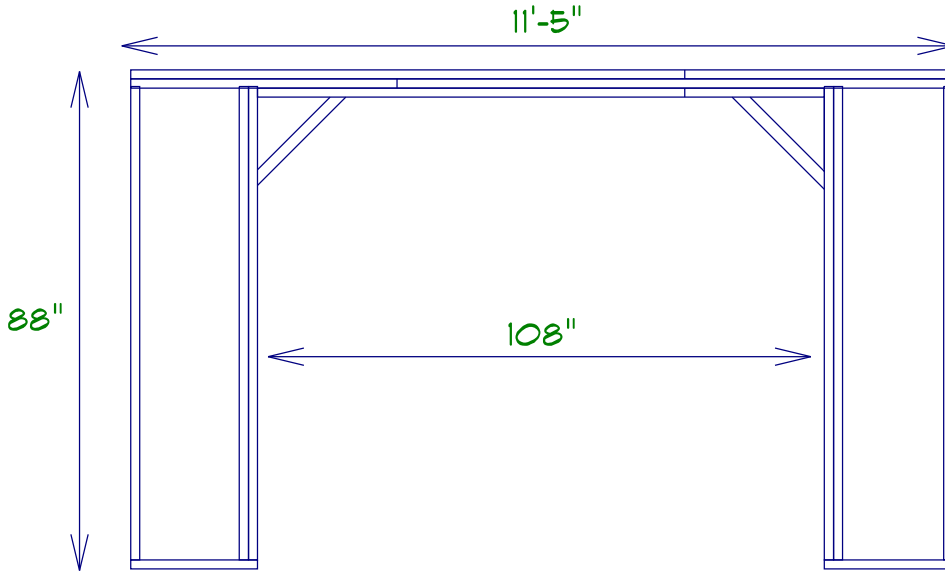

## Right Gable Wall Siding Layout

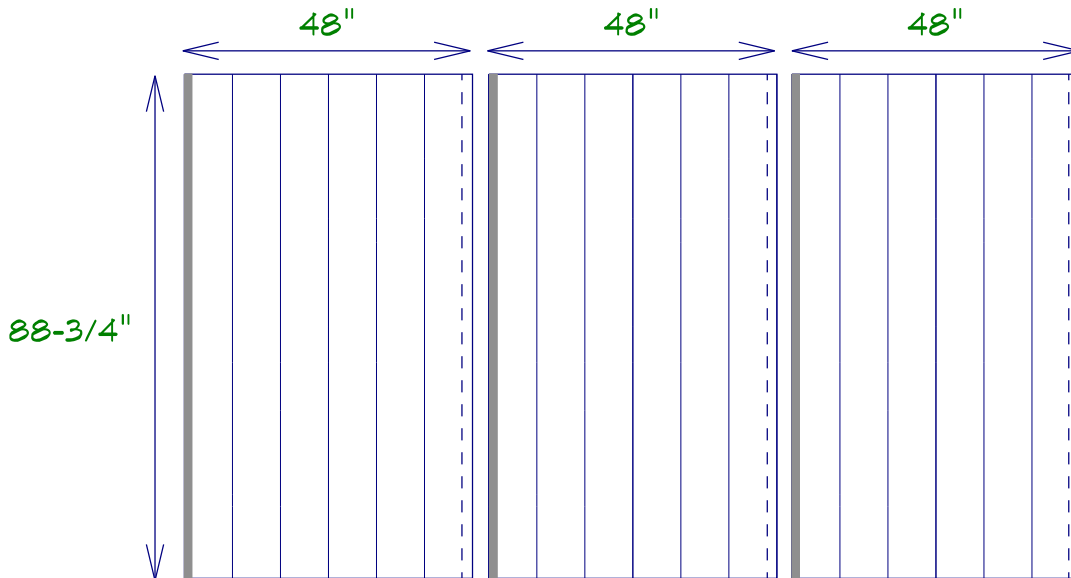

- - - - - = Underlap
- = Overlap
- = Cut edge

## Right Gable Wall Layout

SCALE: 3/8" = 1'-0"

# (Left Gable) Peak Siding Layout

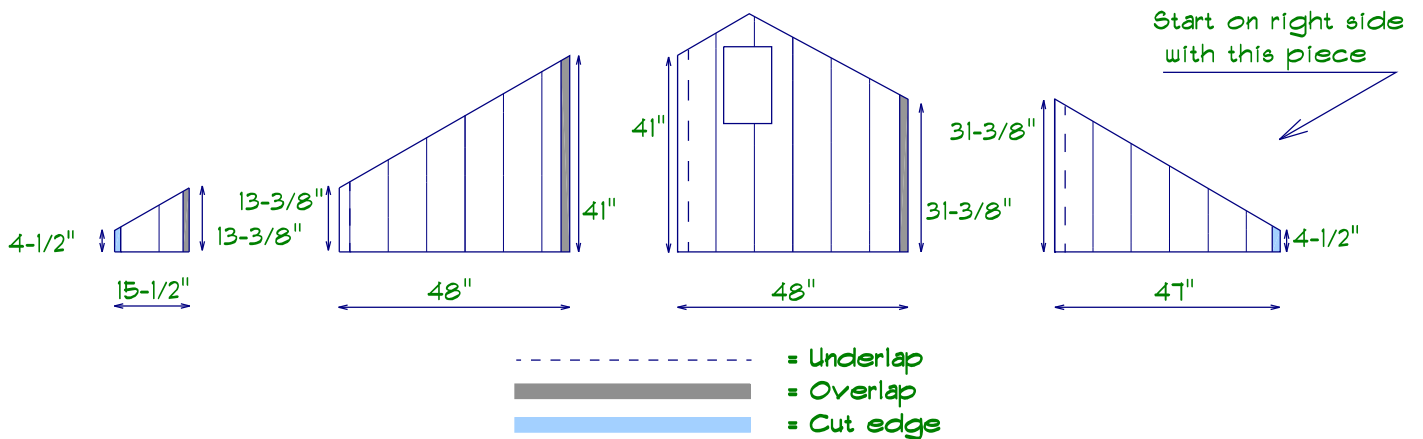

# (Right Gable) Peak Siding Layout

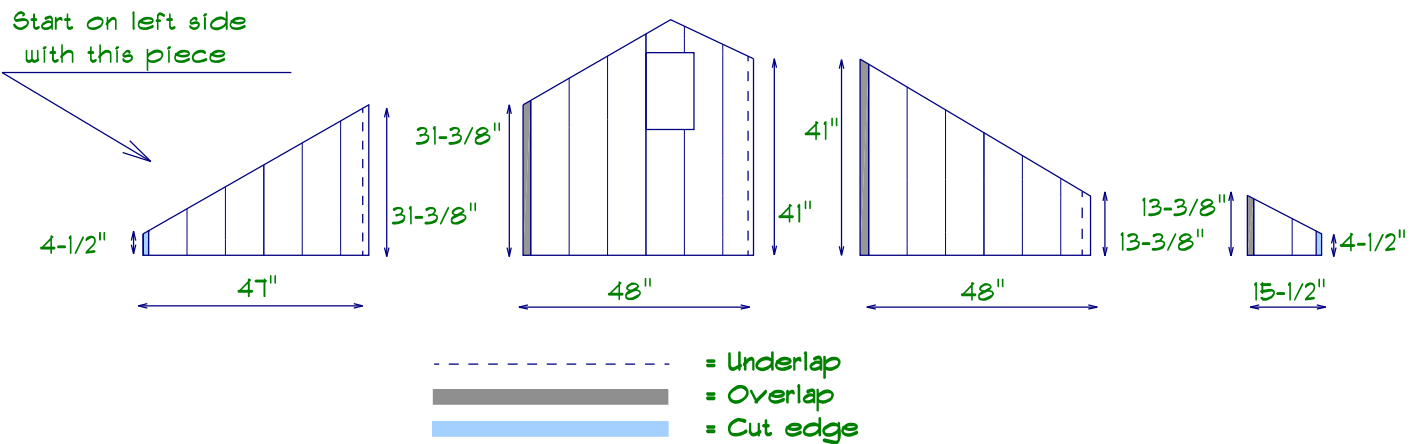

## Gable Peak Siding Layout

SCALE: 0.3000" = 1'-0"

## Right Alignment (Stud & Siding Layout)

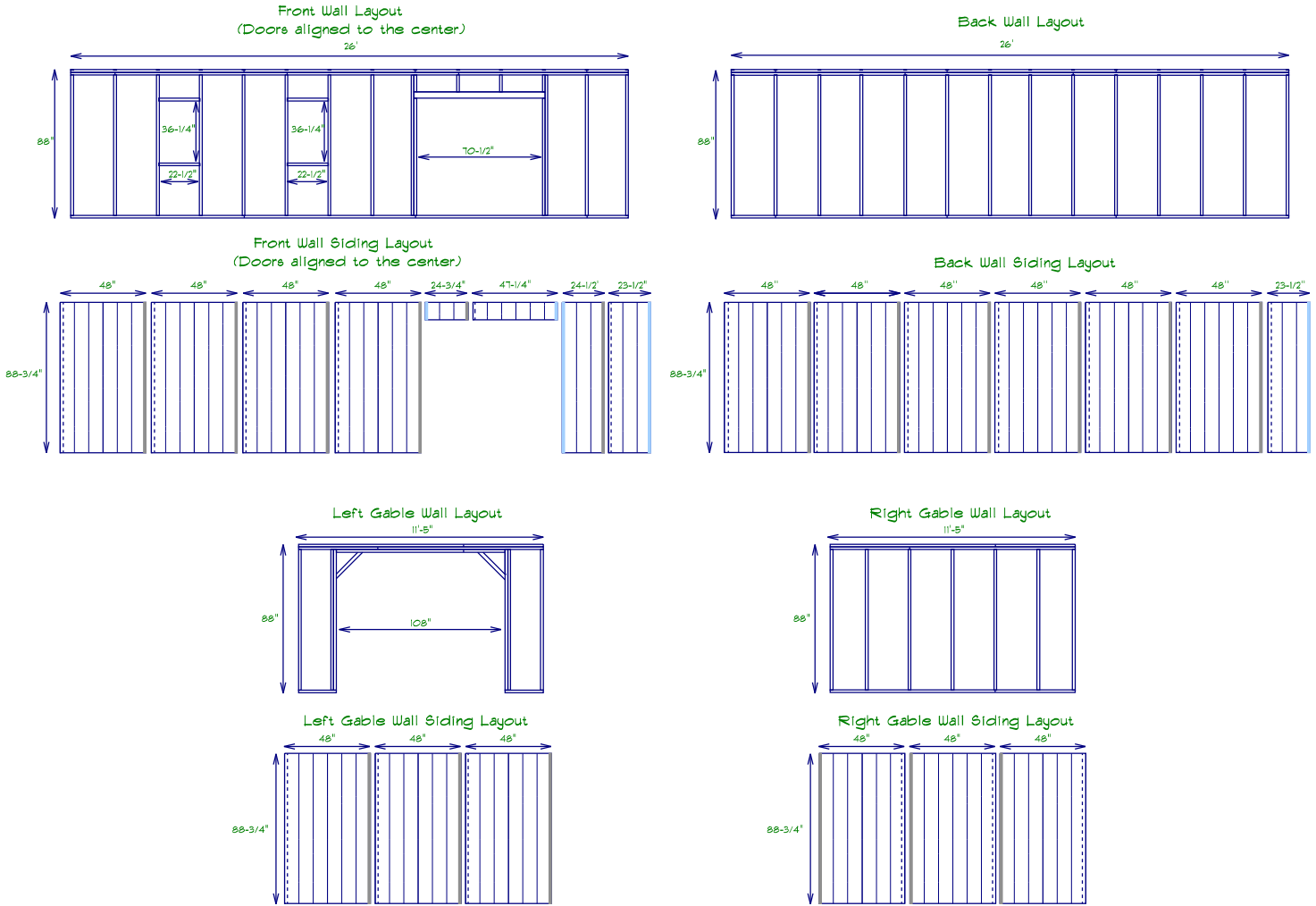

- = Underlap
- = Overlap
- = Cut edge

For The Gable Siding, ALWAYS Start With The Overlap Towards The Front

## Stud & Siding Wall Layout (4-Sides)

SCALE: 1/8" = 1'-0"



Front Wall Layout  
(Doors aligned to the right)

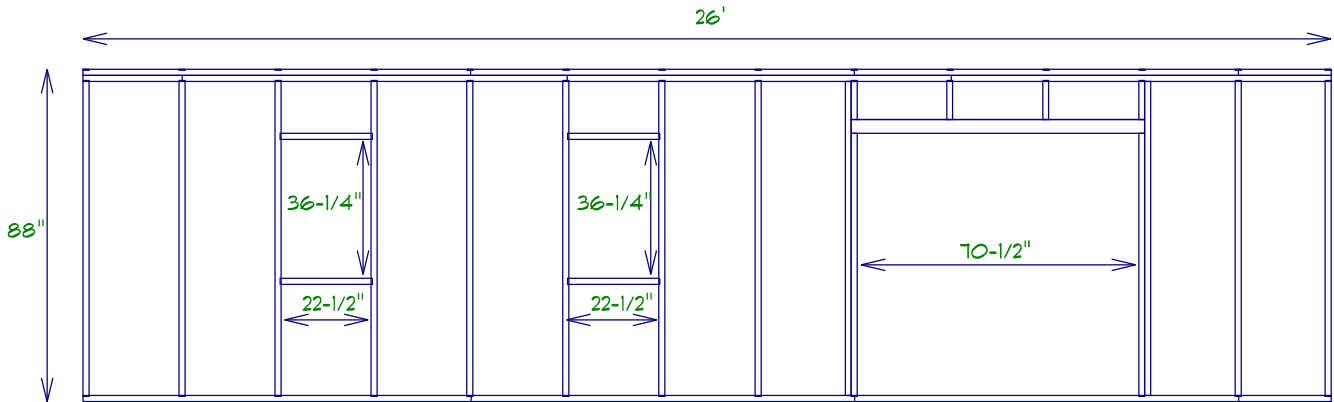

Front Wall Siding Layout  
(Doors aligned to the right)

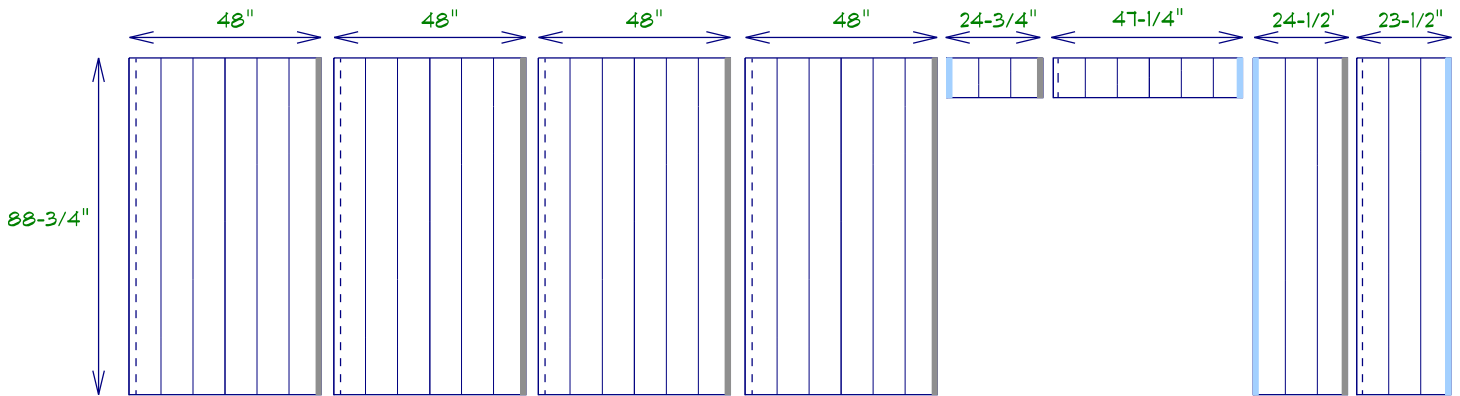

- - - - - = Underlap
- = Overlap
- = Cut edge

Front Wall Layout

SCALE: 1/4" = 1'-0"

## Back Wall Layout

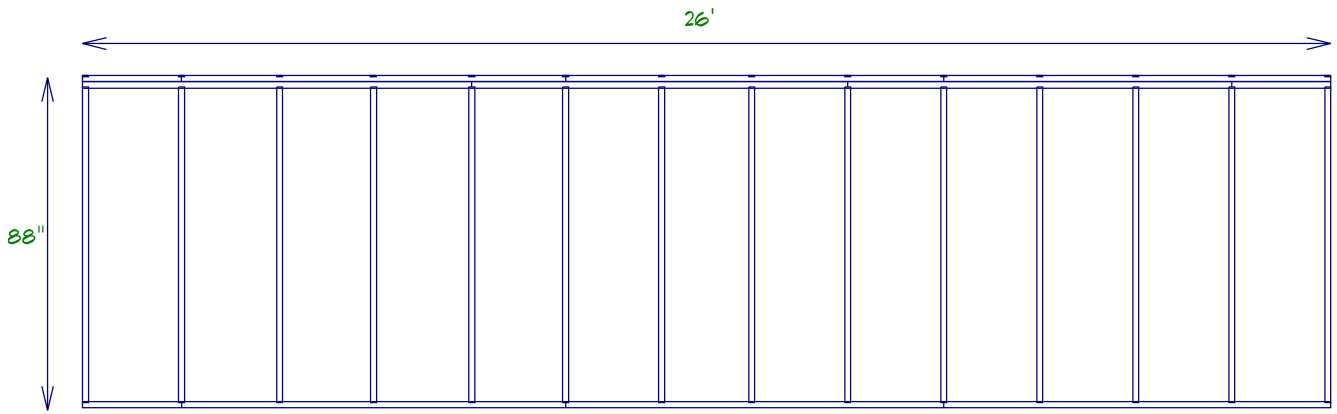

## Back Wall Siding Layout

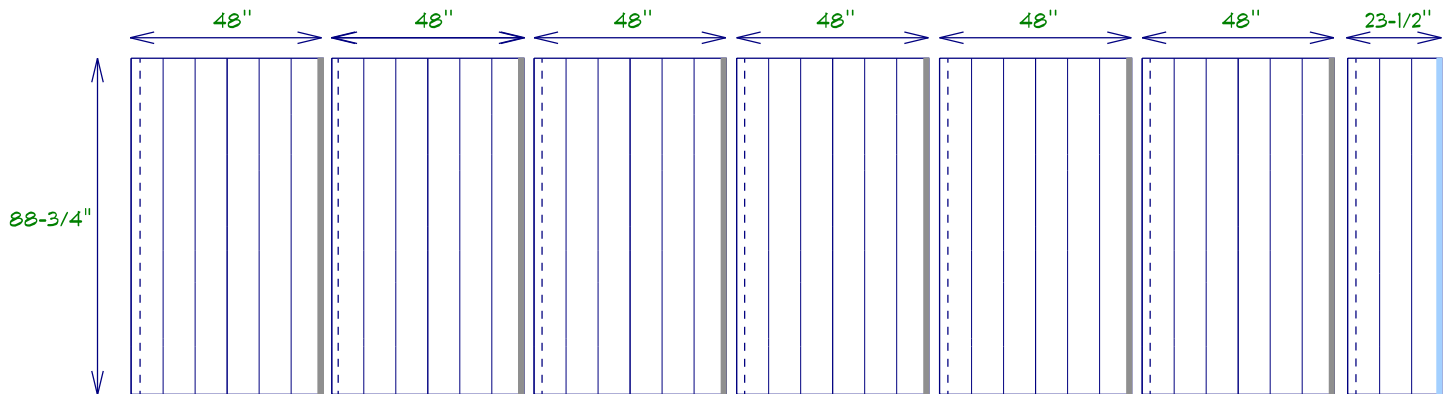

- - - - - = Underlap
- = Overlap
- = Cut edge

## Back Wall Layout

SCALE: 1/4" = 1'-0"

## Left Gable Wall Layout

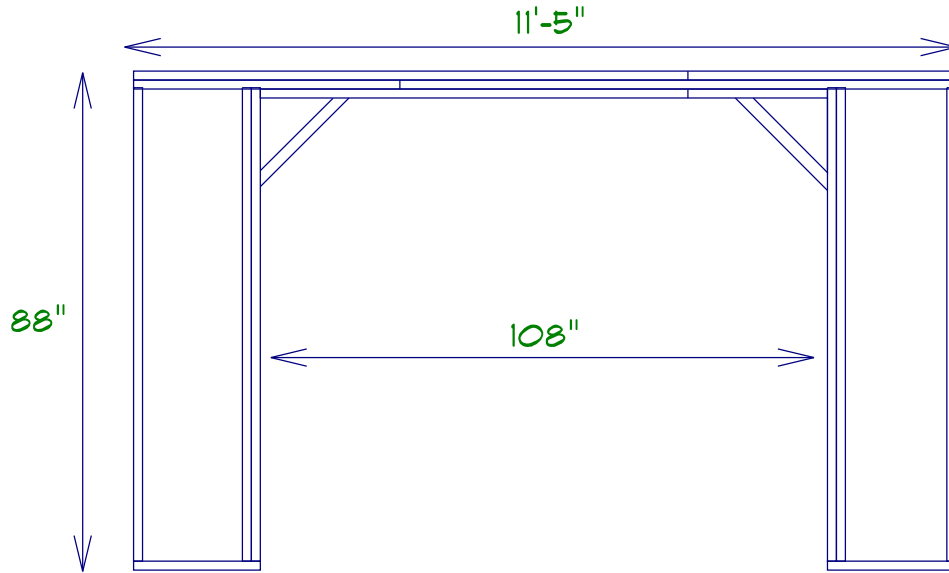

## Left Gable Wall Siding Layout

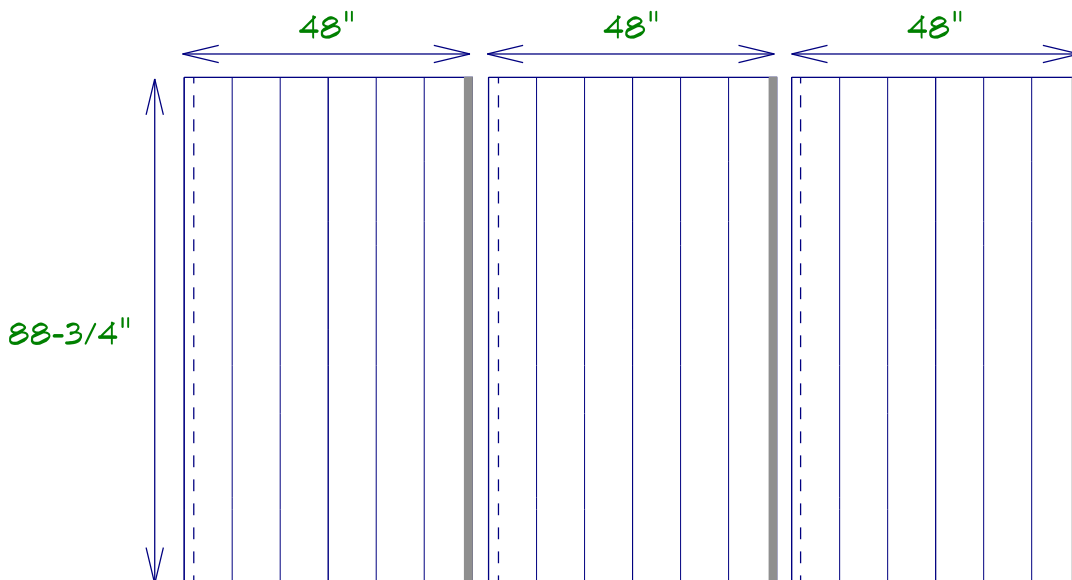

= Underlap



= Overlap



= Cut edge

## Left Gable Layout

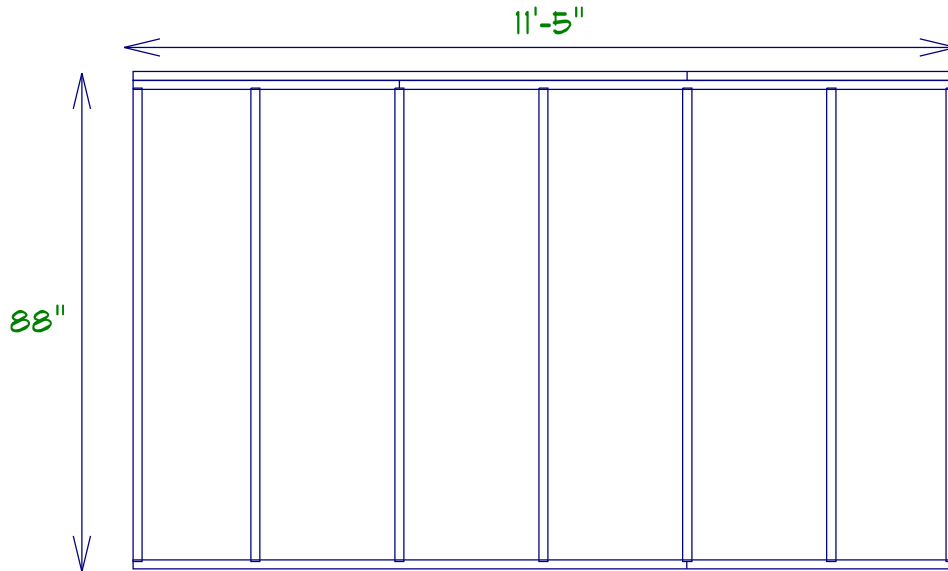

SCALE: 3/8" = 1'-0"

## Right Gable Wall Layout

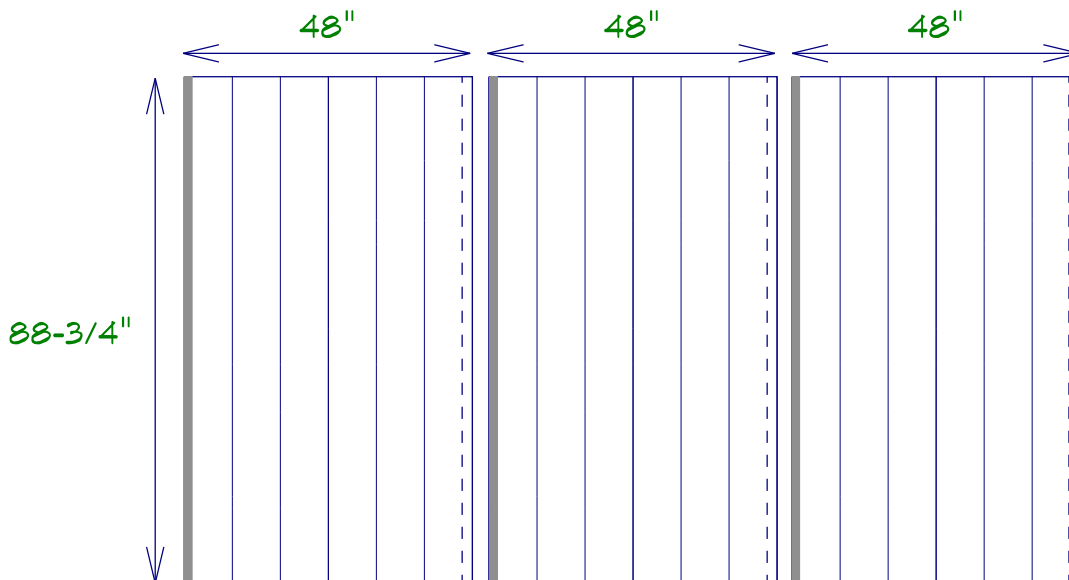

## Right Gable Wall Siding Layout



-  = Underlap
-  = Overlap
-  = Cut edge

## Right Gable Layout

SCALE: 3/8" = 1'-0"

# (Left Gable) Peak Siding Layout

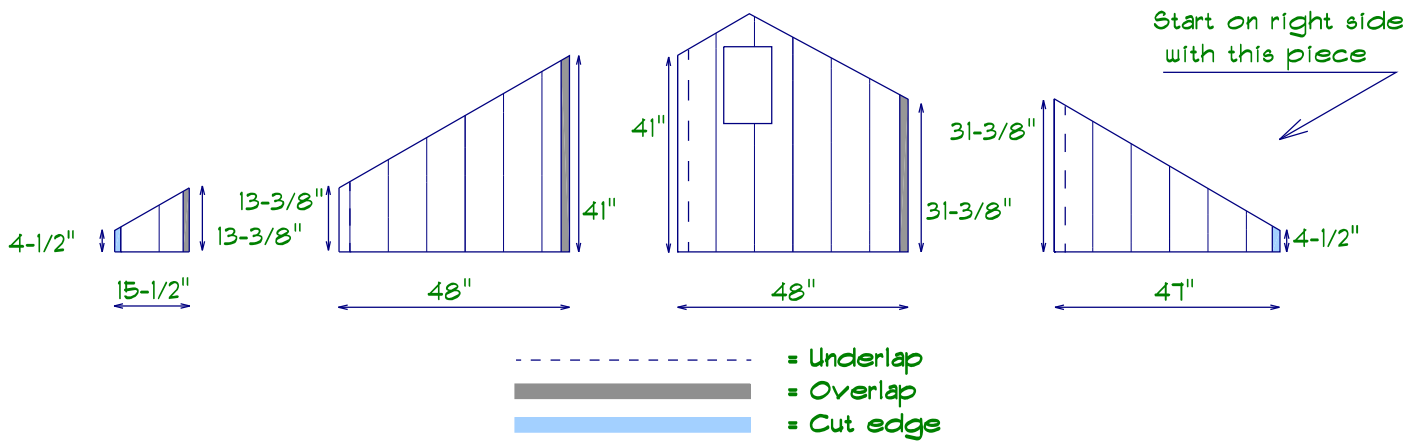

# (Right Gable) Peak Siding Layout

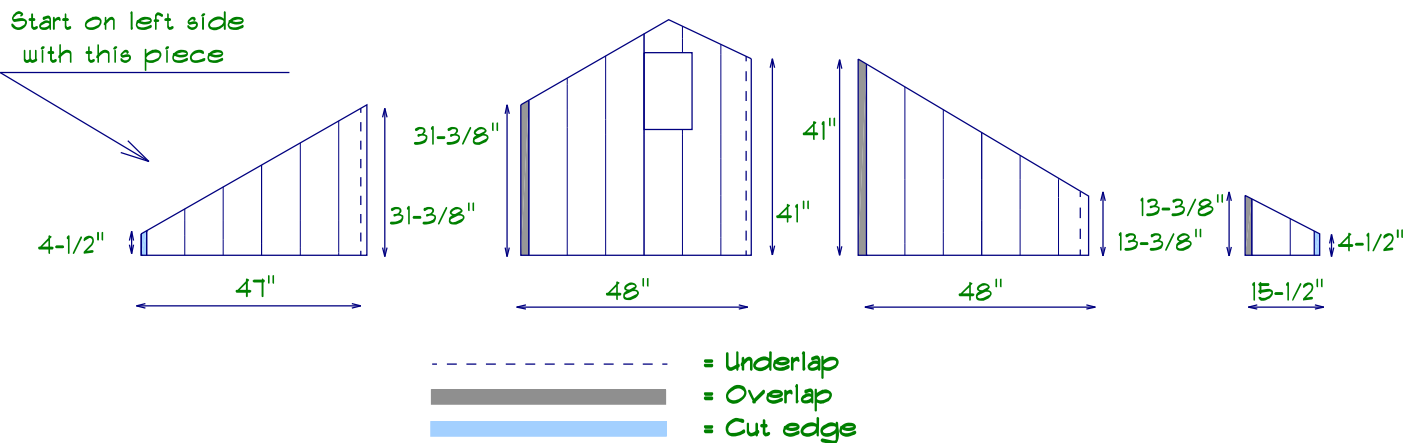

## Gable Peak Siding Layout

SCALE: 0.3000" = 1'-0"