



VIVA

INSTRUMENTS

Surgical Instruments Catalogue

www.vivainstruments.co.uk



*Manufacturer & Exporter of Premium Quality
Surgical Instruments
Fully Certified Manufacturing Since 1980*



Percussion Hammers and Aesthesiometers
 Reflexhammer und Sensibilitätsinstrumente



01-101
 TROEMNER
 Size: 245 mm



01-102
 DEJERINE
 Size: 200 mm



01-103
 DEJERINE
 with needle
 Size: 210 mm



01-104
 TAYLOR
 Size: 195 mm



01-107
 RABINER
 with needle
 and brush
 Size: 255 mm



01-105
 BERLINER
 Size: 200 mm



01-106
 BUCK
 with needle
 and brush
 Size: 180 mm



01-108
 ALY
 Size: 190 mm



01-109
 WARTENBERG
 Pinwheel for
 neurological
 examination
 Size: 185 mm



01-110
PINARD (Aluminum)
Size: 155 mm

1/2



01-111
wooden
Size: 145 mm

1/2



01-112
BOWLES
Stethoscope
with diaphragm

1/4



01-113
ANESTOPHON

1/2



01-114
FORD-BOWLES
Dual chest piece
with two outlets

1/4



01-115
BOWLES

1/4

Head Mirrors and Head Bands Reflexspiegel und Stirnbänder



01-116
ZIEGLER Ø 90mm
head mirror only
with rubber coating



01-117
ZIEGLER Ø 90mm
head mirror only
with metal coating



01-118
ZIEGLER
head band of plastic black

01-119
ZIEGLER
head band of plastic white



01-120
MURPHY
head band of celluloid, white



01-121
head band of plastic,
white, soft pattern



01-122
head mirror with black
plastic head band.

Tongue Depressors Zungenspatel

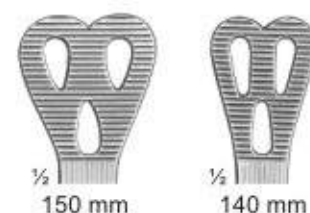
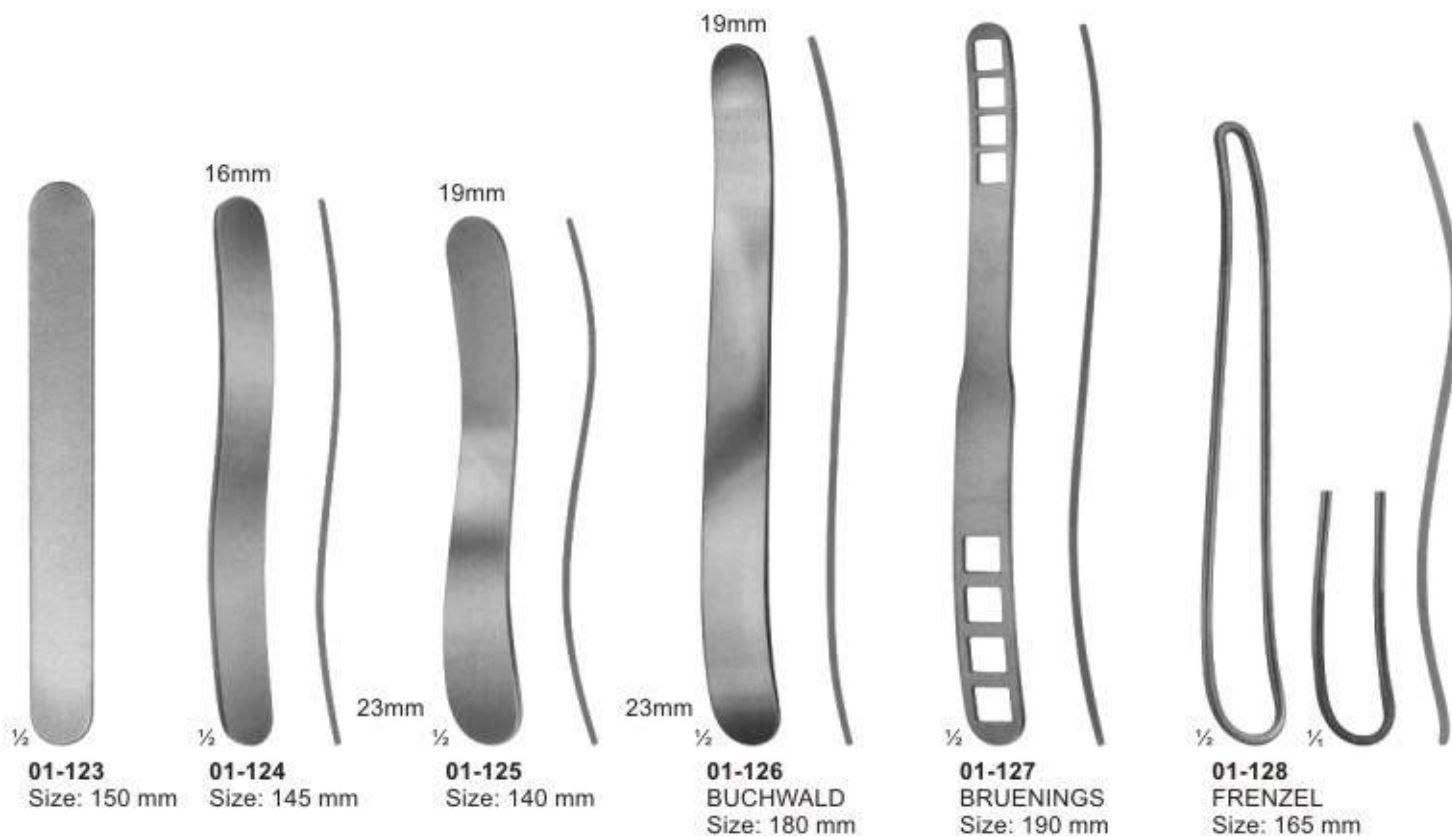



½
01-134
SCHIMMELBUSCH
 Ether mask



½
01-135
HEISTER
 Mouth gag
 Size: 130 mm



½
01-136
FERGUSSON-ACKLAND
 Mouth gag
 Size: 145 mm



½
01-137
DENHARDT
 Mouth gag with silicon
 inserts, interchangeable
 Size: 125 mm



½
01-138
ROSER KOENIG
 Mouth gag
 Size: 160 mm, 185 mm

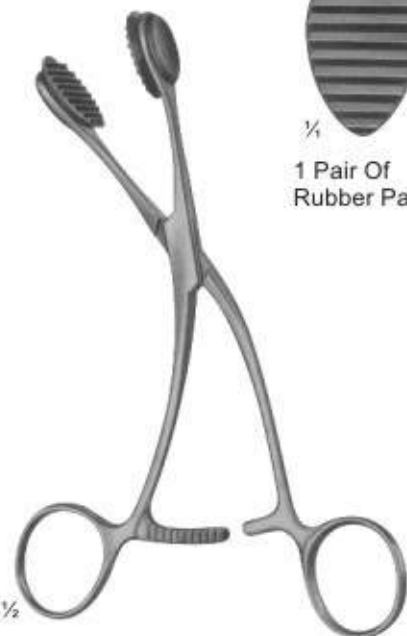

½
 1 Pair Of
 Rubber Pads

½
01-139
YOUNG
 Size: 165 mm

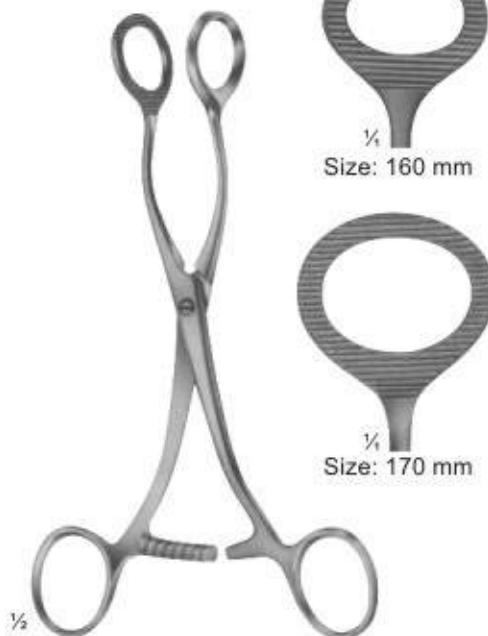

¼
 Size: 160 mm

¼
 Size: 170 mm

½
01-140
COLLIN
 Size: 160 mm, 170 mm

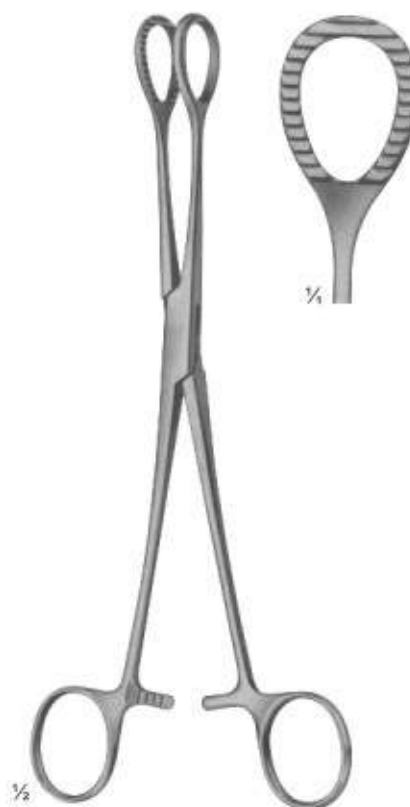

½
01-141
HEYWOOD-SMITH modif.
 Size: 215 mm

Blood Lancets and Laryngeal Mirrors Blutentnahmenadeln und Kehlkopfspiegel

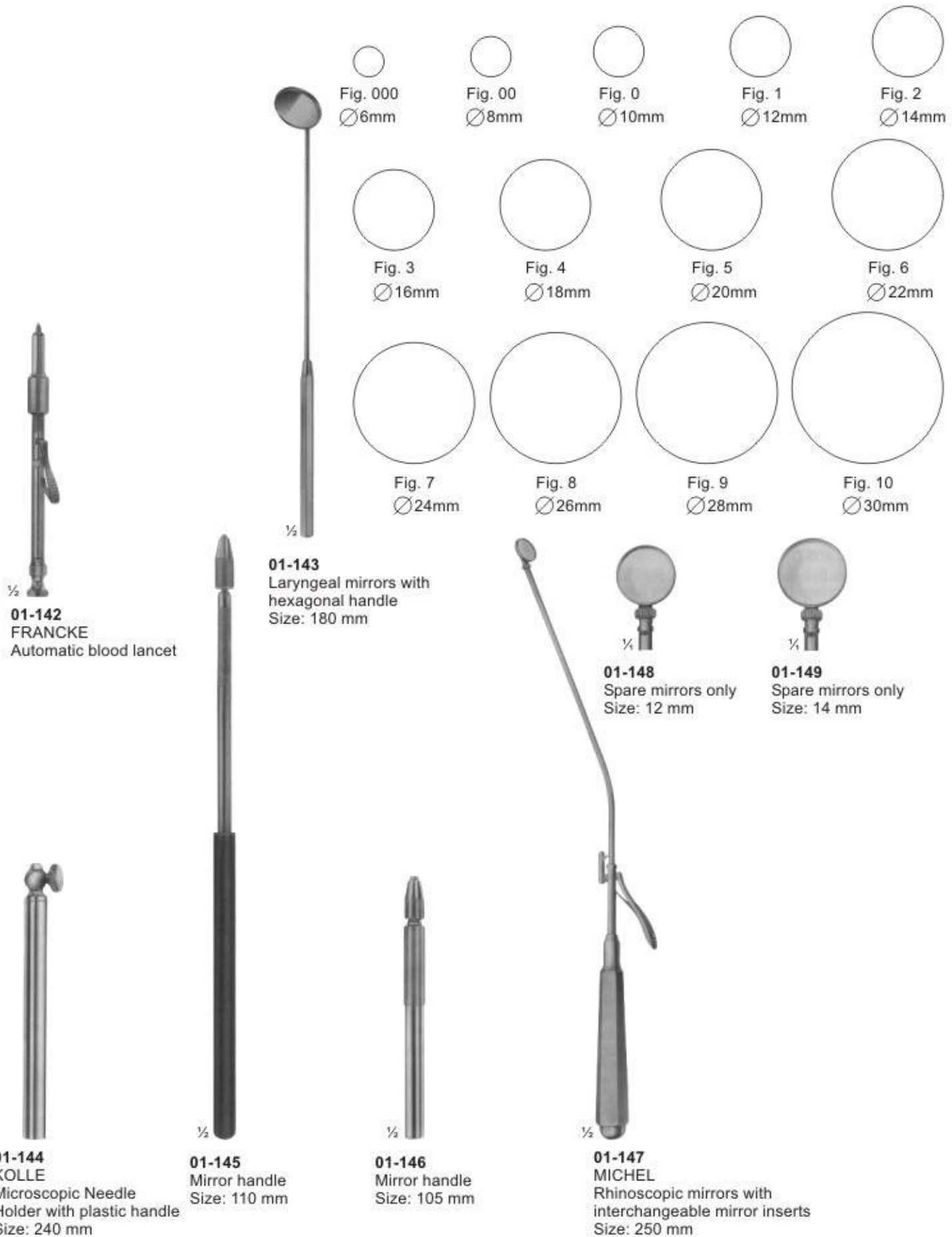

Laryngoscope and Diagnostic Sets Laryngoskope und Diagnostikbestecke



1/2

01-150 - 152
MAGILL



01-150
Infants
Size: 150 mm



01-151
Children
Size: 200 mm



01-152
Adults
Size: 250 mm



1/2

01-153
Medium battery handle
only, 25 mm diam.



01-153-A
Spare bulb
2.7 volt, for
otoscopes



01-153-B
Spare bulb
2.6 volt, for
ophthalmoscopes



01-154
Otoscope set, consists of
battery handle without batteries,
3 ear specula, 1 bulb in velvet lined case



01-155
Diagnostic set, otoscope with three specula,
nasal speculum, lamp holder, two laryngeal
mirrors, tongue blade holder

Laryngoscopes Laryngoskope

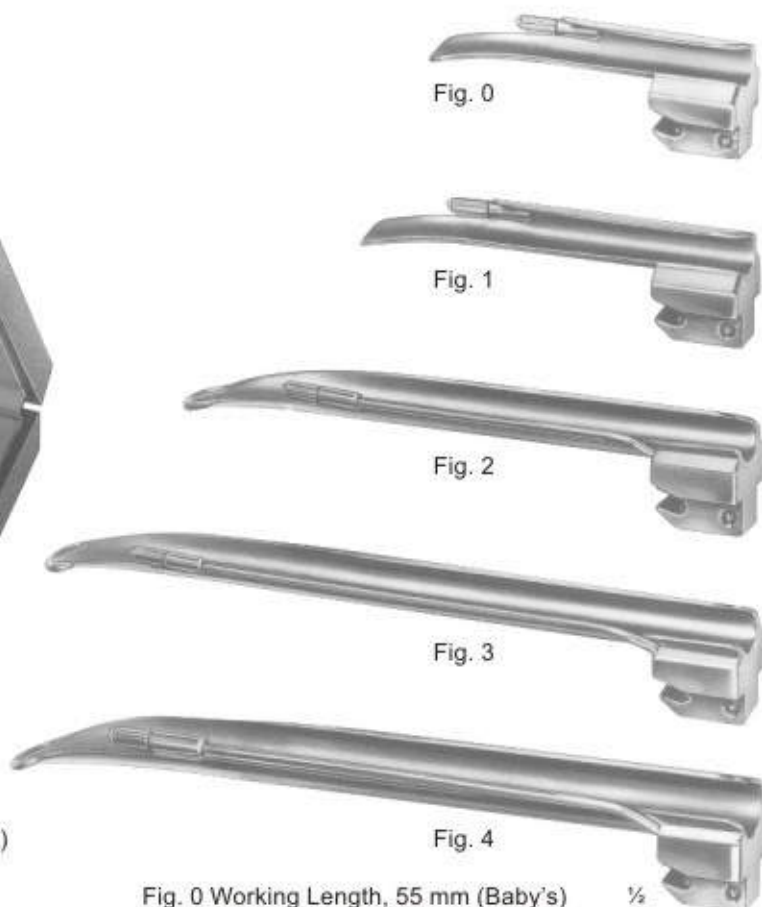

01-156
MILLER
Laryngoscope set, consists of battery handle (without battery)
with four miller laryngoscope blades

Fig. 0 Working Length, 55 mm (Baby's) $\frac{1}{2}$
Fig. 1 Working Length, 80 mm (Children's)
Fig. 2 Working Length, 130 mm (Adolescent's)
Fig. 3 Working Length, 170 mm (Women's)
Fig. 4 Working Length, 180 mm (Men's)

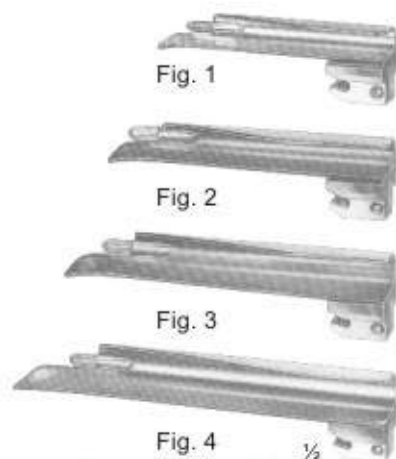

01-157
GUEDEL-NEGUS
Laryngoscope set, consists of battery handle (without battery)
with four miller laryngoscope blades

Fig. 1 Working Length, 70 mm (Children's)
Fig. 2 Working Length, 90 mm (Adolescent's)
Fig. 3 Working Length, 110 mm (Women's)
Fig. 4 Working Length, 135 mm (Men's)

Dissecting Knives Anatomische Skalpelle



02-101 - 110
Fig. 1 - 10



02-101
Fig. 1
30 mm



02-102
Fig. 2
36 mm



02-103
Fig. 3
40 mm



02-104
Fig. 4
45 mm



02-105
Fig. 5
50 mm



02-106
Fig. 6
27 mm



02-107
Fig. 7
35 mm



02-108
Fig. 8
40 mm



02-109
Fig. 9
47 mm



02-110
Fig. 10
50 mm



LISTON
 02-111
 Size: 130 mm
 02-112
 Size: 160 mm
 02-113
 Size: 190 mm
 02-114
 Size: 200 mm

02-115
 CATLIN
 Size: 160 mm
 Blade length
 Amputating
 Knives

02-116
 LANGENBECK
 Size: 120 mm
 Blade length
 Flap Knives

02-117
 Size: 110 mm
 Blade length
 Interosseous
 Knives

02-118
 Size: 55 mm
 Blade length
 with raspatory,
 Wooden handle

02-119
 Size: 70 mm
 Blade length
 Wooden handle

02-120
 Size: 80 mm
 Blade length
 Metal handle

02-121
 Size: 195 mm
 Blade length
 Metal handle

Blade length
 Amputating Knives

Cone Knives, Myomatome, Trigeminal and Tonsil Knives
 Konisationsmesser, Myommesser, Trigeminus und
 Tonsillenmesser



02-122
 AYRE
 Size: 235 mm
 Cone Knife

02-123
 Size: 230 mm
 Cone Knife

02-124
 SEGOND
 Size: 270 mm
 Myomatome

02-125
 OLIVECRONA
 Size: 205 mm
 Trigeminal
 Knife

02-126
 Size: 230 mm
 Trigeminal
 Knife

02-127
 FOWLER
 Size: 200 mm
 Tonsil Knife

02-128
 ABRAHAM
 Size: 215 mm
 Tonsil Knife

02-129
 BRUNINGS
 Size: 215 mm
 Tonsil Knife

Scalpel Handles Skalpellgriffe



02-130 STANDARD No. 3 Solid 12 cm	02-131 No. 3 Solid 12 cm	02-132 No. 3 Solid 12 cm	02-133 No. 3 L Straight Solid 21.5 cm	02-134 No. 3 L Angled Solid 21 cm	02-135 No. 7 Solid 16 cm	02-136 No. 7 K Solid 12.5 cm	02-137 Hollow-Round 15.5 cm	02-138 No. 3 Straight Solid, Round 14.5 cm	02-139 No. 3 Angled Solid, Round 14 cm
--	--	--	--	--	--	--	--	--	--

Micro Scissors (Spring Type) with Flat Handles
Mikro-Federscheren mit Flachgriffen

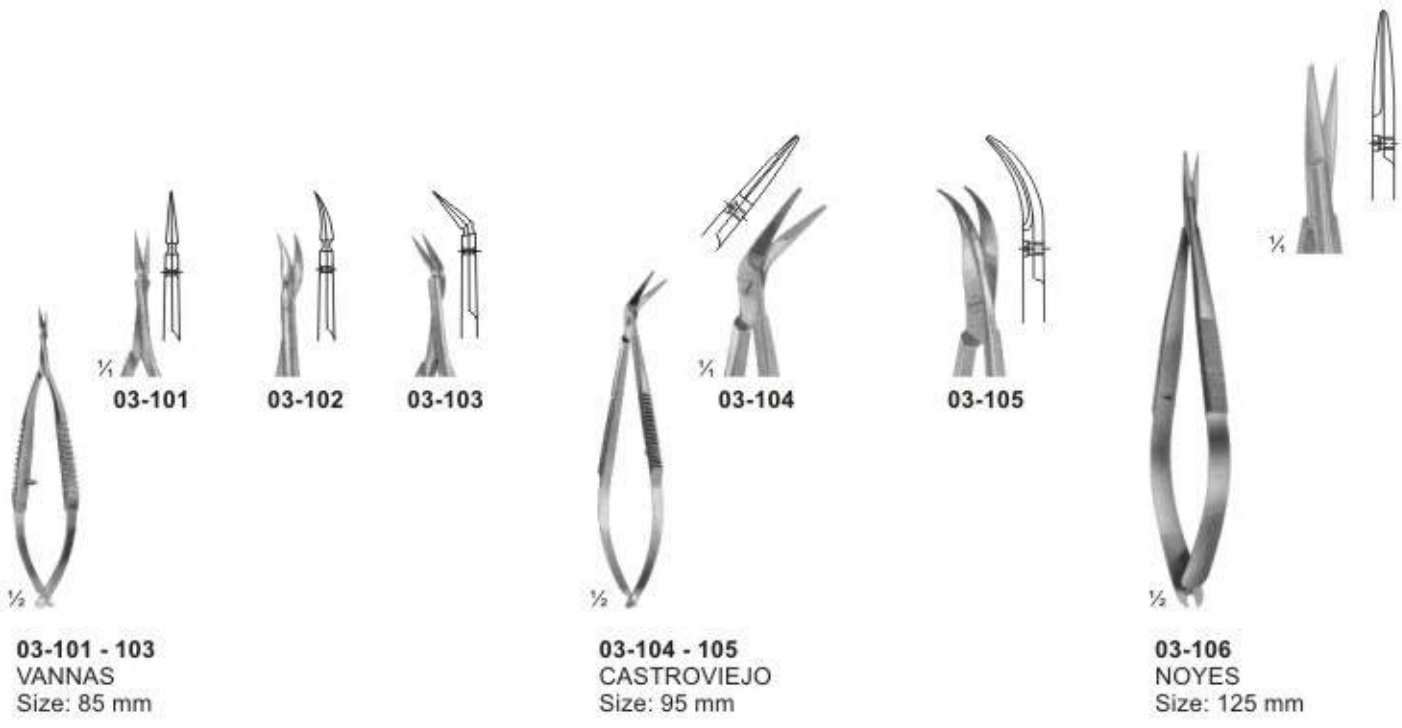

03-101 - 103
VANNAS
 Size: 85 mm

03-104 - 105
CASTROVIEJO
 Size: 95 mm

03-106
NOYES
 Size: 125 mm

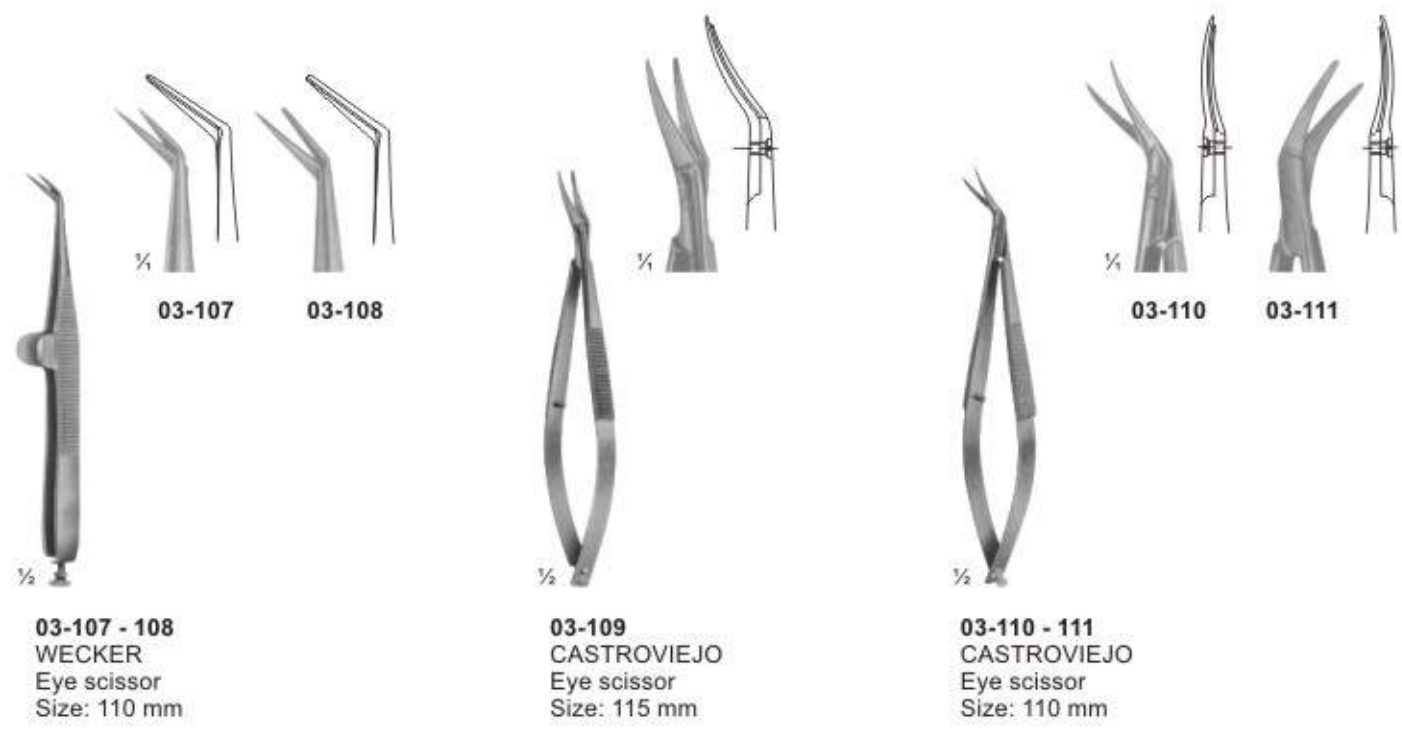

03-107 - 108
WECKER
 Eye scissor
 Size: 110 mm

03-109
CASTROVIEJO
 Eye scissor
 Size: 115 mm

03-110 - 111
CASTROVIEJO
 Eye scissor
 Size: 110 mm

Micro Scissors (Spring Type) with Flat Handles
Mikro-Federscheren mit Flachgriffen

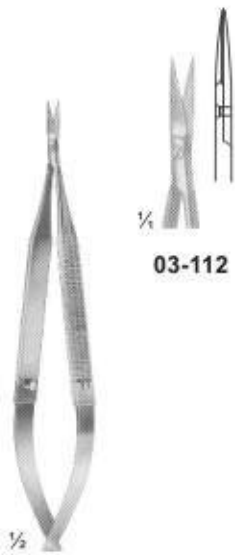

03-112

03-112 - 113
 Size: 120 mm



03-113



03-114
 BIEMER
 Vein scissor
 Size: 130 mm



03-115
 Size: 160 mm



03-116

03-116 - 117
 VANNAS
 Size: 160 mm



03-117

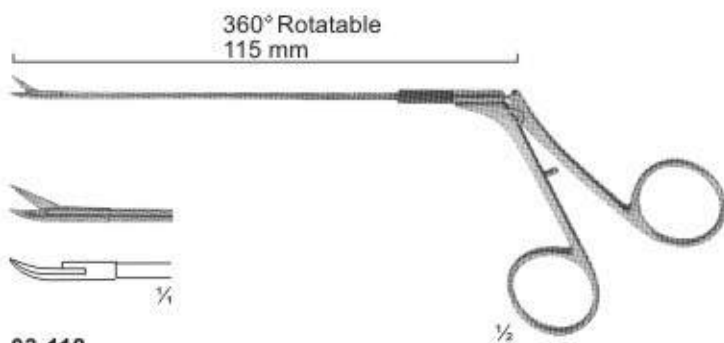

03-118
 CASPAR
 Micro scissor curved
 Size: 115 mm



03-119



03-120



03-121



03-119 - 121
 Micro dissecting scissor
 Size: 145 mm

Micro Scissors (Spring Type) bayonet-Shaped
Mikro-Federscheren, bajonettformig



03-122
YASARGIL
 Size: 245 mm



03-123
 45°



03-124
 45°



03-123 - 124
 laterally angled
 Size: 200 mm

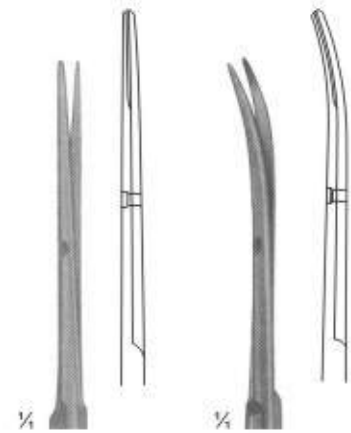

03-126

03-127



03-125
 laterally angled
 Size: 190 mm



03-126 - 127
YASARGIL
 Size: 225 mm

Delicate Scissors Feine Scheren



03-128 - 129
Size: 90 mm

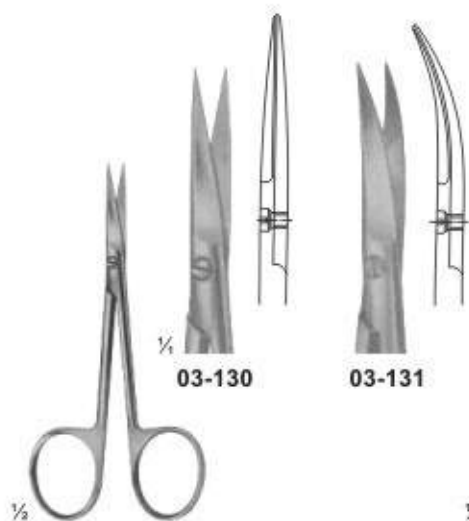

03-130 - 131
Size: 95 mm



03-132 - 133
Size: 105 mm

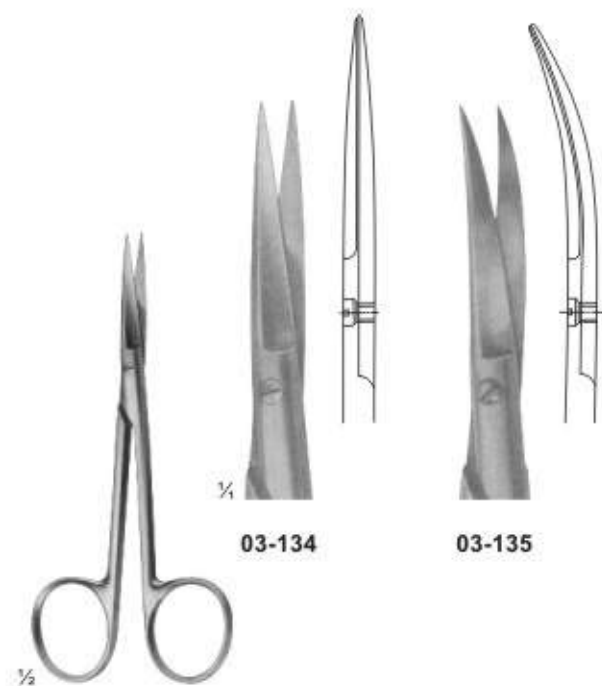

03-134 - 135
Size: 120 mm



03-136 - 137
Size: 115 mm

Delicate Scissors
Feine Scheren



03-138 - 140
Size: 120 mm



03-138



03-139



03-140

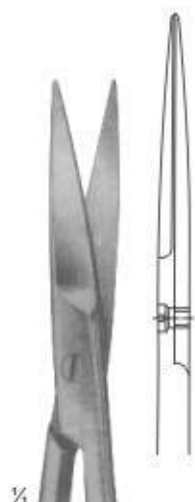

03-141



03-142

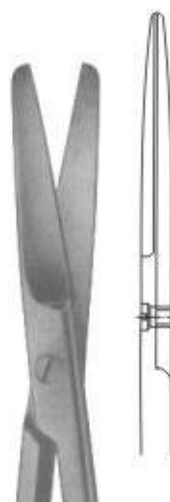

03-143



03-144



03-141 - 144
Size: 130 mm

Surgical Scissors Chirurgische Scheren

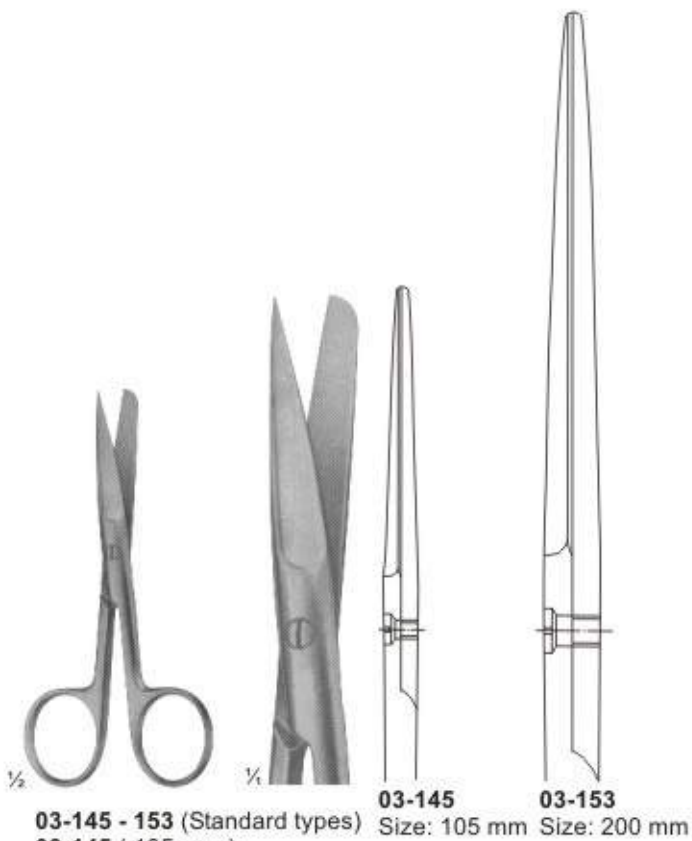

03-145 - 153 (Standard types)

- 03-145 (105 mm)
- 03-146 (115 mm)
- 03-147 (130 mm)
- 03-148 (145 mm)
- 03-149 (150 mm)
- 03-150 (165 mm)
- 03-151 (175 mm)
- 03-152 (185 mm)
- 03-153 (200 mm)

03-154 - 160 (Standard types)

- 03-154 (115 mm)
- 03-155 (130 mm)
- 03-156 (145 mm)
- 03-157 (150 mm)
- 03-158 (165 mm)
- 03-159 (175 mm)
- 03-160 (185 mm)

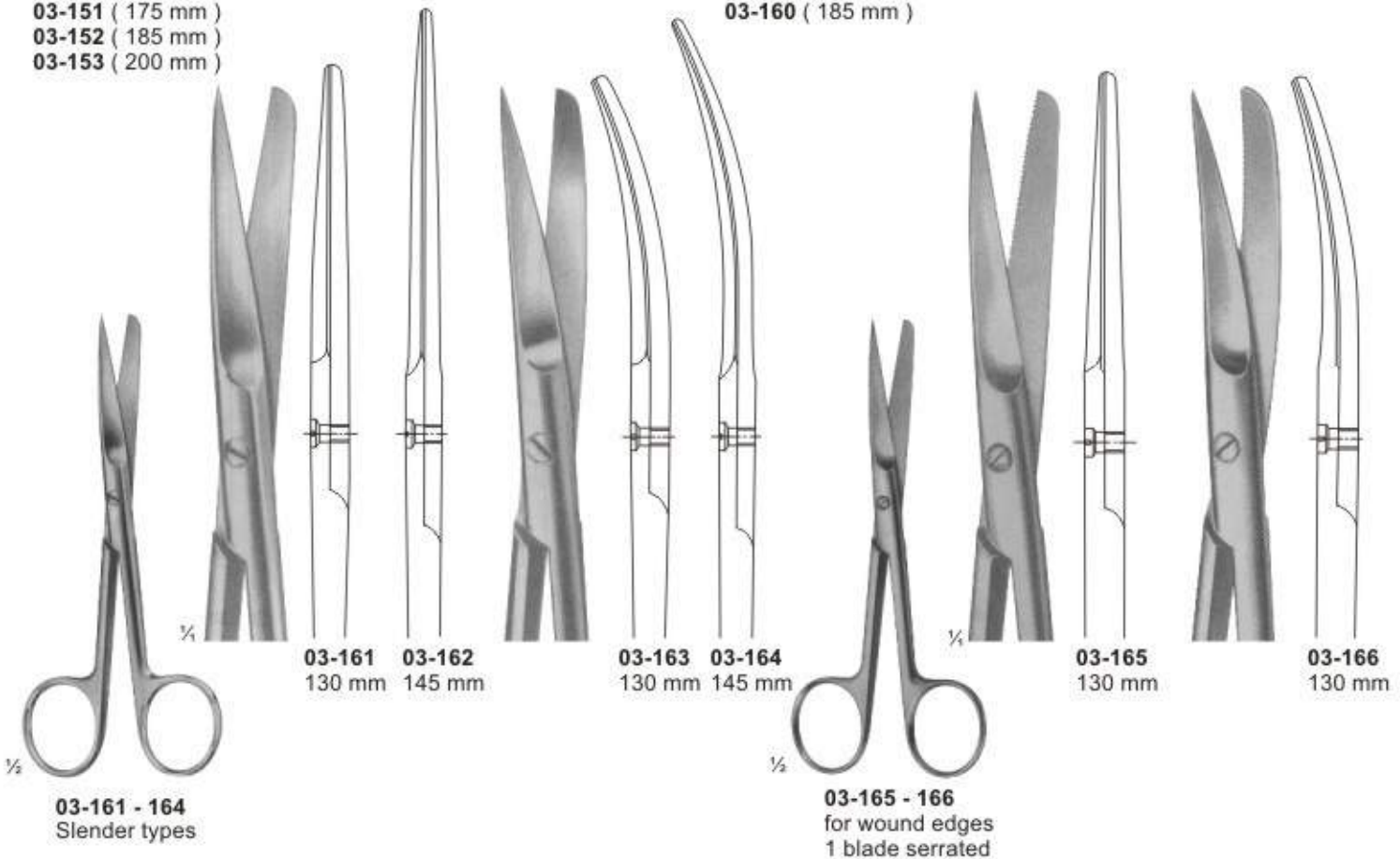

03-161 - 164
Slender types

03-165 - 166
for wound edges
1 blade serrated



03-167 - 169
 DEAVER
 with flat lock

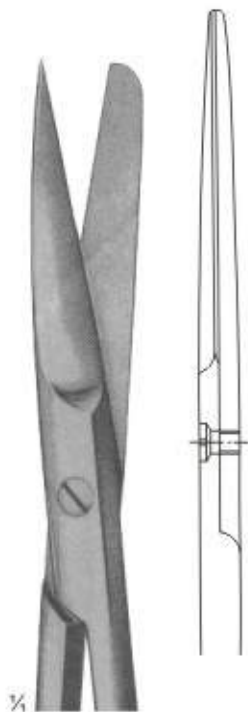

03-167
 Size: 145 mm

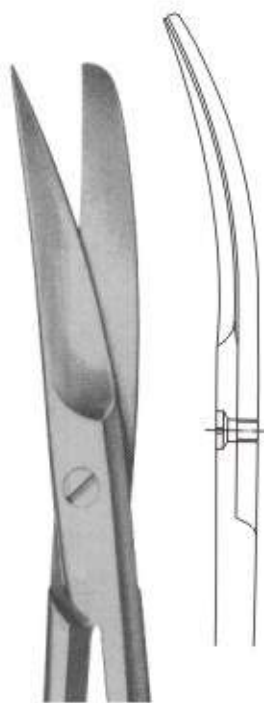

03-168
 Size: 145 mm

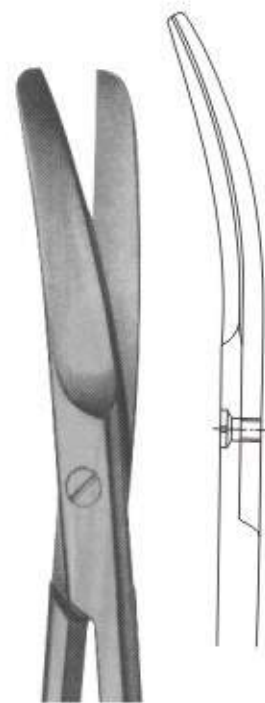

03-169
 Size: 145 mm



03-170 - 172
 Incision scissors

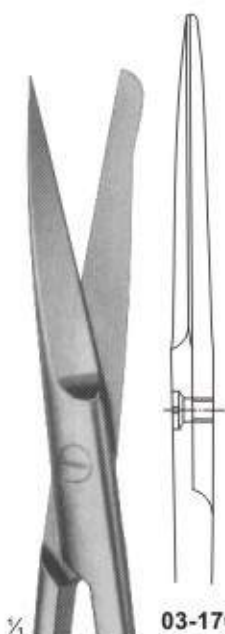

03-170
 Size: 130 mm

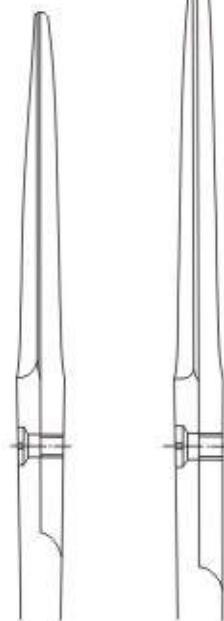

03-171
 Size: 145 mm



03-172
 Size: 165 mm



03-173
 SYSTRUNK
 Nail splitting scissors



03-173
 Size: 130 mm

Dissecting Scissors Praparierscheren

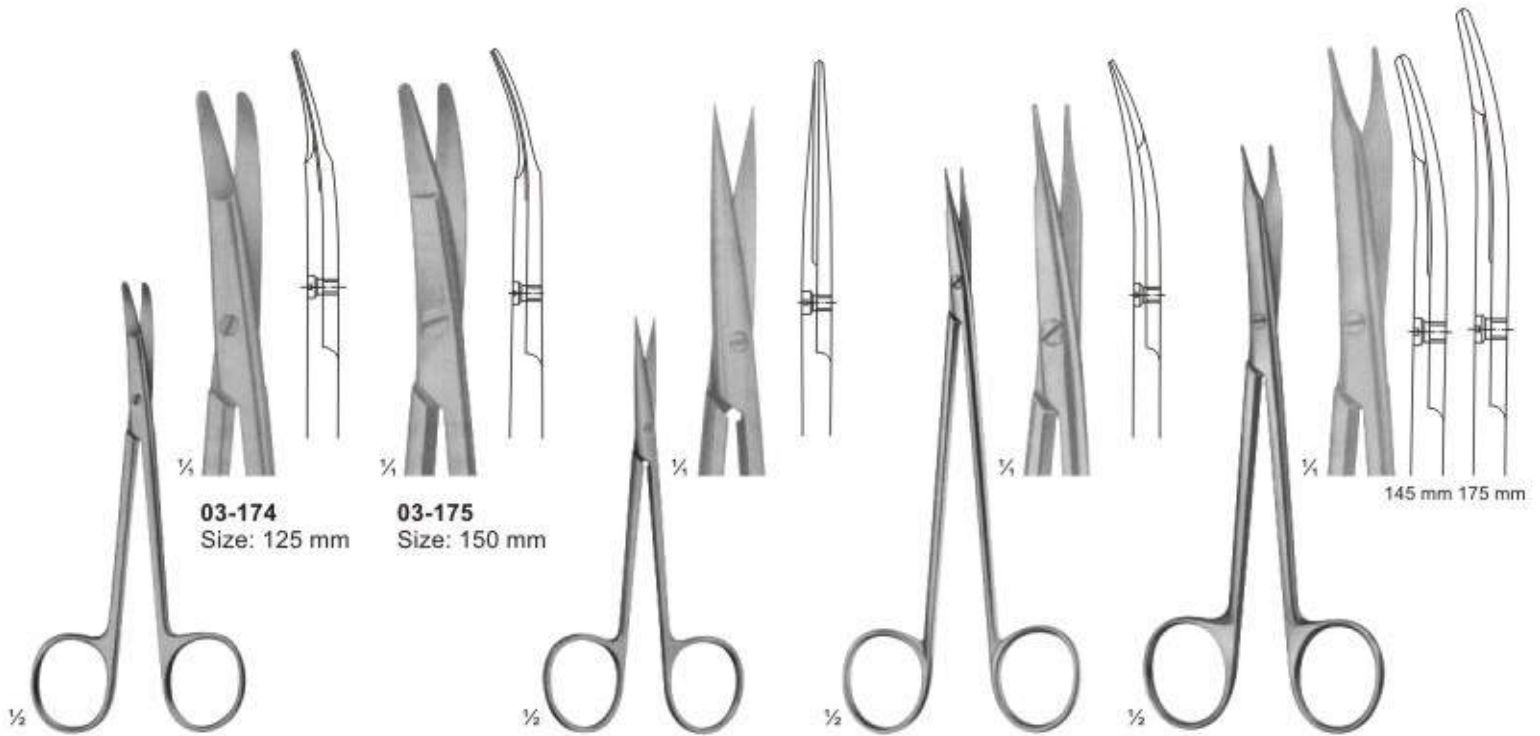

03-174 - 175
KILNER
Special flat points for dissecting
and undermining the skin

03-176
KILNER
Fine dissecting scissors
Size: 115 mm

03-177
JAMESON
Dissecting scissors
Size: 150 mm

03-178
REYNOLDS
Dissecting scissors
Size: 145 - 175 mm

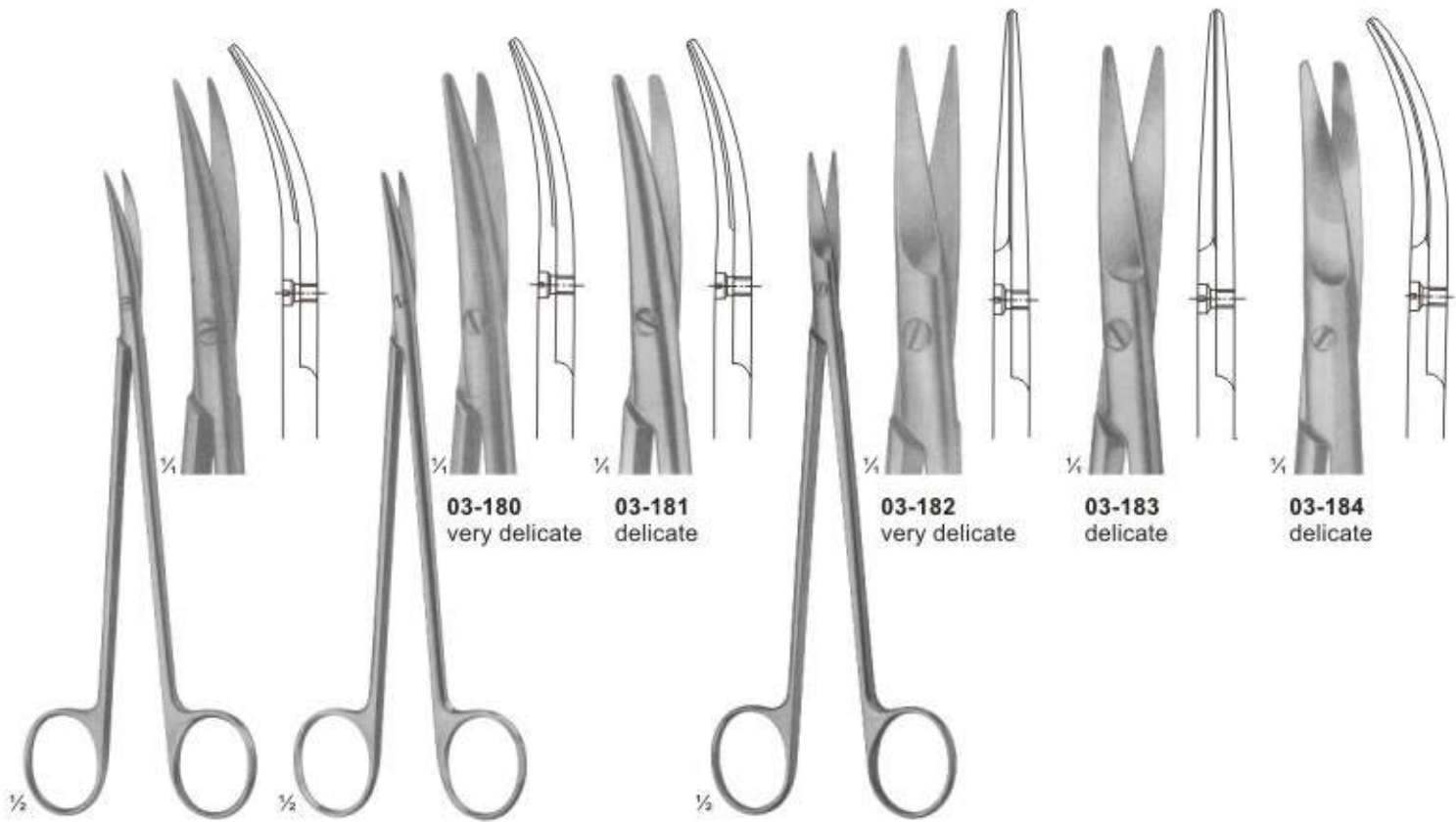

03-179
DE BAKEY
Arteriotomy scissors
Size: 175 mm

03-180 - 181
TOENNIS ADSON
Dissecting scissors
Size: 175 mm

03-182 - 184
TOENNIS
Dissecting scissors
Size: 180 mm

**Dissecting Scissors
Praparierscheren**

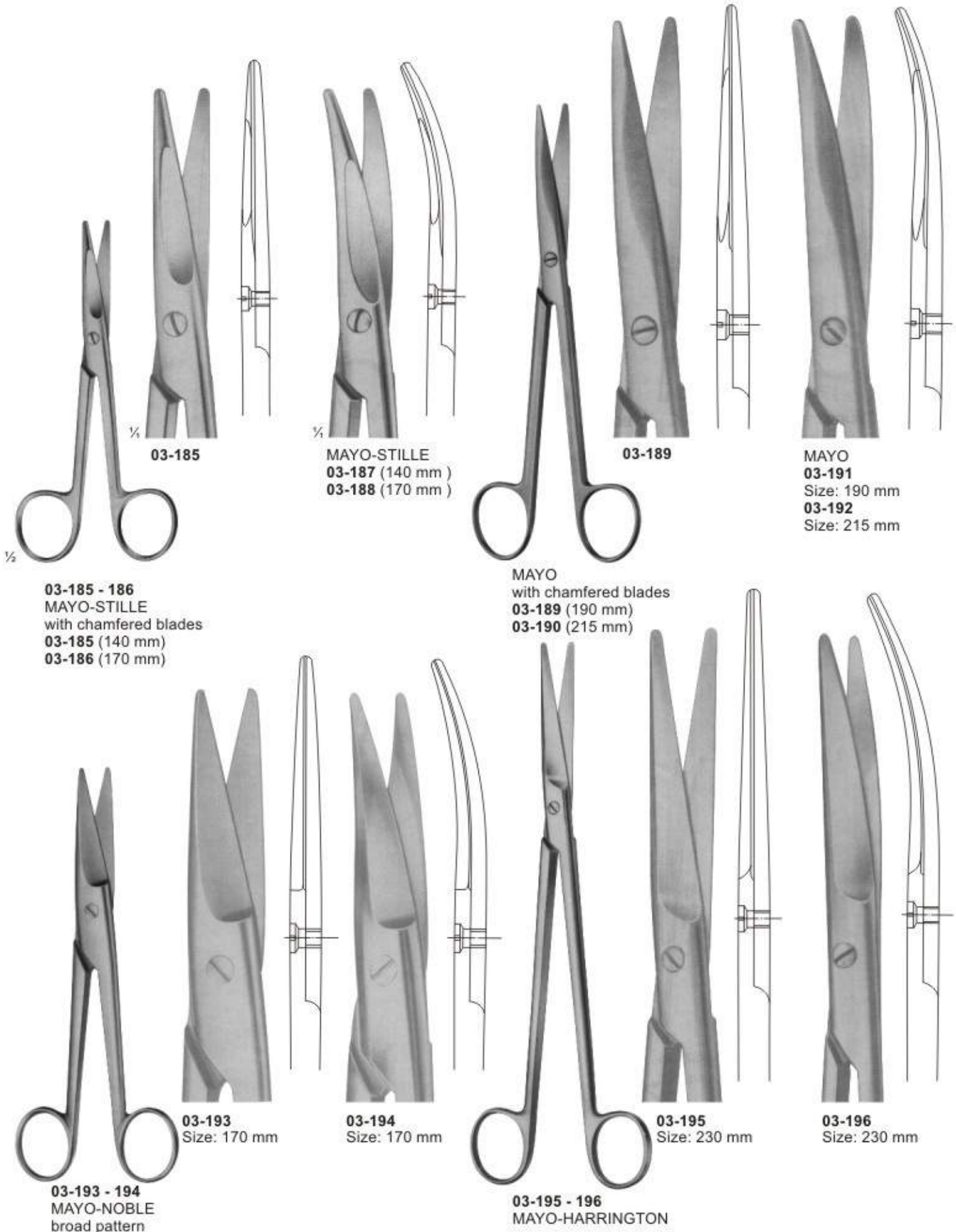

Scissors for Cardiovascular and Neuro-Surgery
 Scheren für Herz-, Gefäß- und Neurochirurgie

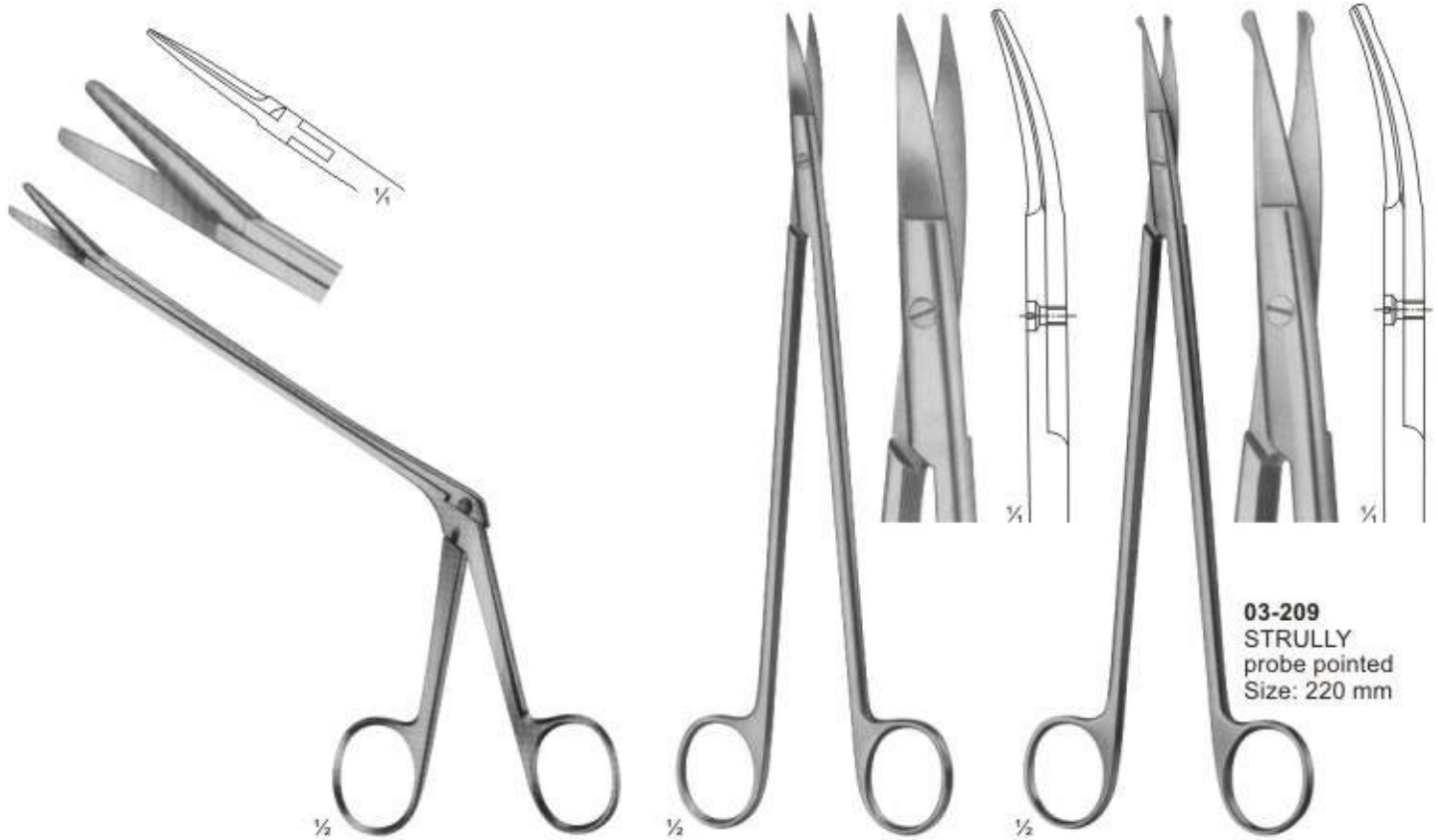

03-207
 OLIVECRONA
 Dura scissors

03-208
 STRULLY
 pointed
 Size: 220 mm

03-209
 STRULLY
 probe pointed
 Size: 220 mm

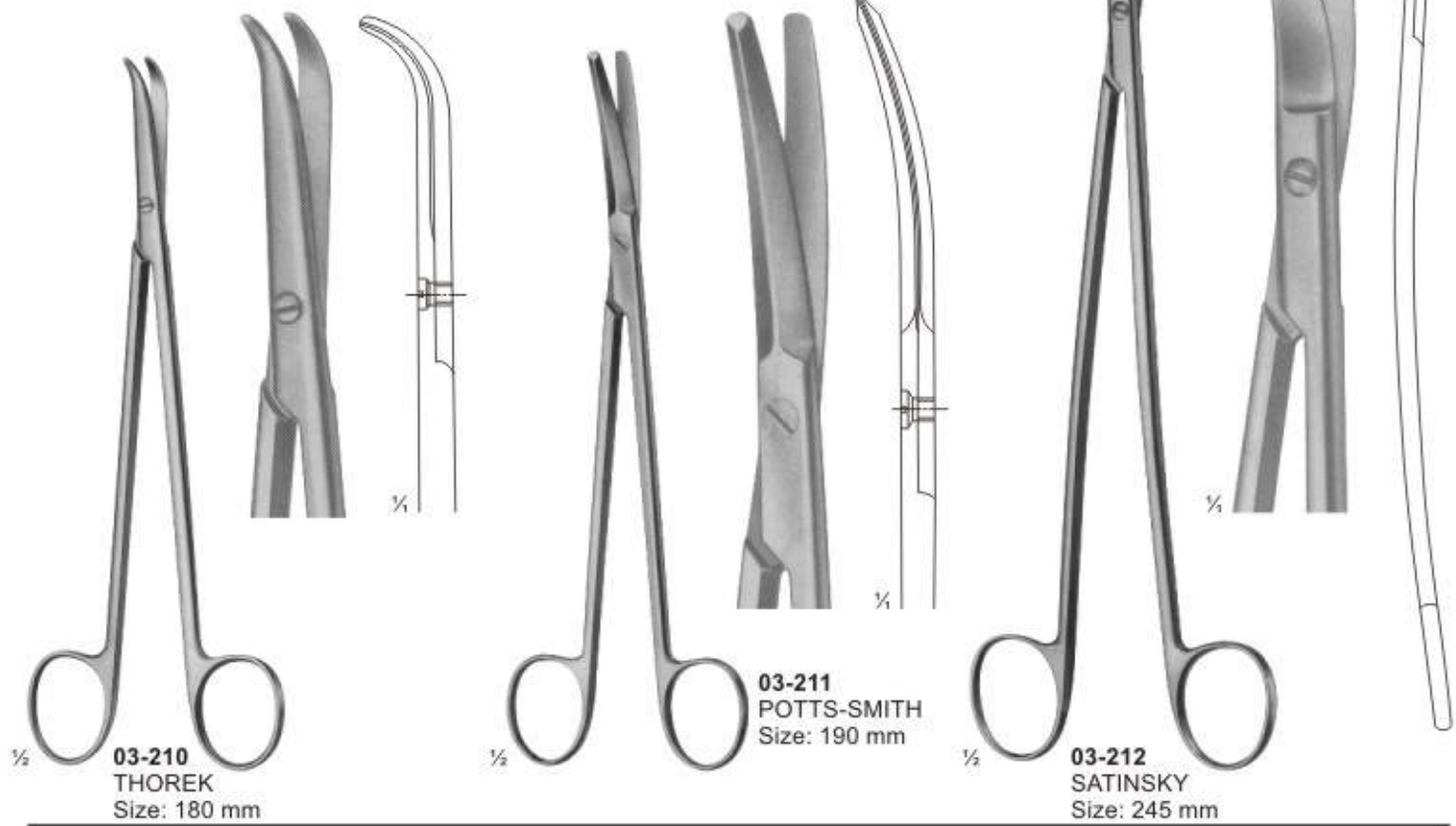

03-210
 THOREK
 Size: 180 mm

03-211
 POTTS-SMITH
 Size: 190 mm

03-212
 SATINSKY
 Size: 245 mm

Delicate, Nasal and Tonsil Scissors
Feine, Nasen und Tonsillenscheren

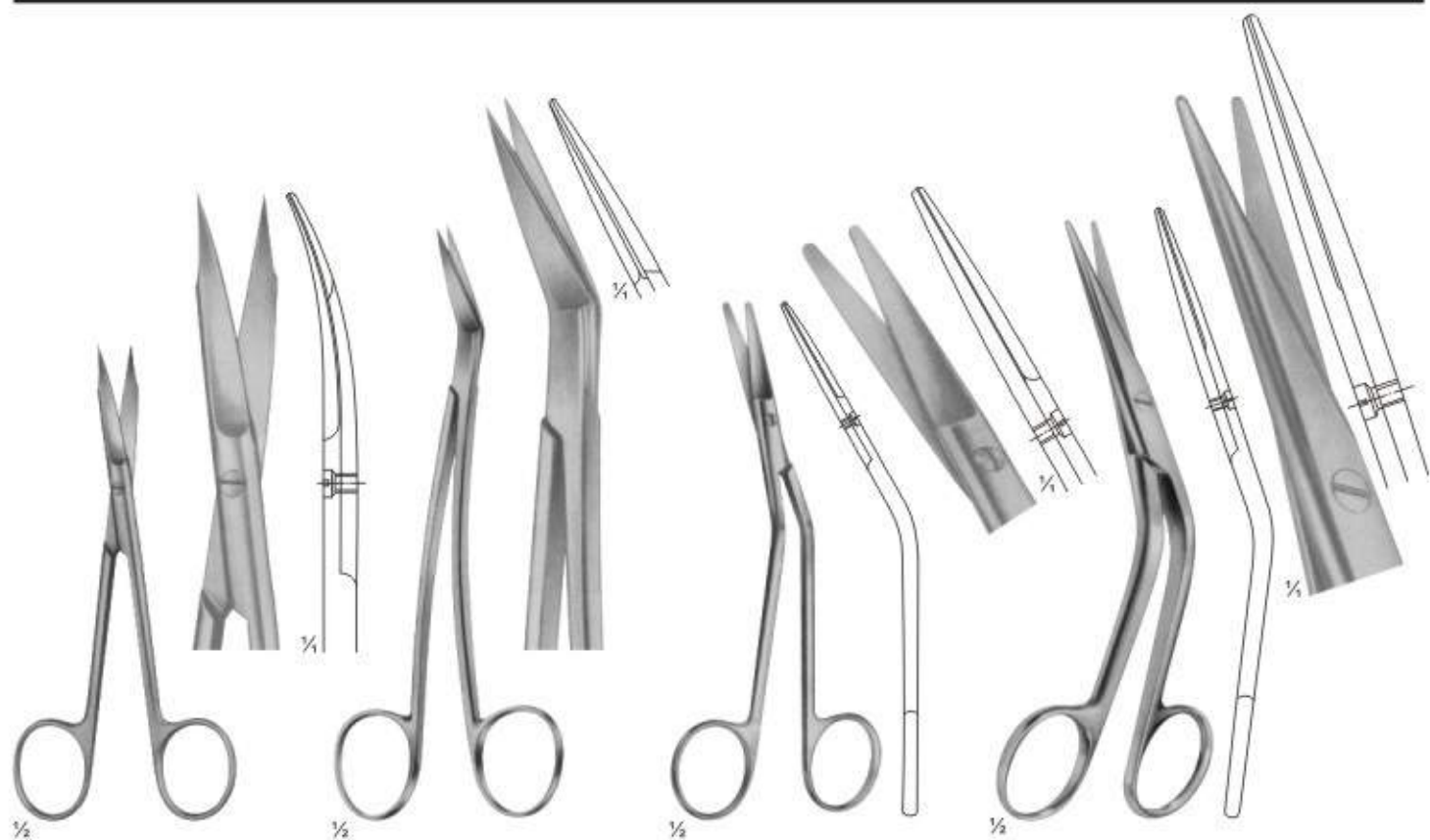

03-213
 1 finely toothed blade
 Size: 130 mm

03-214
LOCKLIN
 curved sideways,
 1 toothed blade
 Size: 155 mm

03-215
FOMON
 blades serrated
 Size: 145 mm

03-216
COTTLE
 Size: 165 mm

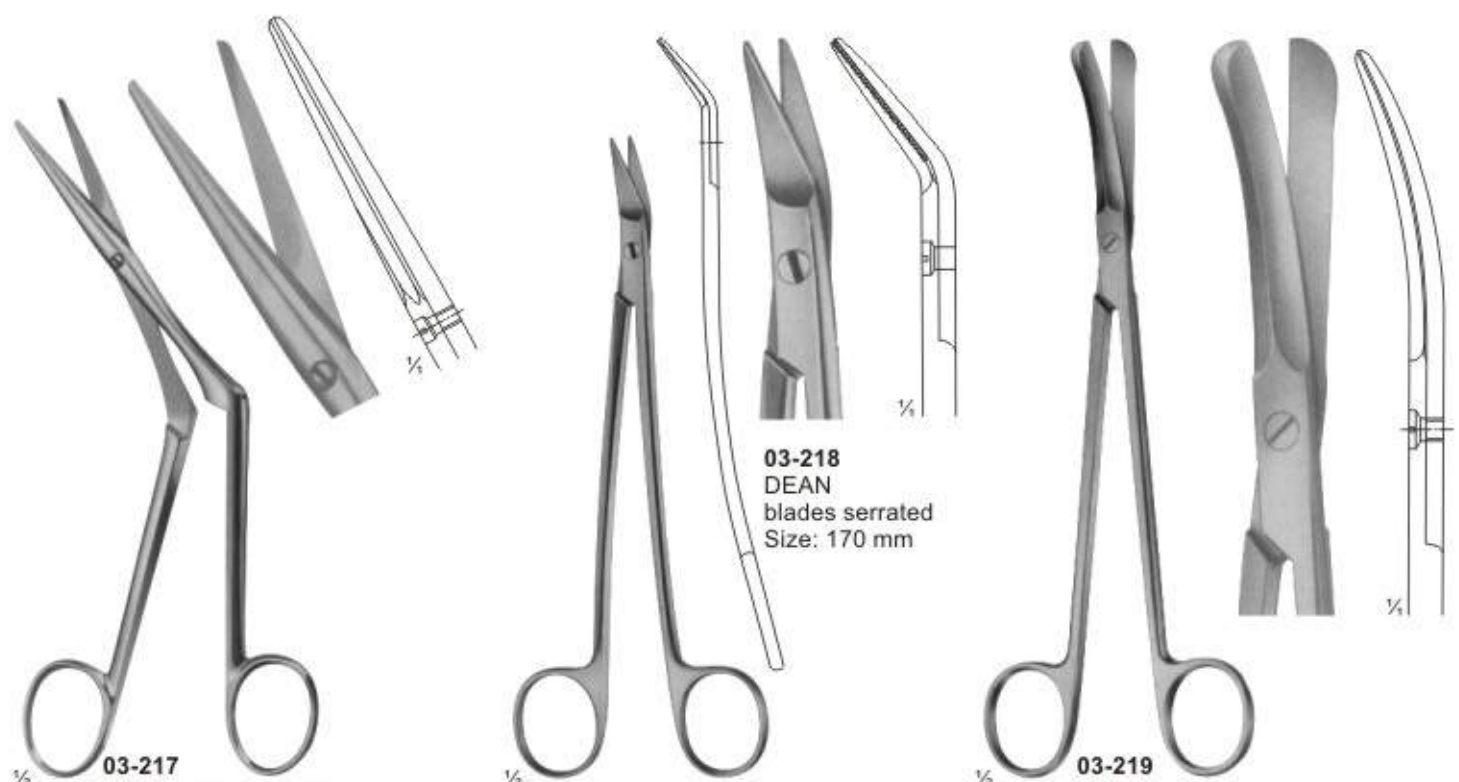

03-217
HEYMANN-KNIGHT
 Size: 175 mm

03-218
DEAN
 blades serrated
 Size: 170 mm

03-219
GOOD
 Size: 195 mm

Bone Shears
Knochenscheren

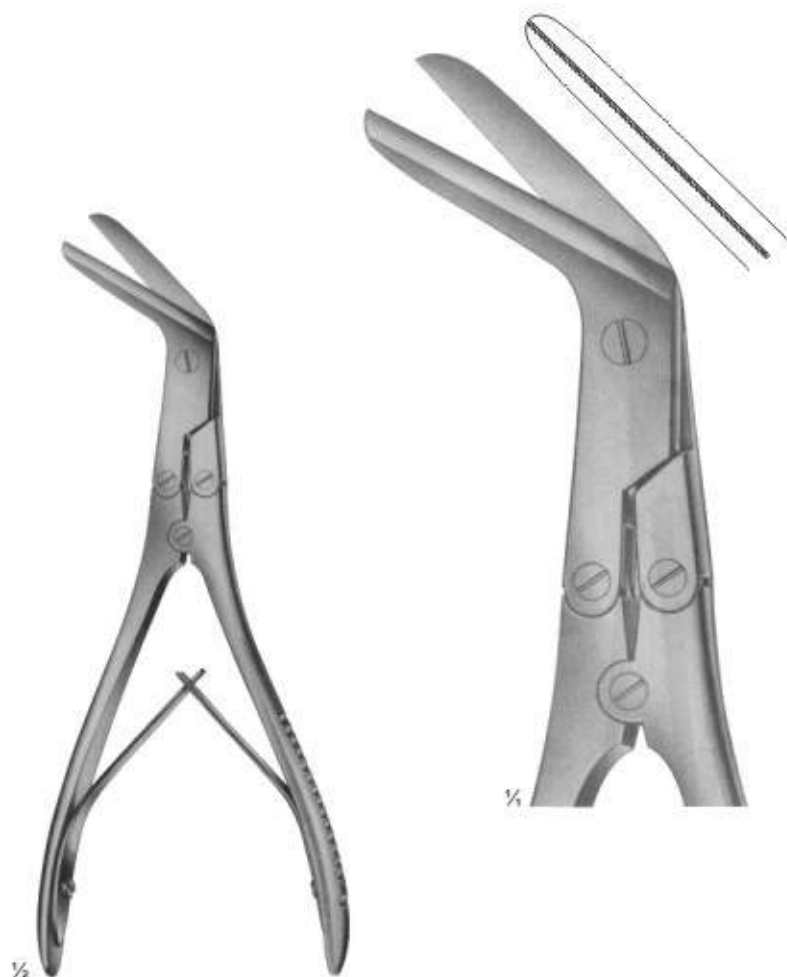

03-220
KILLIAN
Size: 200 mm



03-221 - 222



03-221
195 mm



1/4



03-222
225 mm



1/4

Scissors for deep operations and for Gynaecology
 Scheren für operationen in der Tiefe und für
 Gynakologie

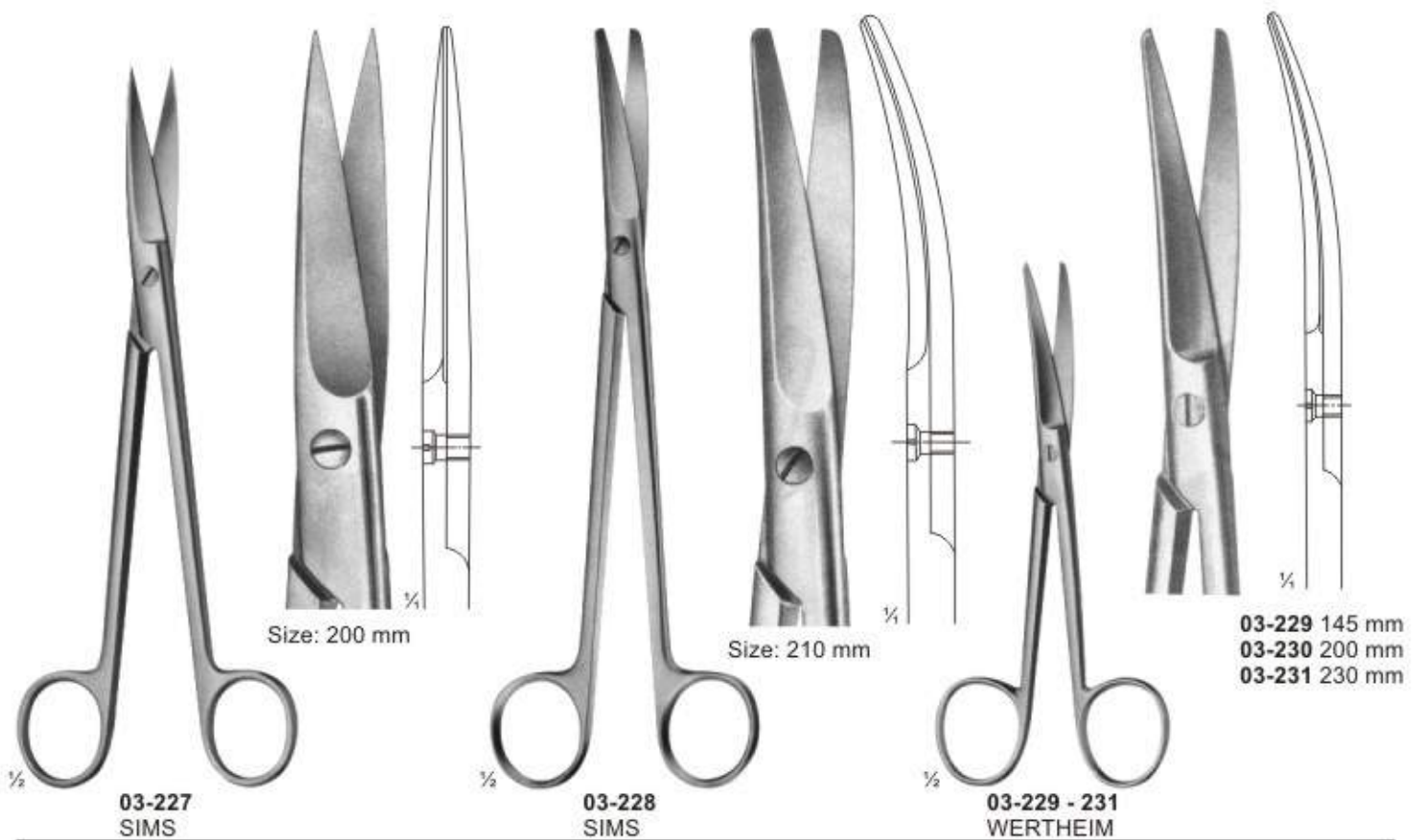
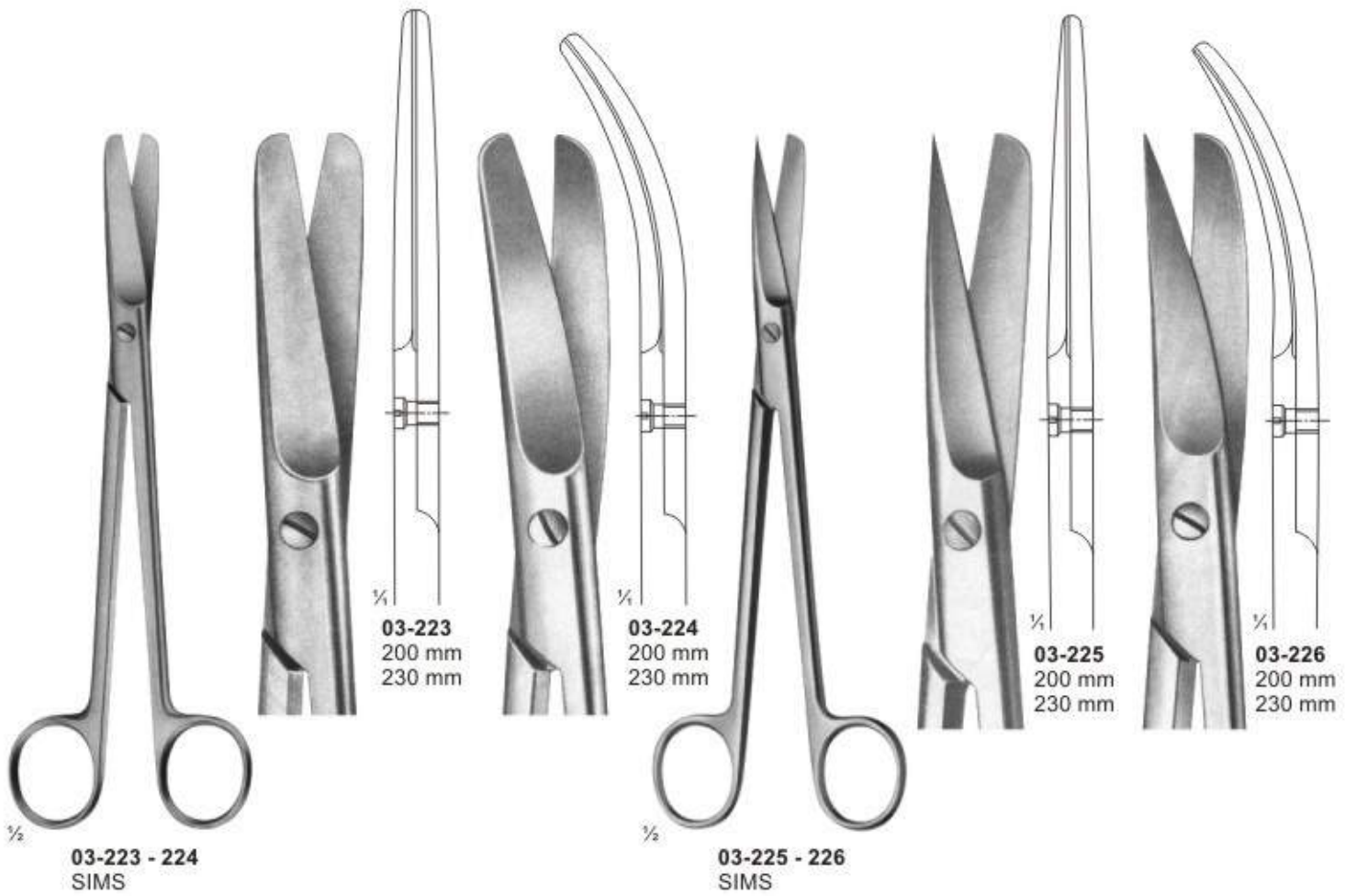



03-232
SCHUMACHER
Umbilical cord scissors
Size: 155 mm



03-233
Umbilical cord scissors
Size: 105 mm

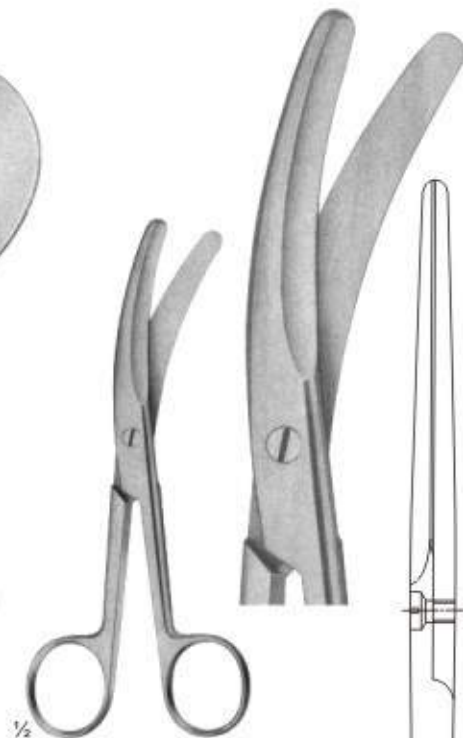

03-234
Umbilical cord scissors



135 mm

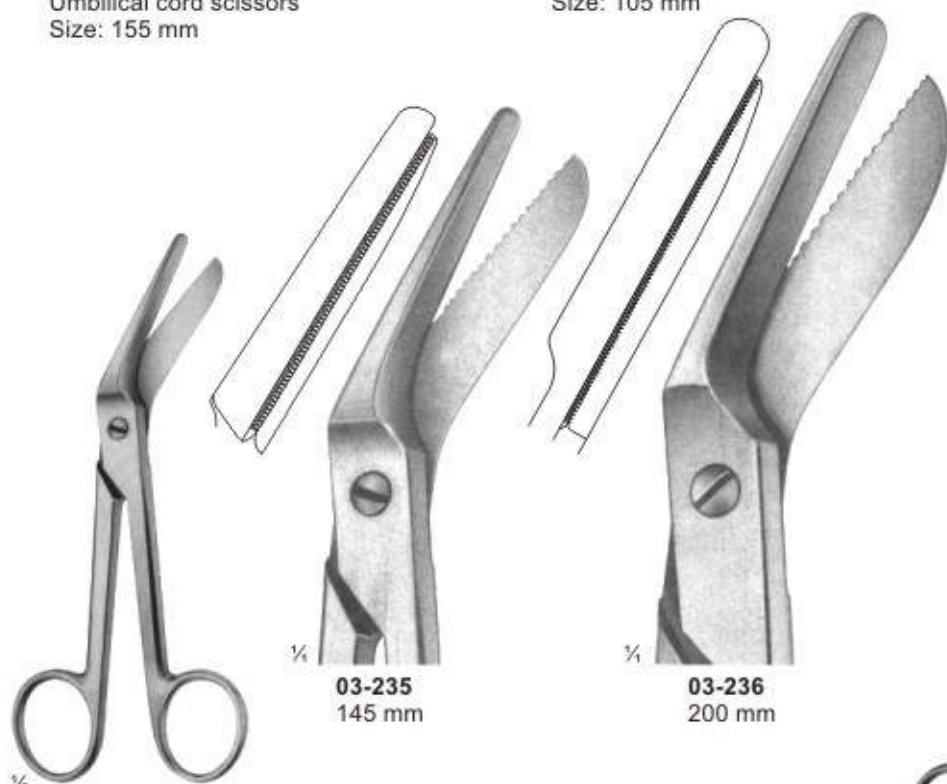

03-235
145 mm

03-236
200 mm

03-235 - 236
BRAUN-STADLER
Episiotomy scissors



03-237
Episiotomy scissors
240 mm

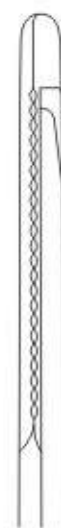

**Wire and Plate Scissors
Draht und Blechscheren**



1/2

03-238 - 242
BEEBE
Size: 110 mm



1/4

03-238



1/4

03-239



1/4

03-240
broad blades



1/4

03-241
1 blade serrated

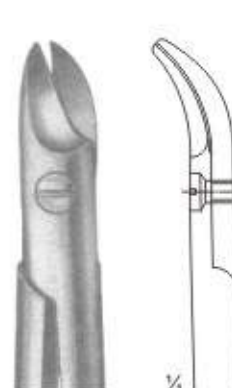

1/4

03-242
NAUJOKS
strongly curved

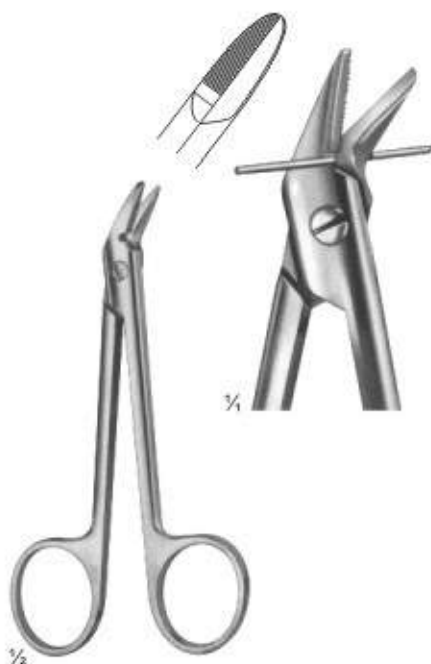

1/2

03-243
1 blade serrated
Size: 120 mm



1/4

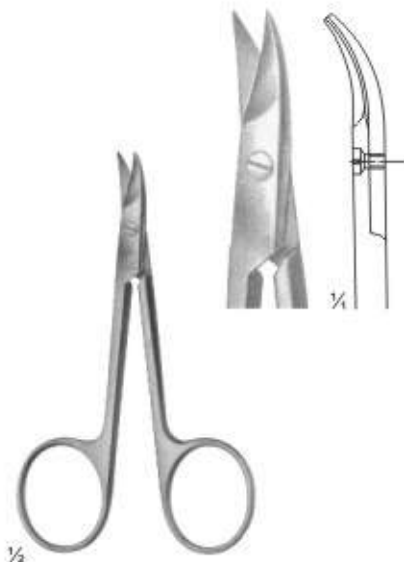

1/2

03-244
STRACK
Size: 100 mm

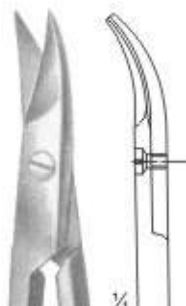

1/4

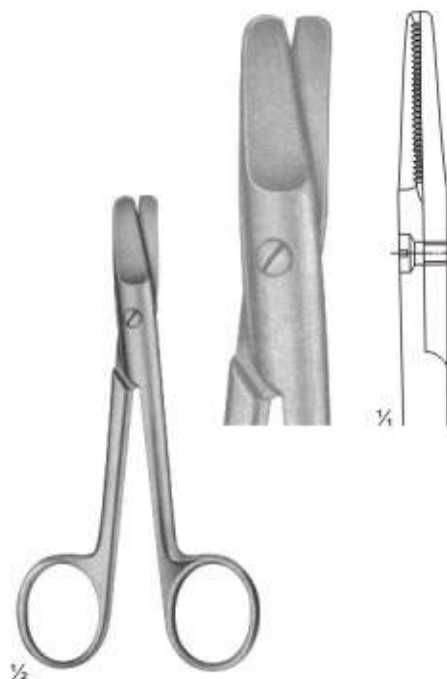

1/2

03-245
HARVEY
blades serrated
Size: 125 mm

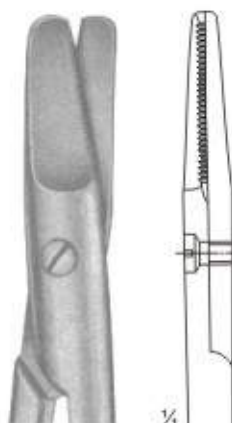

1/4



03-246
 Universal bandage and cloth scissors,
 with toothed edges
 180 mm



03-247
LISTER
 Universal bandage and cloth scissors,
 with toothed edges
 Size: 145 mm

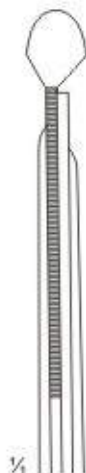

03-248
LISTER
 Nurse's scissors
 Size: 145 mm

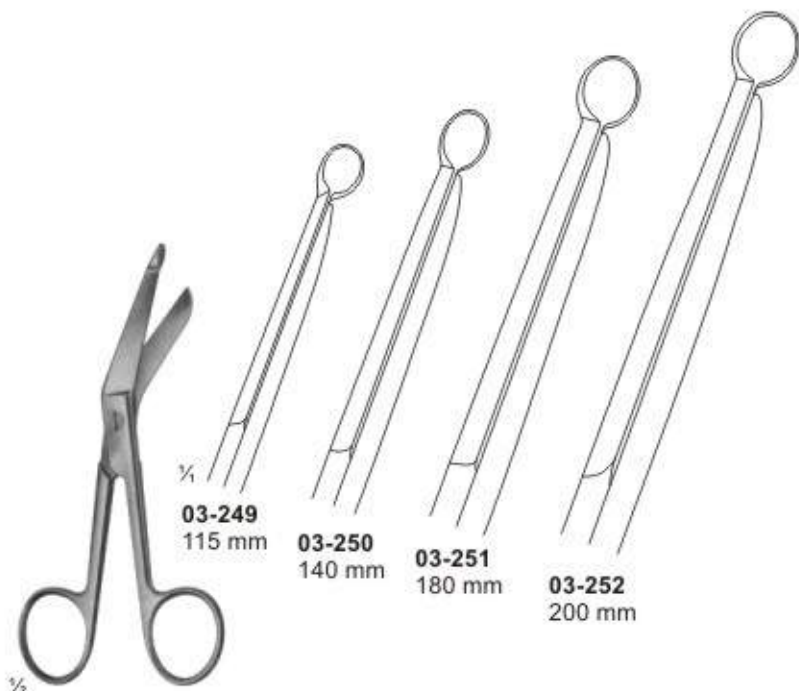

03-249 - 252
LISTER

03-249
 115 mm

03-250
 140 mm

03-251
 180 mm

03-252
 200 mm

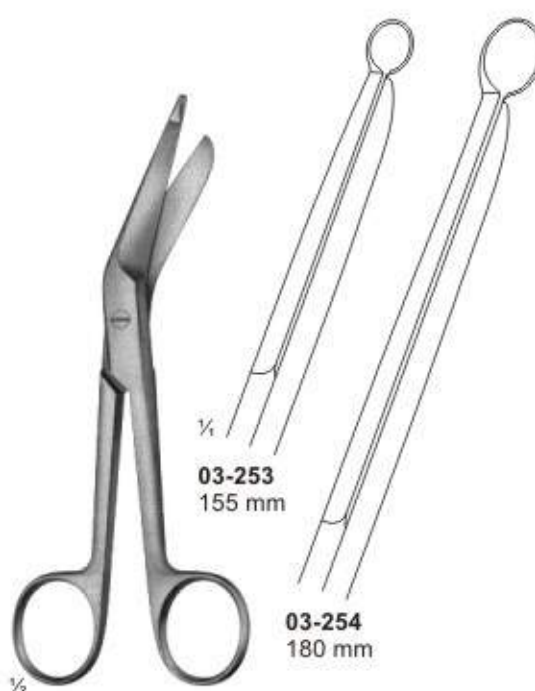

03-253 - 254
LISTER

03-253
 155 mm

03-254
 180 mm

Bandage-, Cloth-, and Plaster Scissors
Verbands-, Kleider- und Gipsscheren



03-255
CLOTH SCISSORS
 205 mm

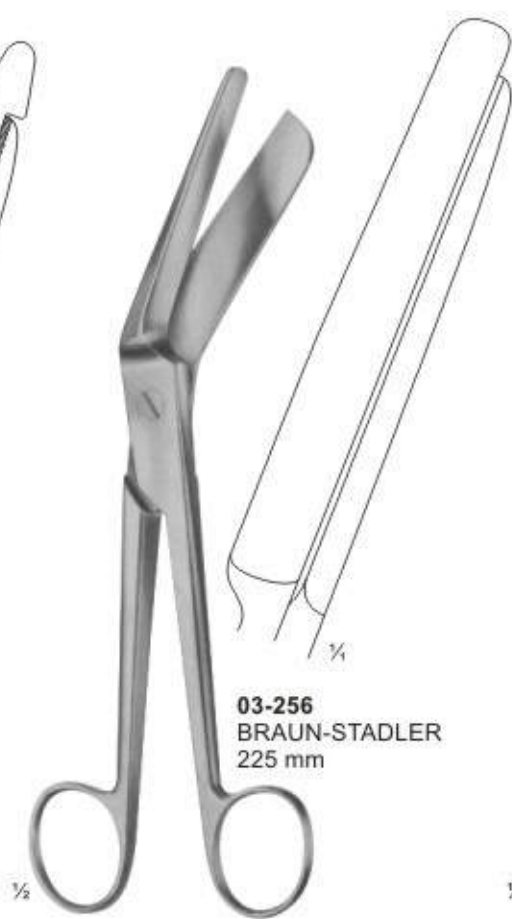

03-256
BRAUN-STADLER
 225 mm



03-257
SEUTIN
 230 mm



03-258 - 259
ESMARCH



03-258 200 mm
03-259 230 mm

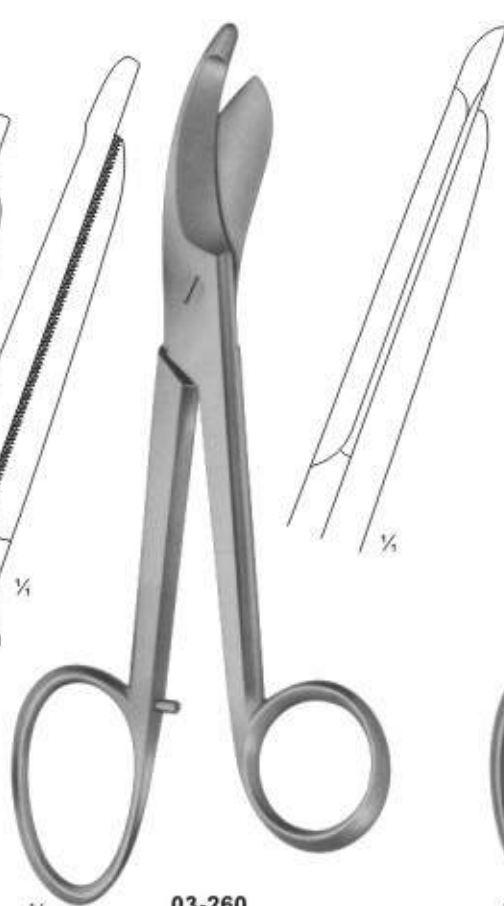

03-260
BRUNS
 235 mm

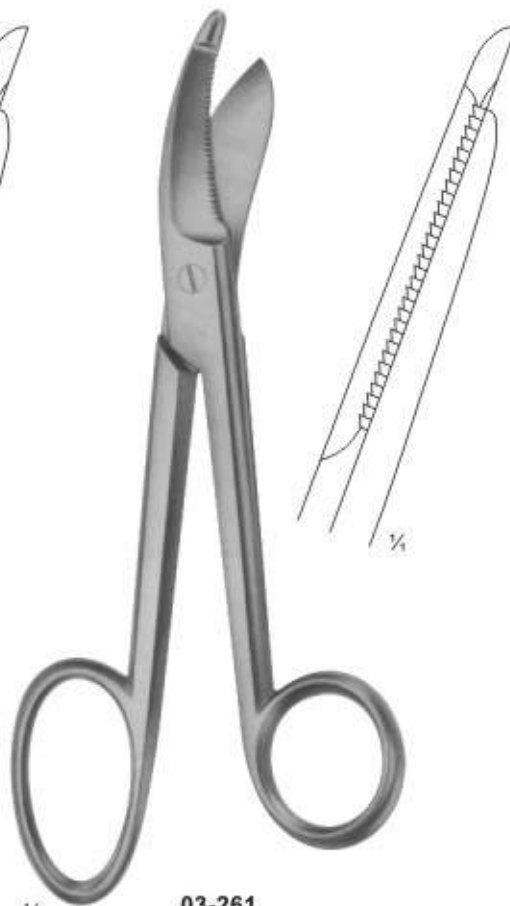

03-261
Bandage Scissors
 235 mm

**Forceps for grasping tissue, tumors etc.
Pinzetten zum Fassen von Gewebe Tumoren usw.**

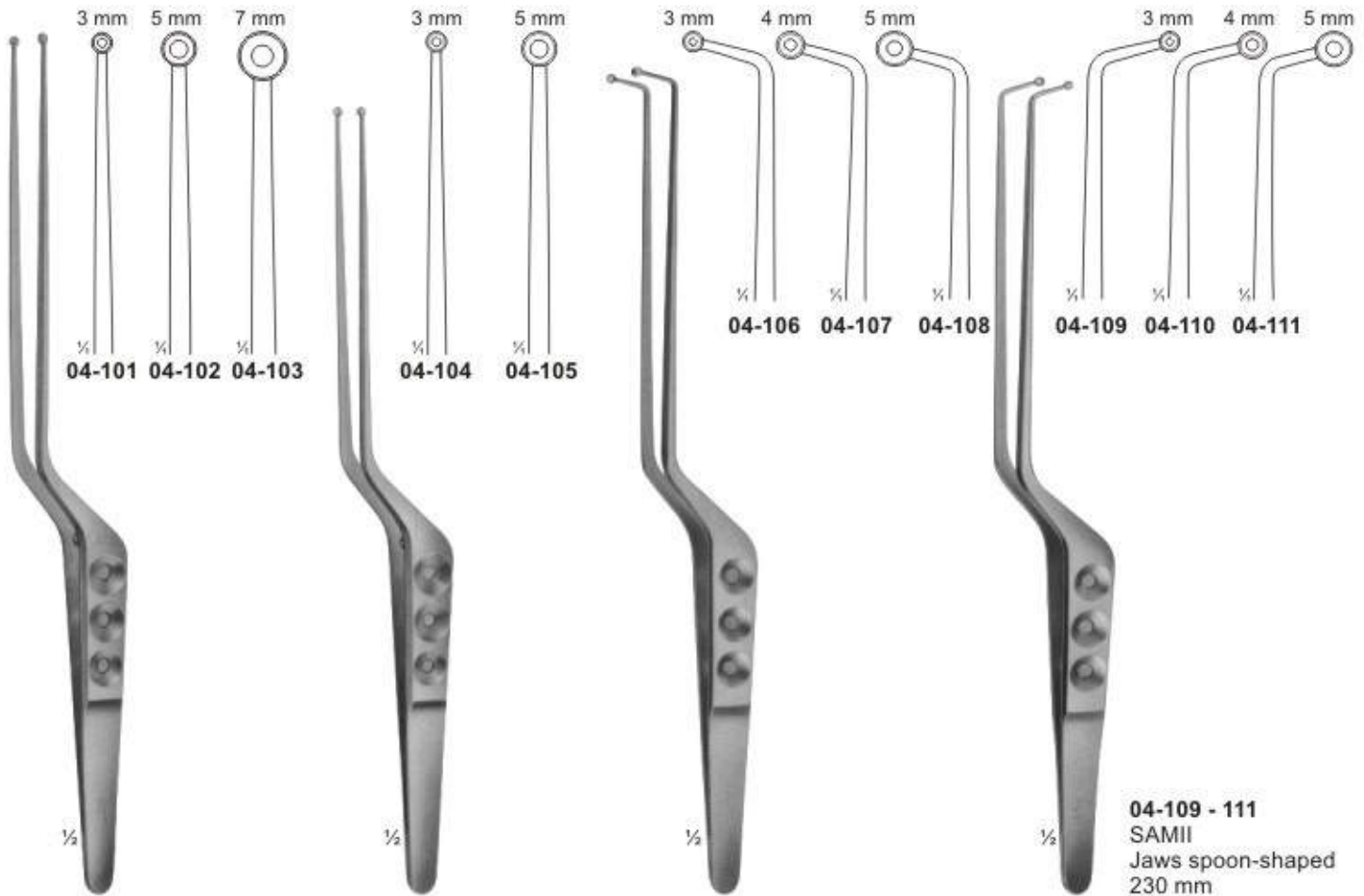

04-101 - 103
YASARGIL-SAMII
Jaws spoon-shaped
240 mm

04-104 - 105
YASARGIL
Jaws spoon-shaped
220 mm

04-106 - 108
SAMII
Jaws spoon-shaped
230 mm

04-109 - 111
SAMII
Jaws spoon-shaped
230 mm



04-112
HUNT
Tumor-and vessel forceps
200 mm



04-113
HUNT
Tumor-and vessel forceps
200 mm



04-114
YASARGIL
Tumor-and vessel forceps
200 mm

Delicate Dissecting, Microscopic, Sterilizing Forceps
Feine anatomische, Mikroskopier, Sterillisierpinzette

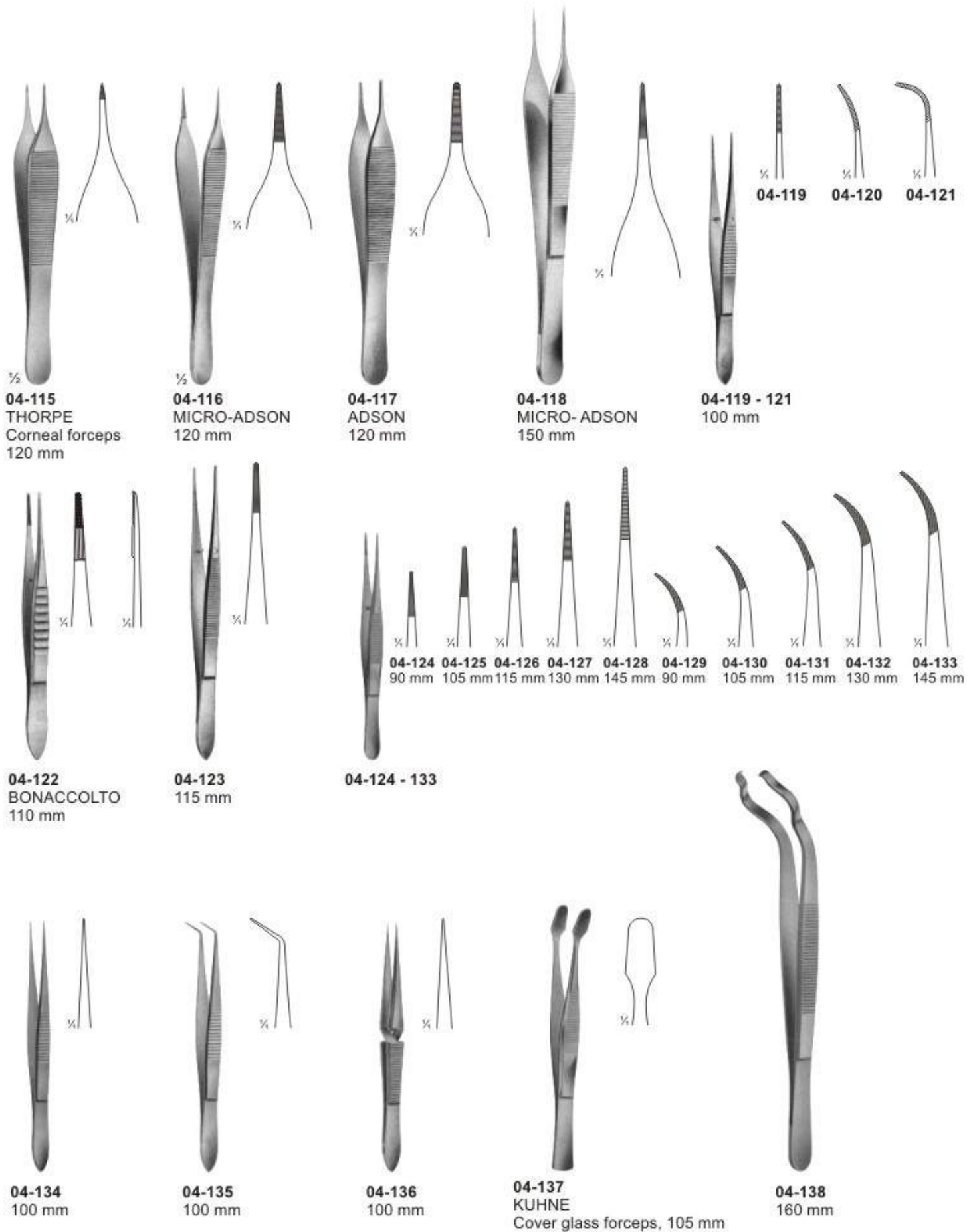

Delicate Dissecting Forceps
Feine anatomische Pinzetten

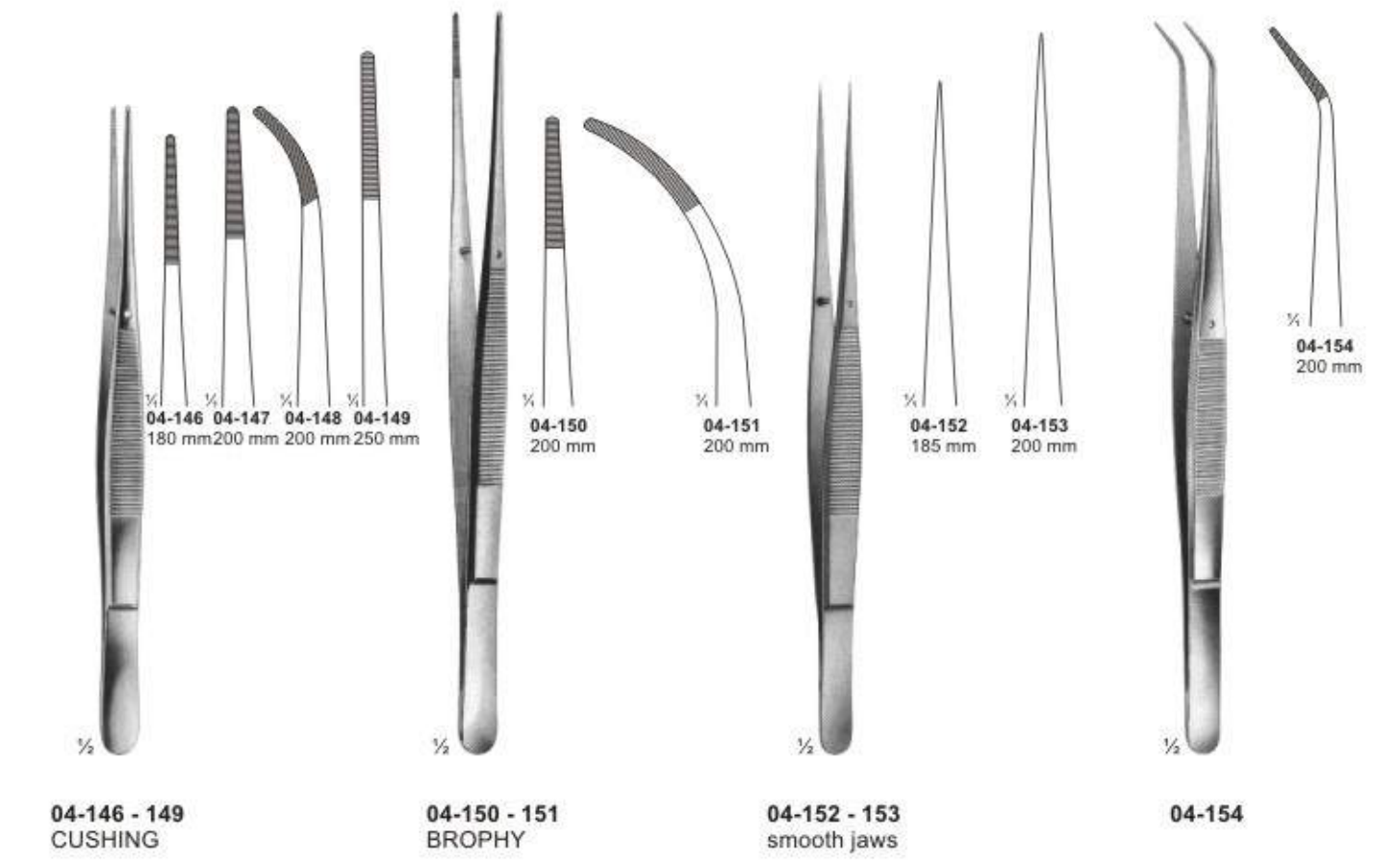
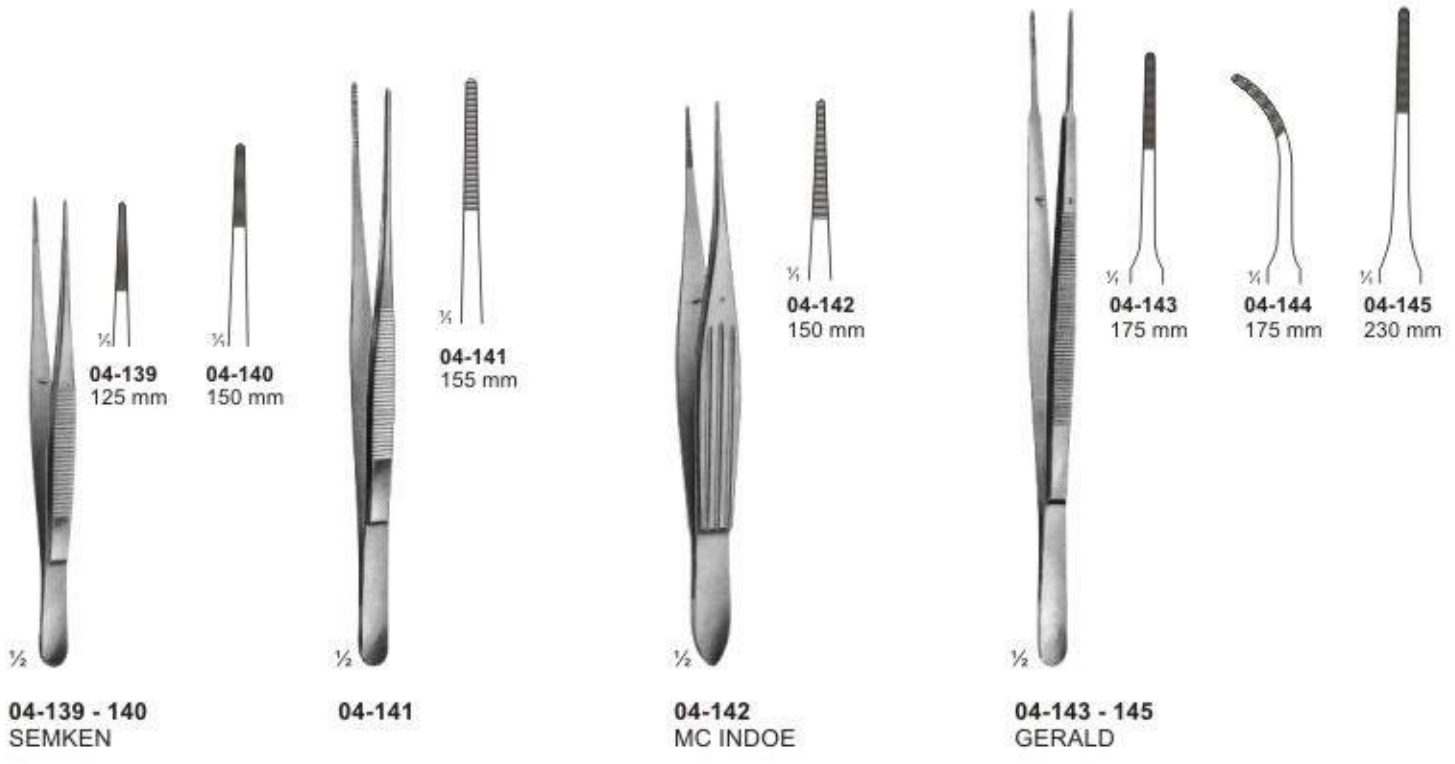

Forceps Pinzetten

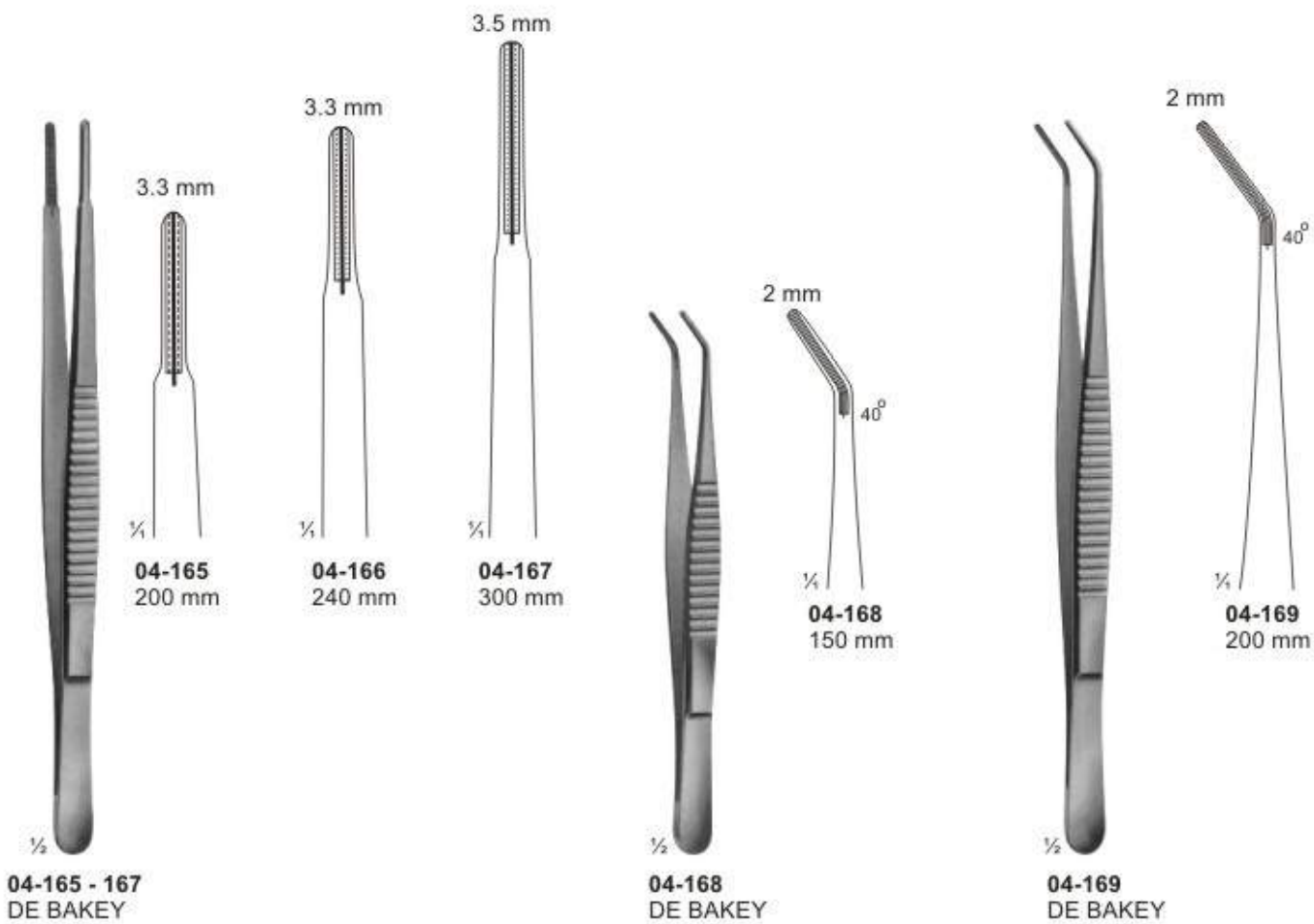
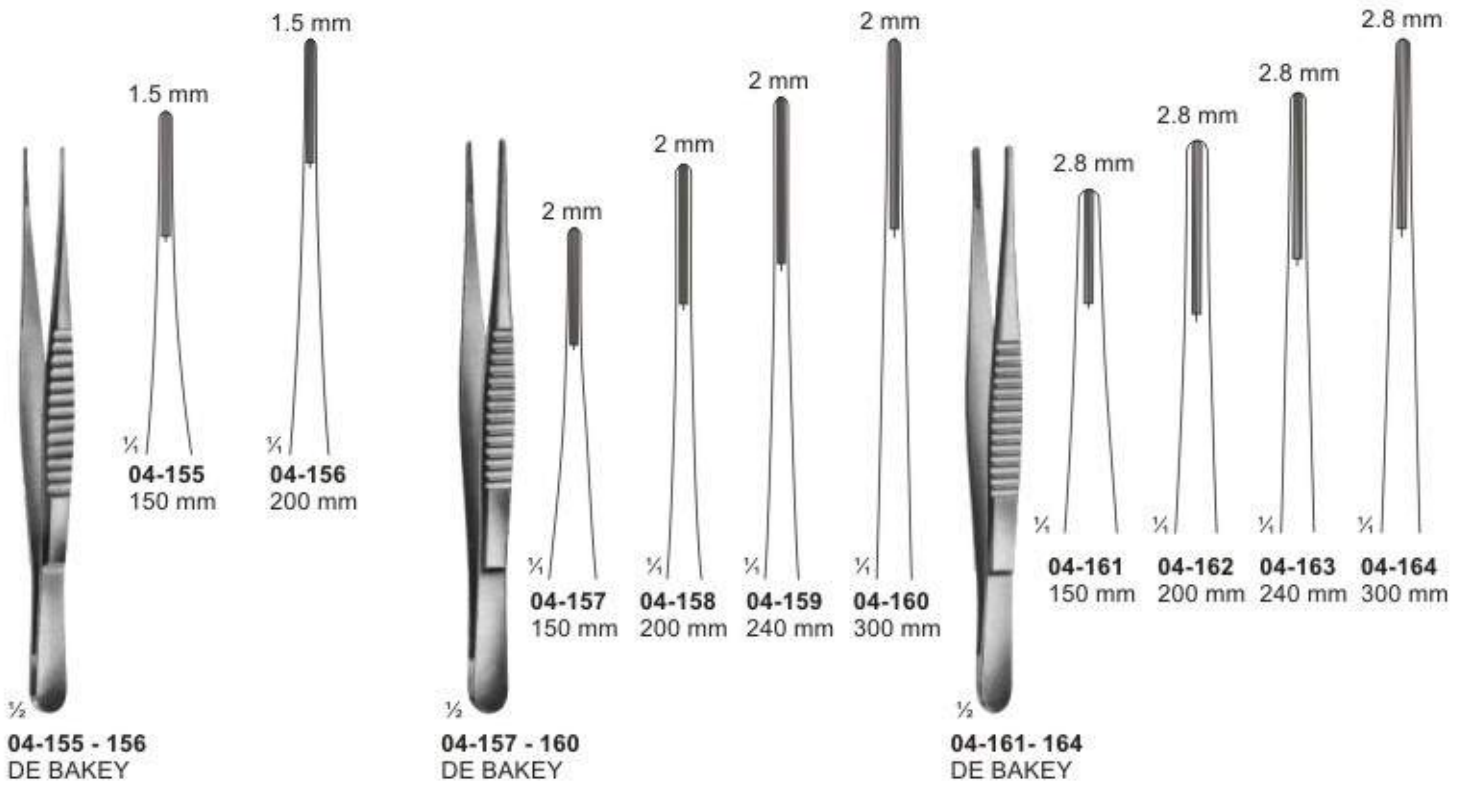

Delicate Tissue Forceps
Feine chirurgische Pinzetten



04-170
BISHOP-HARMON
 85 mm

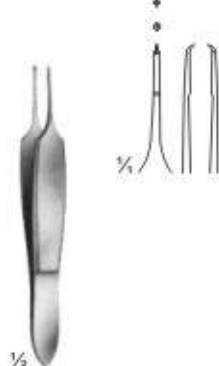

04-171
ST.MARTIN
 80 mm



04-172
CASTROVIEJO
 teeth 0.9 mm
 100 mm

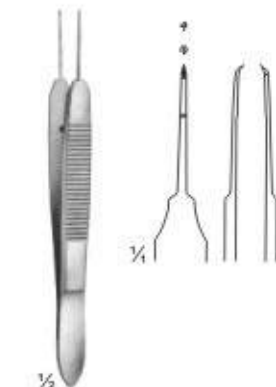

04-173
CASTROVIEJO
 teeth 0.5 mm
 100 mm

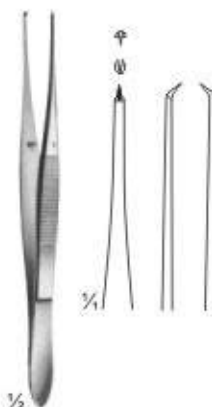

04-174
ELSCHING
 110 mm



04-175
GILL
 75 mm



04-176
GILL - HESS
 75 mm

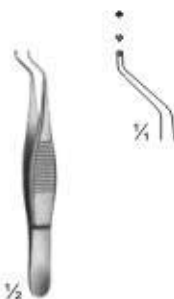

04-177
HESS
 70 mm

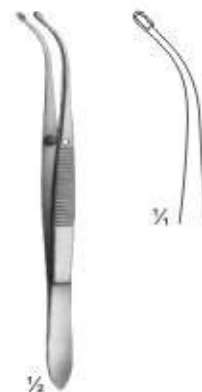

04-178
ARRUGA
 100 mm



04-179
SEMKEN
 125 mm 125 mm 150 mm
 2 X 3 teeth



04-180
MICRO-ADSON
 120 mm

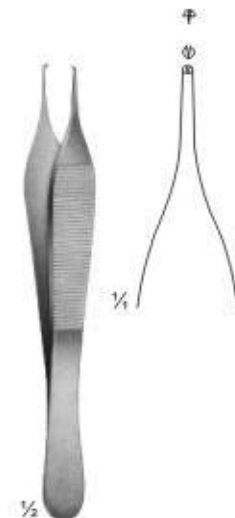

04-181
ADSON
 120 mm



04-182
ADSON
 120 mm



04-183
ADSON
 120 mm



04-184
ADSON
 150 mm

Tissue Forceps, Lung Dissecting Forceps Chirurgische Pinzetten, Lungenfaßpinzetten

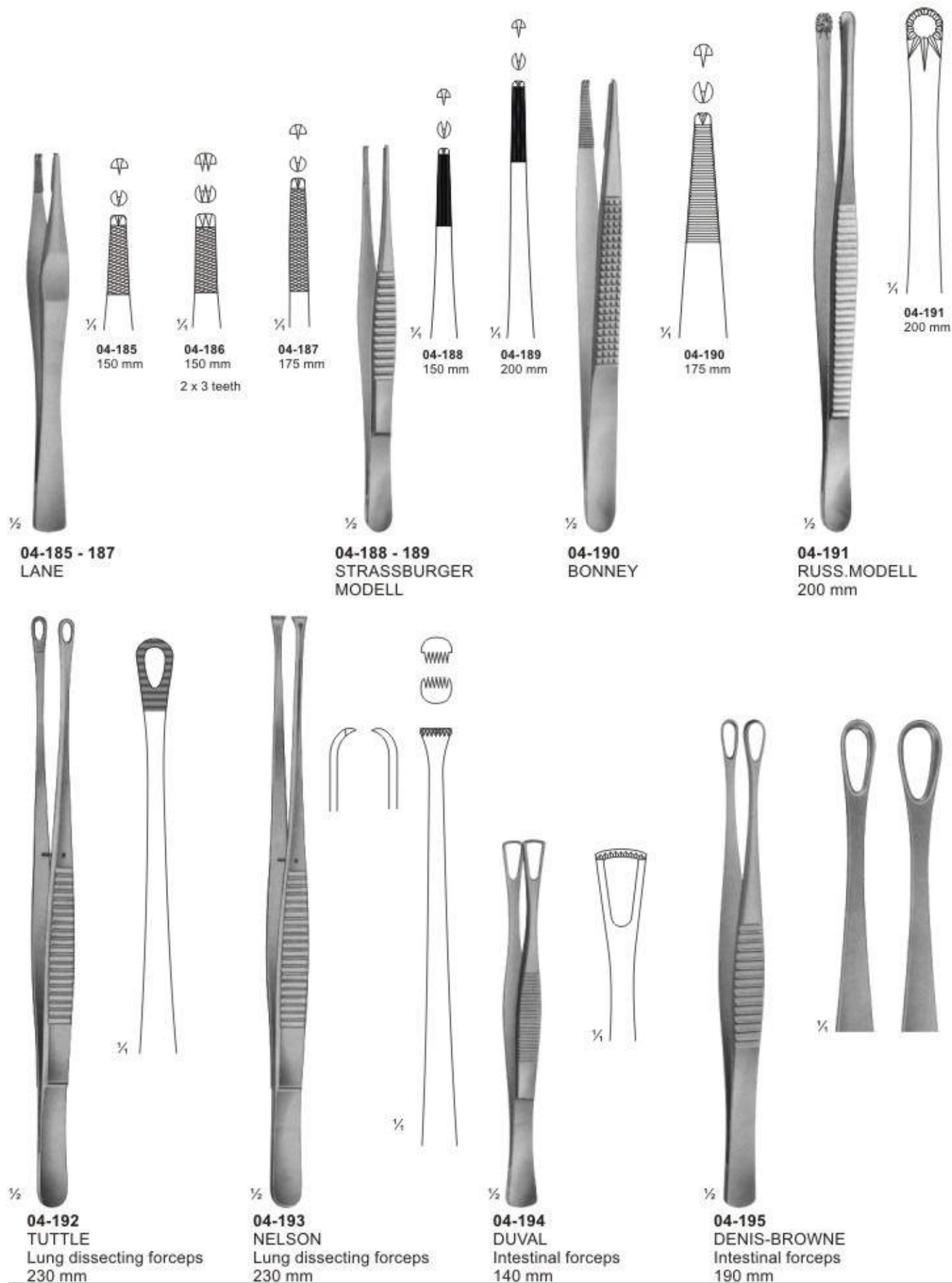

Splinter and Cilia Forceps Splitter und Clienpinzetten

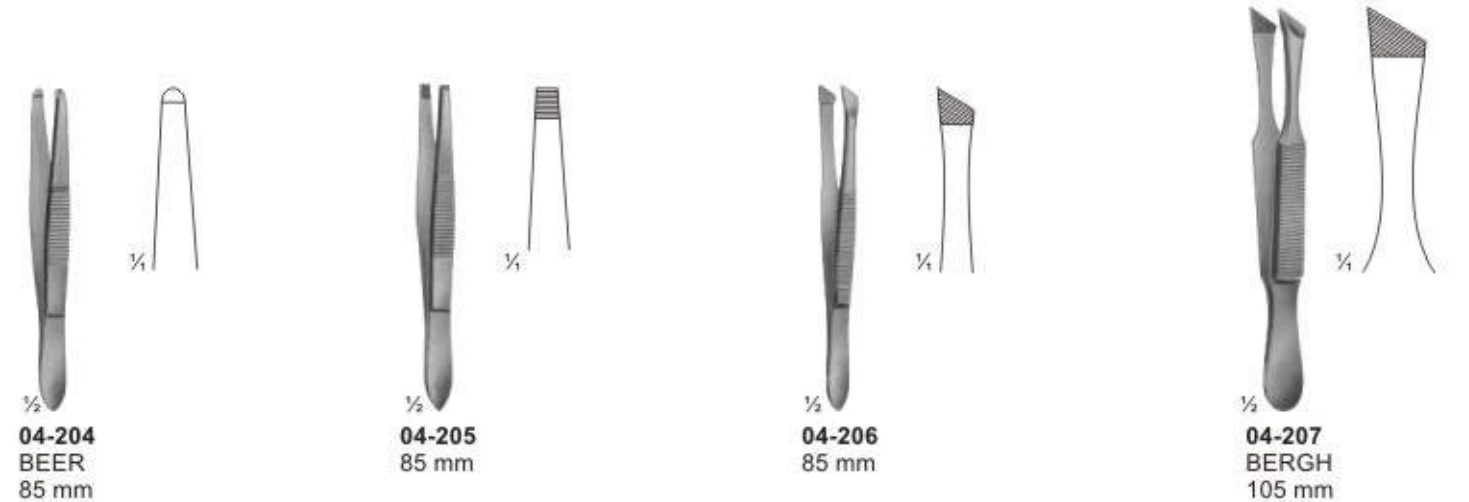

Sponge and Dressing Forceps Kron und Tupferzangen



04-212
BRYANT
130 mm



04-213 - 215
LISTER
Sinus forceps

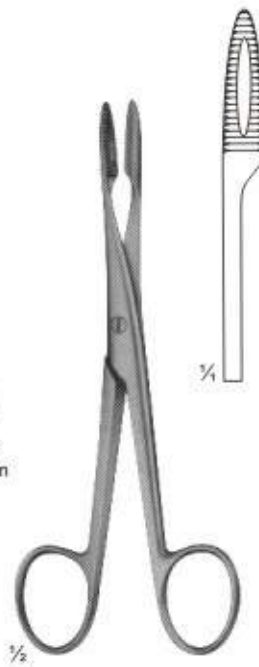

04-216
without ratchet
145 mm

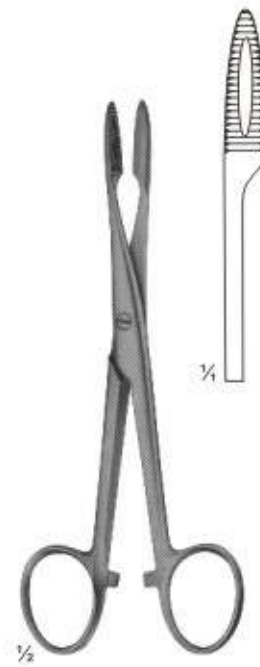

04-217
with ratchet
145 mm

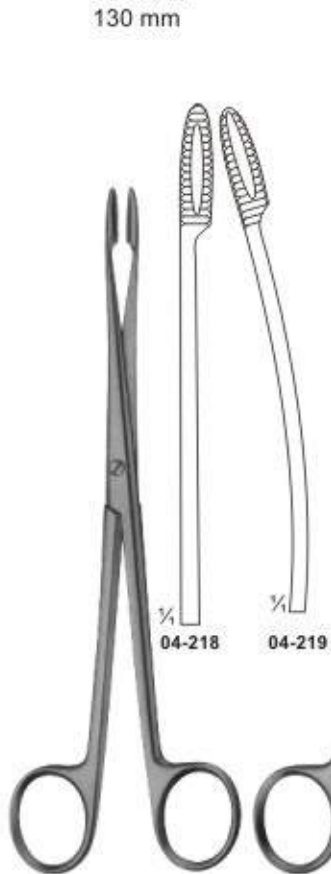

04-218 - 219
GROSS
without ratchet
180 mm

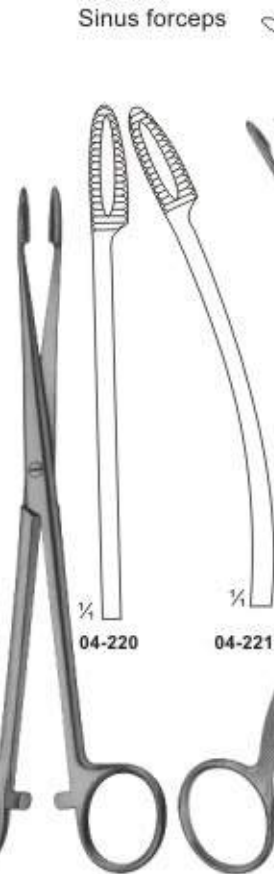

04-220 - 221
GROSS
with ratchet
180 mm

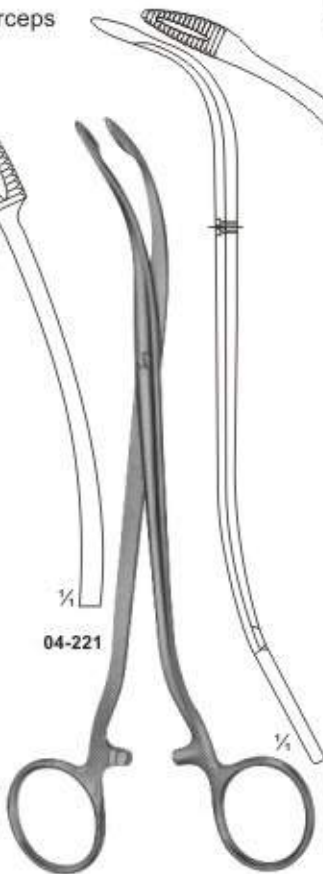

04-222
DUPLAY
190 mm

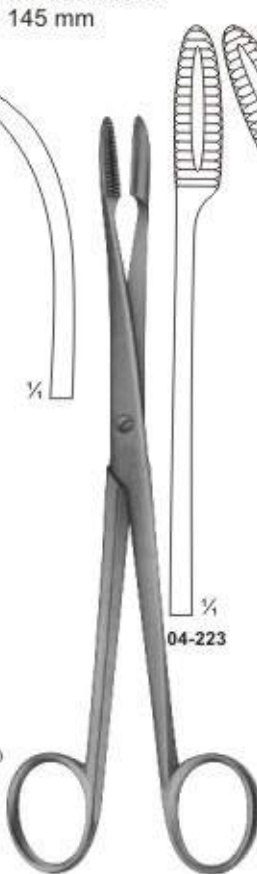

04-223 - 224
GROSS
without ratchet
200 mm

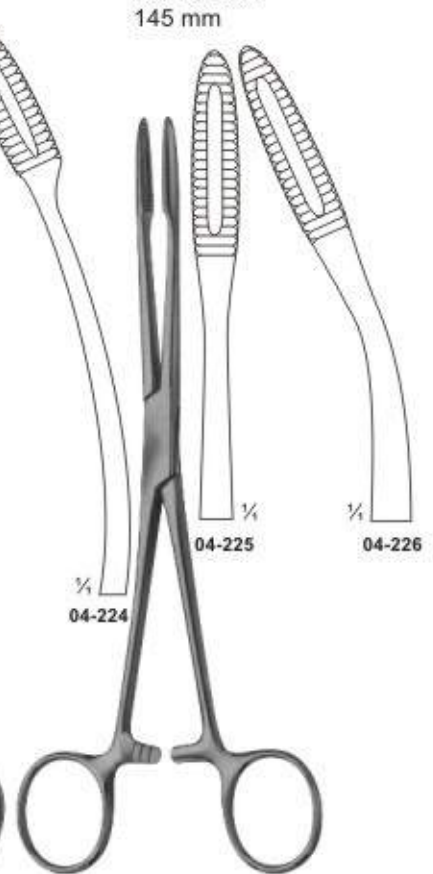

04-225 - 226
GROSS
with ratchet
200 mm

Dressing-, Sponge holding-, Organ- and Tissue
Grasping Forceps
Tupfer-, Schwamm-, Organ- und Gewebefaßzangen

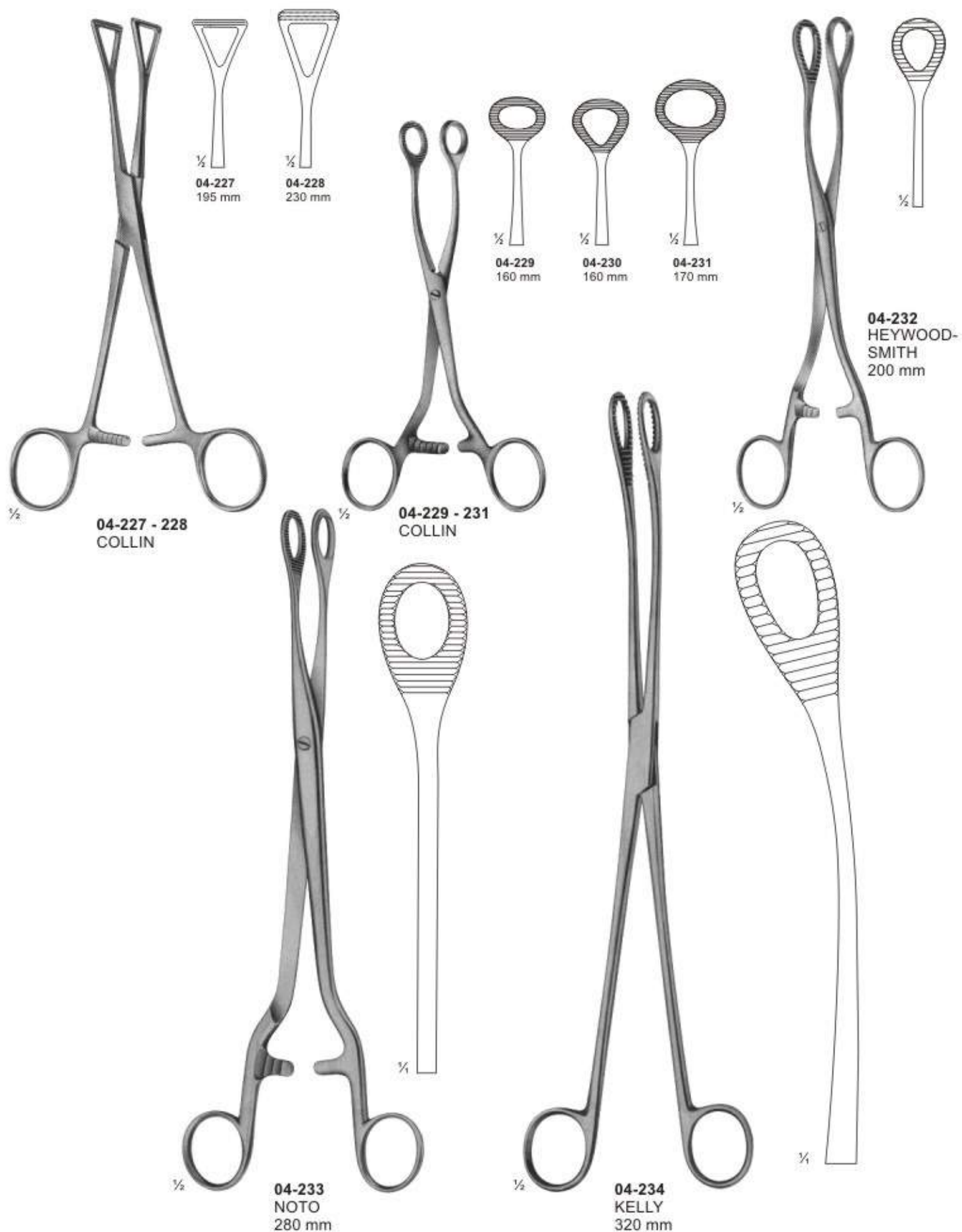

**Artery Traction - and Tissue Grasping Forceps
Arterien- und Gewebefazangen**

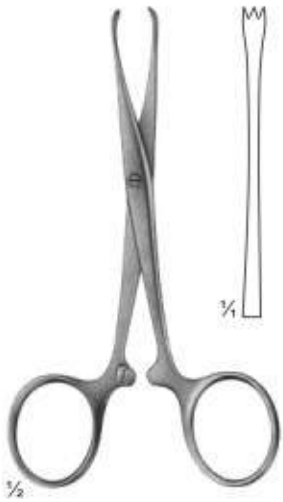

04-235
CHAPUT
2 x 3 teeth
125 mm

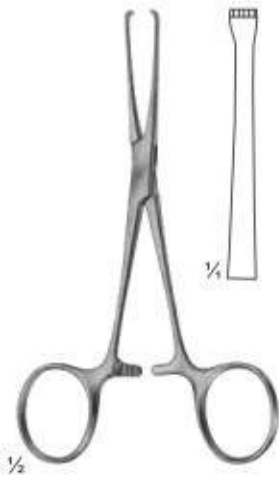

04-236
BABY-ALLIS
4 x 5 teeth
130 mm

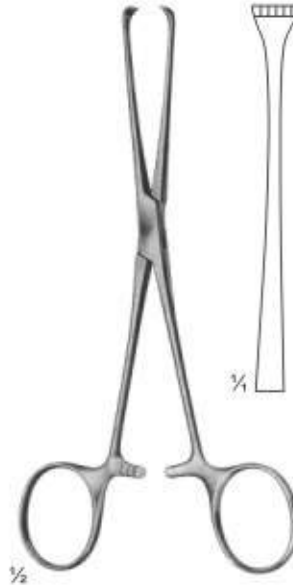

04-237
BOYS-ALLIS
5 x 6 teeth sharp
155 mm

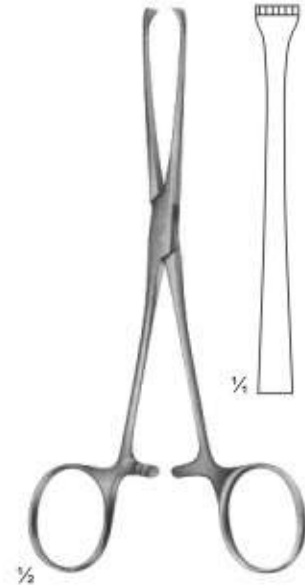

04-238
ALLIS
5 x 6 teeth
155 mm



04-239
LAHEY
155 mm

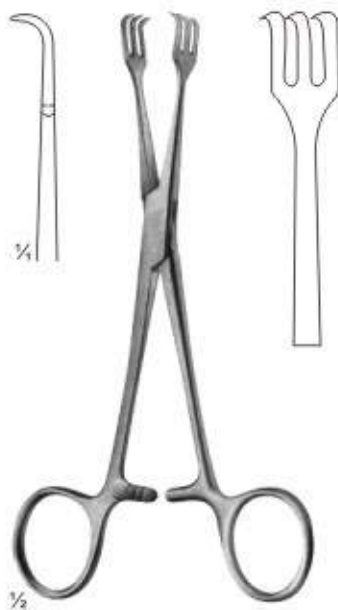

04-240
LAHEY
155 mm

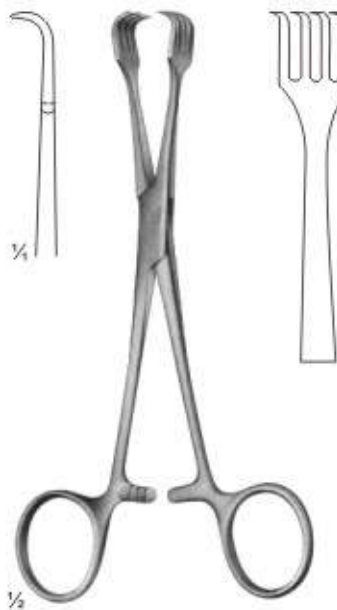

04-241
BRAUN
155 mm

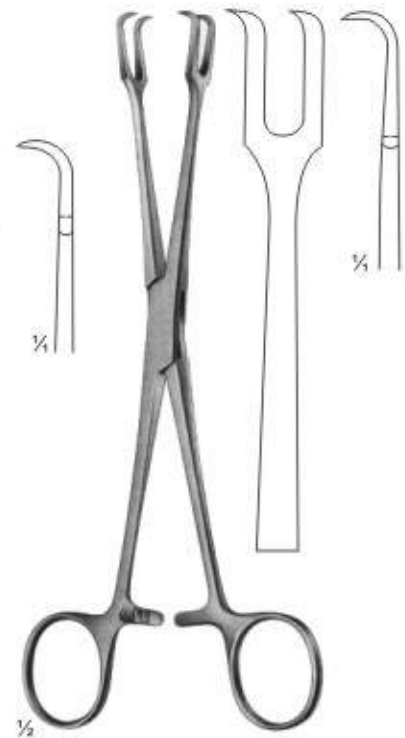

04-242
MUSEUX
200 mm

**Towel Clamps
Tuchklemmen**

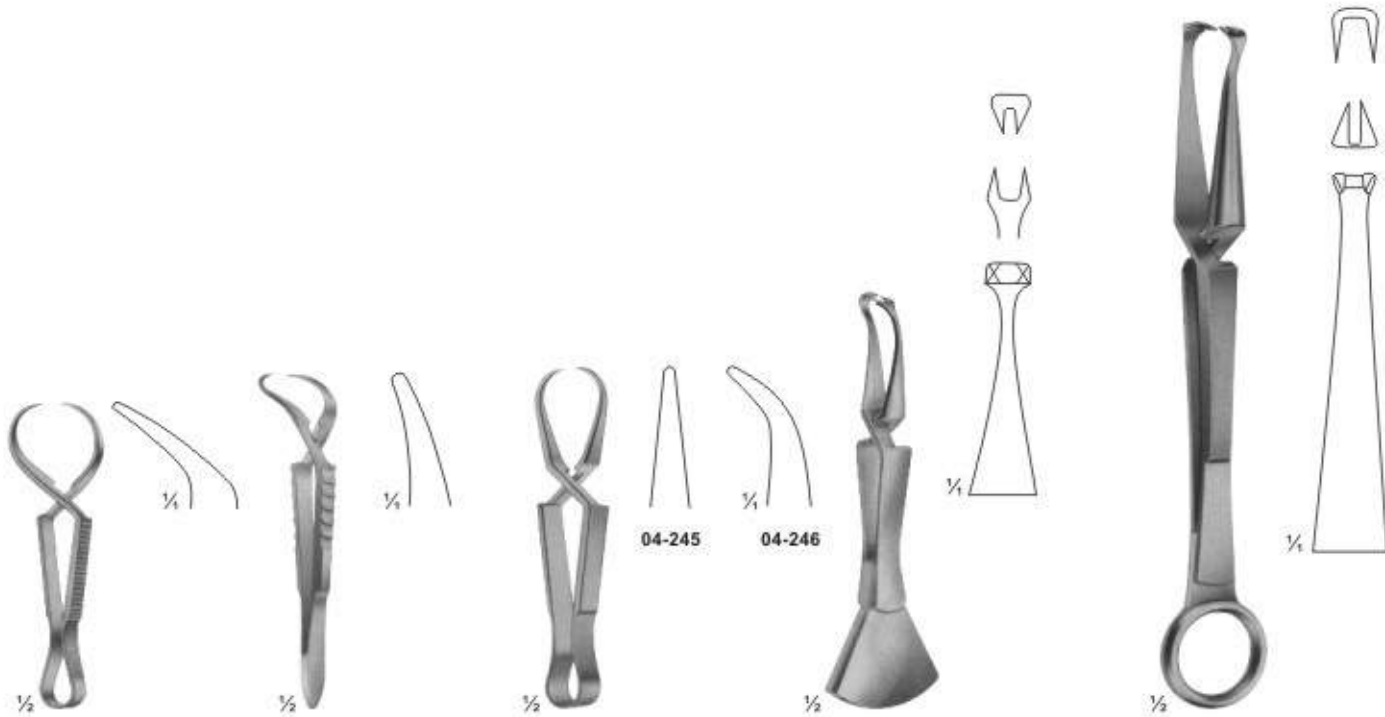

04-243
JONES
85 mm

04 - 244
ENGL. MOD.
85 mm

04 245 - 246
SCHAEDEL
85 mm

04-247
DOYEN
110 mm

04-248
DOYEN
180 mm

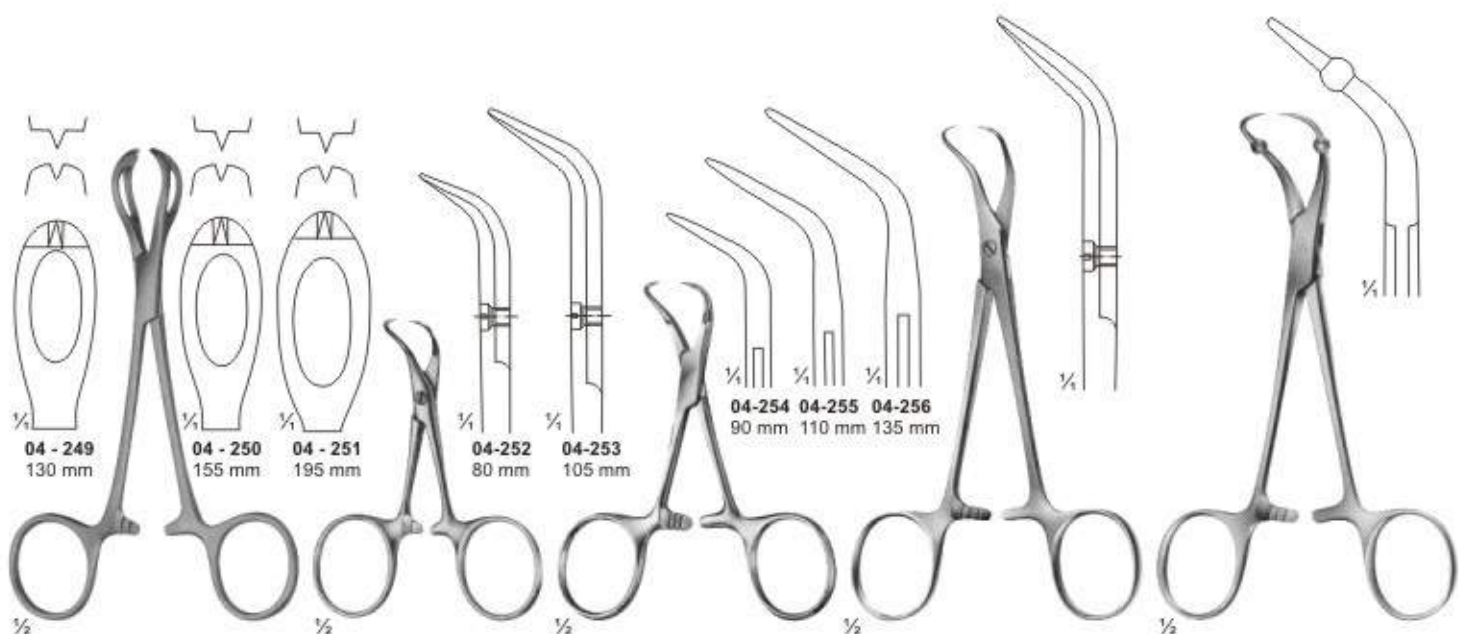

04 - 249
130 mm

04 - 250
155 mm

04 - 251
195 mm

04-252
80 mm

04-253
105 mm

04-254 04-255 04-256
90 mm 110 mm 135 mm

04-249 - 251
LANE

04-252 - 253
BACKHAUS

04-254 - 256
BACKHAUS

04-257
BACKHAUS-KOCHER
135 mm







04-258
ROEDER
135 mm













Muller Vessel Clips and Bulldog Clamps











GefaBclips nach MULLER und Bulldogklemmen



Closing force

						
04-259 straight	04-260 curved	04-261 curved tips	04-262 angled shaped	04-263 MULLER knee-bent	04-264 Muller Ligature Forceps	Jaw, cross serrated
80g 50g	80g 50g	80g 50g	80g 50g	80g 50g	80g 50g	

											
04-265	04-266	04-267	04-268	04-269	04-270	04-271	04-272	04-273	04-274	04-275 - 281	04-282
35 mm	35 mm	45 mm	45 mm	38 mm	48 mm	38 mm	48 mm	58 mm	58 mm	91 mm	20 mm

									
04-283	04-284	04-285	04-286	04-287	04-288	04-289	04-293	04-297	04-300
length 50 mm jaws 27 mm	length 48 mm jaws 27 mm	GLOVER length 57 mm jaws 35 mm	DE BAKEY length 73 mm jaws 38 mm	DE BAKEY length 99 mm jaws 63 mm	DE BAKEY length 95 mm jaws 54 mm	L. 80 mm L. 90 mm L. 105 mm L. 124 mm	L. 78 mm L. 86 mm L. 97 mm L. 114 mm	GLOVER L. 68 mm L. 96 mm L. 117 mm	GLOVER L. 65 mm L. 91 mm L. 110 mm

**Delicate Haemostatic Forceps
Feine Arterienklemmen**

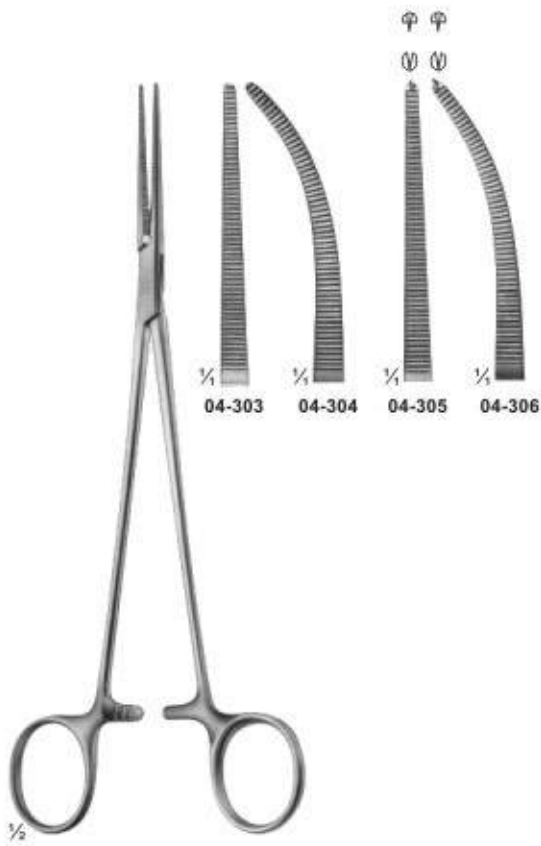

04-303 - 306
HALSTED-MOSQUITO
200 mm

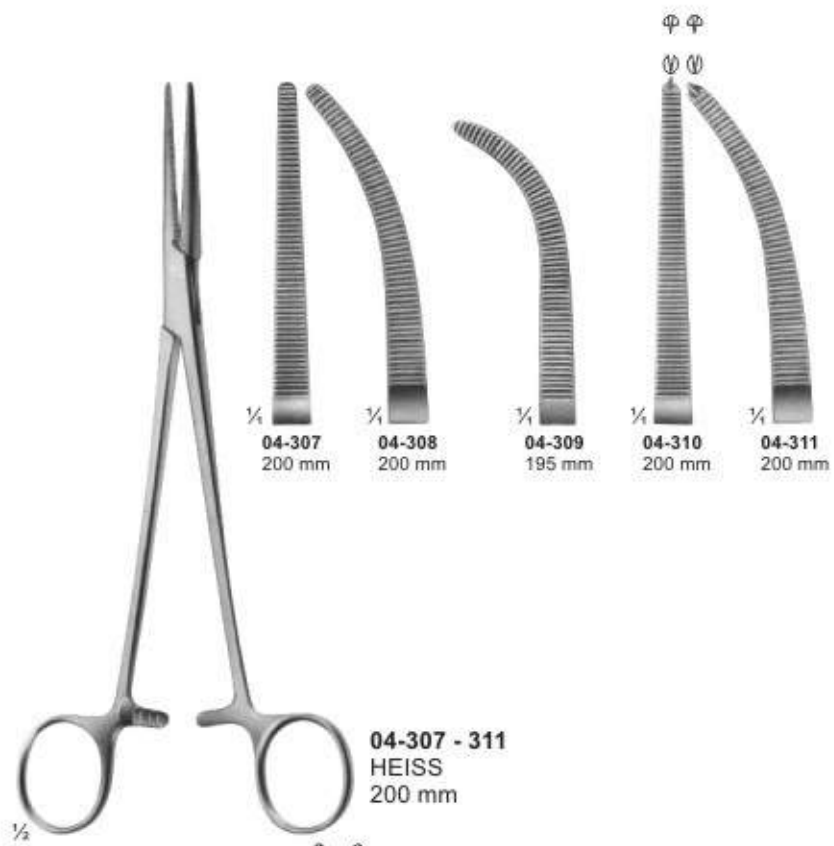

04-307 - 311
HEISS
200 mm



04-312 - 313
HALSTED
215 mm

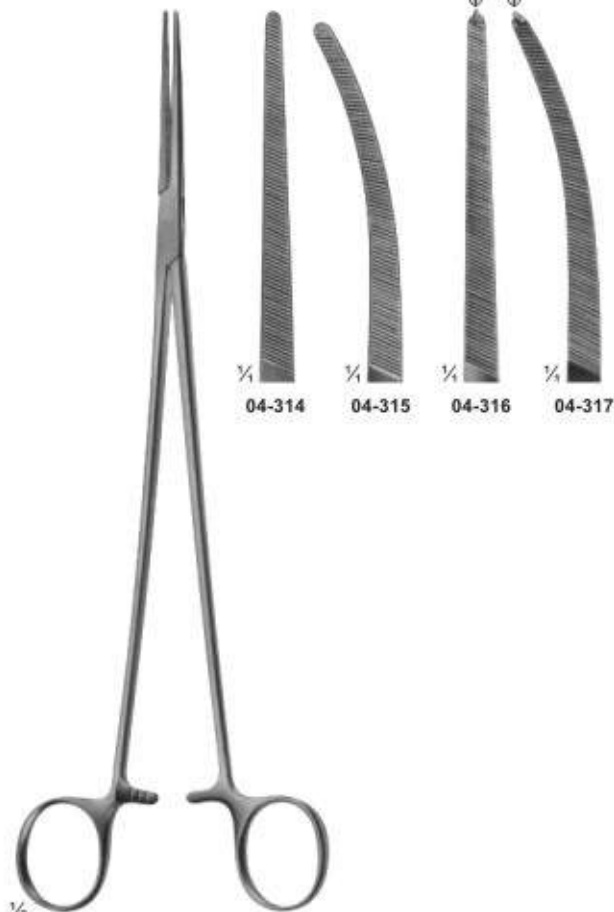

04-314 - 317
BENGOLEA
245 mm



04-318
CRAFOORD
245 mm

Haemostatic Forceps Arterienklemmen

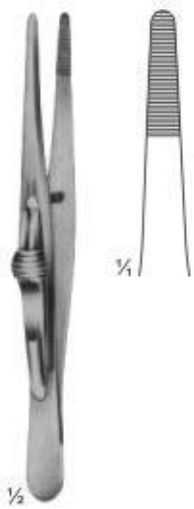

04-319
FRICKE
Artery forceps
130 mm



04-320
KRONLEIN
130 mm

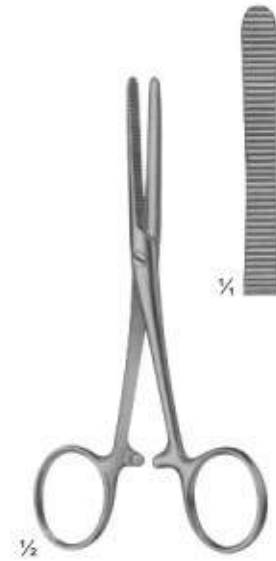

04-321
PEAN
125 mm



04-322 - 323
PEAN

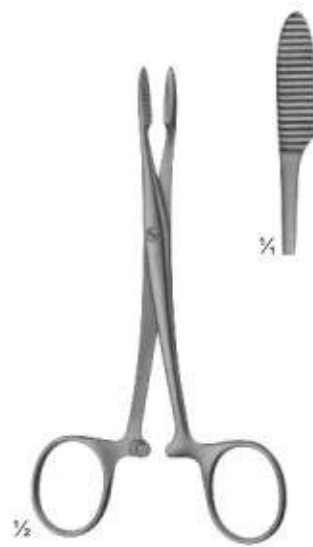

04-324
PEAN
125 mm



04-325 - 326
PEAN

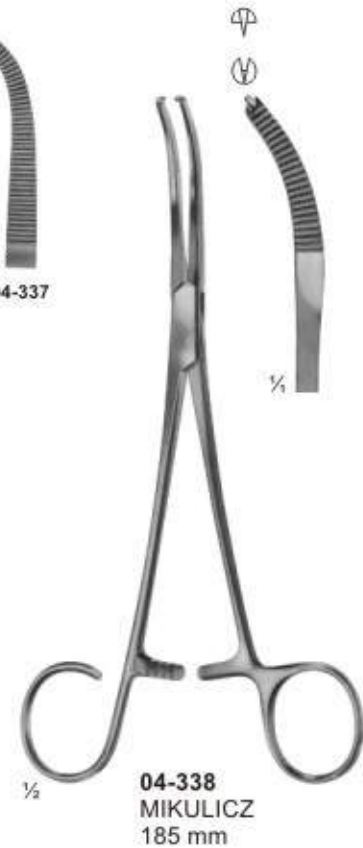
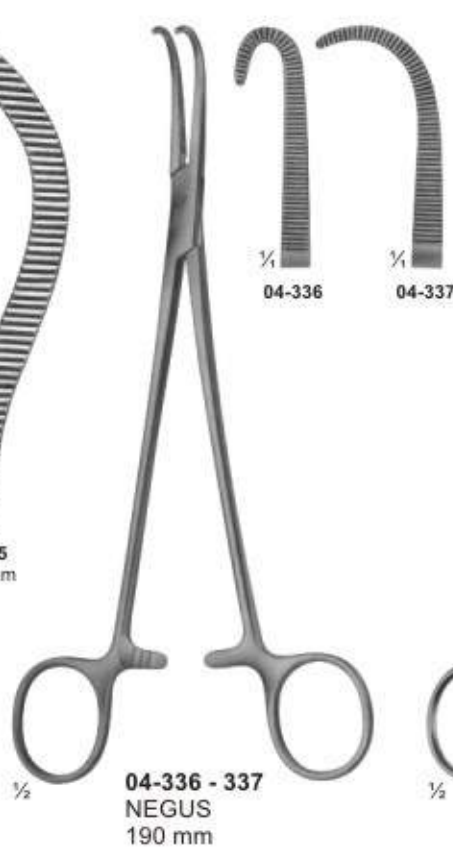
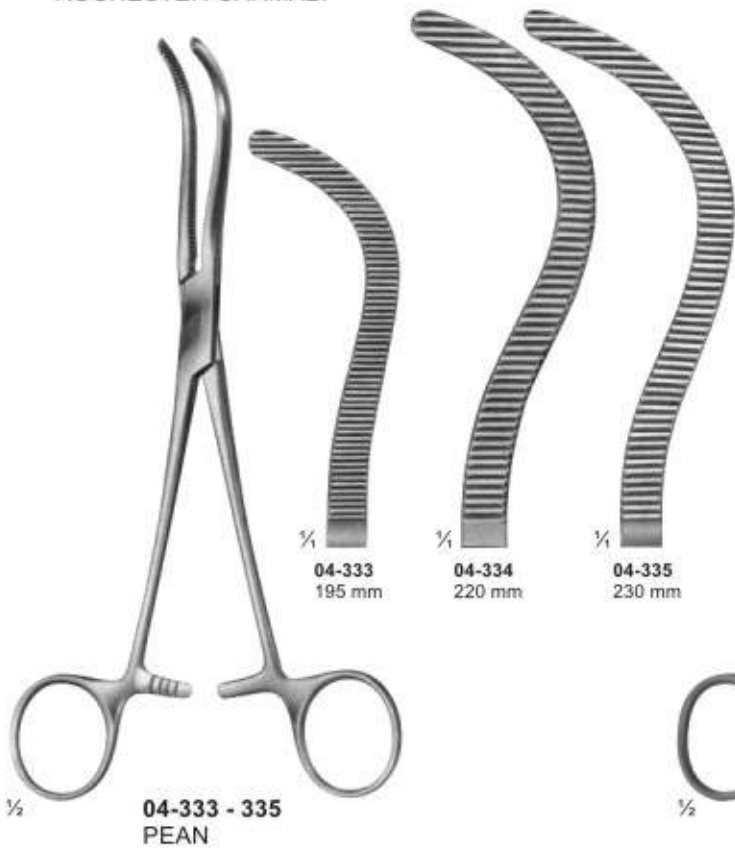
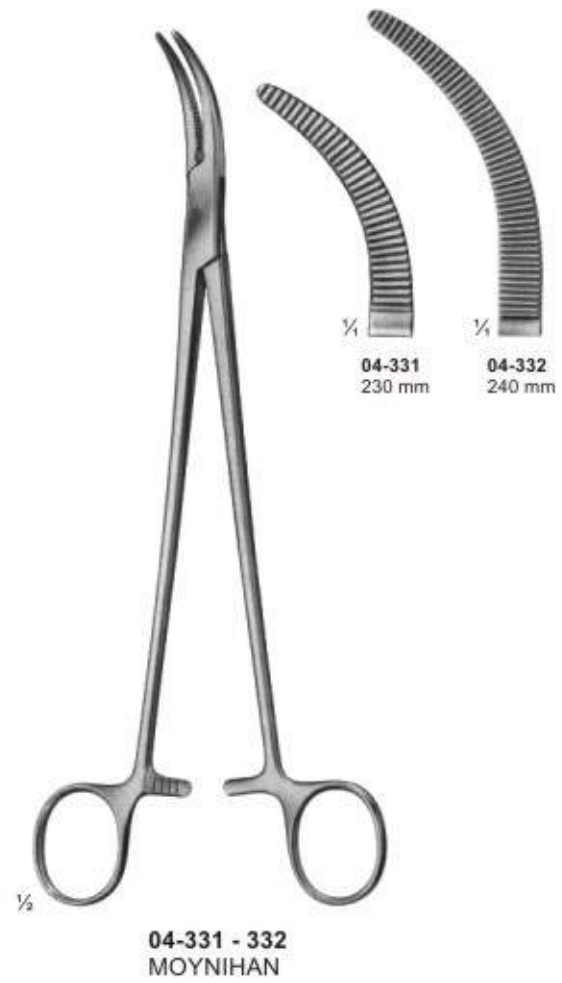
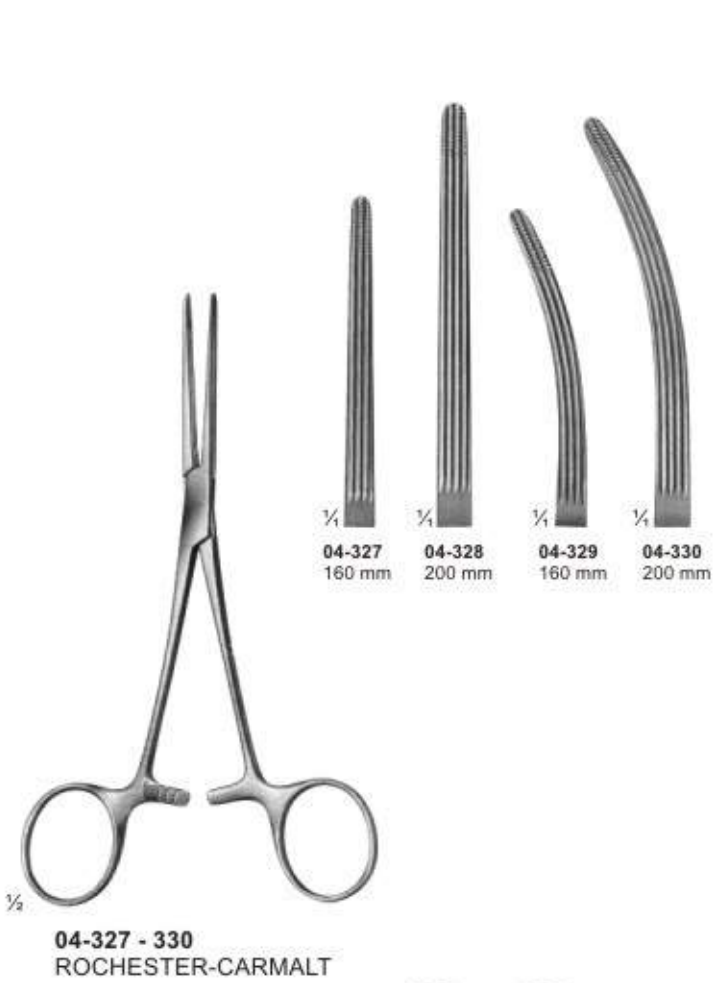

Dissecting- and Ligature Forceps
 Präparier- und Ligaturklemmen



04-339
 MIXTER-O'SHAUGNESSY
 190 mm



04-340
 HEISS
 195 mm

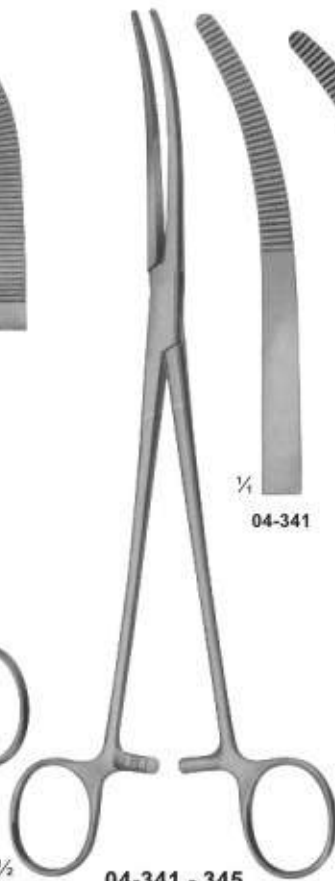

04-341 - 345
 RUMEL
 240 mm

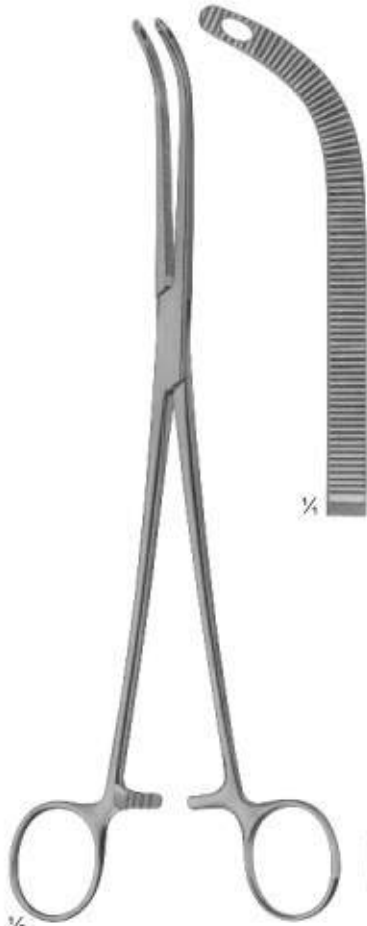
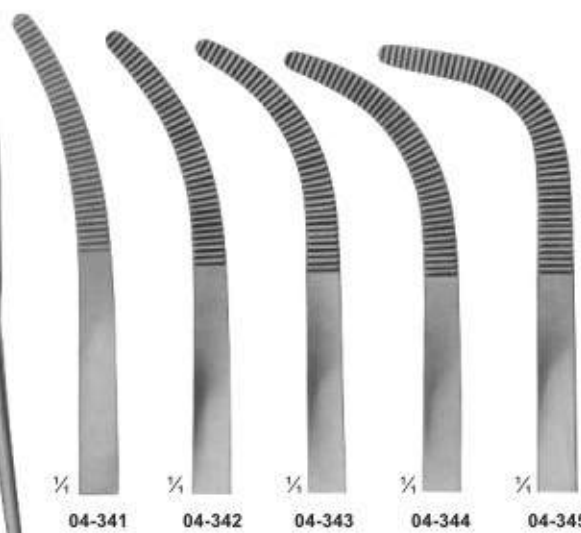

04-346
 FINOCHIETTO
 245 mm



04-347
 MIXTER
 230 mm



04-348
 LAWRENCE
 270 mm



04-349 - 350
 ZENKER



Hysterectomy Forceps, Vaginal Clamps
and Compression Forceps
Hysterektomie, Vaginalklemmen und klemmzangen



04-351
WERTHEIM
Hysterectomy forceps
255 mm

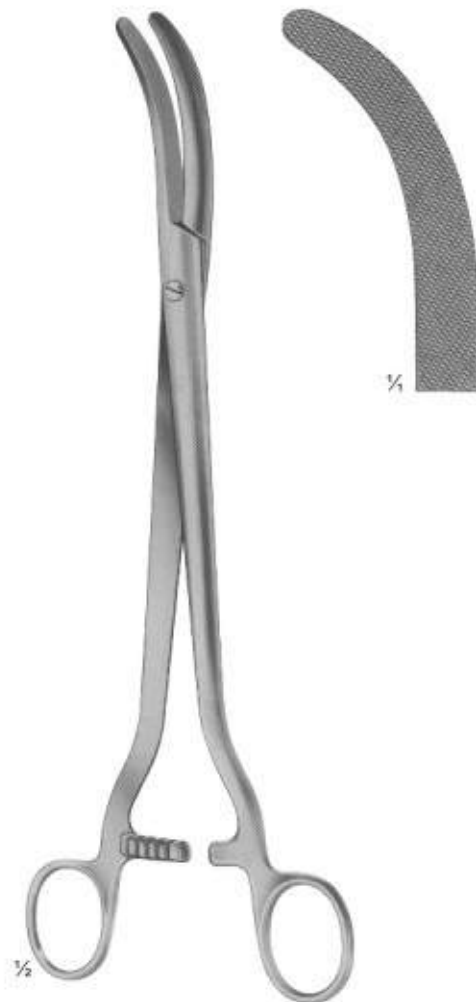

04-352
WERTHEIM
Parametrium clamp
260 mm



04-353 - 355
DICK



04-353 255 mm 04-354 265 mm 04-355 275 mm

Hysterectomy Forceps, Vaginal Clamps
and Compression Forceps
Hysterektomie, Vaginalklemmen und Klemmzangen



Needle Holders for micro surgery
Nadelhalter für Mikorchirurgie



05-101
ROHRSCHEIDER
 with copper inserts
 100 mm



05-102
KALT
 with catch
 135 mm



05-103
ARRUGA
 with catch
 135 mm



05-104 - 105
CASTROVIEJO
 with catch
 145 mm



05-106 - 107
 without Catch
 160 mm



05-108 - 109
 without catch
 185 mm

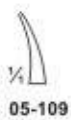

05-109



05-110 - 111
JACOBSON
 with catch
 185 mm

05-110
 without catch

05-111
 with catch



05-112
 without catch
 195 mm



05-113 - 114
YASARGIL
 with catch
 200 mm

05-113

05-114

Needle Holders
Nadelhalter



Needle Holders
Nadelhalter

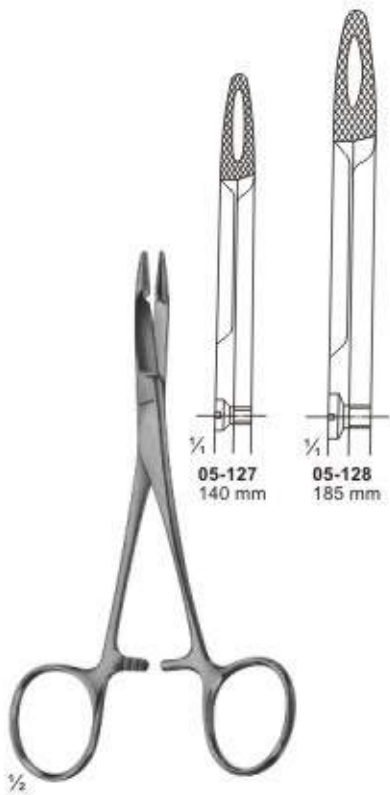

05-127 - 128
HEGAR-OLSEN
255 mm

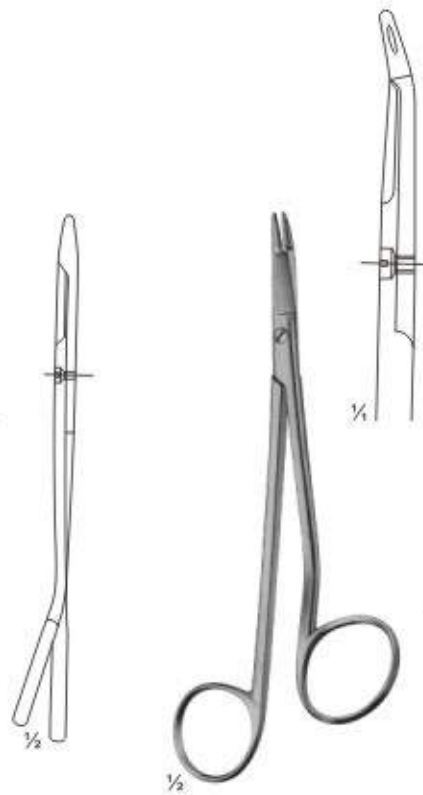

05-129
GILLIES
150 mm

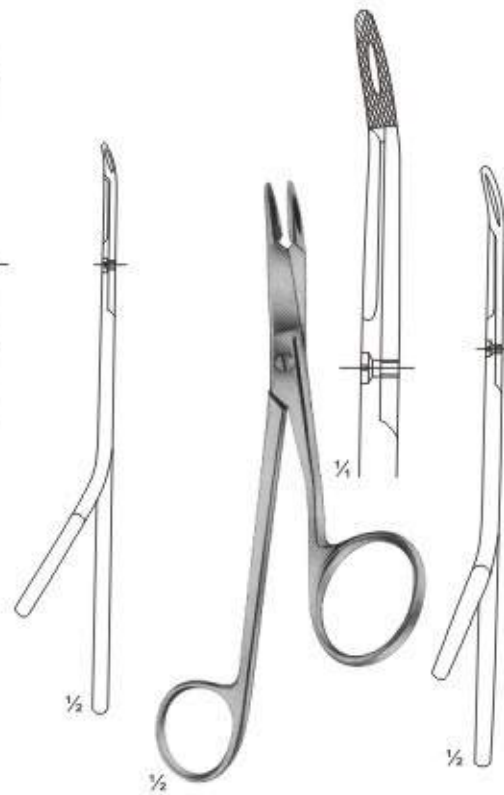

05-130
GILLIES
160 mm

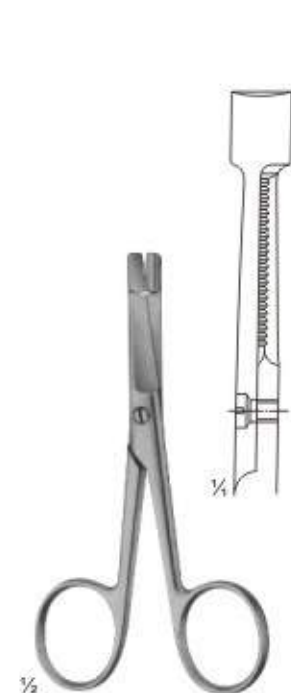

05-131
EISELSBERG
115 mm

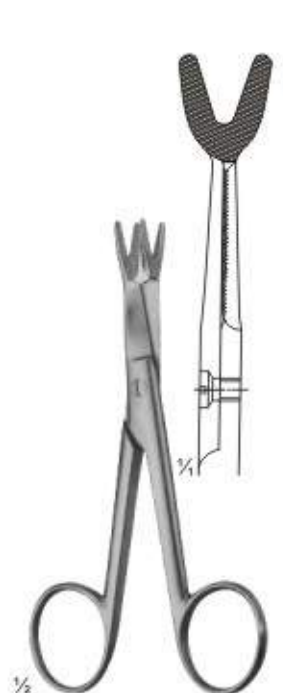

05-132
SCHOEMAKER-LOTH
125 mm



05-133
CRILE
150 mm



05-134
TOENNIS
Elastic pattern for
dura-or intestinal suture
180 mm

Suture Instruments - Reverdin Needles
Naht-Instrumente-Reverdin-Nadeln

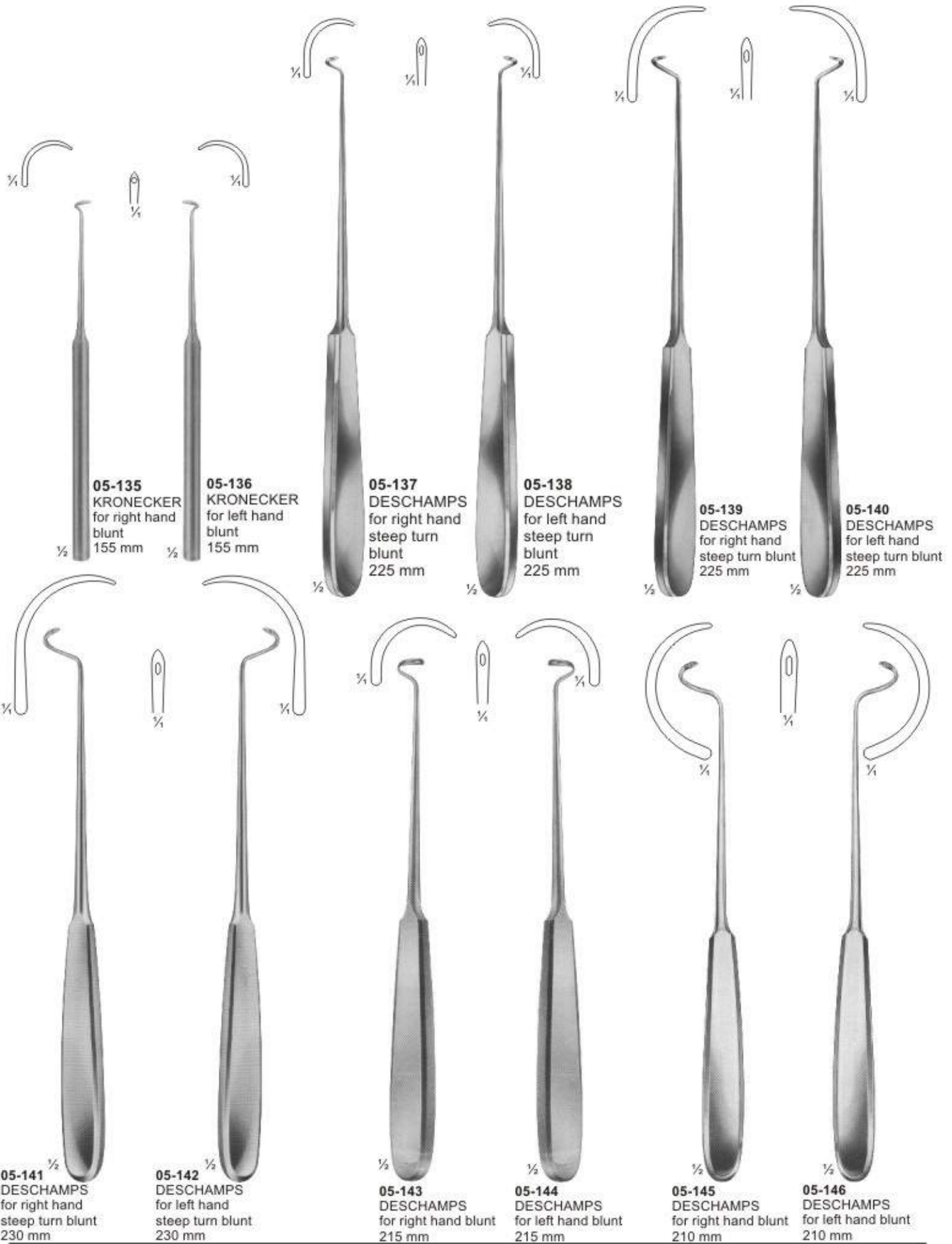

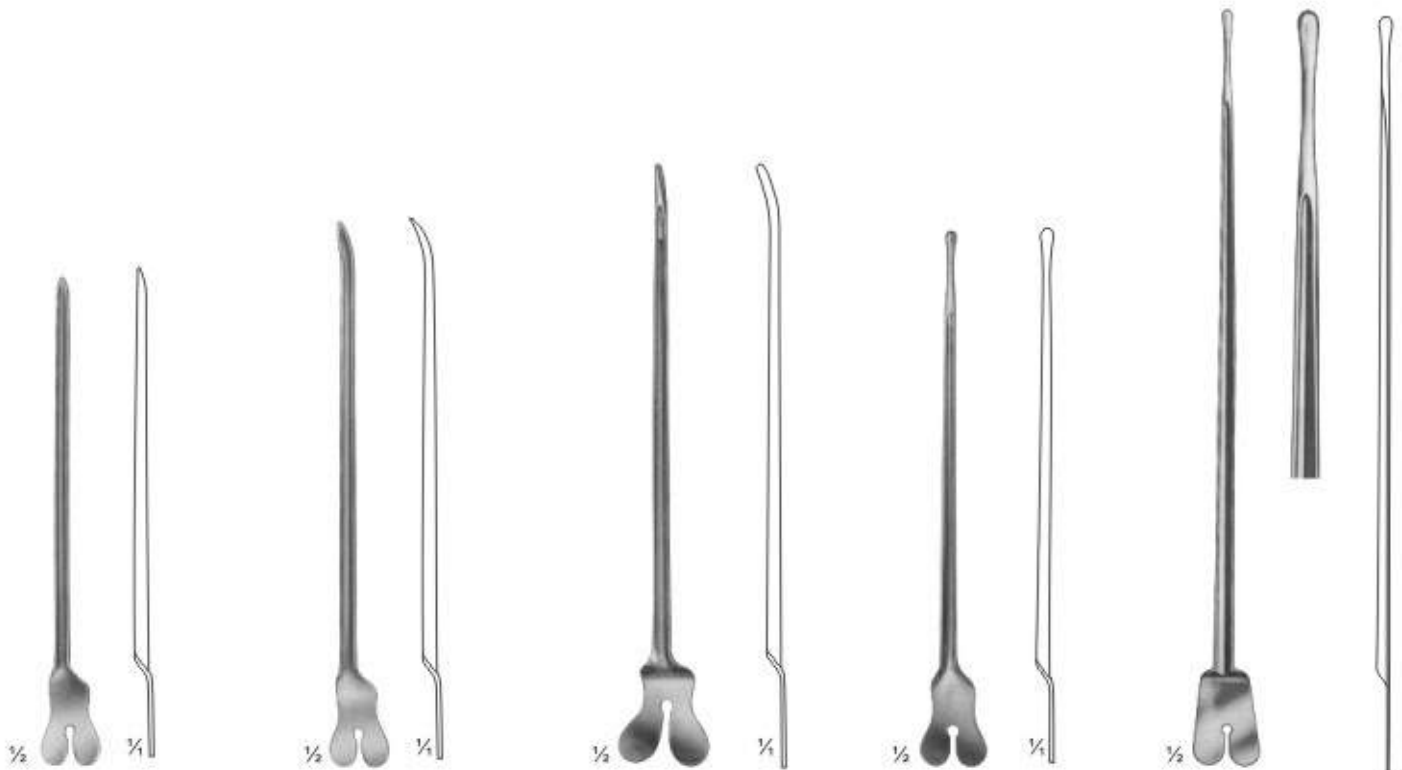

05-147 130 mm
05-148 145 mm
05-149 160 mm
Directors

05-150
DOYEN
145 mm
Directors

05-151
NELATON
160 mm
Directors

05-152
Director with tip
Diam. Of tip 3,3 mm
140 mm

05-153
BRODIE
Director with tip,
Diam. Of tip 3,5 mm
200 mm

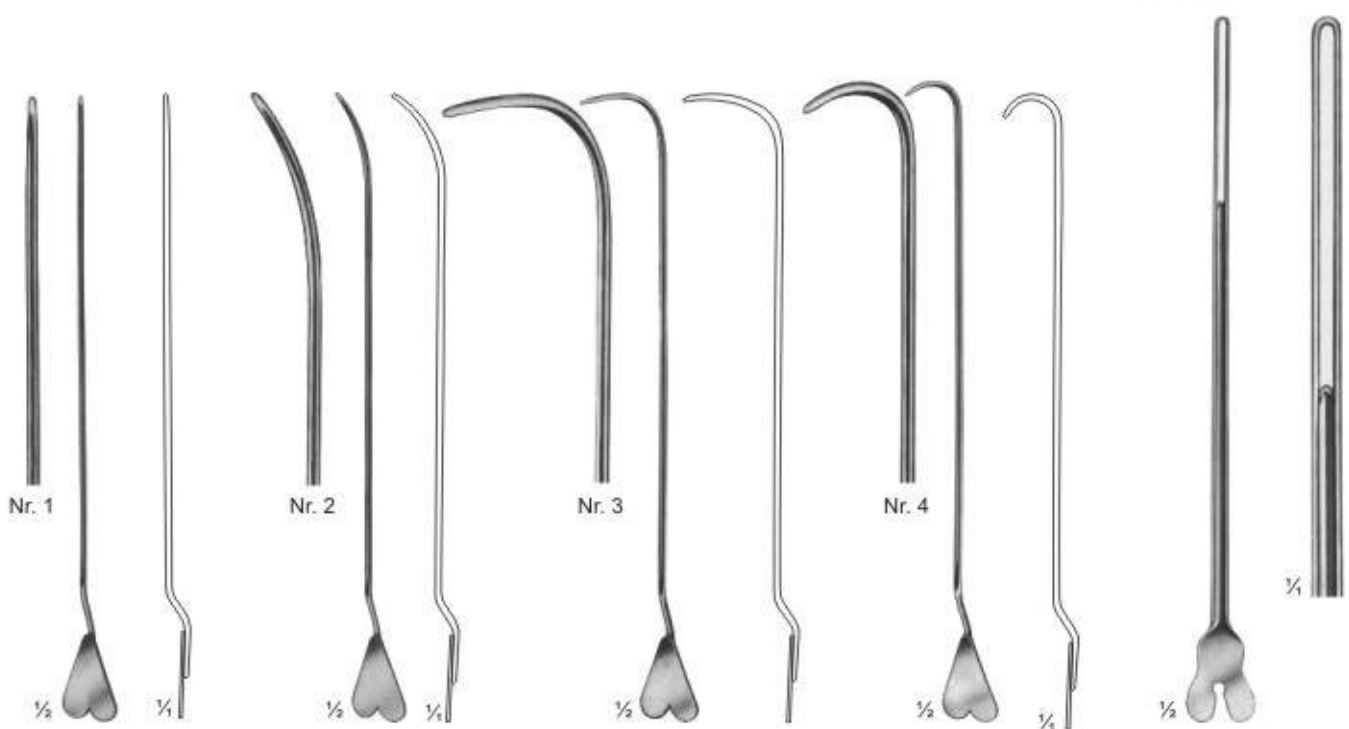

05-154
LOCKHART-MUMMERY
165 mm

05-155
LOCKHART-MUMMERY
165 mm

05-156
LOCKHART-MUMMERY
165 mm

05-157
LOCKHART-MUMMERY
165 mm

05-158
Director with wire
loop, malleable
190 mm



05-199
2,5 mm
05-200
2,5 mm
05-201
3,0 mm

1/2

05-159 145 mm
05-160 160 mm
05-161 200 mm
Probes with eye



1,5 mm

1/2

05-162
Myrtle leaf probe
145 mm



2,0 mm

1/2

05-163 130 mm
05-164 145 mm
05-165 160 mm
05-166 180 mm
05-167 200 mm



1/4

05-168
Probes



1/2

05-169
Double ended probe,
malleable, diam. of tips
3 mm with hole
190 mm



05-170

Double ended probes,
tin, malleable,
diam. of tips
3,5 mm with hole
250 mm, 300 mm



1/4

05-171
Double ended probes,
tin, malleable,
diam. of tips 4 mm
400 mm



1/2

05-172 1,5 mm
05-173 2,0 mm
05-174 2,5 mm
300 mm

∅ tip

**Suturing Instrument Set, Pocket Instrument Set
Wundnahtbesteck, Chirurgisches Taschenbesteck**



05-175

Suturing instruments set, in metal case consisting of: Scissors, curved, sharp/sharp, 115mm
25 MICHEL clip, 16 x 3mm
1 Delicate tissue forceps, 130mm
1 Scalpel, bellied
1 MATHIEU needle holder, 140mm
1 Perforated metal case, stainless containing:
1 Suture needle
1 item 1 item



05-176

Pocket instrument set, in metal case consisting of:

Bottom tray

1 MATHIEU needle holder, 140mm
1 MICHEL clip forceps, combined
1 Myrtle leaf probe, 130mm
1 Sharp double curette
1 Skin hook
1 Detachable scalpel handle, no.4
1 Perforated metal case, containing
6 Scalpel blades
1 Perforated metal case, stainless, containing
1 Suture needle
1 item
1 item

Top tray

1 Tissue forceps, 130mm
1 KOCHER haemostatic forceps, 130mm
1 Straight surgical scissors, 130mm
1 Dissecting forceps, 130mm
1 FEILCHENFELD splinter forceps, 115mm
25 MICHEL clip, 16 x 3mm
1 Flacon of suture skin, sterile in alcohol



05-177

Pocket instrument set, in metal case consisting of:

Bottom tray

1 MAYO-HEGER needle holder, 150mm
1 MICHEL clip forceps, combined
1 Myrtle leaf probe, 130mm
1 Sharp double curette
1 Skin hook
1 Detachable scalpel handle, no. 4
1 Perforated metal case, consisting
6 Scalpel blades
1 Perforated metal case, stainless, consisting:
1 Suture needle
1 item, & 1 item

Top tray

1 Tissue forceps, 130mm
1 CRILE haemostatic forceps, 140mm
1 Straight surgical scissors, 130mm
1 Dissecting forceps, 130mm
1 FEILCHENFELD splinter forceps, 115mm
25 MICHEL clip, 16 x 3mm
1 Flacon of suture silk, sterile in alcohol



Fine Wound Retractors (Dura- and Skin Retractors)
Feine Wundhakchen (Dura- und Hauthakchen)

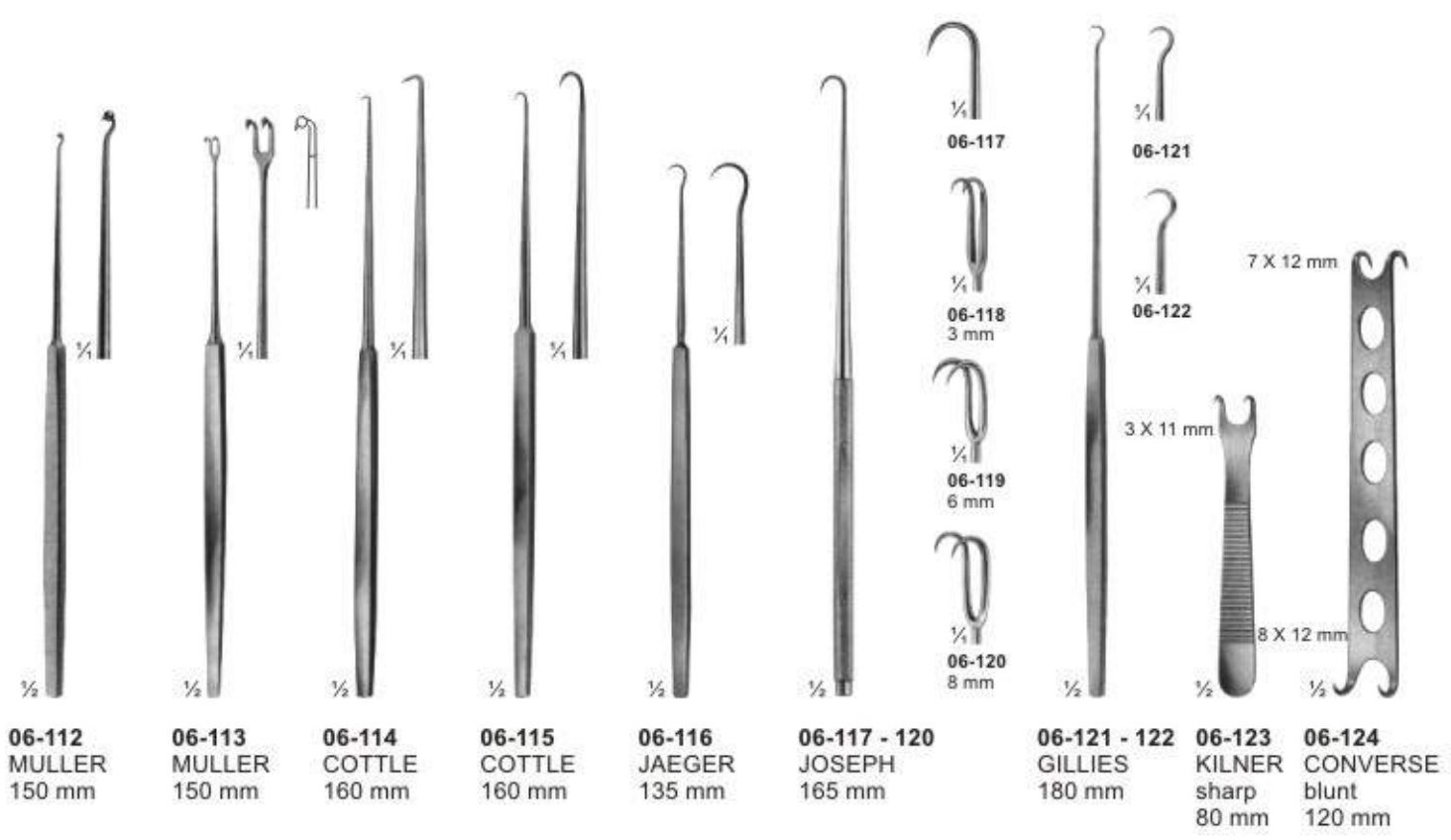
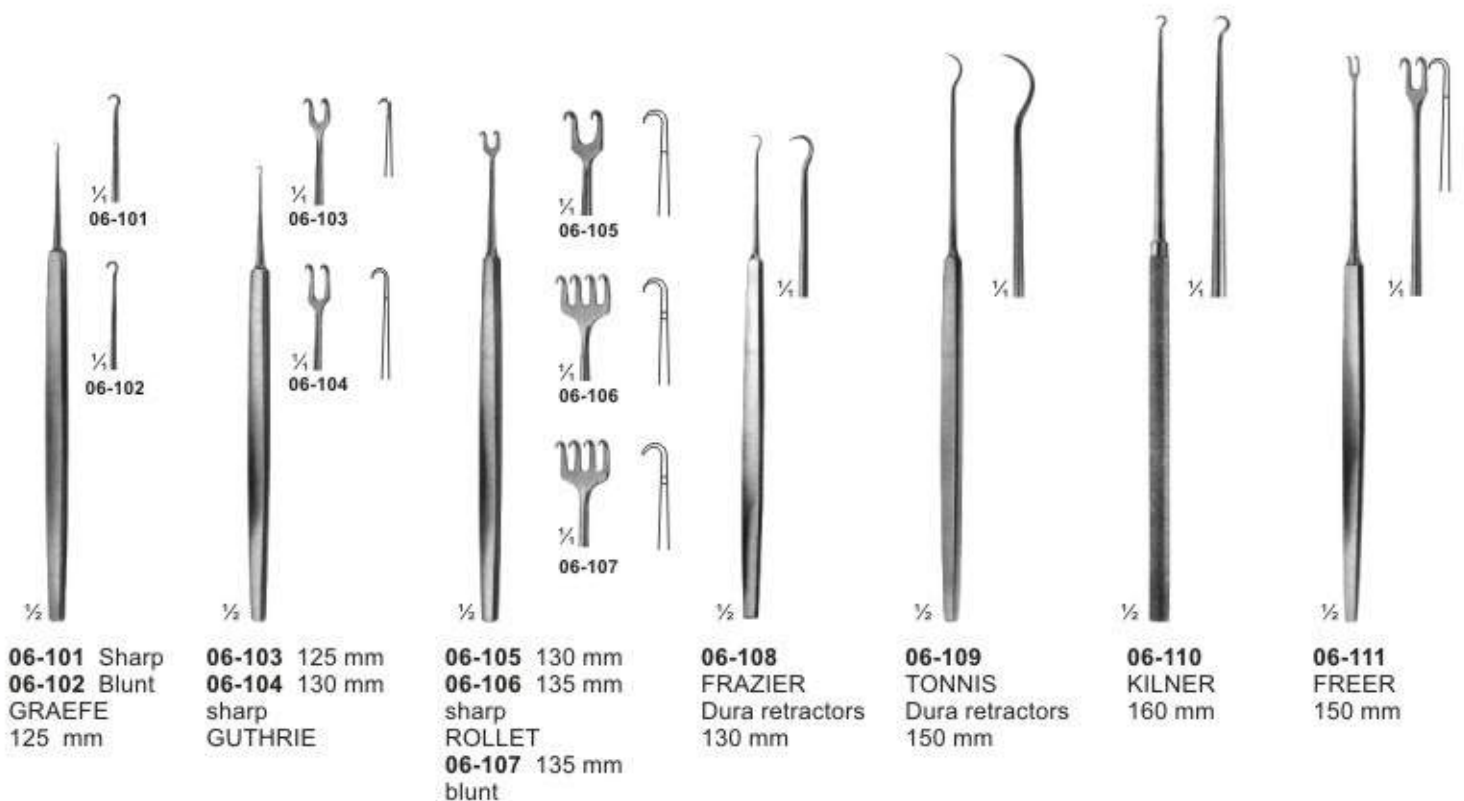

**Retractors With treangle handle
Wundhaken mit Treangle-Griff**



<p>1/2</p>	<p>1/4</p>	<p>1/4</p>	<p>1/4</p>	<p>1/4</p>
<p>06-125 MANNERFELT modif. sharp 135 mm</p>	<p>06-126 MANNERFELT modif. sharp 155 mm</p>	<p>06-127 MANNERFELT modif. sharp 155 mm</p>	<p>06-128 - 130 MANNERFELT modif. small curve, sharp 155 mm</p>	<p>06-131 - 133 MANNERFELT modif. large curve, blunt 155 mm</p>
<p>1/2</p>	<p>06-134 15 x 6 mm</p> <p>06-135 20 x 6 mm</p> <p>06-136 25 x 6 mm</p> <p>06-137 30 x 8 mm</p>	<p>06-138 12 x 12 mm</p> <p>06-139 12 x 14 mm</p> <p>06-140 14 x 16 mm</p>		<p>1/4</p>
<p>06-134 - 137 LANGENBECK- MANNERFELT modif. 155 mm</p>		<p>06-138 - 140 MANNERFELT modif. Saddle hooks, 155 mm</p>		<p>06-141 MANNERFELT modif. Saddle hooks, fenestrated 155 mm</p>

Retractors Wundhaken

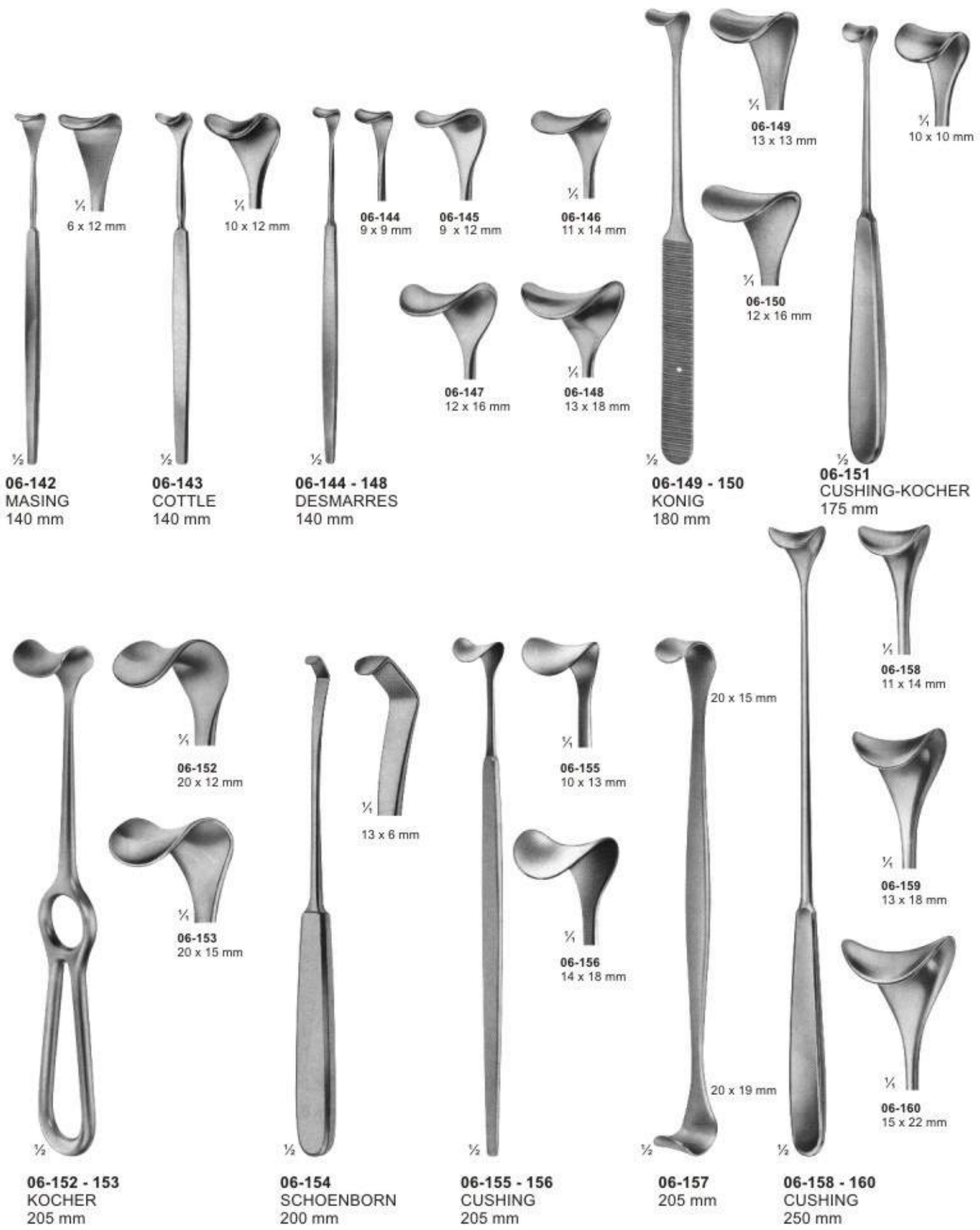



Bone Retractors and Retractors Knochen- und Wundhaken



06-169
KOCHER
sharp
205 mm



06-170
KOCHER
sharp
220 mm



06-171
KOCHER
sharp
220 mm



06-172
VOLKMANN
blunt
220 mm



06-173
VOLKMANN
sharp
220 mm



06-174 - 181
VOLKMANN
225 mm

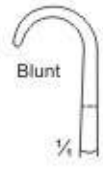
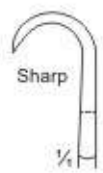

06-174
9 x 8 mm



06-175
9 x 13 mm



06-176
9 x 19 mm



06-177
9 x 29 mm



06-178
8,5 x 8 mm



06-179
8,5 x 13 mm



06-180
8,5 x 19 mm



06-181
8,5 x 29 mm

**Retractors
Wundhaken**



**06-182 - 184
MIDDENDORPF**



06-182
15 x 15 mm
220 mm



06-183
20 x 22 mm
215 mm



06-184
28 x 28 mm
235 mm



1/4



1/4



1/4



**06-185
BUCHS**
205 mm



38 x 18 mm



67 x 17 mm

1/4



**06-186
CASPAR**
210 mm



**06-187
KOCHER**
230 mm

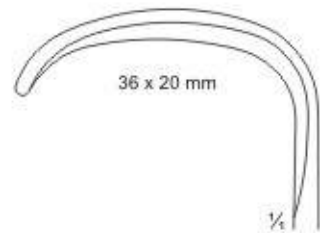

36 x 20 mm

1/4

Retractors, Vario Retractor System
Wundhaken, Vario- Wundhaken-System



06-212 80 x 20 mm



06-188 - 194
BRUNNER
275 mm

- 06-188 80 x 20
- 06-189 100 x 25
- 06-190 120 x 25
- 06-191 130 x 30
- 06-192 140 x 30
- 06-193 160 x 30
- 06-194 180 x 30



06-195
Handle with cold
light carrier for
retractor blades.
280 mm



Handle arrange-
ment verriable

Retractors, Lung Spatulas
Wundhaken, Lungenspatel



Retractors for deep surgery (Abdominal Retractors)
Wundhaken für Eingriffe in der Tiefe (Bauchdeckenhaken)

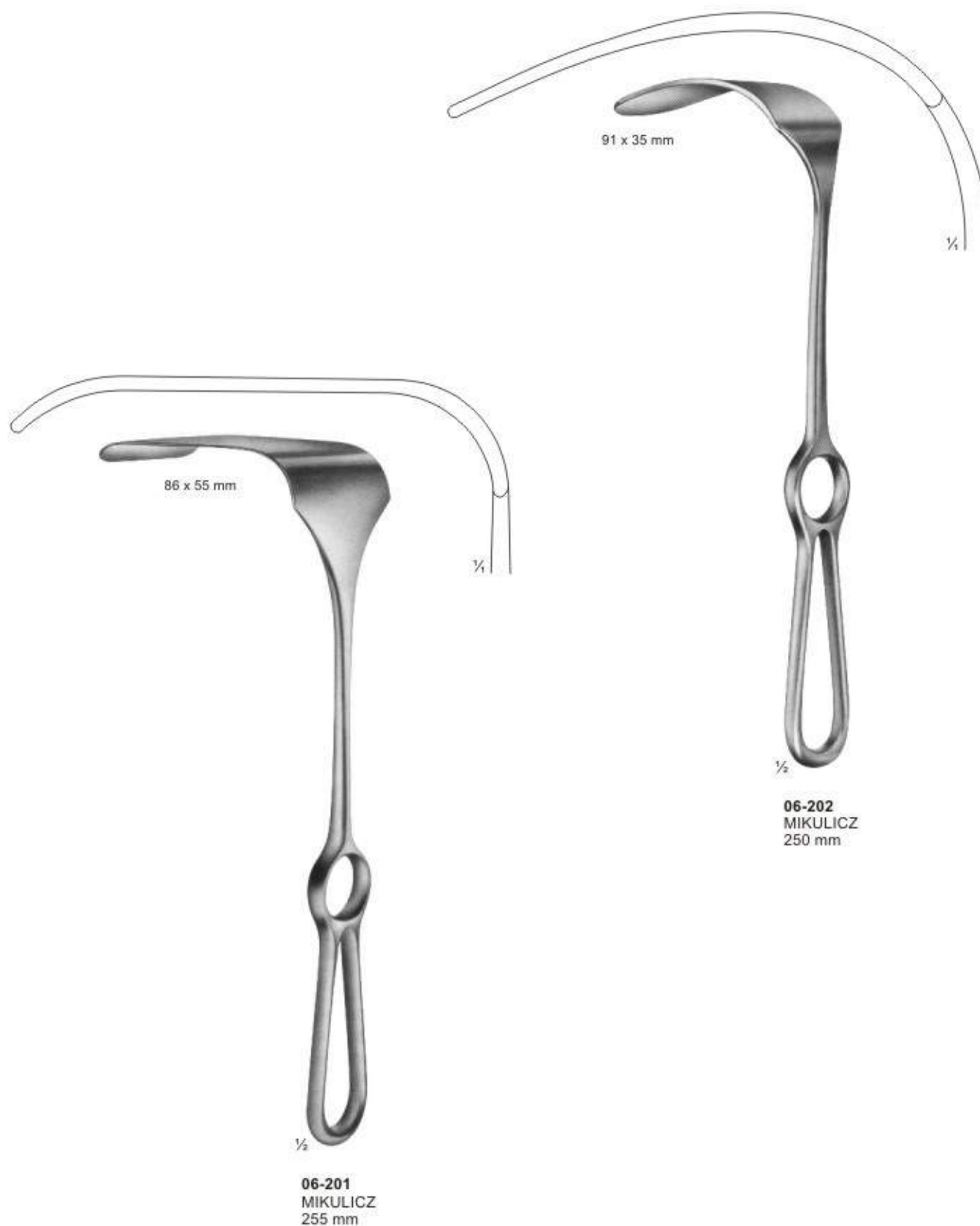

Retractors, Abdominal Retractors
Wundhaken, Bauchdeckenhaken



- 06-214 Fig.1 32 x 40 mm
- 06-215 Fig.2 34 x 50 mm
- 06-216 Fig.3 41 x 60 mm
- 06-217 Fig.4 46 x 75 mm
- 06-218 Fig.5 64 x 85 mm

06-203 - 213
DOYEN
 240 mm

06-214 - 218
FRITSCH
 240 mm

06-219
DOYEN
 250 mm

	width of blades	35 mm, 45 mm, 60 mm
length of blades	06-203, 06-204, 06-205	62 mm
	06-206, 06-207, 06-208	92 mm
	06-209, 06-210, 06-211	122 mm
	06-212, 06-213	160 mm

Abdominal- and Intestinal Spatulas
Bauch- und Darmspatel

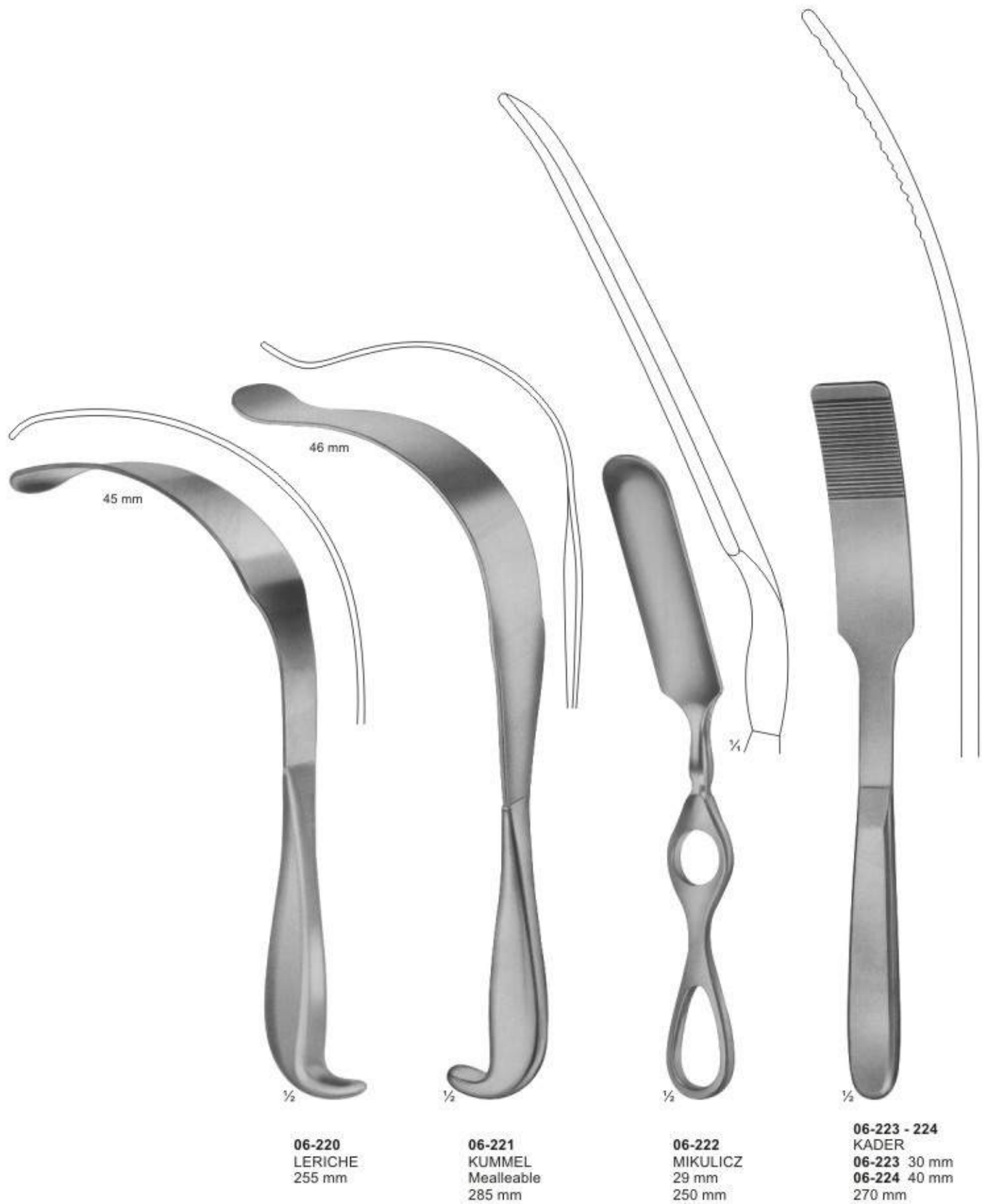

Self-Retaining Retractors Wundspreizer

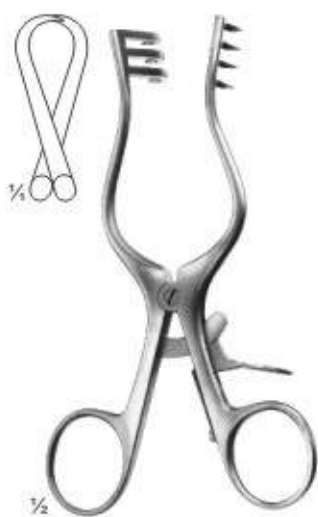

06-225
WEITLANER
sharp
130 mm

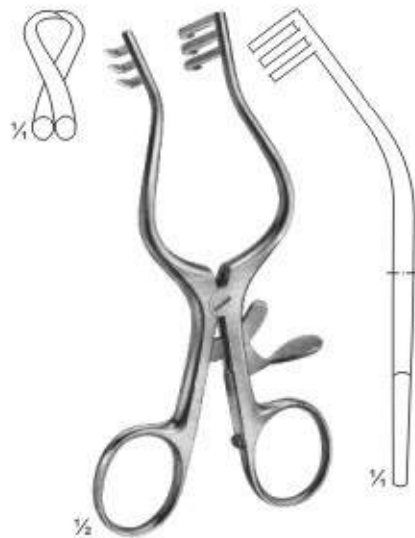

06-226
WULLSTEIN
sharp
130 mm

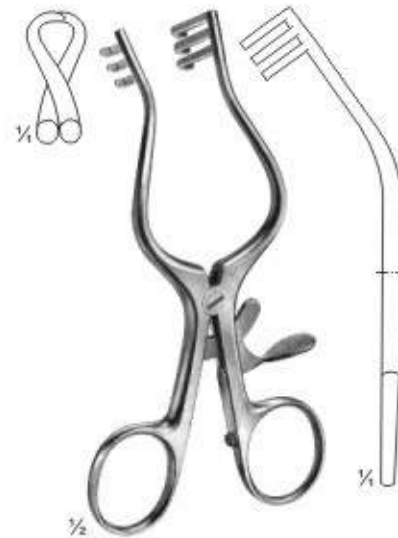

06-227
WULLSTEIN
blunt
130 mm

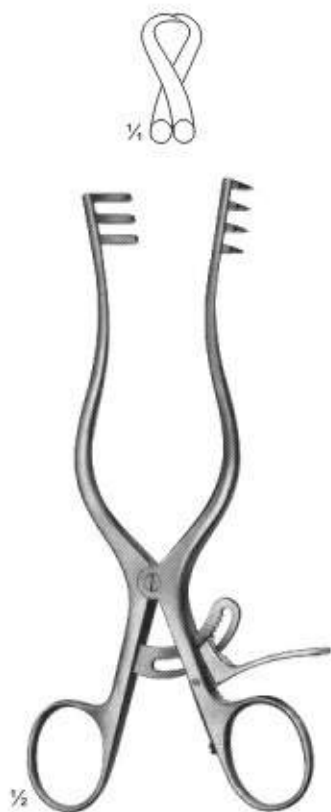

06-228
WEITLANER
sharp
165 mm



06-229
PLESTER
blunt
110 mm



06-230
PERKINS
blunt
130 mm



06-231
 JOLL (FRIEDMAN)
 Thyroid- and vaginal retractor
 155 mm



06-232
 JACKSON BURROWS
 Retractor, blunt
 185 mm



06-233
 GELPI
 Vaginal retractor
 135 mm



06-234
 GELPI
 Skin- and vaginal retractor
 175 mm



06-235
 DE BAKEY
 Femur retractor
 145 mm

Lamina Spreaders Wirbelkorperspreizer



06-236
CLOWARD
155 mm



06-237
CLOWARD
135 mm



06-238
INGE
170 mm

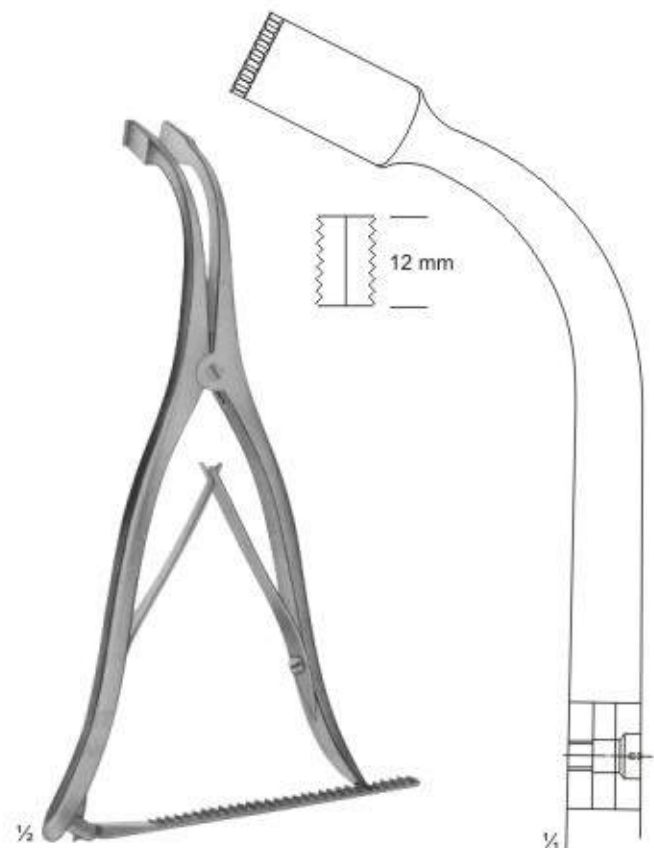

06-239
INGE
275 mm

Abdominal Retractors Bauchdeckenhalter



06-240
GOSSET
Blades:38 mm deep

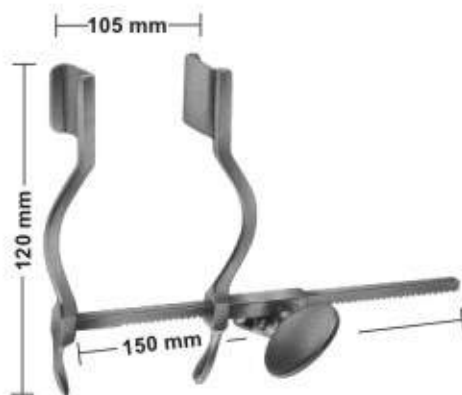

06-241
HERTZLER
Blades 20 X 25 mm

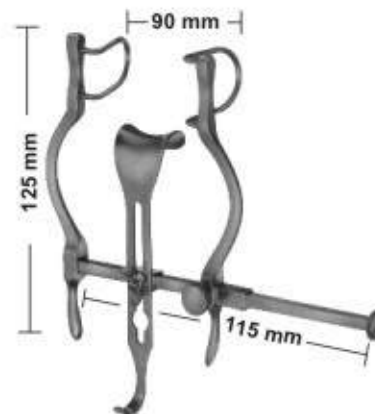

06-242
BALFOUR-BABY
Lateral blades 27 mm deep
Center blade 21x24 mm

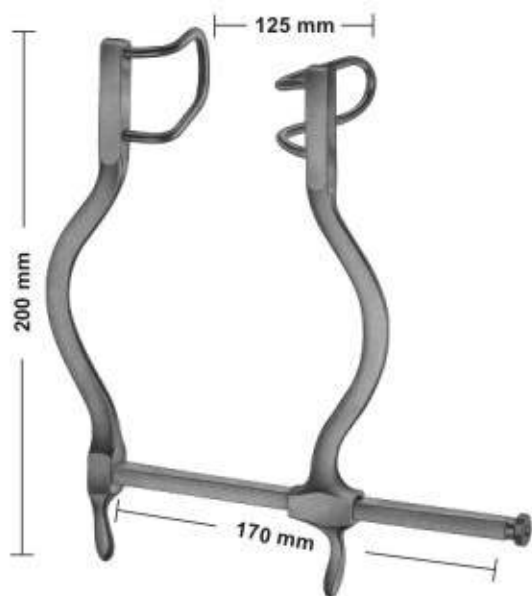

06-243
GOSSET
Blades:55mm deep

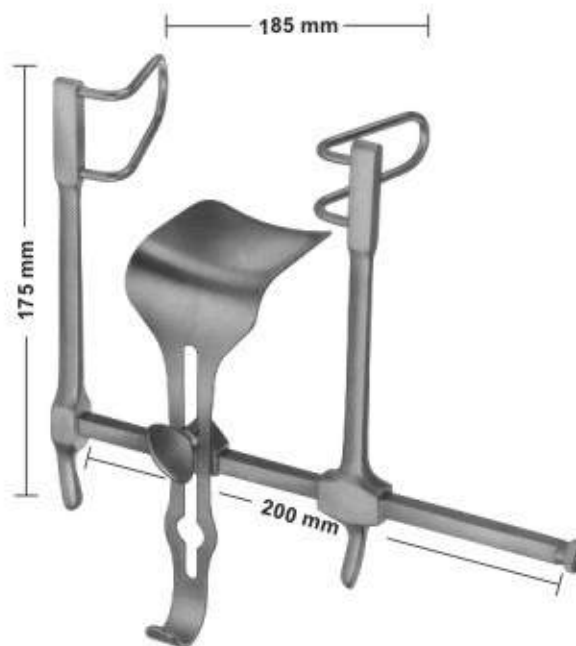

06-244
GOSSET
Lateral blades 58 mm deep
Center blade 59 x 57 mm

Abdominal Retractors Bauchdeckenhalter

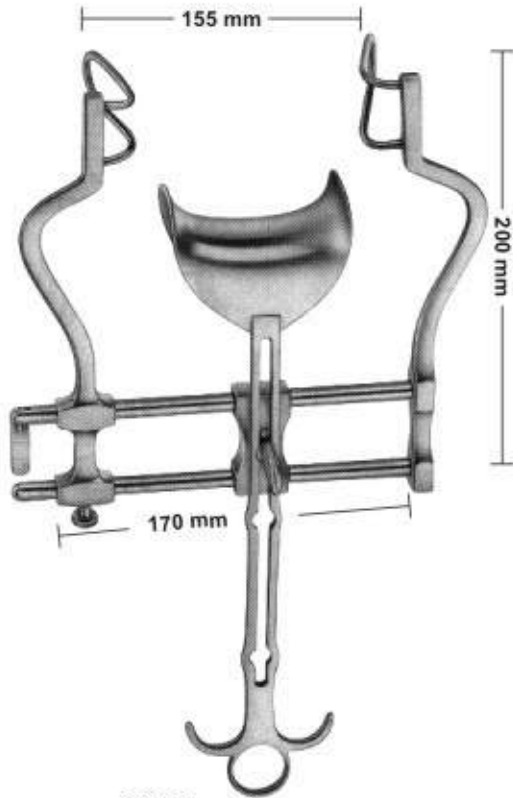

06-245
BALFOUR
Lateral blades 60 mm deep
Center blade 47 x 80 mm

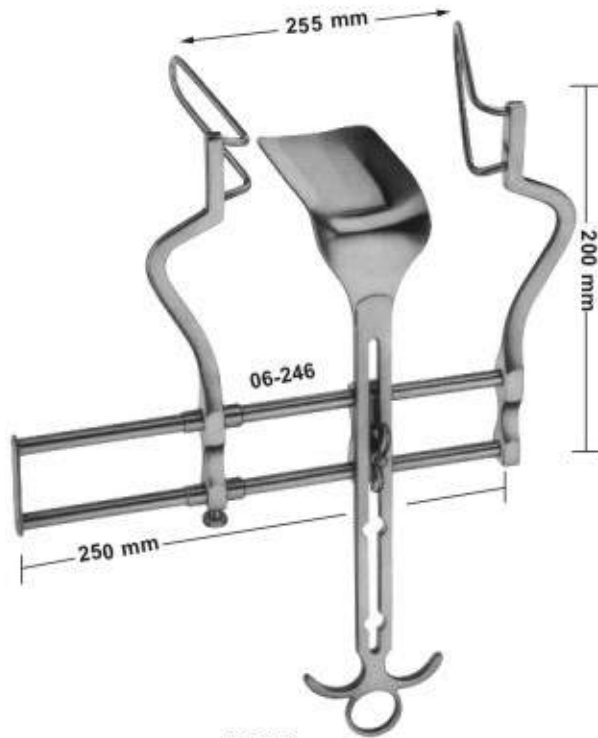

06-246
BALFOUR
Lateral blades 105 mm deep
Center blade 107x 59 mm



06-247
Center blade only
54x80 mm

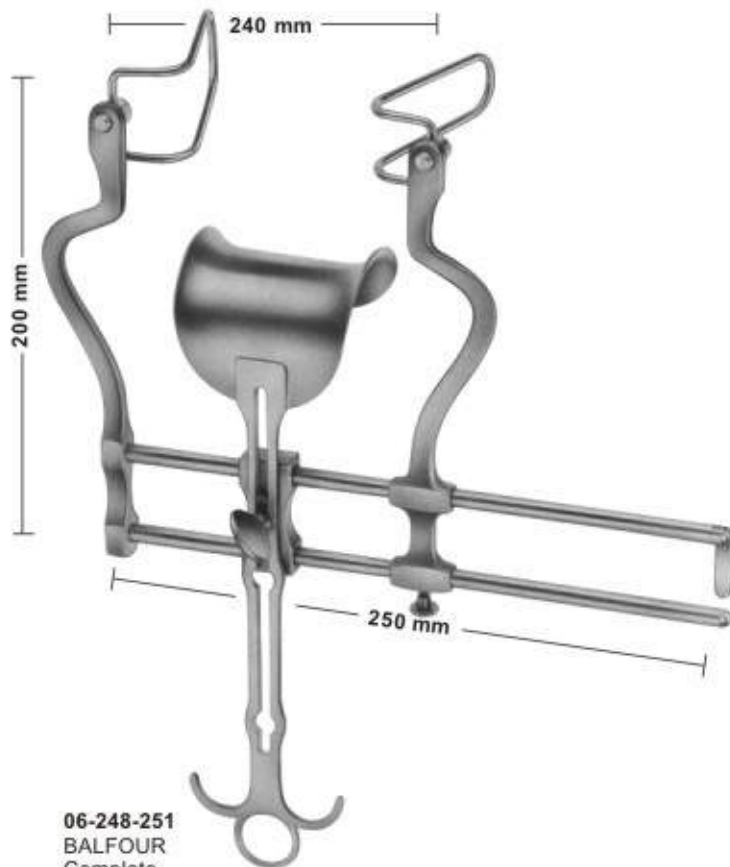

06-248-251
BALFOUR
Complete
Spreader only **06-248** **06-249** **06-250** **06-251**
Lateral blades 50 mm 60 mm 75 mm 90 mm
Center blade 47 x 80 mm 62x76 mm 80x80 mm 80x80 mm



Lateral blades
06-252 50 mm deep
06-253 60 mm deep
06-254 75 mm deep
06-255 90 mm deep
Sales Unit of blades: PR = pair

Organ-, Tissue and Intestinal Grasping Forceps
 Organ-, Gewebe- und Darmfaßzangen

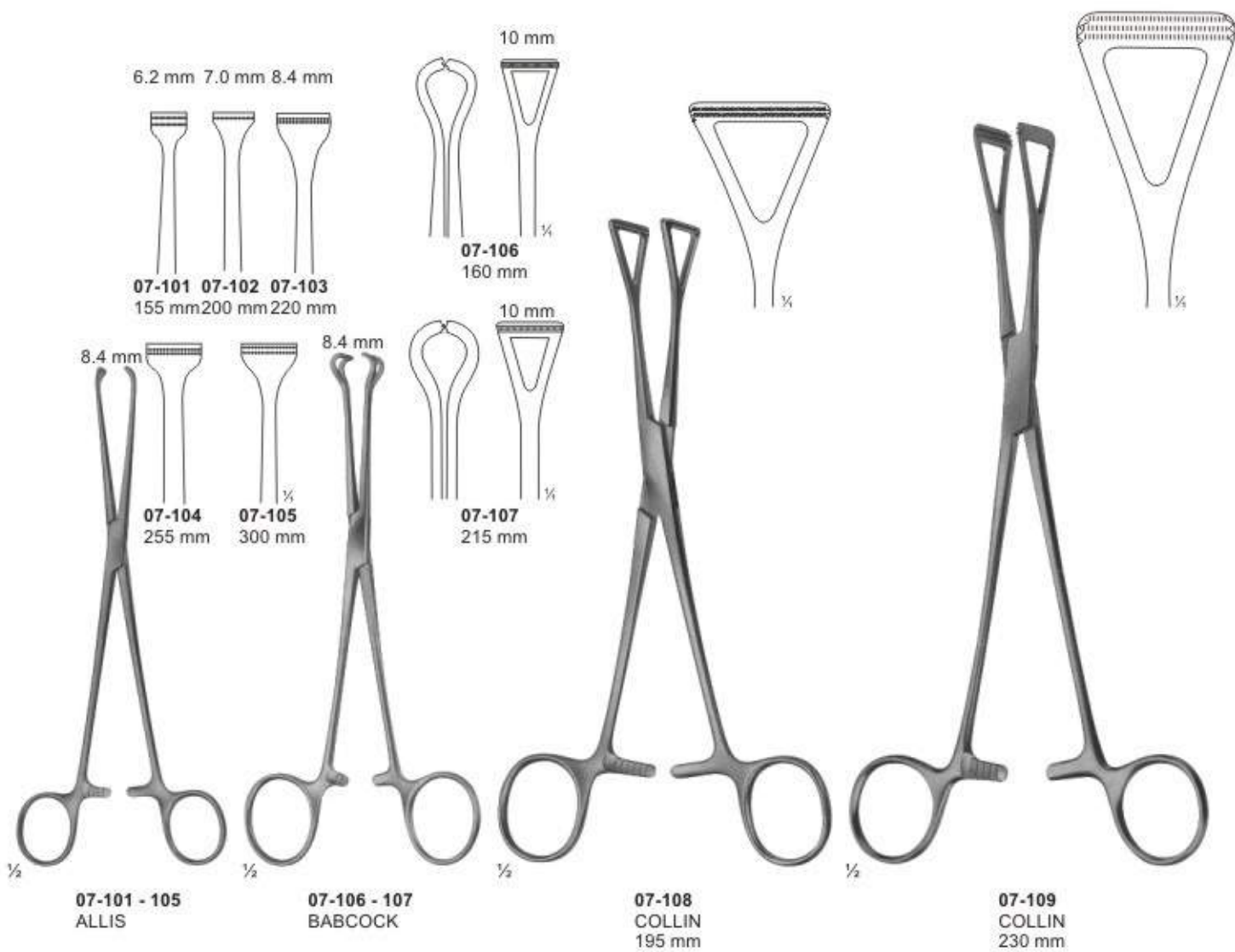

**Intestinal Clamps, soft elastic
Darmklemmen, weich federnd**



ATRAUMATA



ATRAUMATA

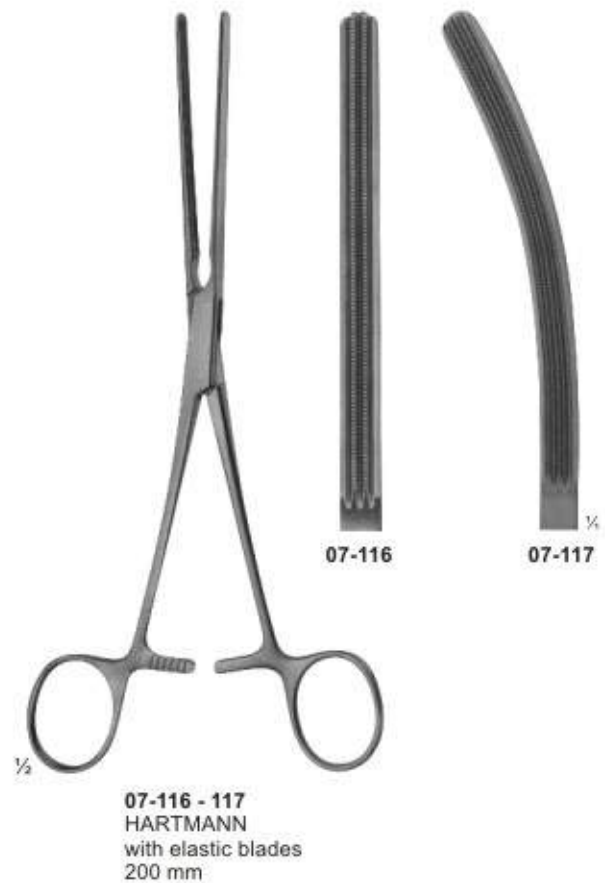
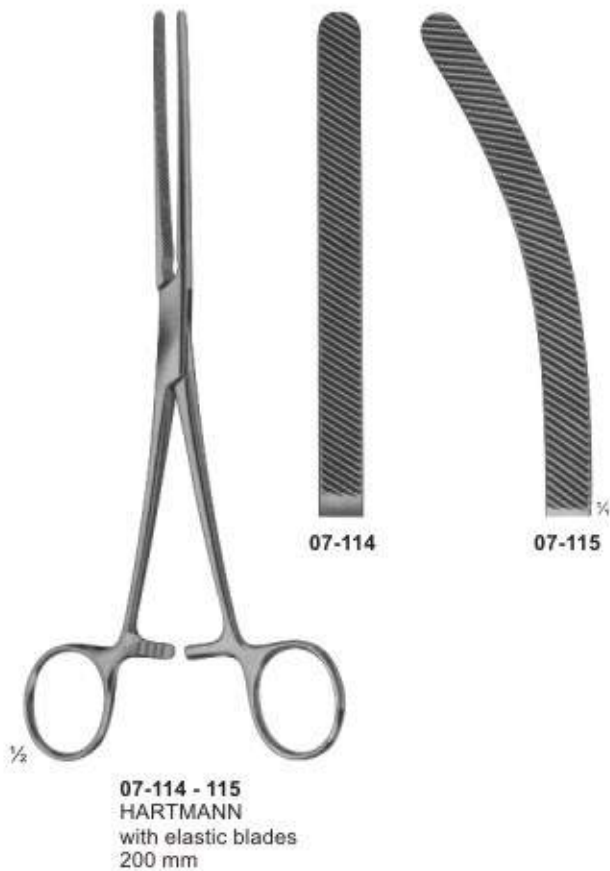

Intestinal and Pylorus Clamps Dram- und Magenquetschklemmen



07-118
PAYR
Intestinal clamp
light pattern,
for children
180 mm

07-119
PAYR
200 mm

07-120
PAYR
275 mm

07-121
PAYR
Pylorus clamp
315 mm

ATRAUMATA
Sigmoid Anastomosis Forceps
Rektum-Anastomosenklemmen

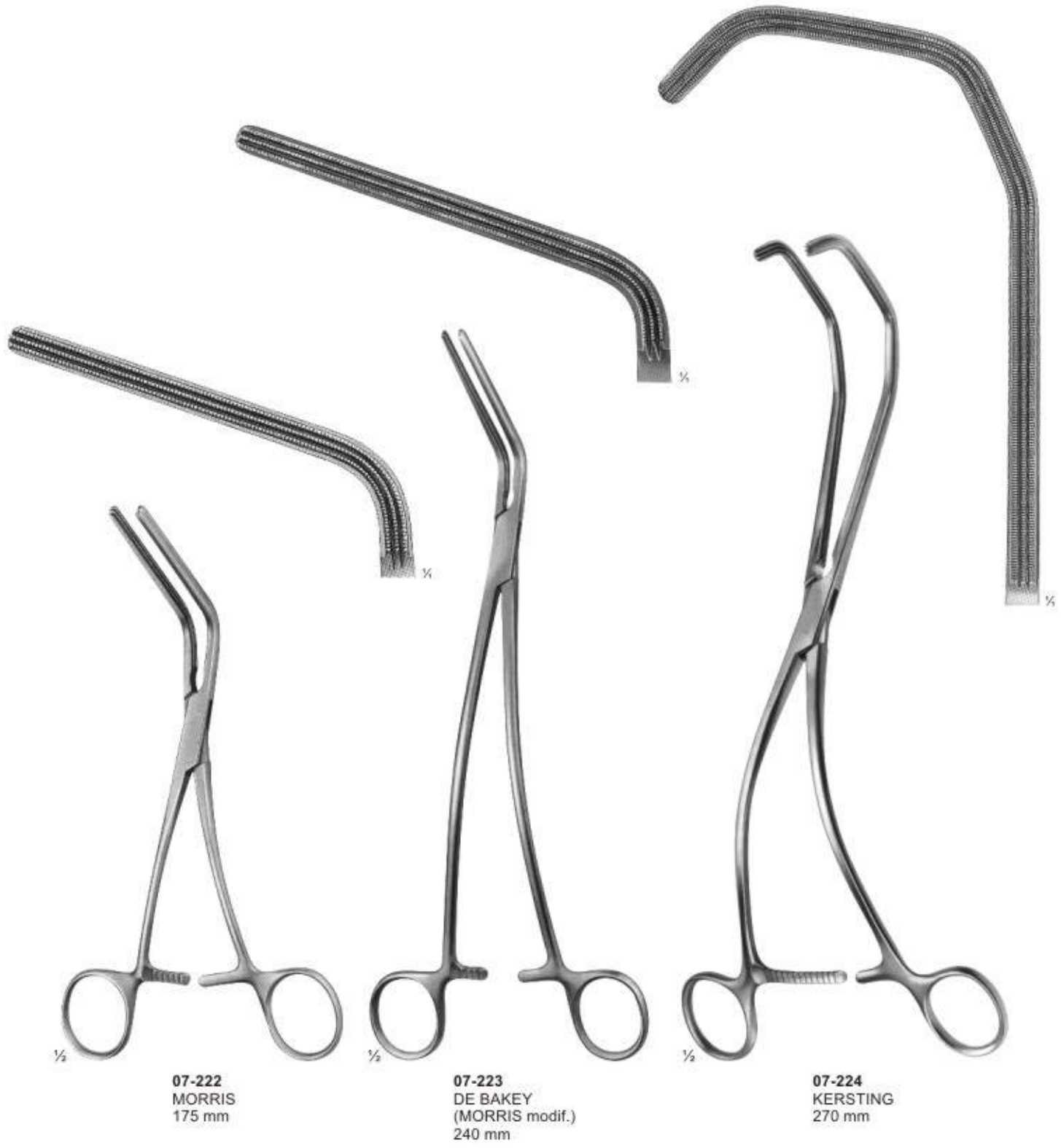

1/4
07-222
MORRIS
175 mm

1/4
07-223
DE BAKEY
(MORRIS modif.)
240 mm

1/4
07-224
KERSTING
270 mm

Rectal Specula Mastdarm-Rektum-Spekula

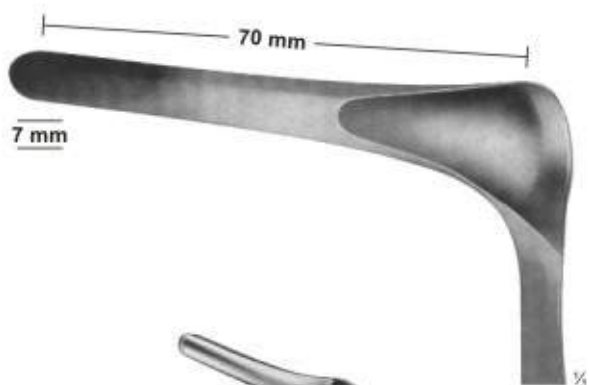

08-101
KILLIAN
for children
145 mm



08-102
SIMS
160 mm



08-103
SIMS
160 mm

Anusopes-Sphincteroscopes
Anuskope-Sphinkteroskope

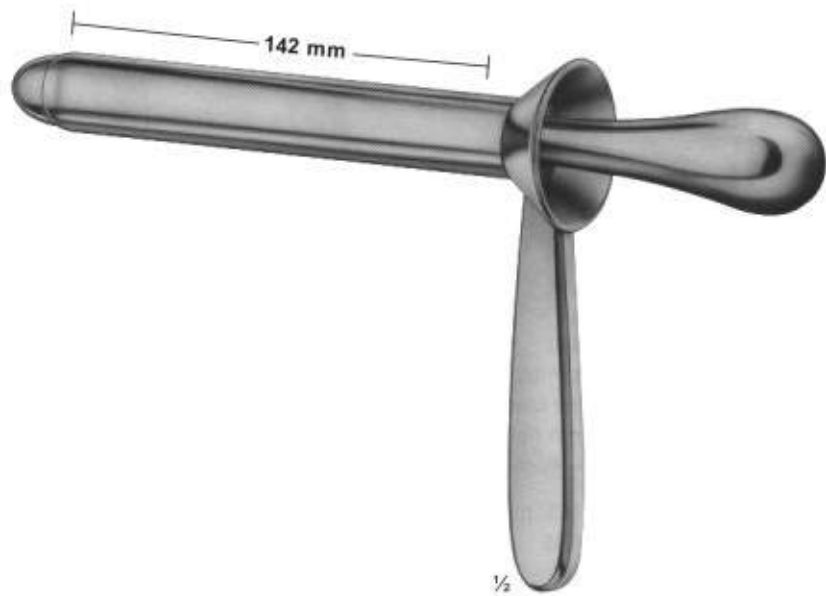

Biopsy forceps for rectum
Biopsiezangen für Rektum

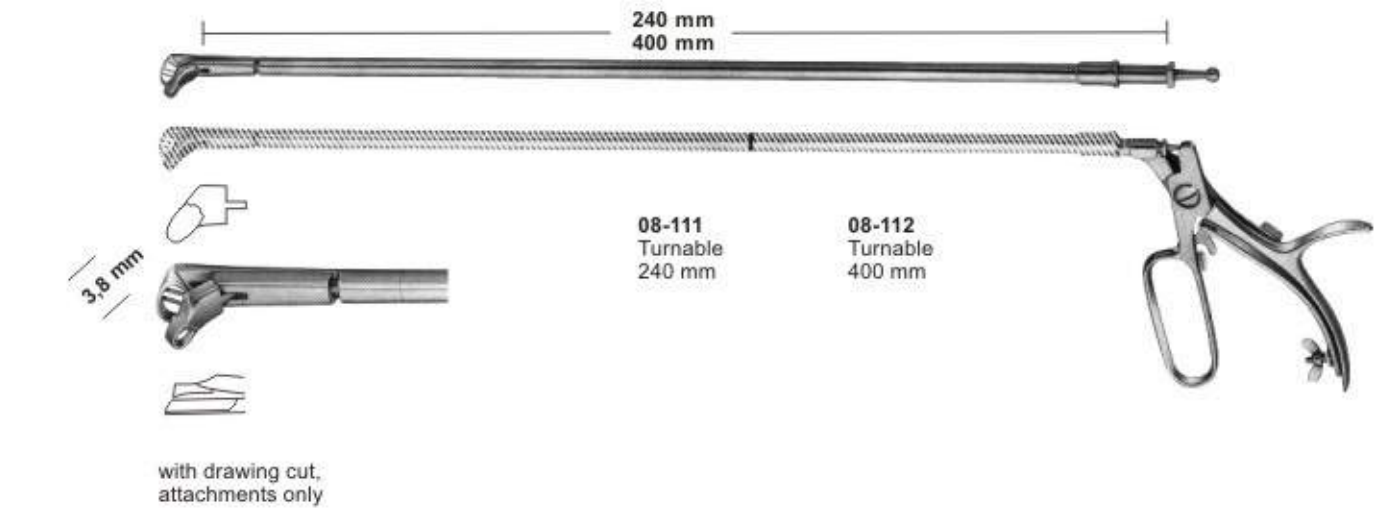
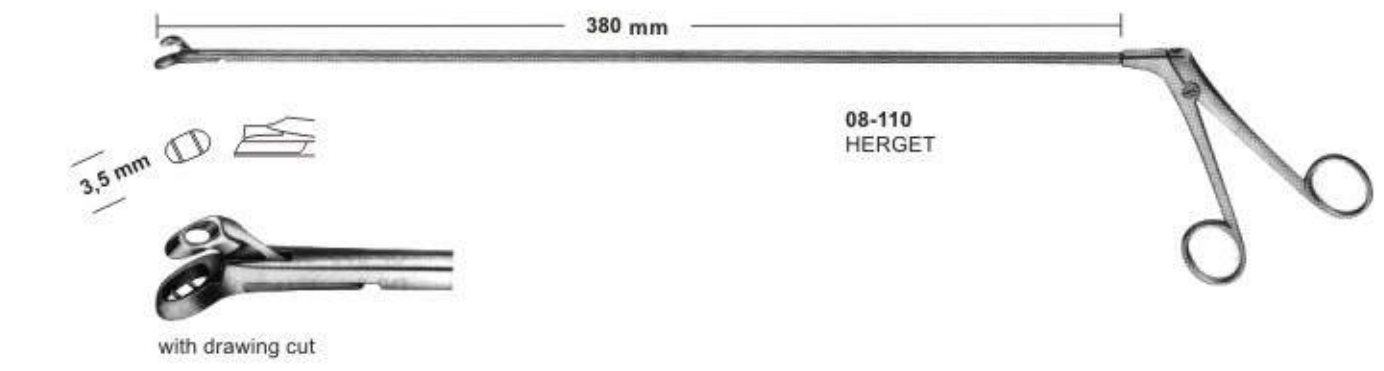
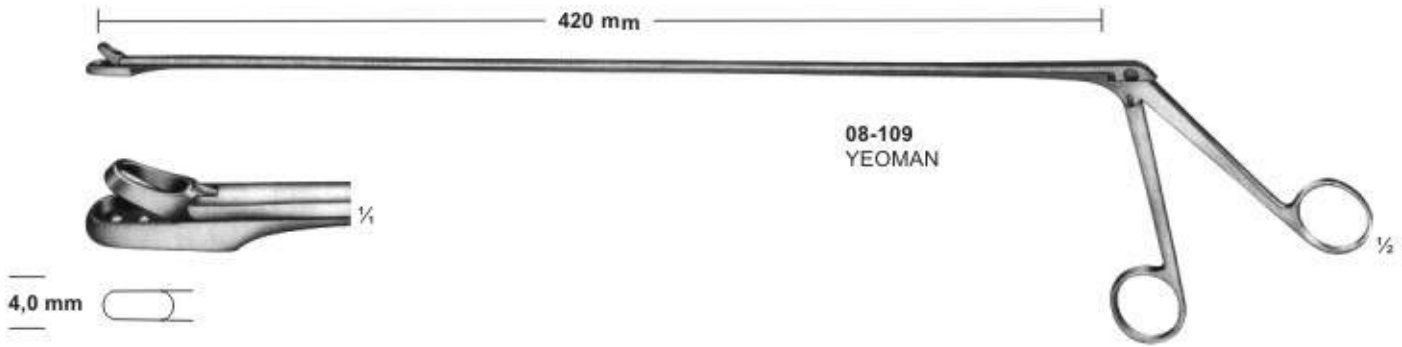
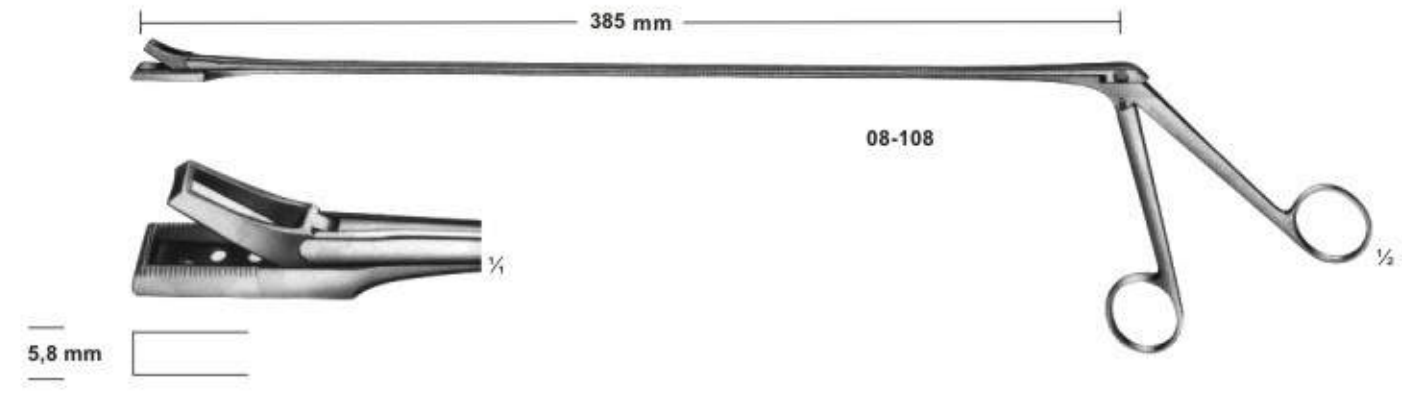

ATRAUMATA

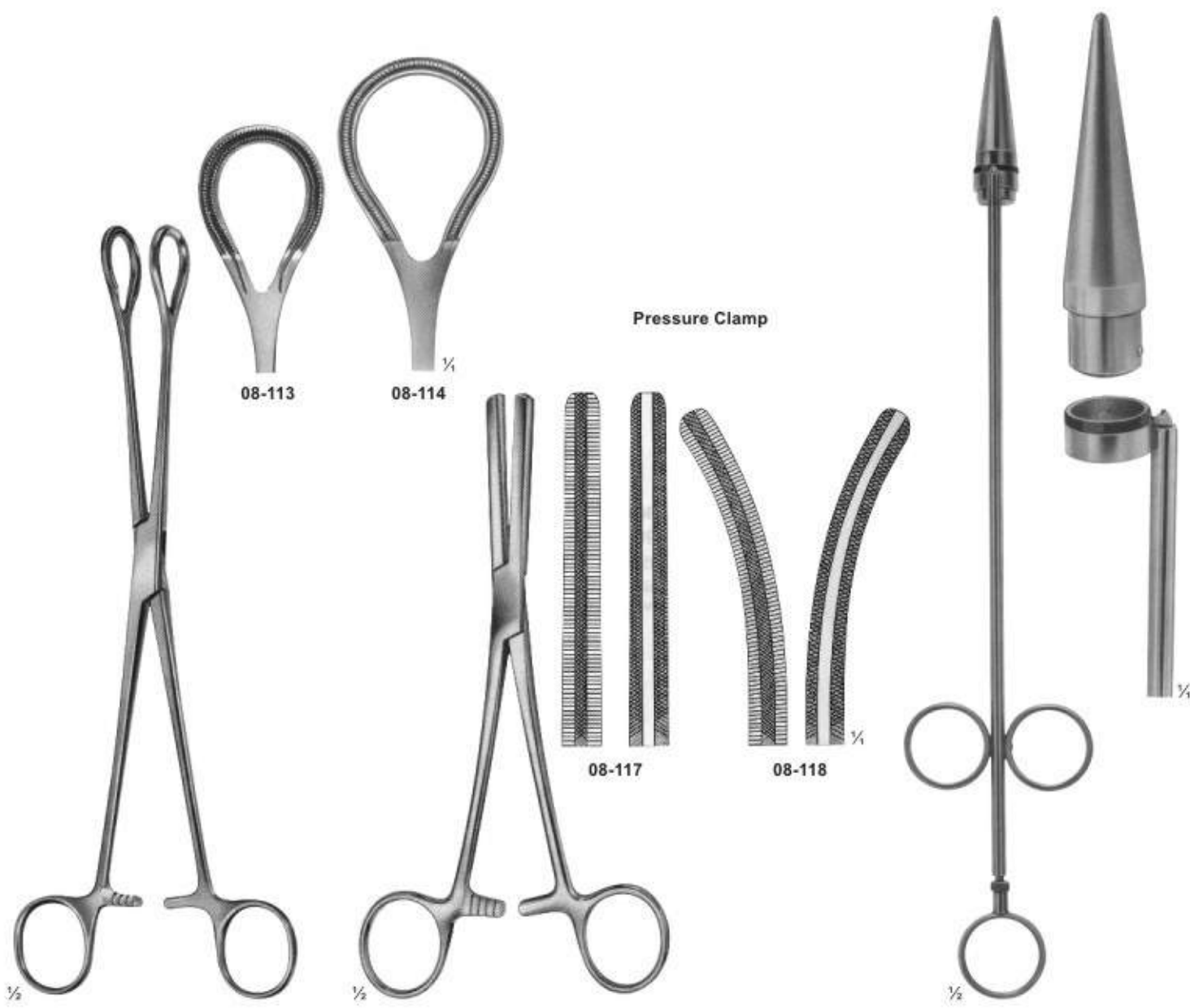

08-113 - 114
250 mm
08-114
270 mm

08-115 - 116
FERGUSSON
200 mm

08-119
RUDD
Haemorrhoidal ligator
with loading
attachment and 100
ligature rubber rings
315 mm

Gall Duct Forceps Gallenkanal-Klemmzangen



08-120
LOWER
180 mm



08-121
LAHEY (SWEET)
190 mm



08-123
LAHEY
220 mm



08-124
DESJARDINS
Gall duct-and cystic forceps
210 mm



08-125
NISSEN
Gall duct-and cystic forceps
215 mm

Gall Duct Dilators and Gall Stone Scoops

Gallengangdilatoren und Gallensteinloffel

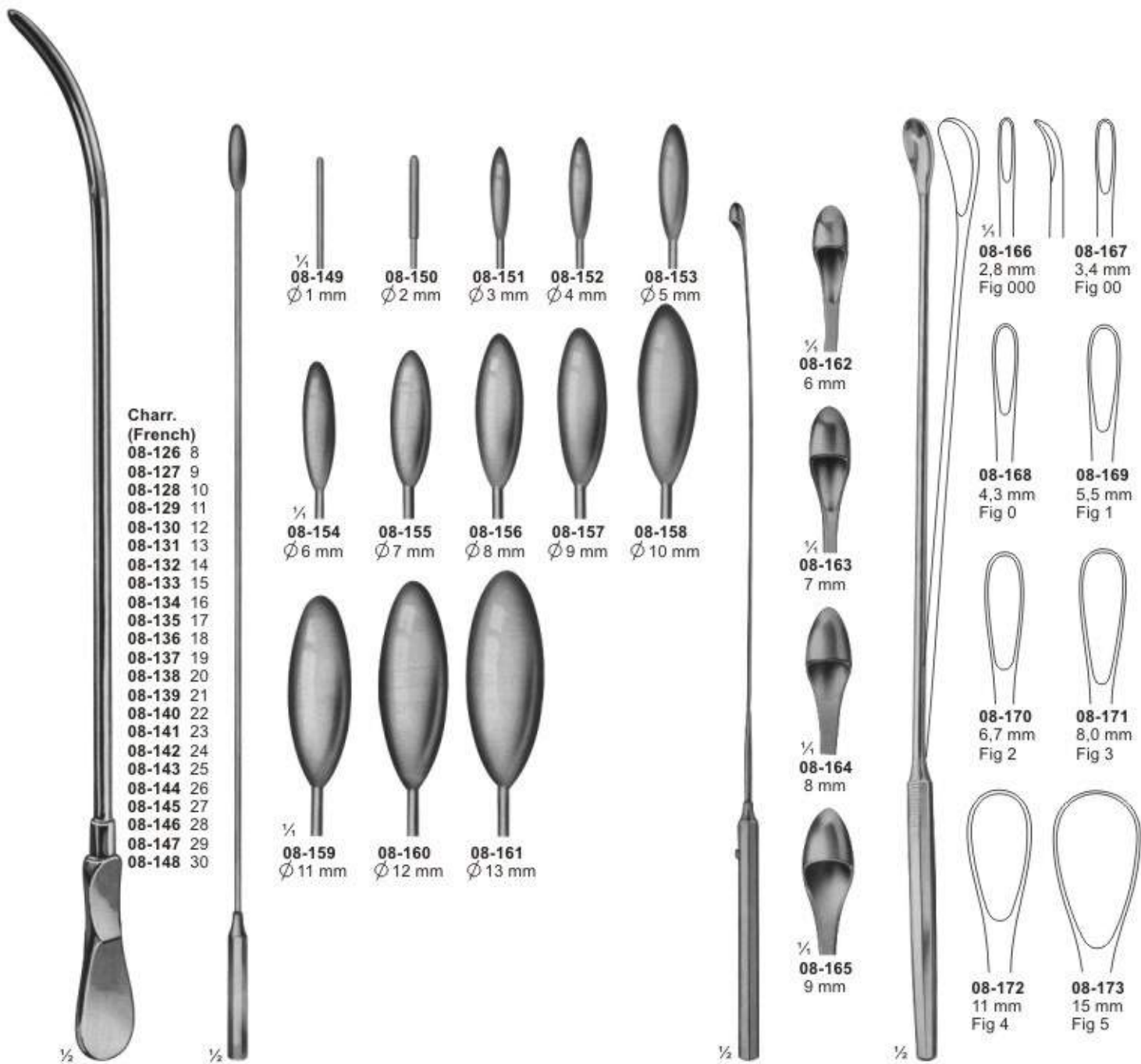

Charr.
(French)
08-126 8
08-127 9
08-128 10
08-129 11
08-130 12
08-131 13
08-132 14
08-133 15
08-134 16
08-135 17
08-136 18
08-137 19
08-138 20
08-139 21
08-140 22
08-141 23
08-142 24
08-143 25
08-144 26
08-145 27
08-146 28
08-147 29
08-148 30

1/2 08-149 Ø 1 mm
08-150 Ø 2 mm
08-151 Ø 3 mm
08-152 Ø 4 mm
08-153 Ø 5 mm
1/2 08-154 Ø 6 mm
08-155 Ø 7 mm
08-156 Ø 8 mm
08-157 Ø 9 mm
08-158 Ø 10 mm
1/2 08-159 Ø 11 mm
08-160 Ø 12 mm
08-161 Ø 13 mm

1/2 08-162 6 mm
1/2 08-163 7 mm
1/2 08-164 8 mm
1/2 08-165 9 mm
1/2 08-166 2,8 mm Fig 000
08-167 3,4 mm Fig 00
08-168 4,3 mm Fig 0
08-169 5,5 mm Fig 1
08-170 6,7 mm Fig 2
08-171 8,0 mm Fig 3
08-172 11 mm Fig 4
08-173 15 mm Fig 5

08-126 - 148
DITTEL
Metall bougies and
dilating sounds, stiff
345 mm

08-149 - 161
BAKES
Common bile duct
dilators, malleable
08-149-153 315 mm
08-154-161 320 mm

08-162 - 165
DESJARDINS
Probe and catch
with flexible schaft
300 mm

08-166 - 173
LUER-KOERTE modif
with malleable shaft
310 mm

**Gall Stone Forceps
Gallensteinzangen**

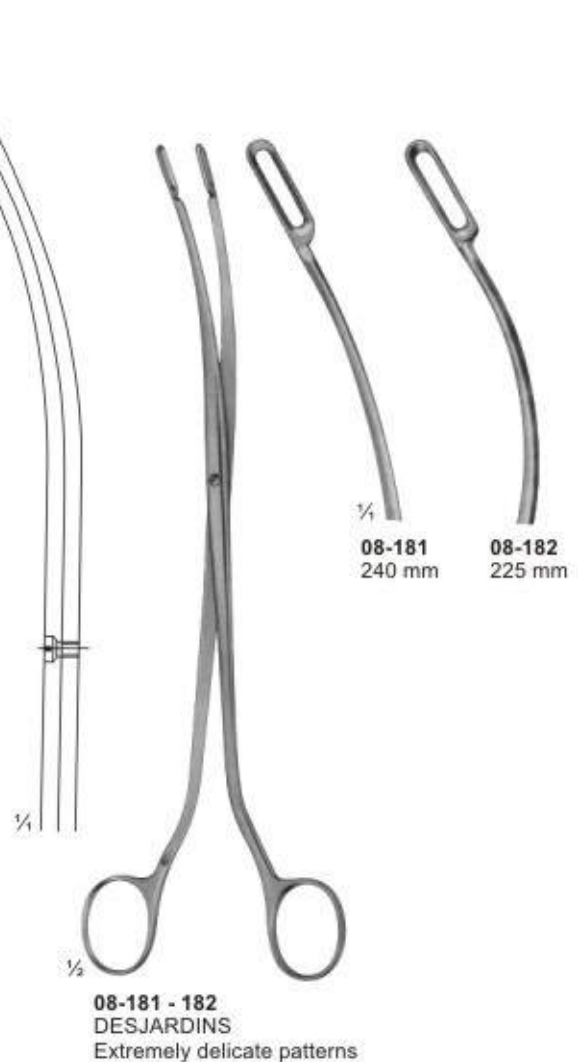
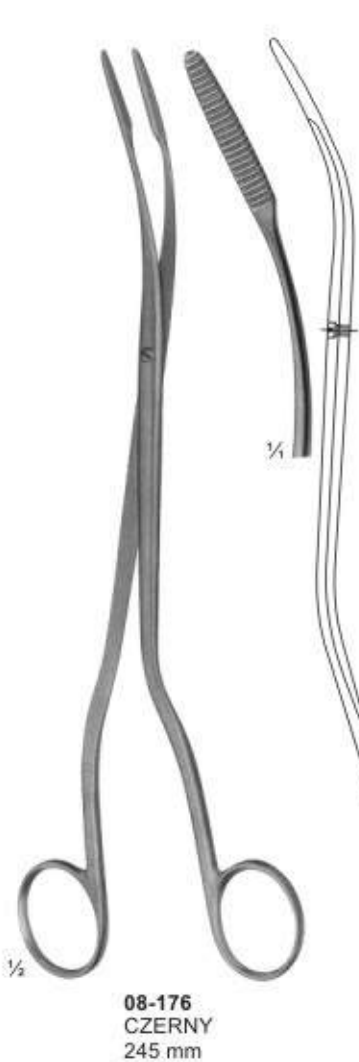
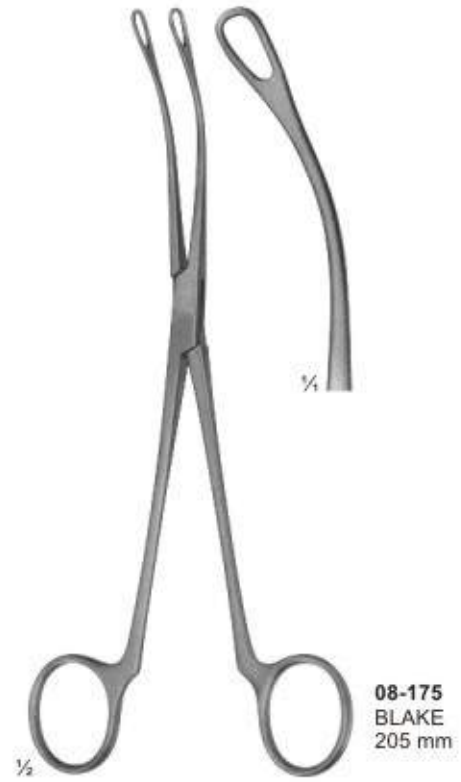

ATRAUMATA

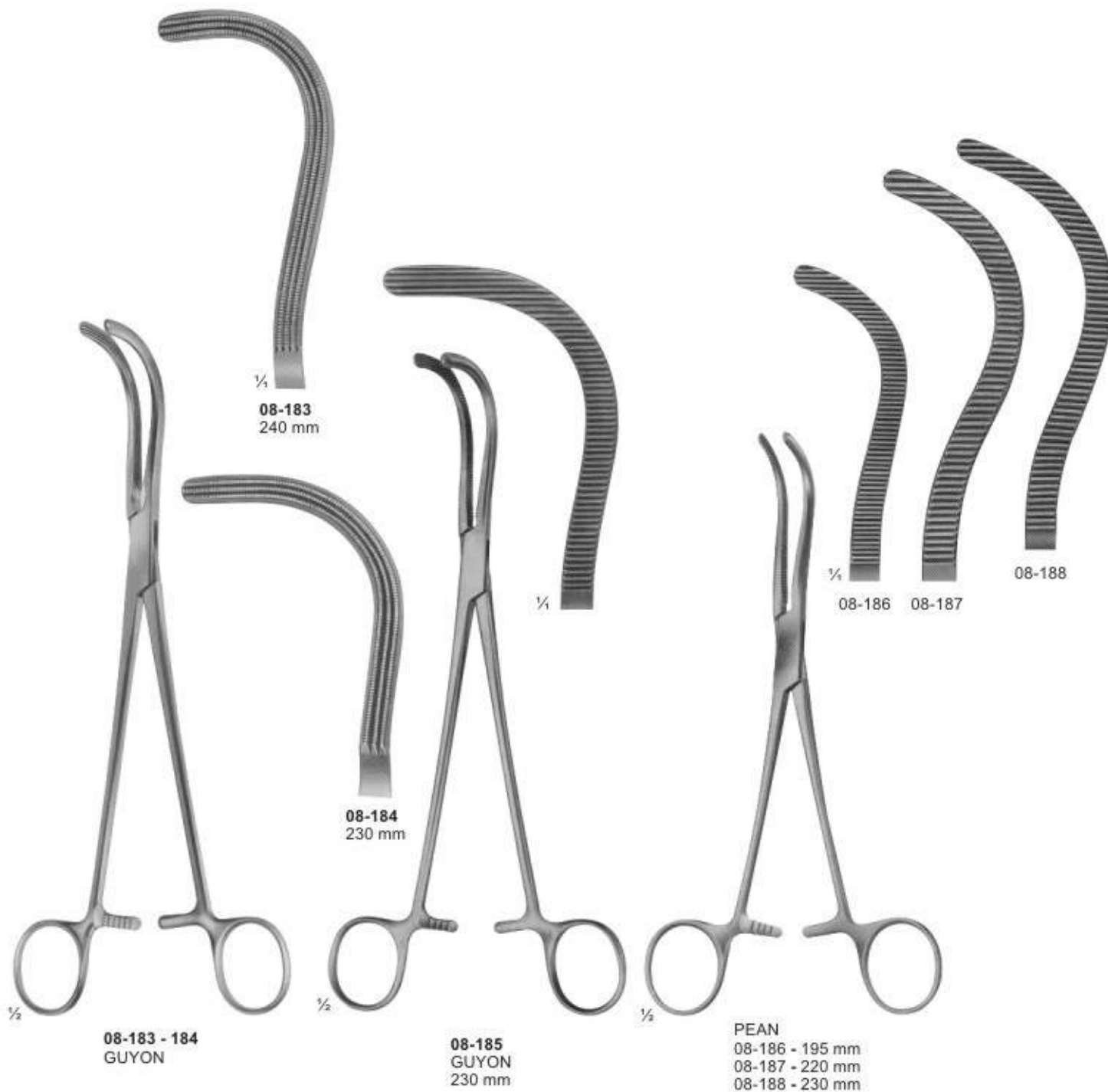

Kidney Stone Forceps Nierensteinzangen



08-189



08-190



08-191



1/4
08-192



08-193



08-194



1/4
08-195



1/2

08-189 - 192
RANDALL
225 mm



1/2

08-193 - 195
RANDALL
190 mm

Bladder Retractors
Blasenwundspreizer

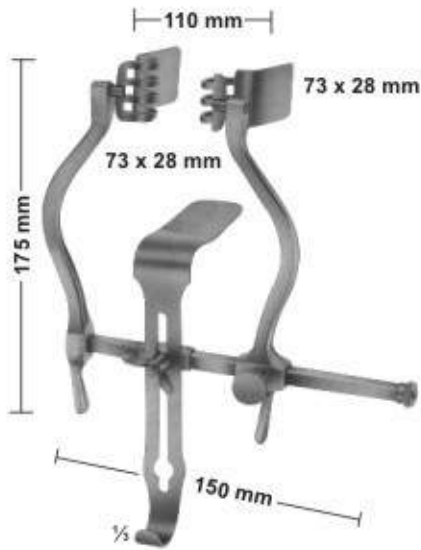

09-101
JUDD-MASSON
 Bladder-and suprapubic
 retractor

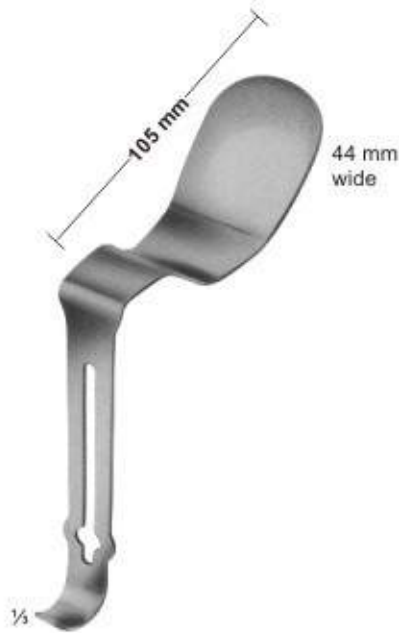

09-102
MILLIN
 Center bladder for
 retro pubic prostatectomy



09-103
MILLIN
 Bladder retractor, complete
 105X45 mm



09-104
LEGUEU
 Bladder retractor
 Center blade
 80 x 31 mm

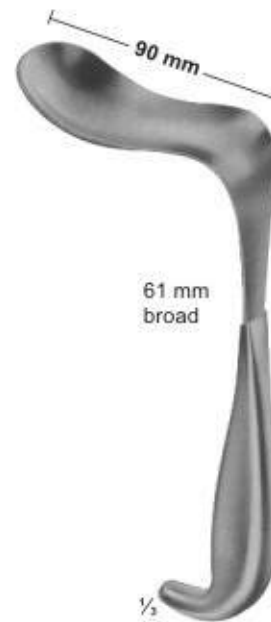

09-105
KOCHER
 Bladder spatula
 235 mm

Trocars Trocare



09-106
KLIMA ROSEGGER
35 X 1,8 mm
Sternal puncture needle

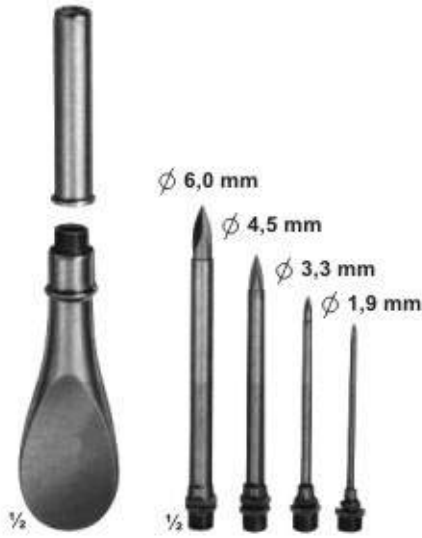

09-107
Universal trocar
with 4 tips



09-108 - 112
Inside diam. Outside diam
09-108 2,2 mm 3,0 mm
09-109 3,0 mm 4,0 mm
09-110 4,0 mm 5,0 mm
09-111 5,0 mm 6,0 mm
09-112 5,5 mm 6,5 mm
for hydrocele and abdominal puncture



09-113 - 116
Inside diam. Outside diam
09-113 2,2 mm 3,0 mm
09-114 3,0 mm 4,0 mm
09-115 4,0 mm 5,0 mm
09-116 5,0 mm 6,0 mm
for abdominal puncture,
with stop-cock and lateral drain



09-117 - 118
Inside diam. Outside diam
09-117 6,5 mm 8,0 mm
09-118 9,0 mm 10,0 mm
Empyema trocar
BUELEU

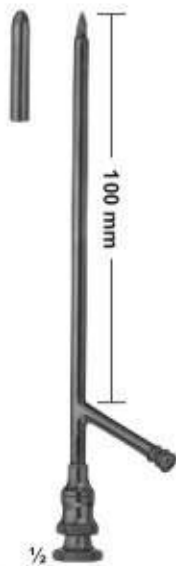

09-119 - 122
Inside diam. Outside diam
09-119 3,0 mm 4,0 mm
09-120 3,6 mm 4,6 mm
09-121 4,3 mm 5,3 mm
09-122 5,0 mm 6,0 mm
Gall bladder trocars
OCHSNER



09-123
PIERCE
Antrum trocar
Ø 4,0 mm



09-124
COAKLEY
Antrum trocar
Ø 3,0 mm

Vaginal Specula- Sets, upper and lower blades
Scheidenspekula-Satze, obere und untere Blätter



10-112 - 114
GRAVE
10-112 75X20 mm
10-113 95X30 mm
10-114 105X33 mm

1/2



10-115 - 116
PEDERSON
10-115 100X22 mm
10-116 120X25 mm

1/2



10-117 - 118
BRIESKY
10-117 72X25 mm / 77X30 mm 140 mm
10-118 75X30 mm / 92X38 mm 170 mm

1/2



10-119 - 120
SIMS
70 X 26 mm / 75 X 30 mm
75 X 30 mm / 80 X 35 mm
80 X 36 mm / 90 X 40 mm
175 mm

1/2



10-121 - 123
SEIDL
10-121 80X8 mm
10-122 80X10 mm
10-123 90X14 mm
For children and infants
170 mm

1/2



10-124
KRISTELLER
70X15 mm, (170 mm)
For children

1/2



10-125 - 127
KRISTELLER
10-125 70X27 mm
10-126 75X30 mm
10-127 90X36 mm
175 mm

1/2

Vaginal Specula- upper and lower blades
 Scheidenspekula-obere und untere Blatter



10-133 75X10 mm
175 mm

10-137 70X15 mm
175 mm

10-134 75X23 mm
180 mm

10-138 70X27 mm
180 mm

10-135 80X25 mm
180 mm

10-139 75X30 mm
180 mm

10-136 100X32 mm
185 mm

10-140 90X36 mm
185 mm

10-128 - 132
KRISTELLER
10-128 110X18 mm
10-129 110X20 mm
10-130 110X27 mm
10-131 110X30 mm
10-132 110X36 mm
220 mm

10-133 - 136
KRISTELLER
Upper blades

10-137 - 140
KRISTELLER
Lower blades

Vaginal Specula
Scheidenspekula

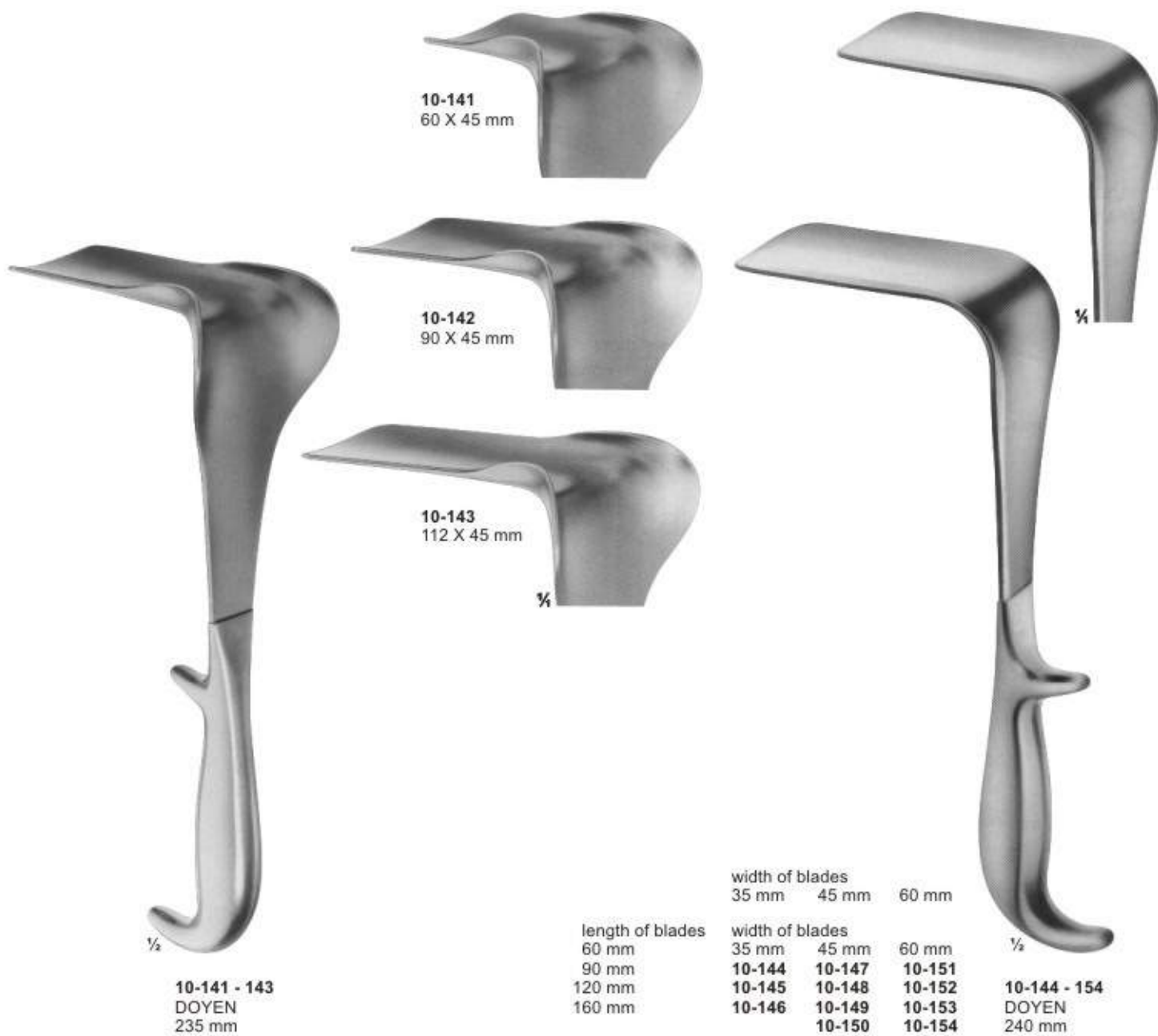

10-141
60 X 45 mm

10-142
90 X 45 mm

10-143
112 X 45 mm

10-141 - 143
DOYEN
235 mm

length of blades
60 mm
90 mm
120 mm
160 mm

width of blades
35 mm 45 mm 60 mm

width of blades
35 mm 45 mm 60 mm
10-144 10-147 10-151
10-145 10-148 10-152
10-146 10-149 10-153
10-150 10-154

10-144 - 154
DOYEN
240 mm

Vaginal Retractors
Vulva-Spreizer



¼
10-155
JOLL (FRIEDMAN)
155 mm



¼
10-156
RICHTER
170 mm



¼
10-157
GELPI
135 mm



¼
10-158
GELPI
175 mm

Uterine Dilators Uterus-Dilatatoren



1/2

11-101 - 143
HEGAR
with very conical point
185 mm

11-101	1	mm	11-123	23	mm
11-102	2	mm	11-124	24	mm
11-103	3	mm	11-125	25	mm
11-104	4	mm	11-126	26	mm
11-105	5	mm	11-127	1	1/2mm
11-106	6	mm	11-128	2	1/2mm
11-107	7	mm	11-129	3	1/2mm
11-108	8	mm	11-130	4	1/2mm
11-109	9	mm	11-131	5	1/2mm
11-110	10	mm	11-132	6	1/2mm
11-111	11	mm	11-133	7	1/2mm
11-112	12	mm	11-134	8	1/2mm
11-113	13	mm	11-135	9	1/2mm
11-114	14	mm	11-136	10	1/2mm
11-115	15	mm	11-137	11	1/2mm
11-116	16	mm	11-138	12	1/2mm
11-117	17	mm	11-139	13	1/2mm
11-118	18	mm	11-140	14	1/2mm
11-119	19	mm	11-141	15	1/2mm
11-120	20	mm	11-142	16	1/2mm
11-121	21	mm	11-143	17	1/2mm
11-122	22	mm			



1/2

11-144 - 152
HEGAR
205 mm

11-144	1+2	mm
11-145	3+4	mm
11-146	5+6	mm
11-147	7+8	mm
11-148	9+10	mm
11-149	11+12	mm
11-150	13+14	mm
11-151	15+16	mm
11-152	17+18	mm

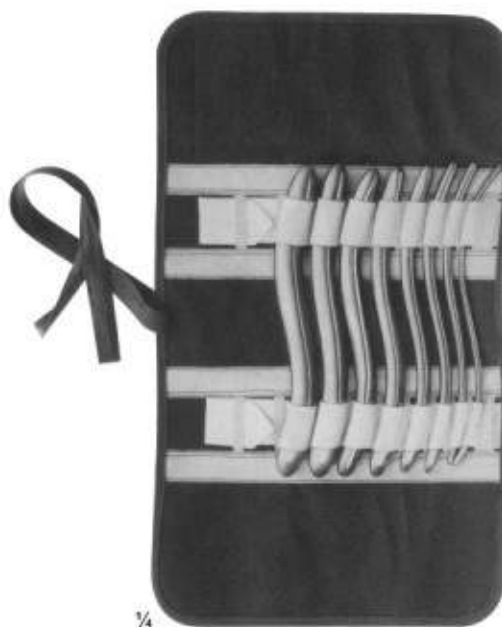

1/4

11-153
HEGAR
Uterine dilator set, in canvas
roll with 8 dilators.

Uterine Probes Uterussonden

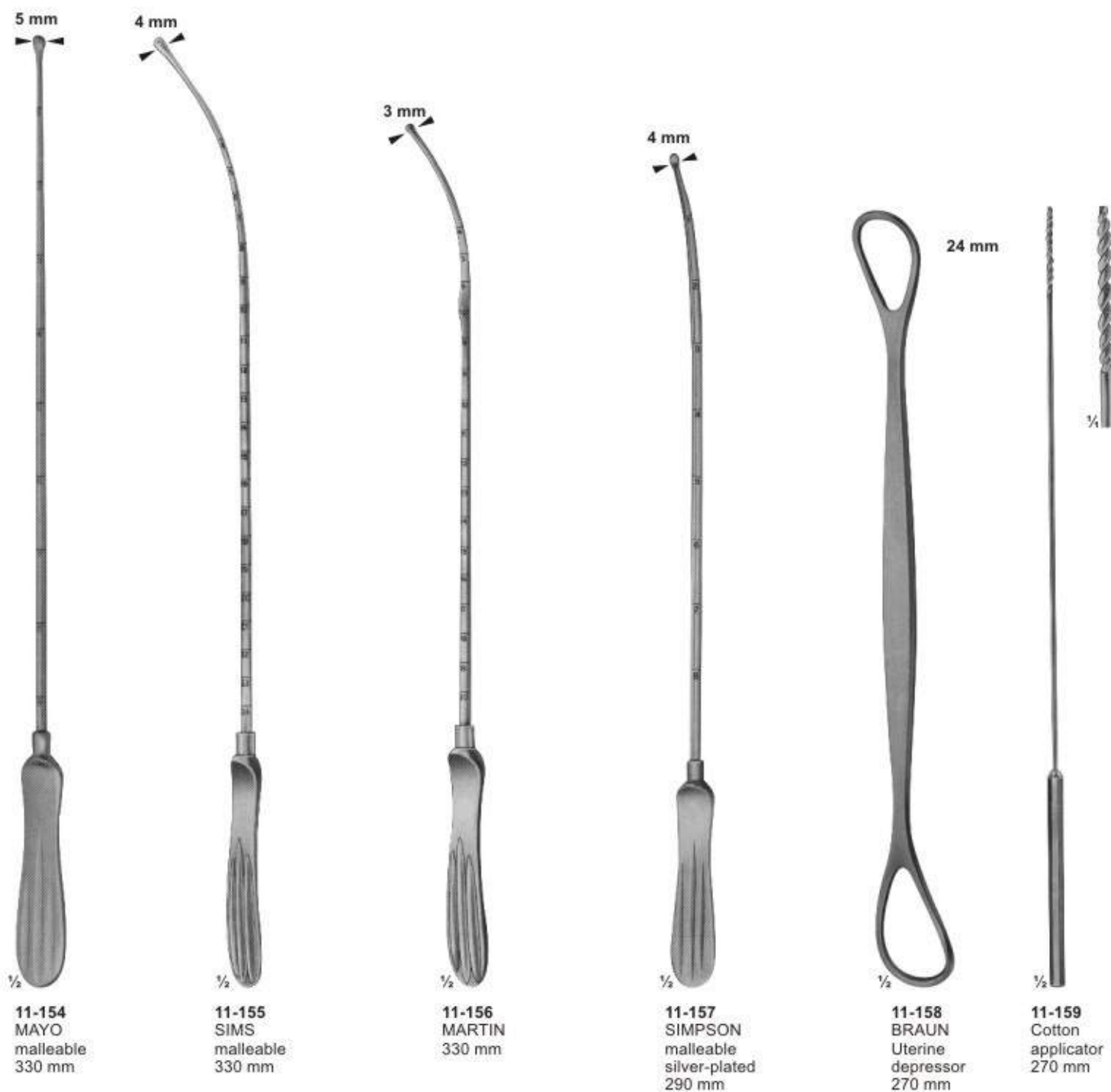

Uterine Dressing Forceps Tamponzangen

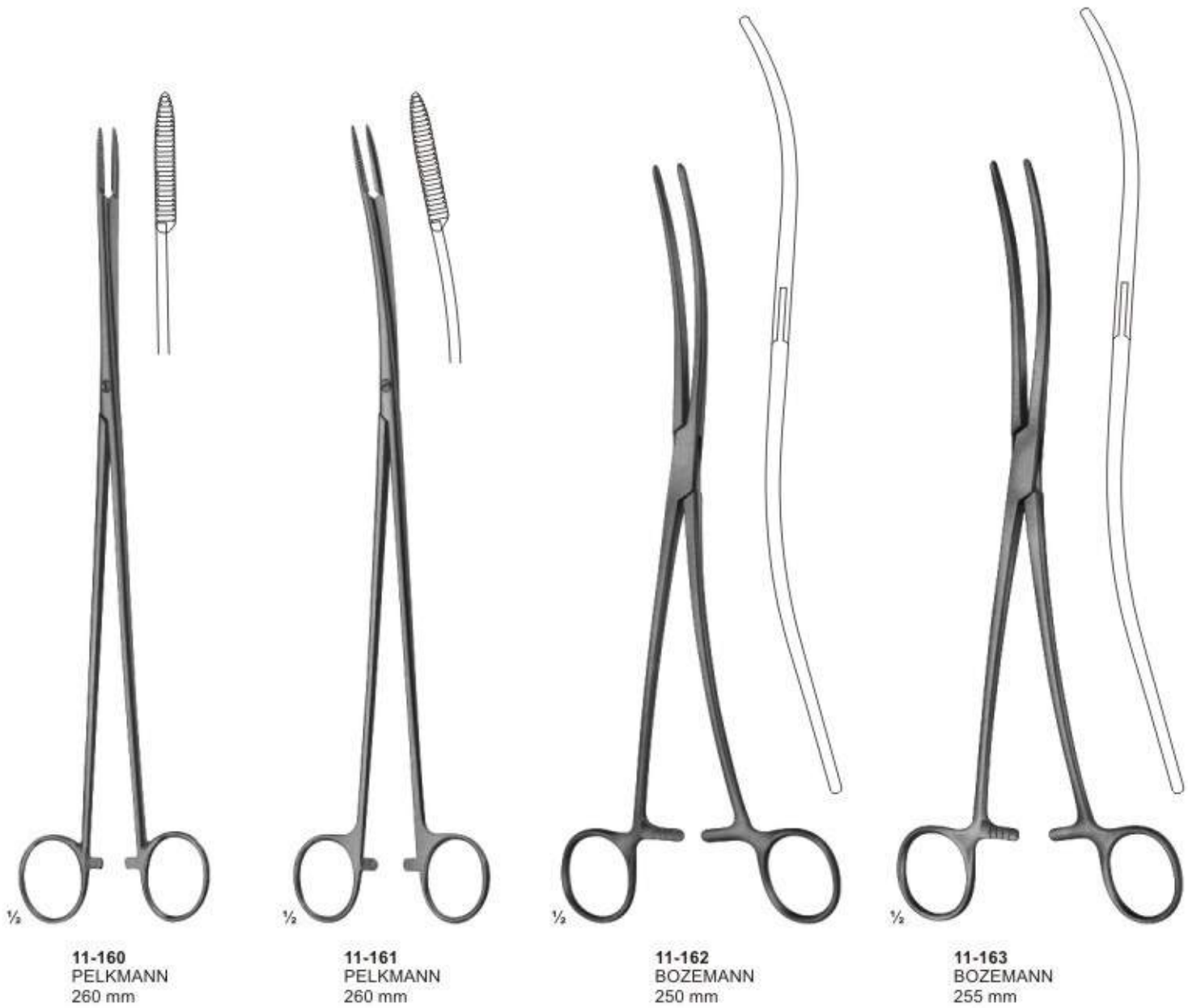

Jaws with longitudinal groove

Polypus-and Ovum Forceps
Polypen- und Ovarienzangen

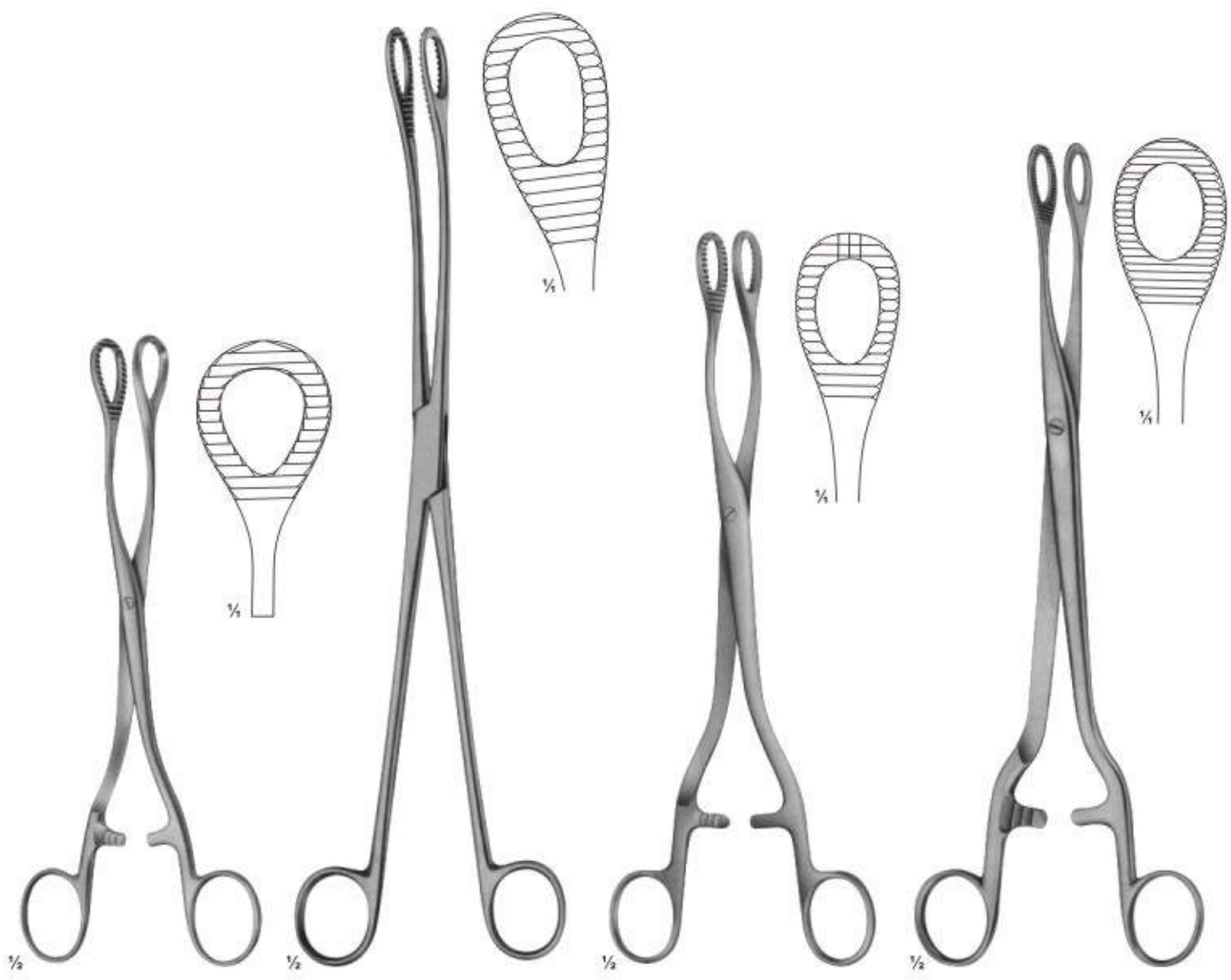

11-164
HEYWOOD-SMITH
200 mm

11-165
KELLY
320 mm

11-166
HEYWOOD-SMITH
250 mm

11-167
NOTO
280 mm

Biopsy Curettes Biopsiekuretten

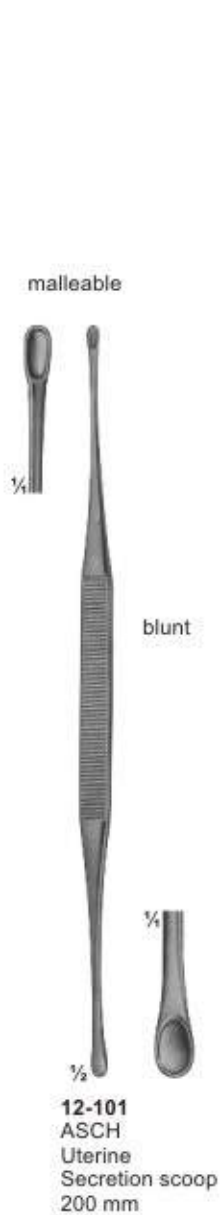

Biopsy Forceps Biopsiezangen

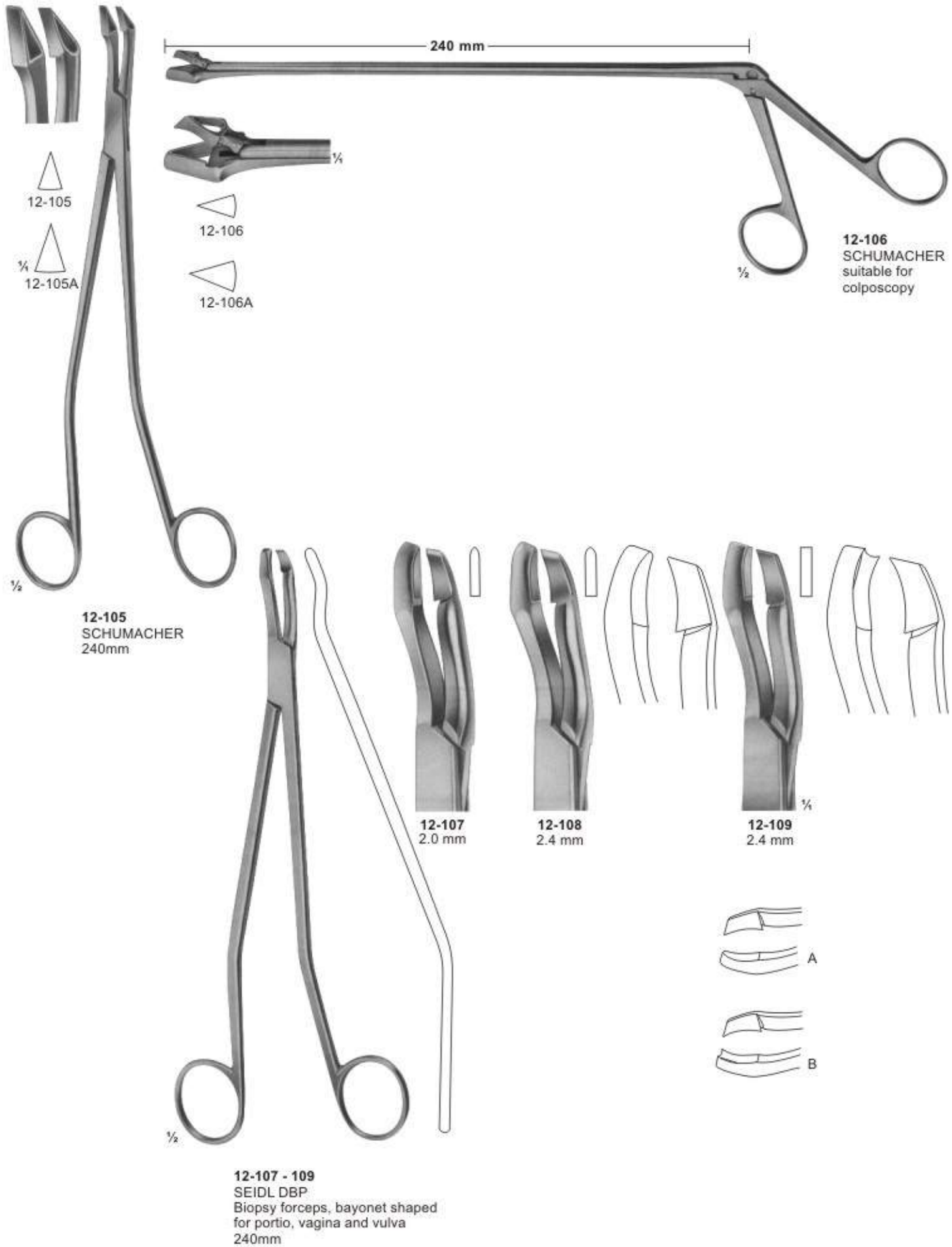

Biopsy Forceps Biopsiezangen

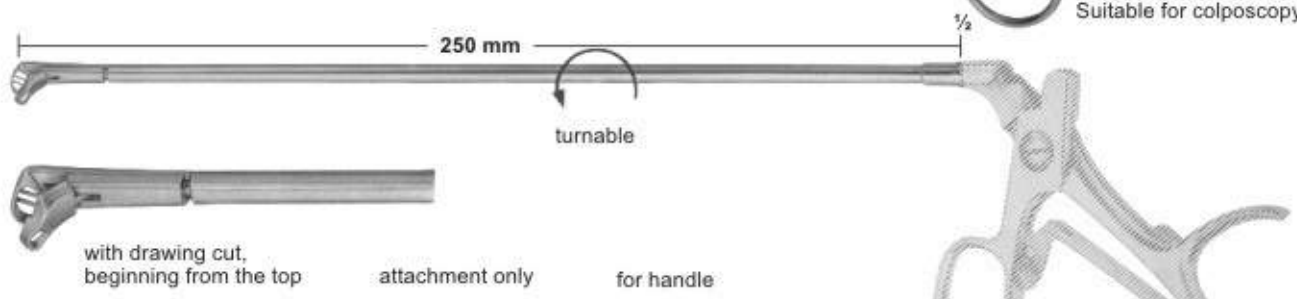
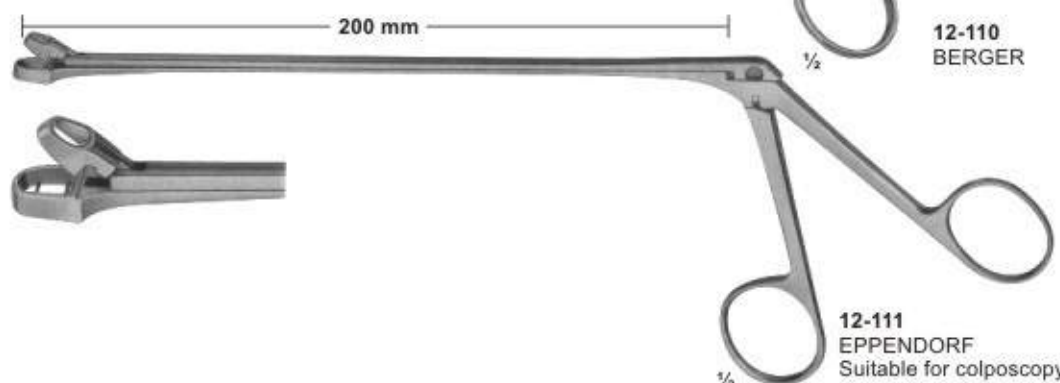
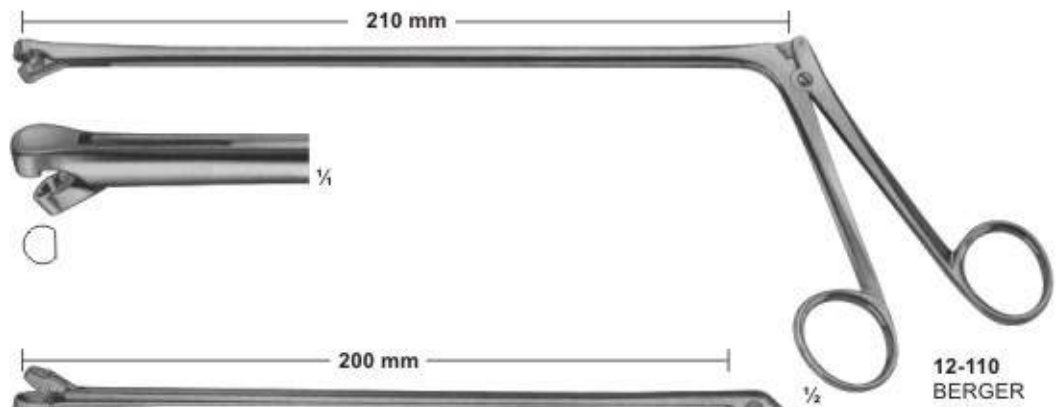

Uterine Scoops Uterusloffel

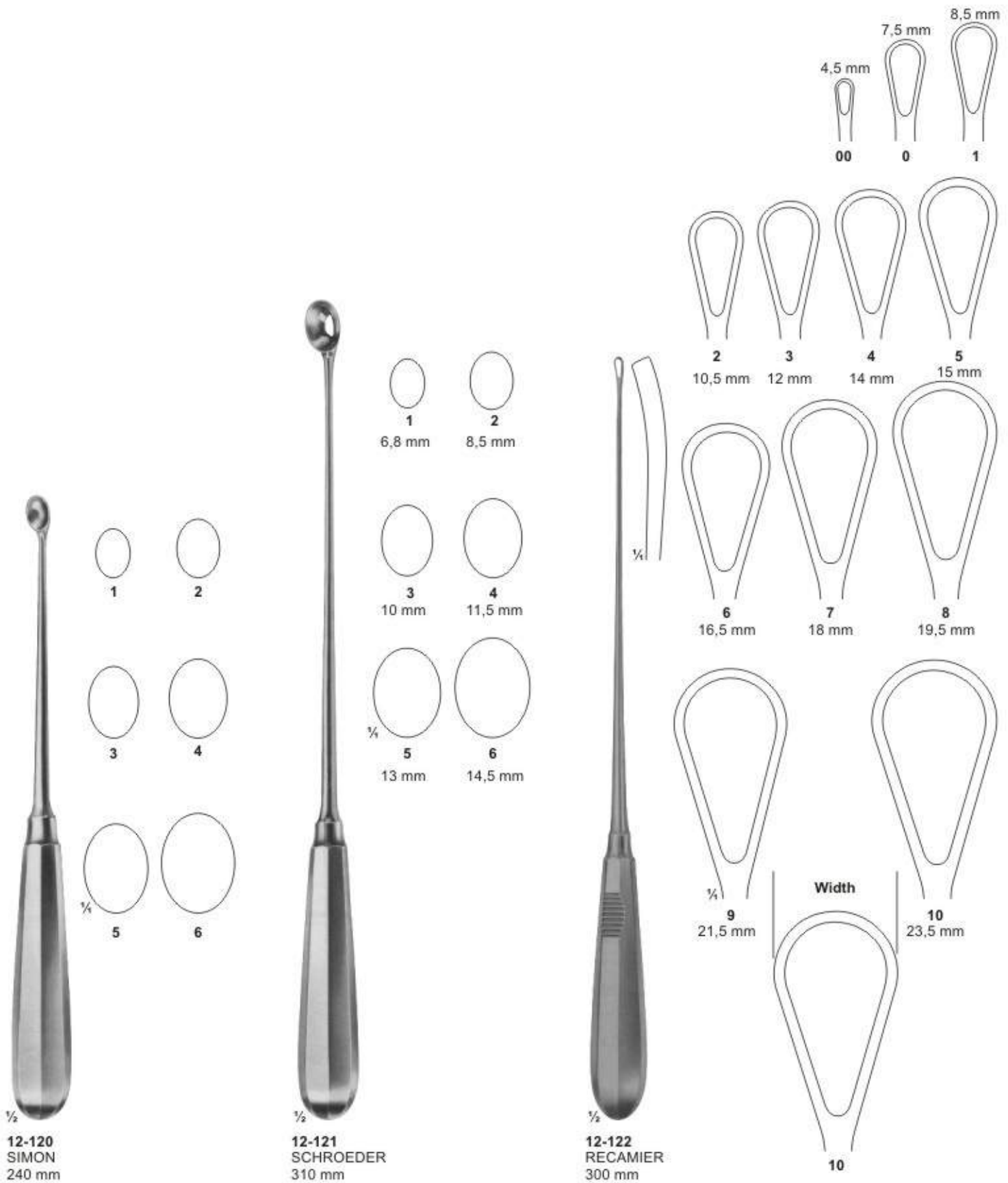

Obstetrical Forceps
Geburtszangen



13-101
NAEGELE
355 mm



13-102
NAEGELE
400 mm



13-103
SIMPSON-BRAUN
305mm

**Obstetrics- Placenta and Ovum Forceps
Geburtshilfe- Plazentnar- und Abortuszangen**

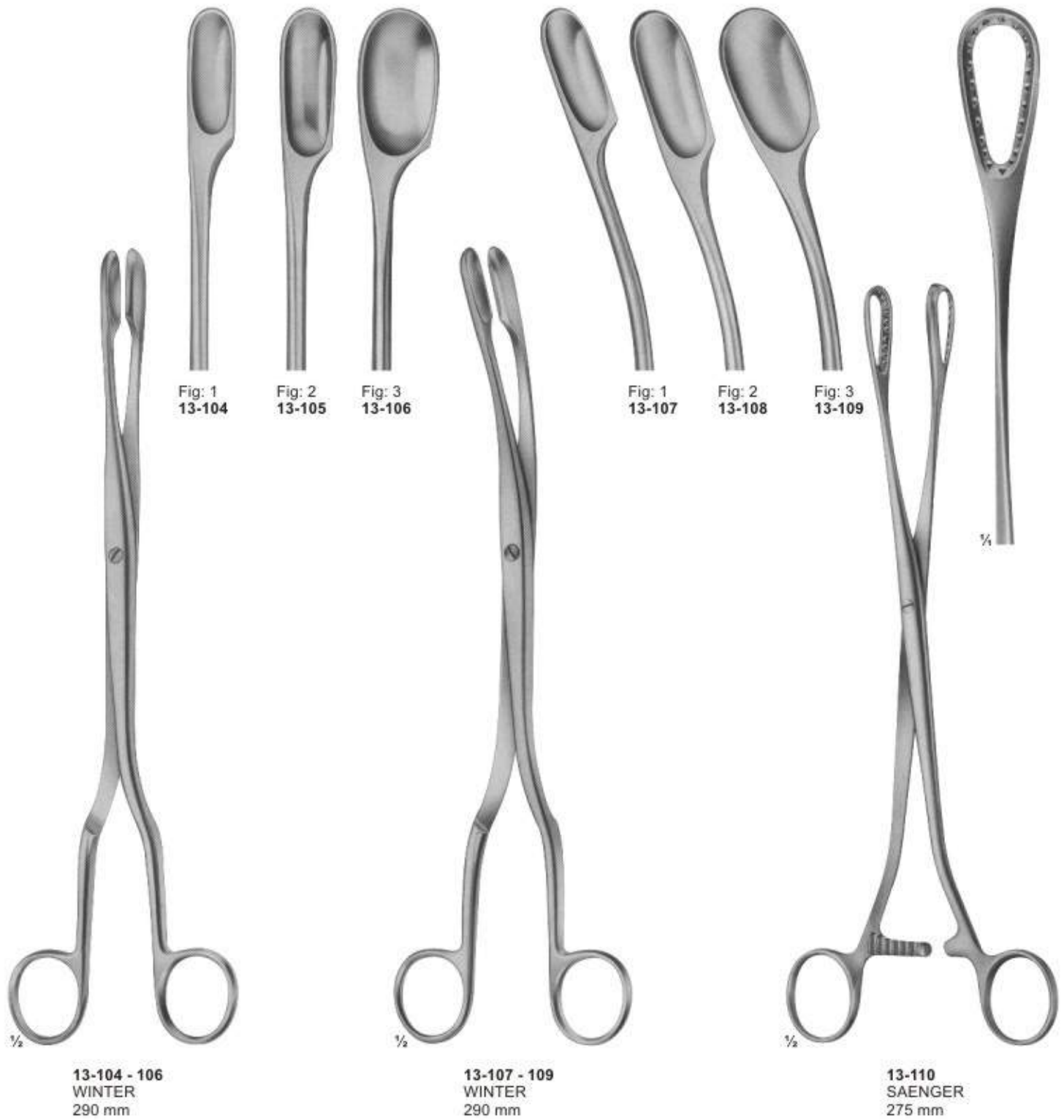

Tound-and Tracheal Hooks and Dilators

Tund-, Trachealhakchen, dilatatoren



13-111
BOSE
165 mm

13-112
BOSE
165 mm



13-113 - 115
180 mm

13-113
sharp



13-114
blunt



13-115
stumpf/blunt



13-116
FINSEN
50 mm



13-117
FINSEN
70 mm



13-118
TROUSSEAU
120 mm



13-119
LABORDE
125 mm



13-120
LABORDE
strong pattern
135 mm



13-121
Cleaning Brush
for tracheal tubes
285 mm

Vascular Spatulas GefaBspatel

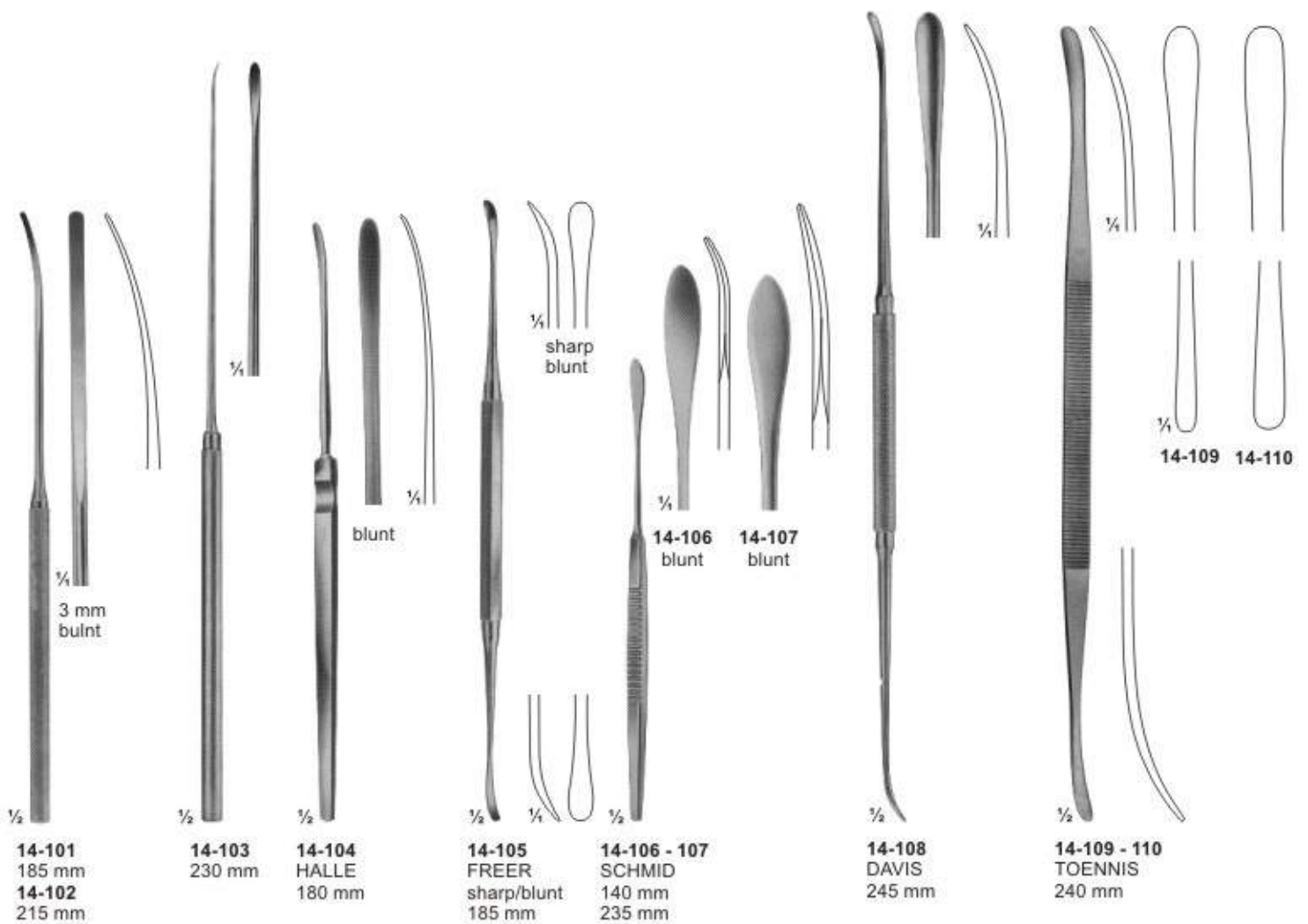

ATRAUMATA
Forceps
Pinzetten

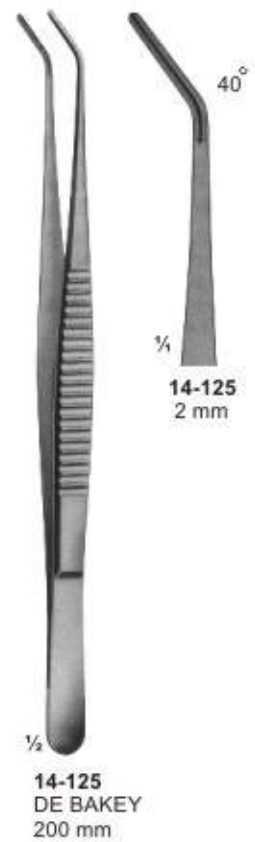
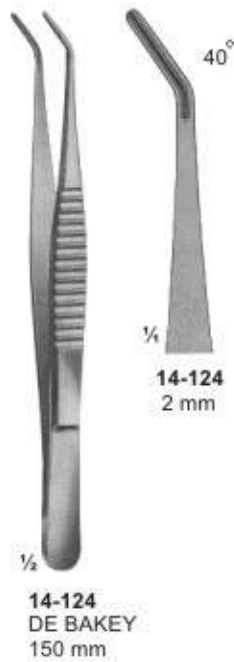
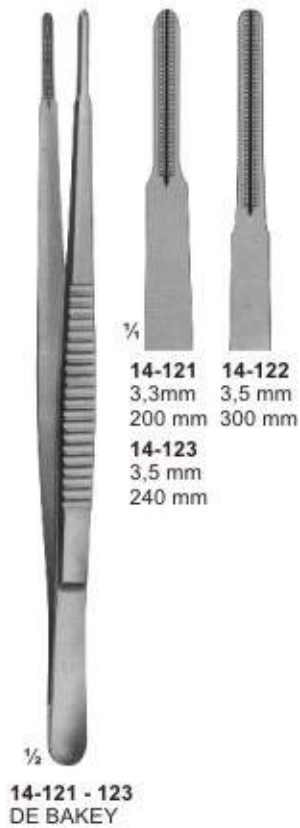
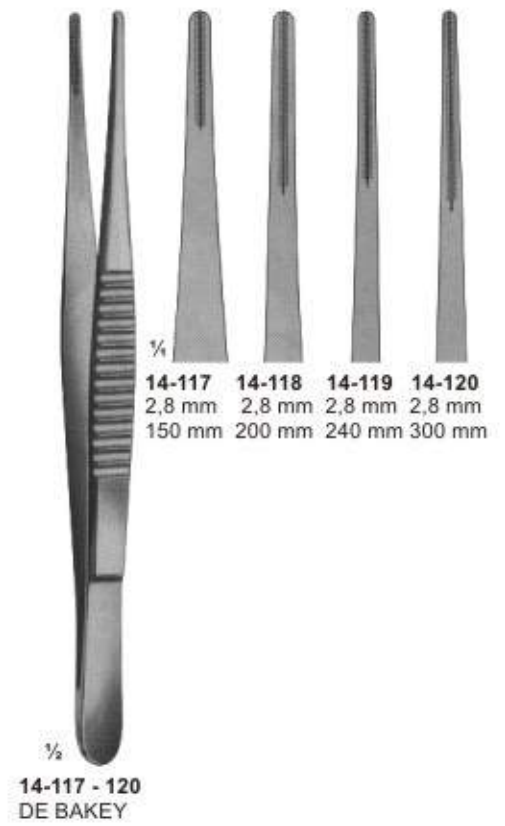
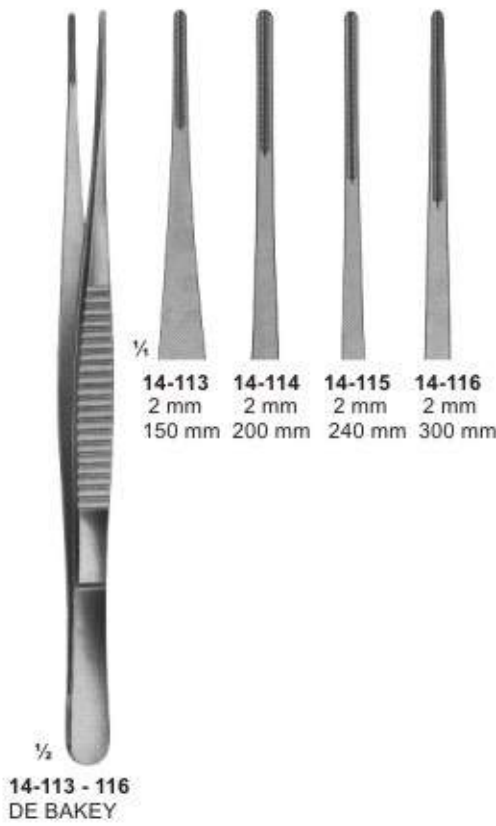
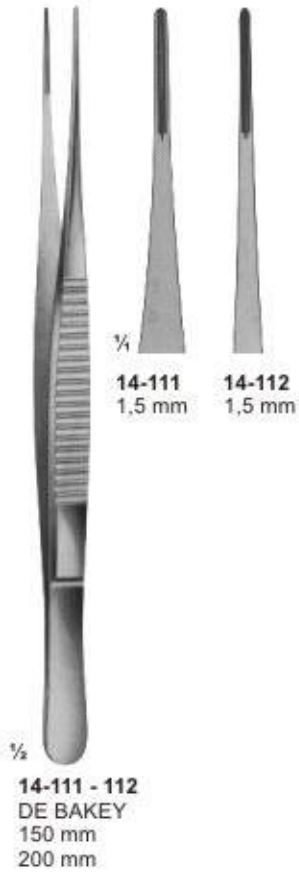

ATRAUMATA

Anastomosis- and Multi- Purpose- Clamps- Pediatric types Anastomosen- und Mehrzweckklemmen- Kinder- Modelle

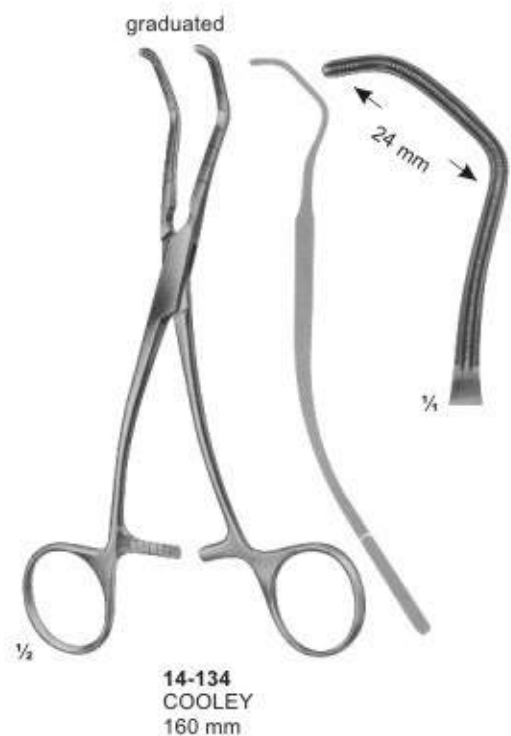
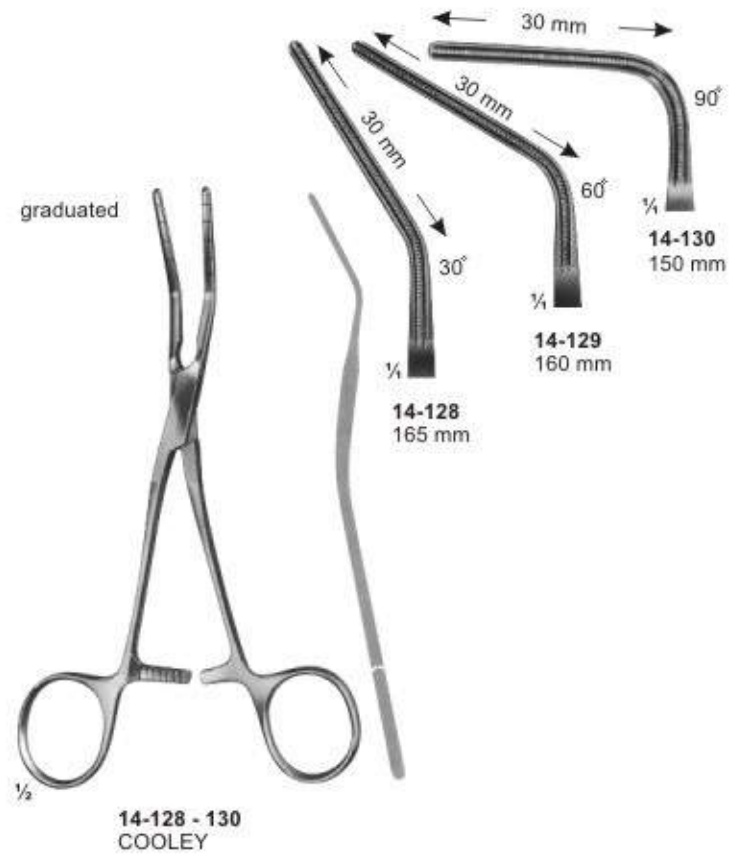
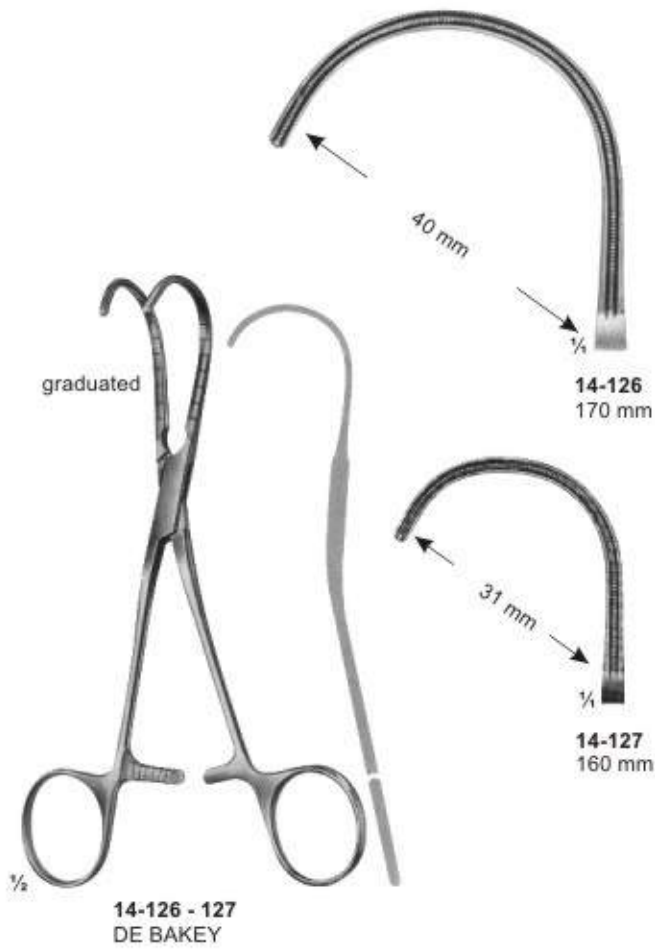

ATRAUMATA
Coarctation Clamps, Patent-Ductus & Peripheral-Vascular Clamps
Coarctationsklemmen, Patent-Ductus und
Peripheralklemmen

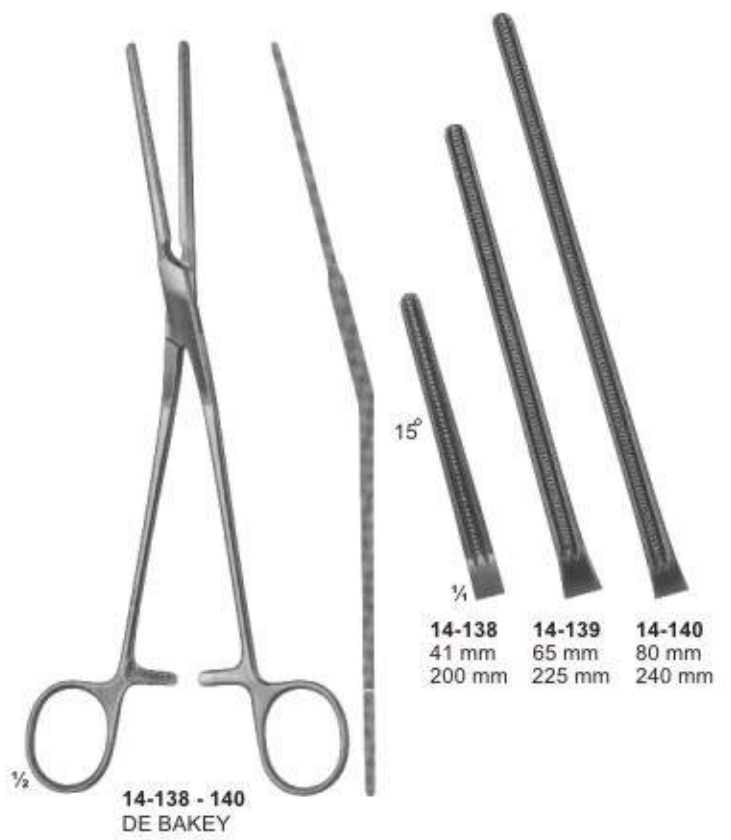

Aorta- Anastomosis Clamps
Aorta- Anastomosenklemmen

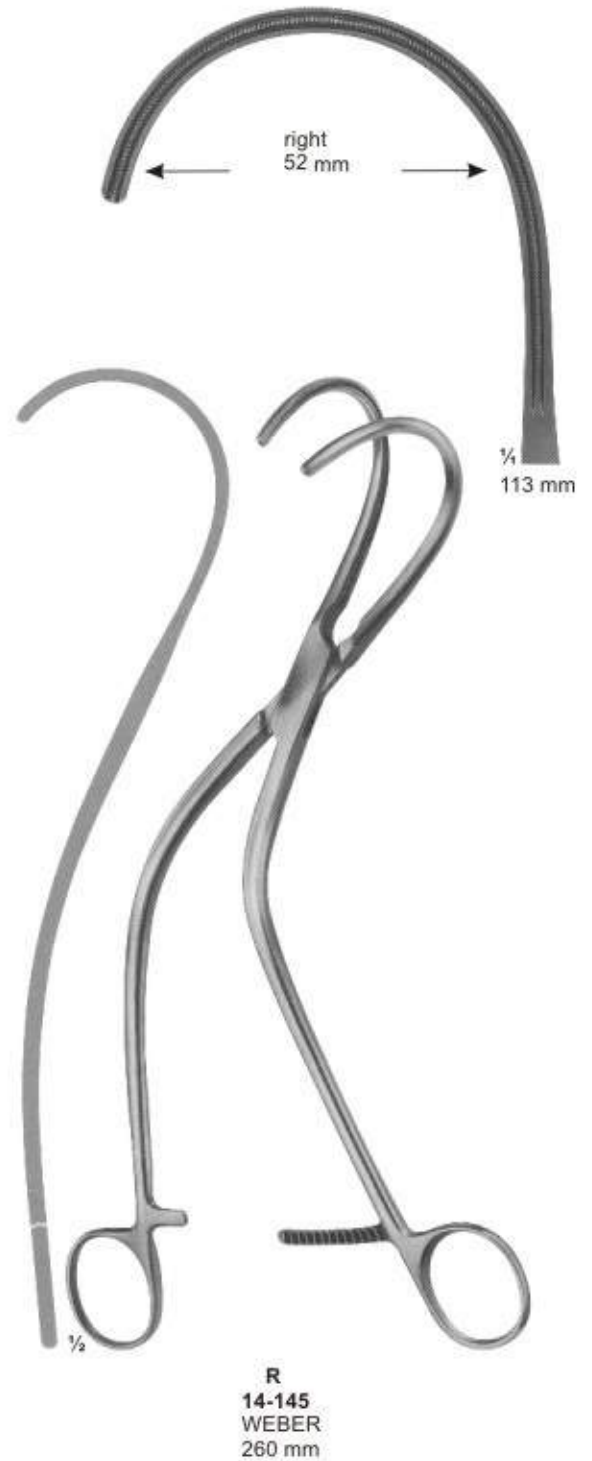
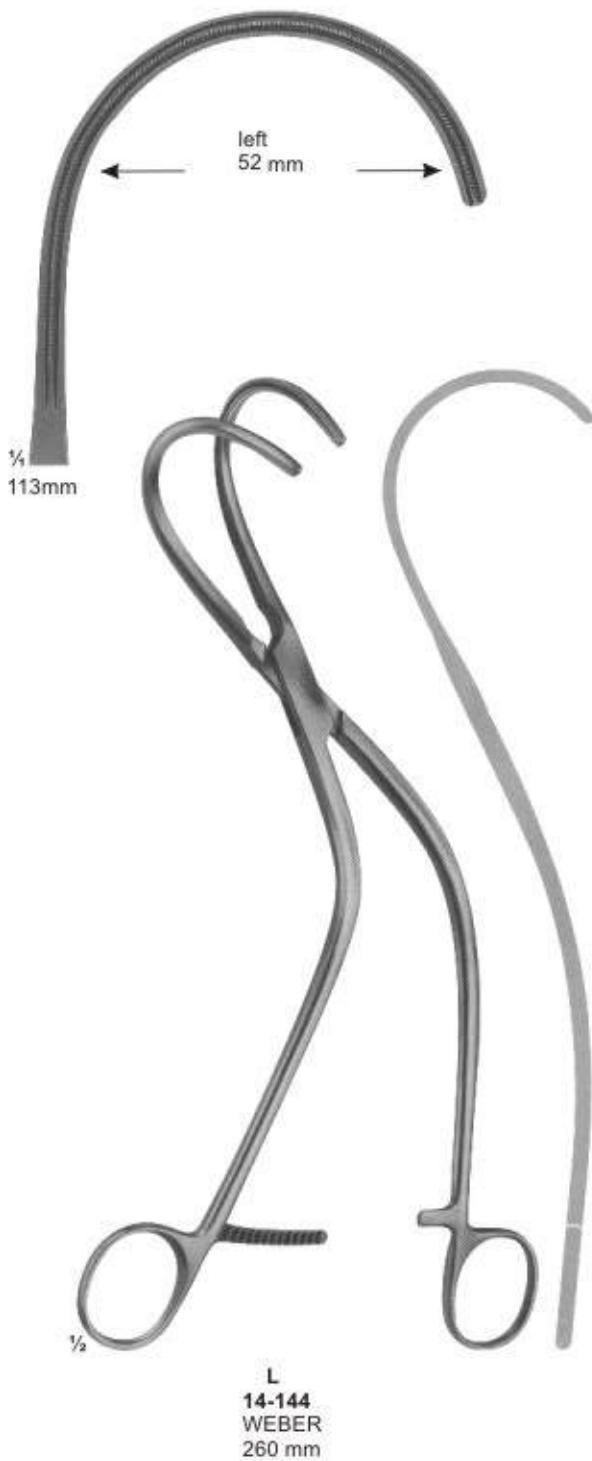

Multi- Purpose-Clamps Mehrzweckklemmen



14-146 - 149
DE BAKEY

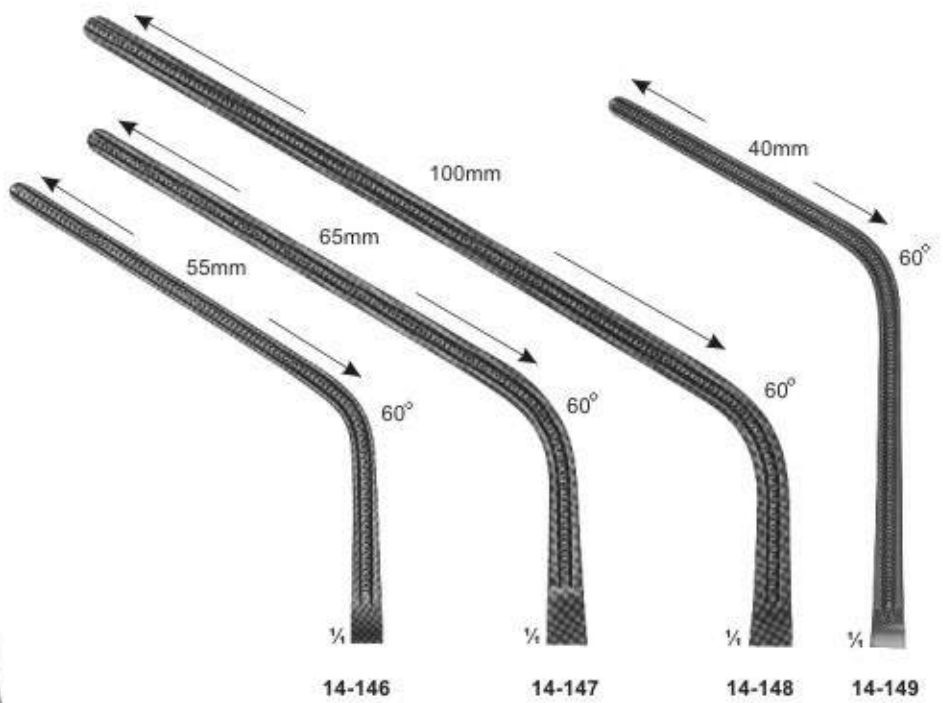

Total Length:	230 mm	280 mm	305 mm	240 mm
Length of jaws:	85 mm	100 mm	135 mm	93 mm



14-150 - 153
DE BAKEY

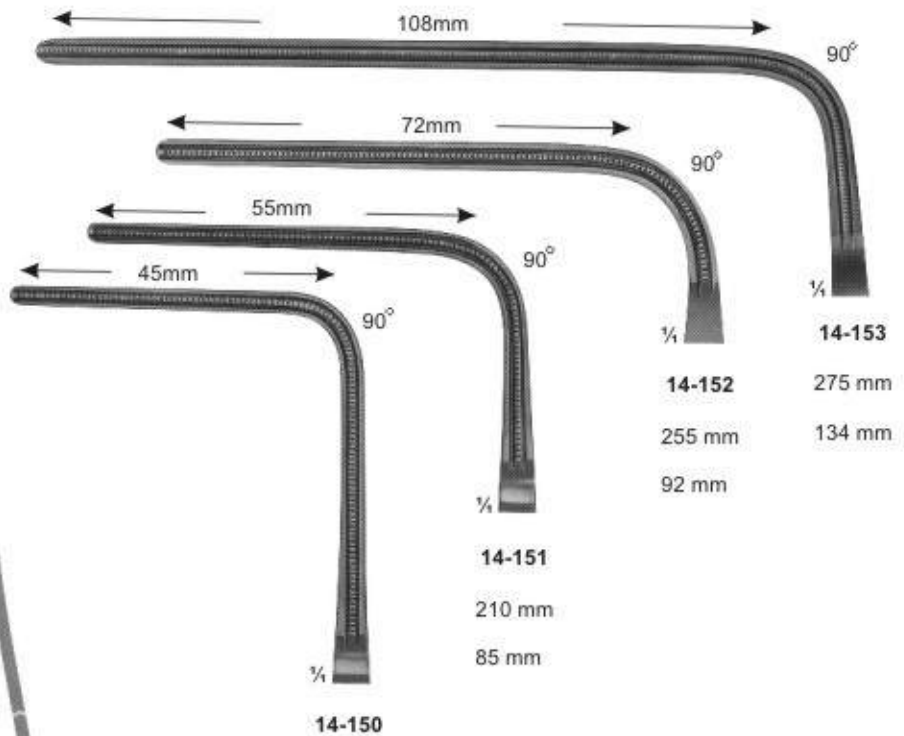

Total Length:	225 mm
Length of jaws:	93 mm

Sternum Instruments and Rib Shears Sternum Instrumente und Rippenscheren



14-154
SCHUMACHER
Sternum shears
210 mm



14-155
LEBSCHE
Sternum chisel
200 mm



14-156
230 mm



14-157
COLLIN
195 mm



14-158
GLUCK
190 mm



14-159
BETHUNE
340 mm



14-160
BRUNNER
Universal pattern
340 mm



14-161
GIERTZ-STILLE
250 mm

Rib Spreaders Rippensperrer

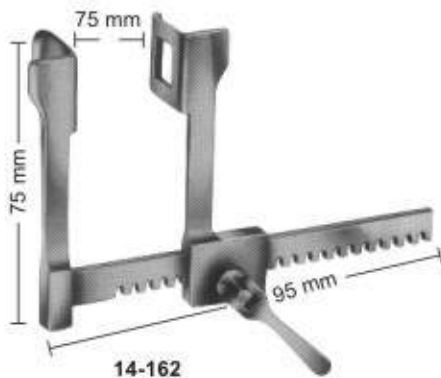

14-162
FINOCHIETTO
Blades
18X21 mm

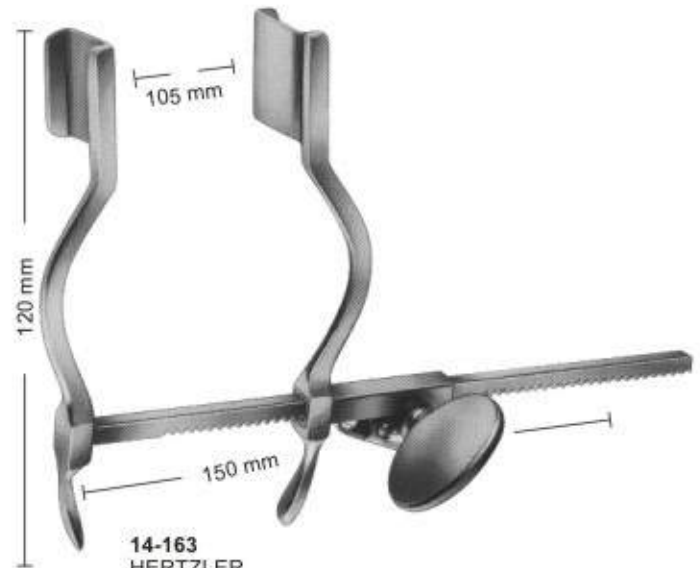

14-163
HERTZLER
Blades
20X25 mm

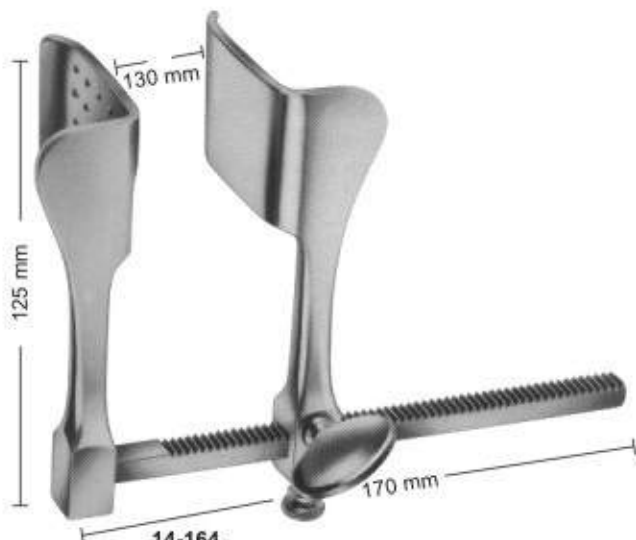

14-164
TUFFIER
Blades
43X53 mm

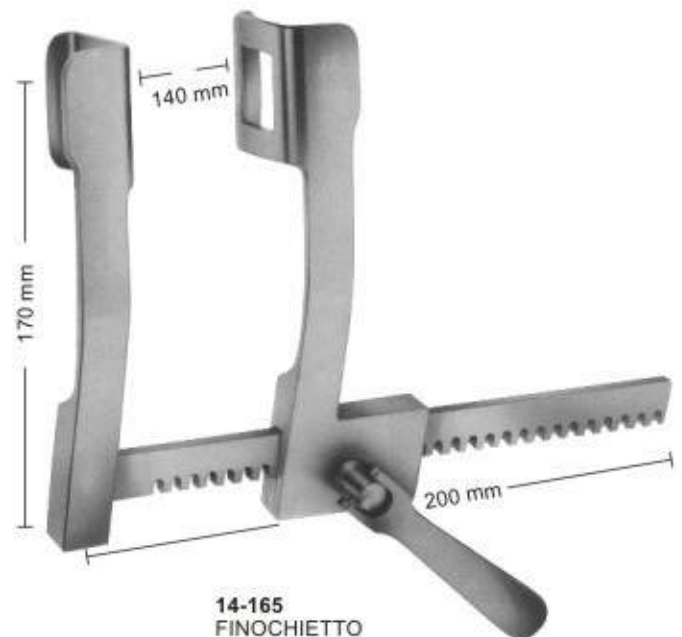

14-165
FINOCHIETTO
Blades
36X45 mm

Rib Spreaders-and Contractors Rippensperrer und - Kontraktoren



1/2

14-166
SELLORS
Rib spreader-and contractor
with swivel blades
200 mm



1/2

14-167
BAILEY
150 mm



14-168
for children

14-169
for adults

1/2

14-168 - 169
BAILEY
200 mm

130° upwards cutting

15-101
1 mm



KERRISON - JACOBY

FERRIS-SMITH-KERRISON

15-102
2 mm



15-103
3 mm



15-104
4 mm



15-105
5 mm

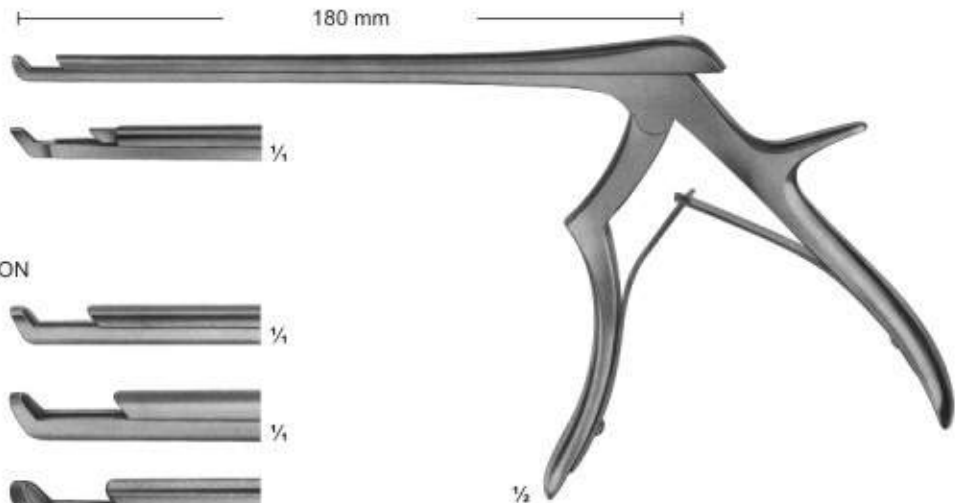

15-101 - 105

90° upwards cutting

KERRISON - JACOBY

15-106
1 mm



15-107
2 mm



FERRIS-SMITH-KERRISON

15-108
3 mm



15-109
4 mm



15-110
5 mm

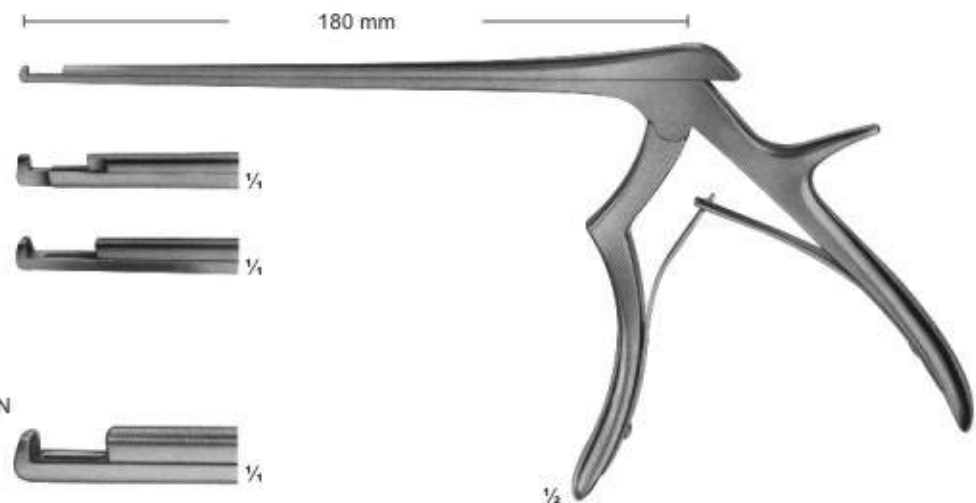

15-106 - 110

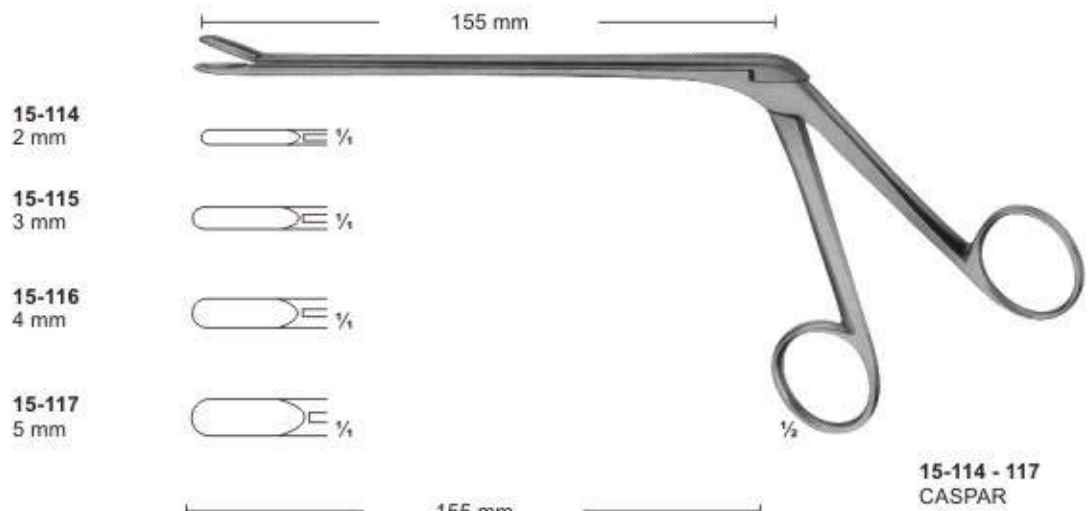
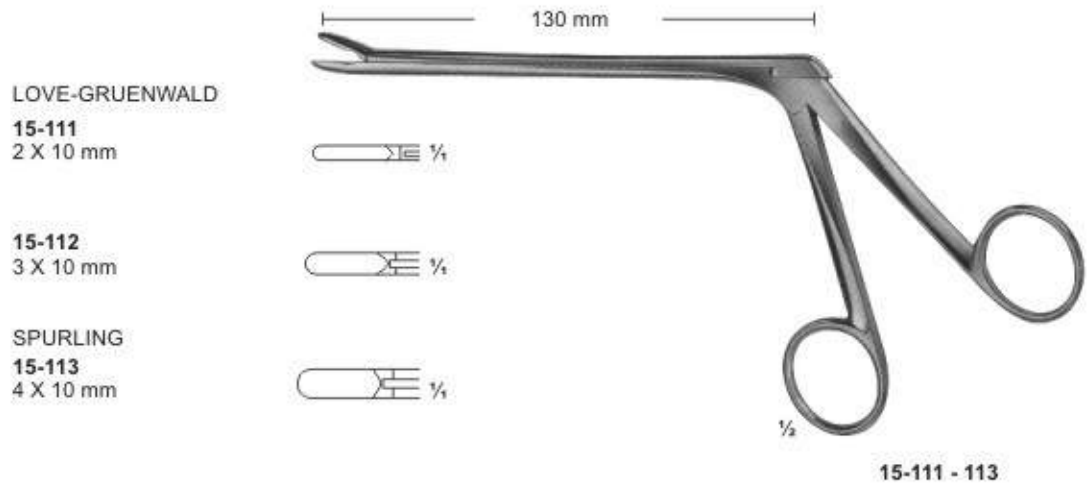

150°

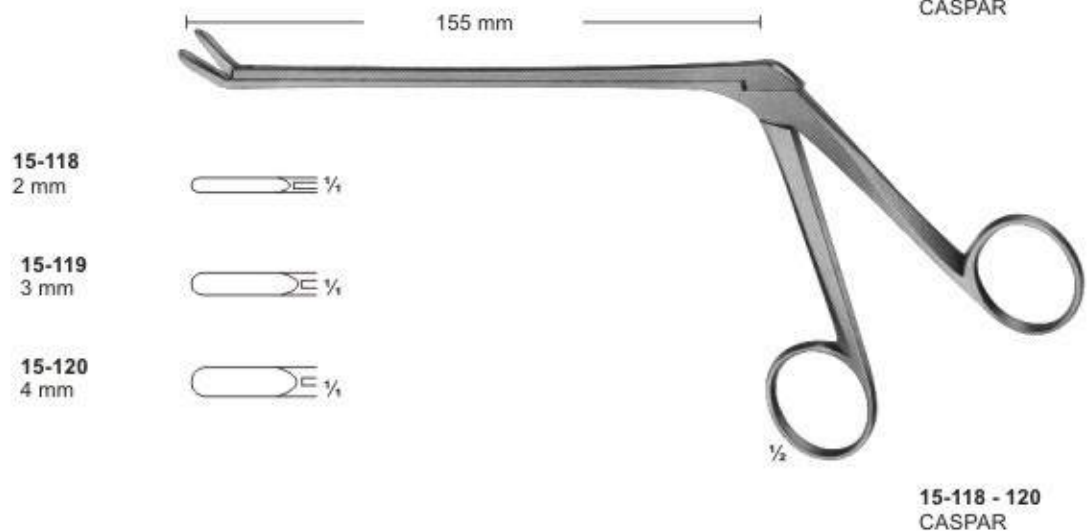

Elevators and Bone Levers

Elevatoren und Knochenhebel

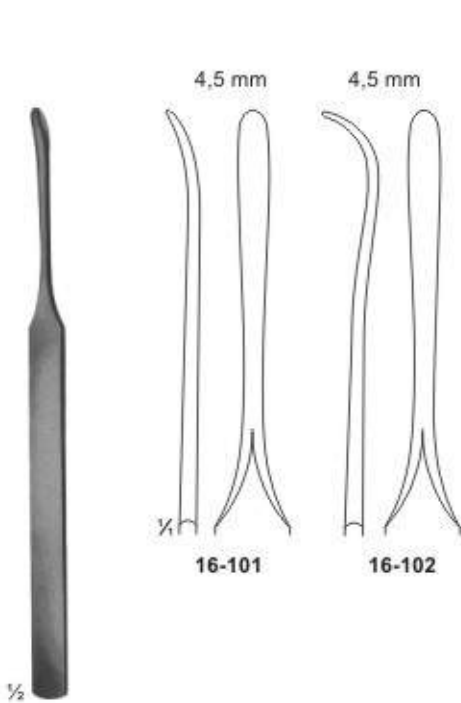

16-101 - 102
KONIG
155 mm



16-103
WILLIGER
165 mm

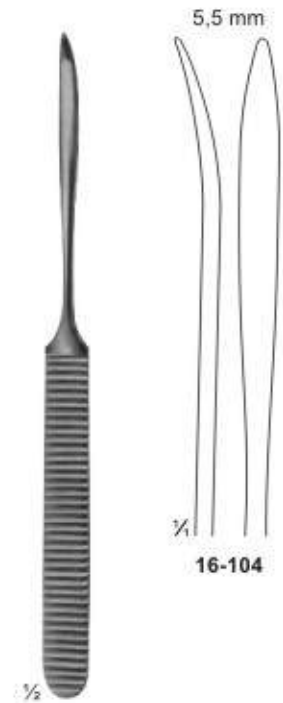

16-104
WILLIGER
170 mm

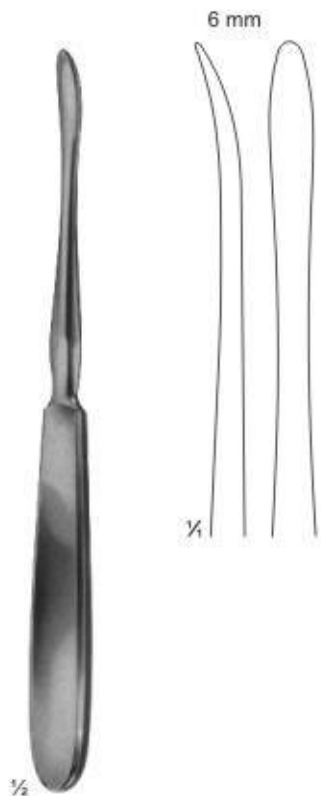

16-105
QUERVAIN
195 mm

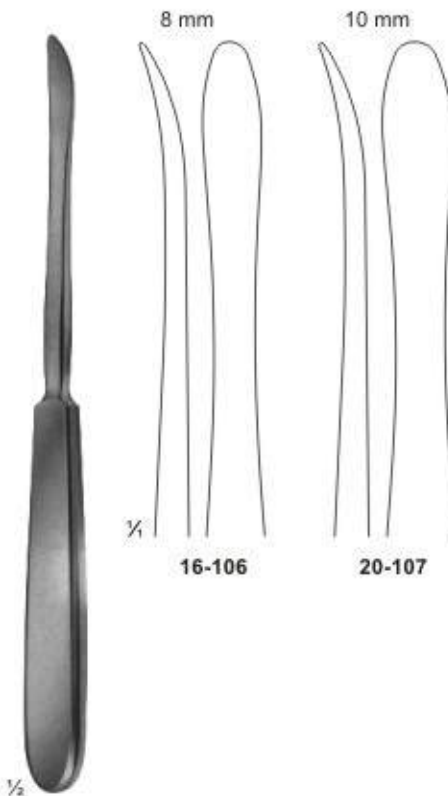

16-106 - 107
LANGENBACK
195 mm

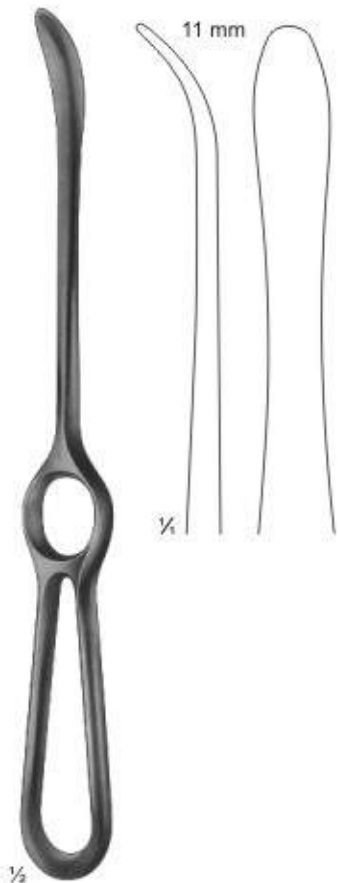

16-108
LANGENBACK
230 mm

Bone Levers
Knochenhebel





16-117 - 118
PARTSCH
150 mm



16-119
PARTSCH mod. LANGE
145 mm



16-120
MC KENTY
155 mm

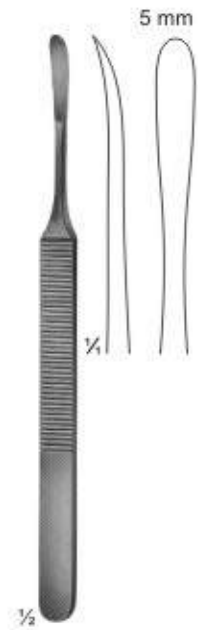

16-121
KOENIG
155 mm

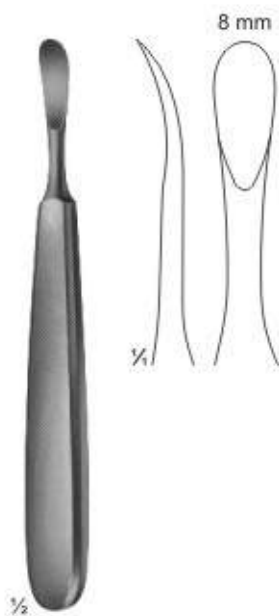

16-122
TRELAT
150 mm

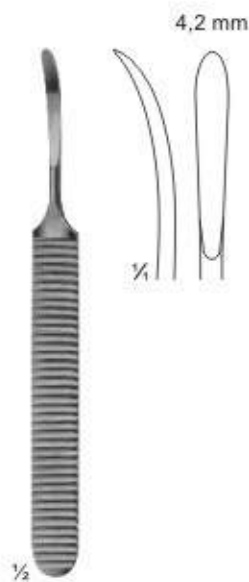

16-123
WILLIGER
140 mm

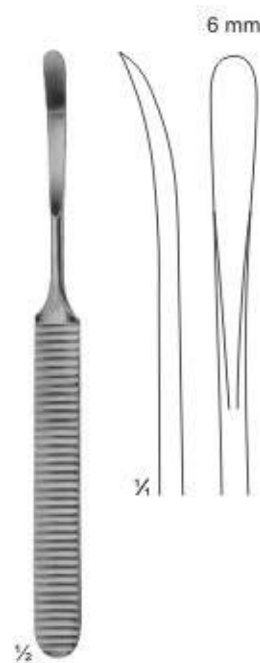

16-124
WILLIGER
160 mm

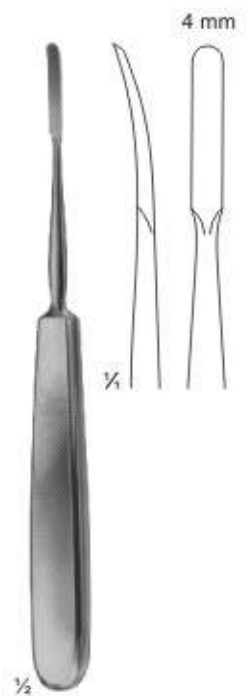

16-125
JOSEPH
170 mm

Bone File and Rasps Knochen-Feilen und - Raspein

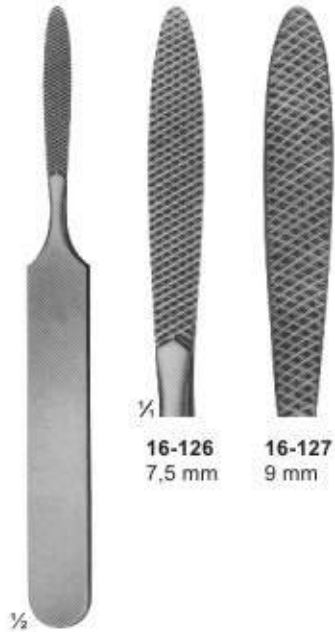

16-126
JOSEPH
fine, chequered

16-127
coarse, chequered
165 mm

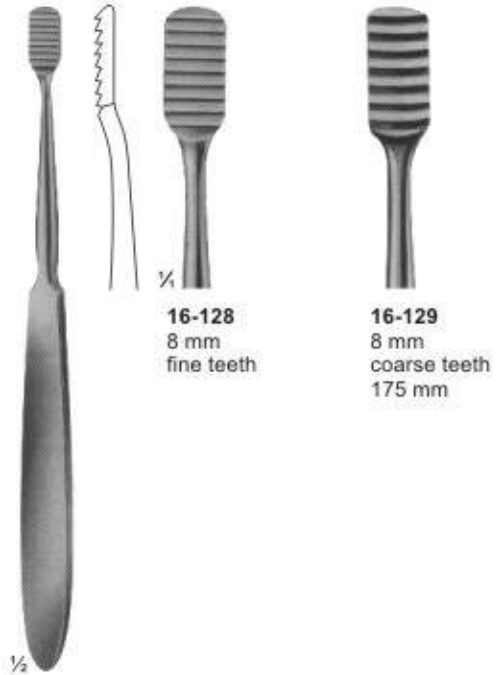

16-128 - 129
LEWIS



16-130
MALTZ
down stroke
180 mm



16-131 - 132
AUFRICHT
up stroke
16-132
down stroke
220 mm



16-133
GALLAHER
190 mm

Bone Currettes
Scharfe Loffel



16-134
JACOBSON
140 mm



16-135
MARTINI
140 mm



16-137
MARTINI
140 mm



16-138
WILLIGER
145 mm



16-139
JANSEN
160 mm



16-140
BARTH
180 mm



16-141
VOLKMANN
130 mm



16-142
VOLKMANN
145 mm



16-143
VOLKMANN
170 mm

Mallets Weights refer to the heads of the mallets
Hammer Die Gewichtsangaben beziehen sich auf
den Kopf des jeweiligen Hammers



17-101
MEAD
185 g
with interchangeable
plastic disks
190 mm
17-102
pair of spare disks



17-103
140 g
with interchangeable
plastic disks
185 mm
17-104
pair of spare disks



17-105
COTTLE
140 g
1 Side Flat
1 Side convex
185 mm



17-106
165 g
lead filled head
190 mm

Osteotomes, Chisels and Gouges

Osteotome, Flach- und Hohlmeißel



17-107
MANNERFELT
Gouge
155 mm

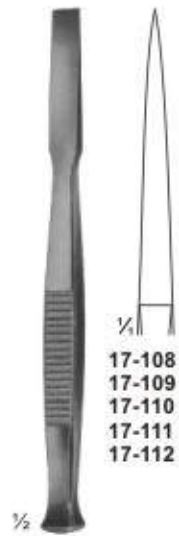

17-108 - 112
Osteotomes
140 mm

- 17-108 4 mm
- 17-109 6 mm
- 17-110 8 mm
- 17-111 10 mm
- 17-112 12 mm



17-113 - 117
Chisels
140 mm

- 17-113 4 mm
- 17-114 6 mm
- 17-115 8 mm
- 17-116 10 mm
- 17-117 12 mm

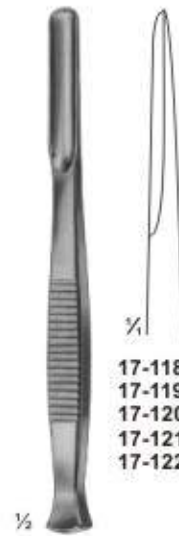

17-118 - 122
Gouges
140 mm

- 17-118 4 mm
- 17-119 6 mm
- 17-120 8 mm
- 17-121 10 mm
- 17-122 12 mm



PARTSCH
17-123 - 126
Chisels
140 mm

- 17-123 3 mm
- 17-124 4 mm
- 17-125 5 mm
- 17-126 6 mm

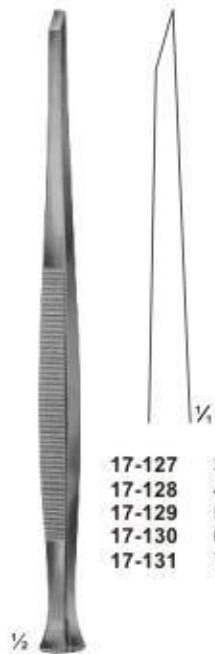

PARTSCH
17-127 - 131
Chisels
170 mm

- 17-127 3 mm
- 17-128 4 mm
- 17-129 5 mm
- 17-130 6 mm
- 17-131 7 mm

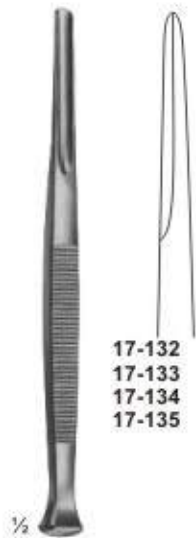

PARTSCH
17-132 - 135
Gouges
140 mm

- 17-132 3 mm
- 17-133 4 mm
- 17-134 5 mm
- 17-135 6 mm

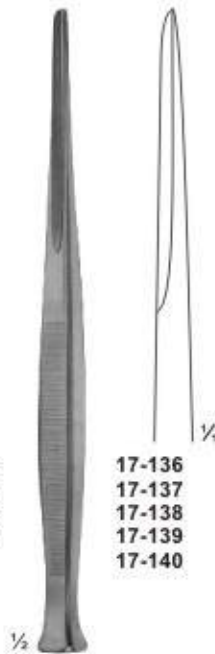

PARTSCH
17-136 - 140
Gouges
170 mm

- 17-136 3 mm
- 17-137 4 mm
- 17-138 5 mm
- 17-139 6 mm
- 17-140 7 mm



LUCAS
17-141 - 142
Chisels
160 mm

- 17-141 4 mm
- 17-142 6 mm



LUCAS
17-143 - 144
Gouges
160 mm

- 17-143 3 mm
- 17-144 5 mm

Reposition Forceps, Bone Holding Forceps
 Repositionszangen, Knochenhaltezangen



17-145
 Patella forceps
 185 mm



17-146
 Forceps with
 ratchet fixation
 140 mm



17-147
 Forceps with
 thread fixation
 170 mm



17-148
 Forceps with
 thread fixation
 235 mm

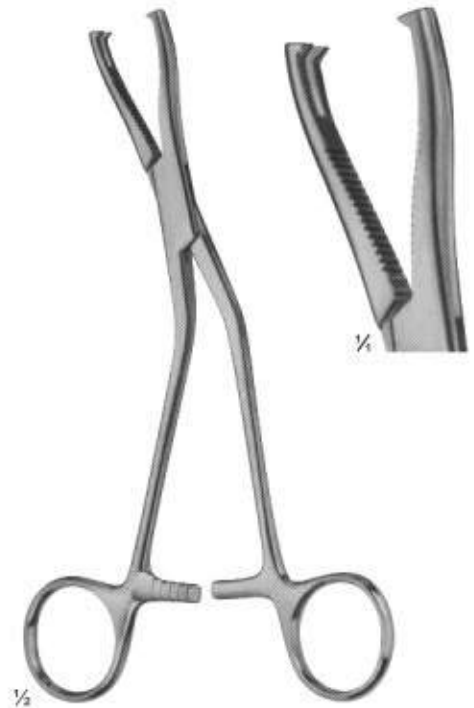

17-149
 DINGMANN
 185 mm

Bone Holding Forceps Knochenhaltezangen

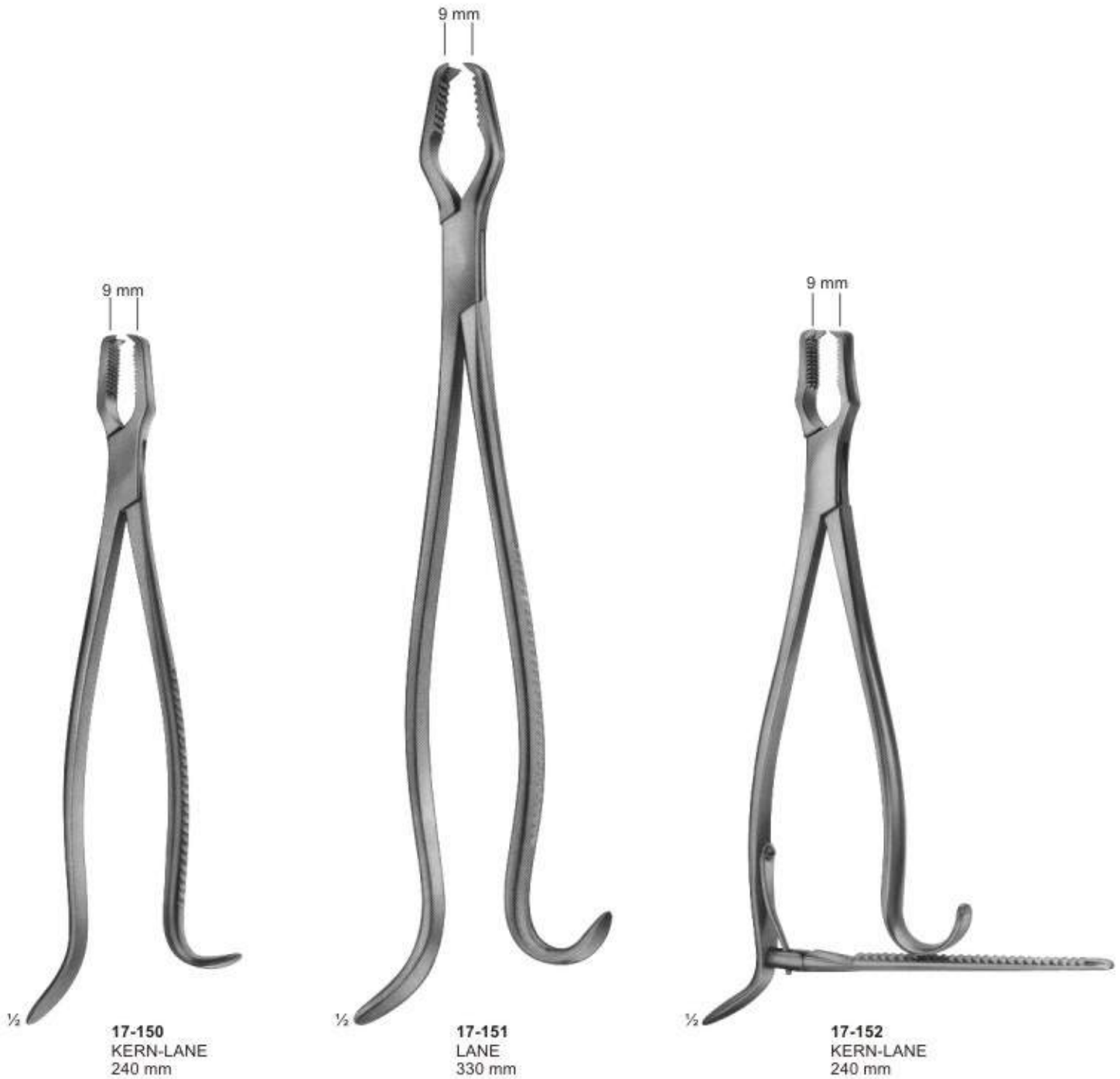

Bone Clamps Knochenhalteklammern



½

17-153 - 154
LOWMAN
17-153 170 mm
17-154 205 mm



½

17-155
LOWMAN-GERSTER
210 mm



½

17-156
LOWMAN-HOGLUND
175 mm

Bone Rongeurs Hohlmeißelzangen



17-157
LUER
150 mm



17-158
LUER
155 mm

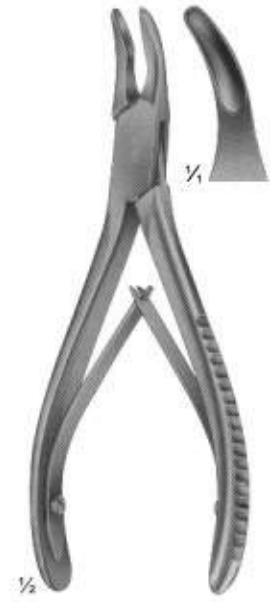

17-159
BLUMENTHAL
155 mm



17-160
BLUMENTHAL
150 mm



17-161 - 162
JANSEN
175 mm

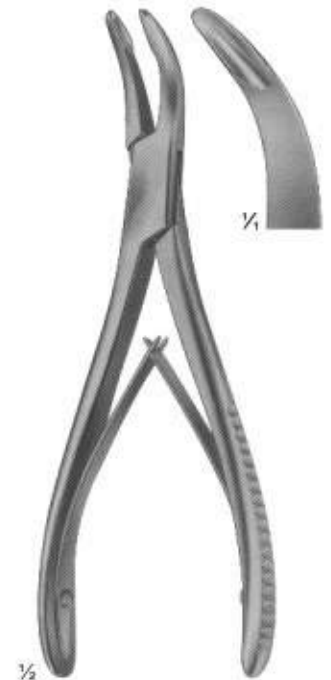

17-163
BANE-HARTMANN
175 mm

Bone Rongeurs Hohlmeißelzangen



17-164
STILLE
235 mm



17-165
LEKSELL-STILLE
240mm



17-166
STILLE-RUSKIN
240mm

**Bone Cutting Forceps
Knochensplitterzangen**

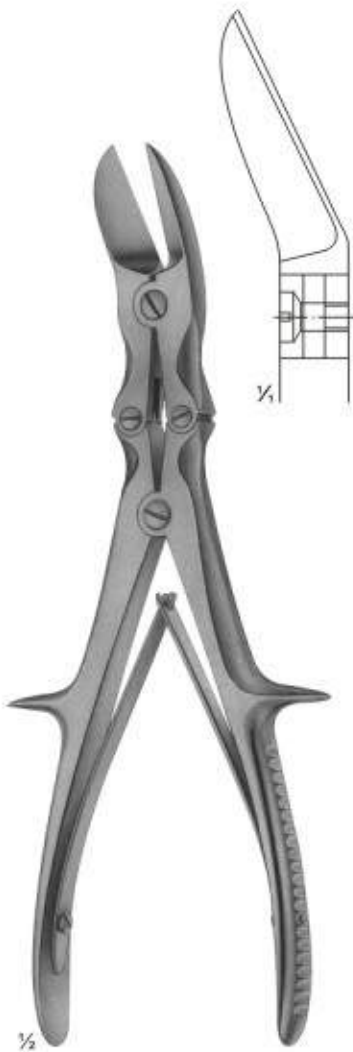

17-167
LISTON
curved on flat
240 mm

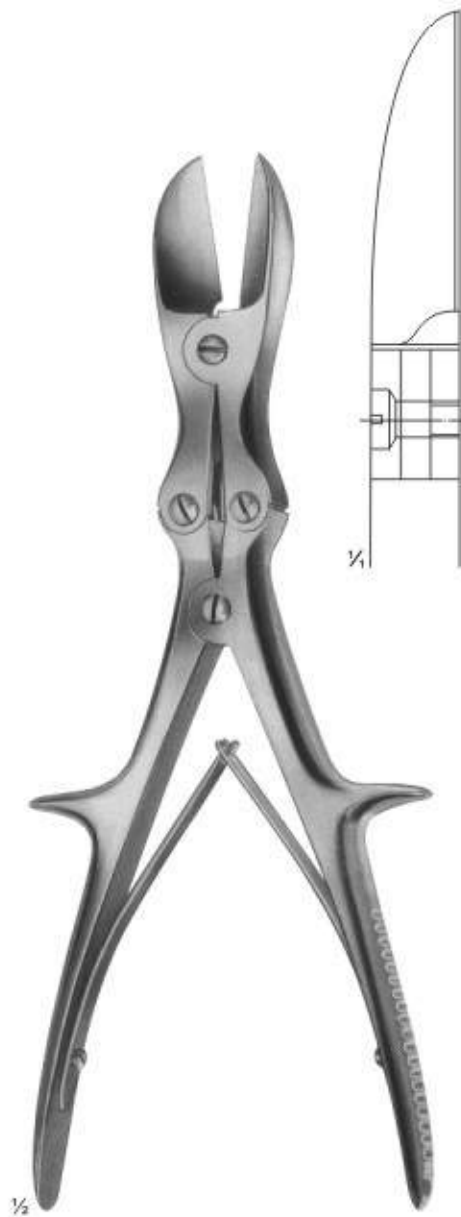

17-168
LISTON
straight
280 mm

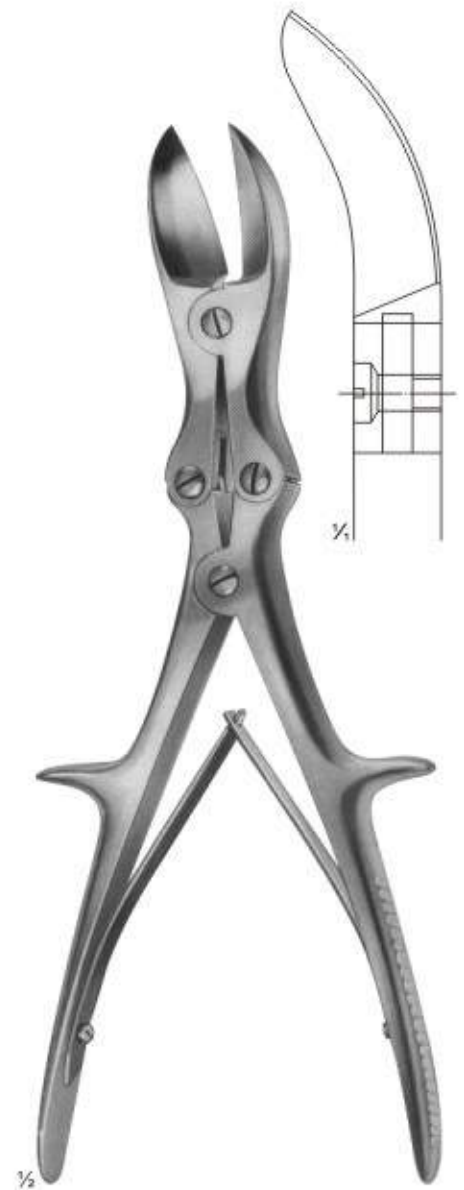

17-169
LISTON
curved on flat
280 mm

Plaster Shears Gipsscheren



17-170
STILLE-AESCULAP
260 mm



17-171
STILLE-AESCULAP
360 mm

Plaster Spreader, Plaster Breakers Gipsspreizer, Gipsabreißzangen



17-172
HENING
270 mm



17-173
MOD.USA
230 mm



17-174
290 mm



with removable jaws



17-175 - 176
WOLFF
17-175 180 mm
17-176 240 mm
plaster breakers

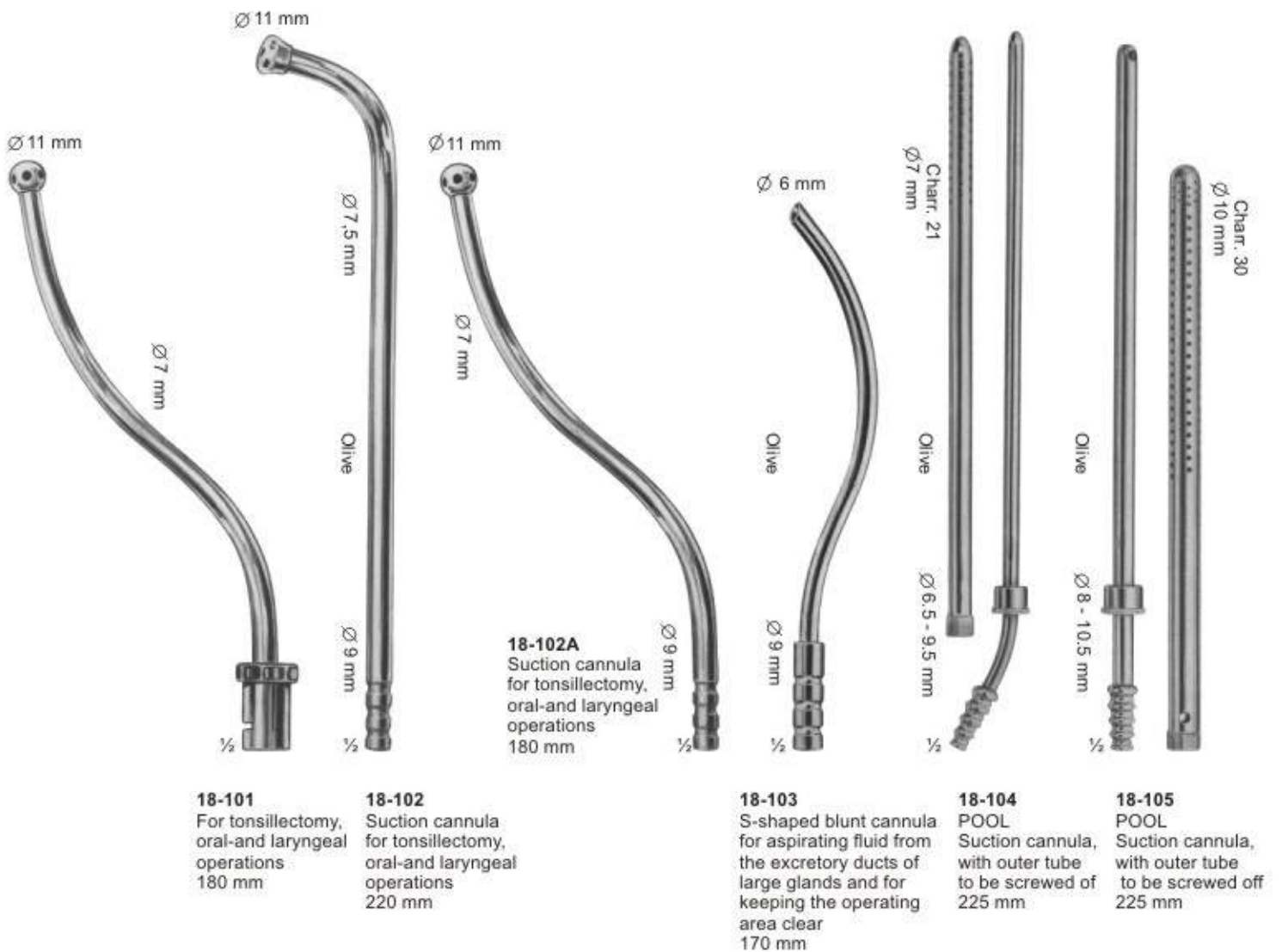

Suction Instruments Sauginstrumente



18-106 - 109
PLESTER
with finger cut-off and stylet, thumb piece parallel to curve, with LUER hub
195 mm

18-110 - 114
FERGUSON
with finger cut-off and stylet, thumb piece 90° to curve, with LUER hub
180 mm

18-115 \varnothing 4,0 mm
FERGUSON
with finger cut-off and stylet, thumb piece 90° to curve, with LUER hub
180 mm

18-116 \varnothing 3,0 mm
18-117 \varnothing 5,0 mm
FRAZIER
insulated, with finger cut-off and stylet, thumb piece 90° to curve, with LUER hub
180 mm

18-118
5,0 mm diam., Tip 6,5 mm wide, Nasal suction tube, with LUER hub
180 mm

18-119 \varnothing 4,5 mm
18-120 \varnothing 5,5 mm
Nasal suction tubes
175 mm

18-121
GORNEY
Suction dissector
180 mm

18-122 4 mm wide
18-123 5 mm wide
Suction raspatories, sharp, bayonet-shaped, with stylet
200 mm

18-124
LOPEZ-REINKE
Tonsil dissector with suction device
235 mm



19-101 - 115
Schimmelbusch

	Ø x H sizes in mm
19-101	80 x 80
19-102	120 x 120
19-103	140 x 140
19-104	160 x 120
19-105	160 x 150
19-106	190 x 150
19-107	190 x 190
19-108	240 x 160
19-109	240 x 240
19-110	290 x 160
19-111	290 x 240
19-112	340 x 160
19-113	340 x 240
19-114	390 x 190
19-115	390 x 290



19-116
Box
(without Bulldog clamps,
without silicone tape)



19-117
Box with support
120 x 65 x 13 mm
(ohne Bulldogklemmen)



19-118
Box with support for
needle electrodes,
without instruments

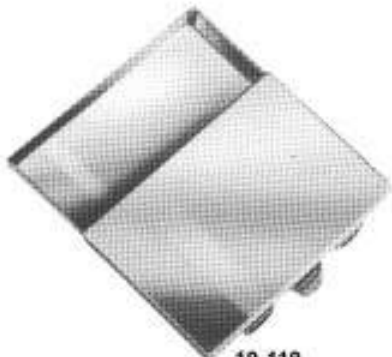

19-119
50 x 25 x 4,5 mm
19-120
65 x 42 x 8 mm
19-121
75 x 25 x 4,5 mm



19-122
Ø 65 mm x 15 mm



19-123-131

	Ø x H
19-123	30 x 90 mm
19-124	50 x 100 mm
19-125	50 x 130 mm
19-126	50 x 175 mm
19-127	50 x 100 mm
19-128	75 x 130 mm
19-129	75 x 175 mm
19-130	100 x 175 mm
19-131	100 x 200 mm



19-132-139

19-132	165 x 85 x 35 mm
19-133	200 x 100 x 35 mm
19-134	200 x 100 x 50 mm
19-135	230 x 130 x 50 mm
19-136	260 x 150 x 50 mm
19-137	270 x 235 x 50 mm
19-138	300 x 200 x 50 mm
19-139	235 x 275 x 50 mm



19-140
205 x 105 x 35 mm



19-141-142

- 19-141** Martin Sterilizing Forceps
consisting of:
1 Sterilizing Forceps, curved, 25 cm,
without ratchet, with lid for jar
1 jar with bottom plate (anti-tilt)
- 19-142** ditto, with 32 cm long Sterilizing Forceps

Round Metal Boxes and Medicine Cups



19-143-148

	Ø x H
19-143	75 x 60 mm
19-144	75 x 75 mm
19-145	100 x 60 mm
19-146	100 x 100 mm
19-146A	125 x 80 mm
19-147	125 x 125 mm
19-148	150 x 150 mm



19-149
25 cc

19-150
50 cc



19-151
20 cc
Medicine Spoon



19-152
Ø 75 x 12 mm
Tablet Tray



19-153
Ø 90 x 90 mm
Metal Cup



19-154
Ø 75 x 80 mm
Sputum Cup



Kidney Dish



19-155 - 157

19-155	170 x 100 x 35 mm
19-156	250 x 140 x 40 mm
19-157	275 x 150 x 45 mm



19-158 - 165

	Ø x H	
19-158	40 x 19 mm	0.05L
19-159	61 x 30 mm	0.07L
19-160	80 x 40 mm	0.14L
19-161	116 x 50 mm	0.35L
19-162	128 x 55 mm	0.45L
19-163	147 x 65 mm	0.70L
19-164	167 x 75 mm	1.10L
19-165	187 x 85 mm	1.60L



19-166 - 170

19-166	116 x 35 mm	0.30L
19-167	128 x 38 mm	0.40L
19-168	147 x 40 mm	0.50L
19-169	157 x 45 mm	0.75L
19-170	187 x 45 mm	1.00L



19-171
Ø 100 x 28 mm 0.15L



19-172
100 cc 0.1L



19-173 - 176

19-173	0,25L
19-174	0,50L
19-175	1,00L
19-176	2,00L



26-186
235 x 190 x 40 mm



26-187
Ø 220 x 70 mm



19-179
∅ 50 x 100 mm
Powder Pot



19-180
∅ 50 x 75 mm
Methot With Lid



19-181
∅ 50 x 75 mm
Methot Without Lid



19-182



19-183



19-184



19-185-186

19-185 ∅ 235 mm
19-186 ∅ 310 mm

Needle Cases



19-187
Sauerbruch
210 x 125 x 17 mm



19-188
Sauerbruch
210 x 125 x 17 mm



19-189
150 x 95 x 13 mm



19-190
150 x 95 x 13 mm



19-191
150 x 95 x 13 mm



19-192
150 x 95 x 13 mm



19-193
150 x 95 x 13 mm



19-194
150 x 95 x 13 mm



19-195
150 x 95 x 13 mm

Storing Cases



19-196
Deponette
245 x 135 x 35mm



19-197
Deponette
245 x 135 x 50mm



19-198
Deponette
245 x 135 x 60mm

Storing Cases

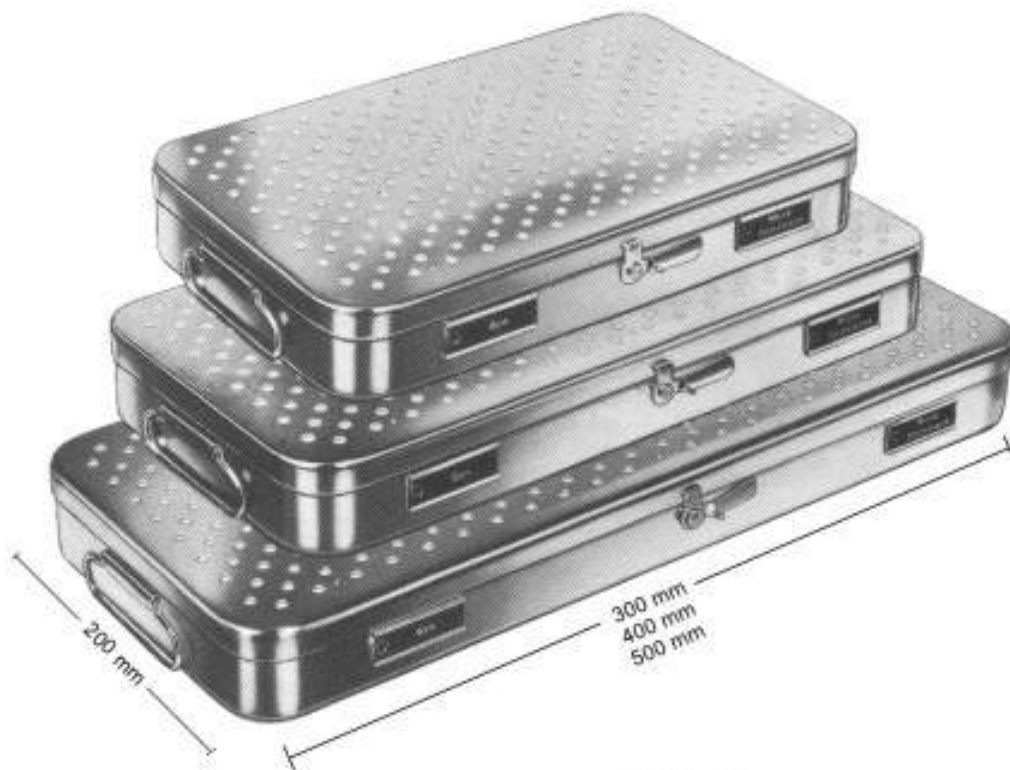

19-199 - 209

19-199	230 x 130 x 50 mm
19-200	260 x 150 x 50 mm
19-201	275 x 235 x 50 mm
19-202	300 x 200 x 50 mm
19-203	325 x 275 x 50 mm
19-204	420 x 175 x 50 mm
19-205	230 x 130 x 75 mm
19-206	260 x 150 x 75 mm
19-207	300 x 200 x 75 mm
19-208	325 x 275 x 75 mm
19-209	420 x 175 x 75 mm

Sterilizing Baskets / Trays



19-210 - 212

- 19-210 480 x 250 x 50 mm
- 19-211 520 x 250 x 75 mm
- 19-212 520 x 250 x 100 mm



19-213 - 218

- 19-213 240 x 240 x 50 mm
- 19-214 240 x 240 x 80 mm
- 19-215 240 x 240 x 100 mm
- 19-216 480 x 260 x 50 mm
- 19-217 520 x 260 x 80 mm
- 19-218 520 x 260 x 100 mm

Sterilizing Basket

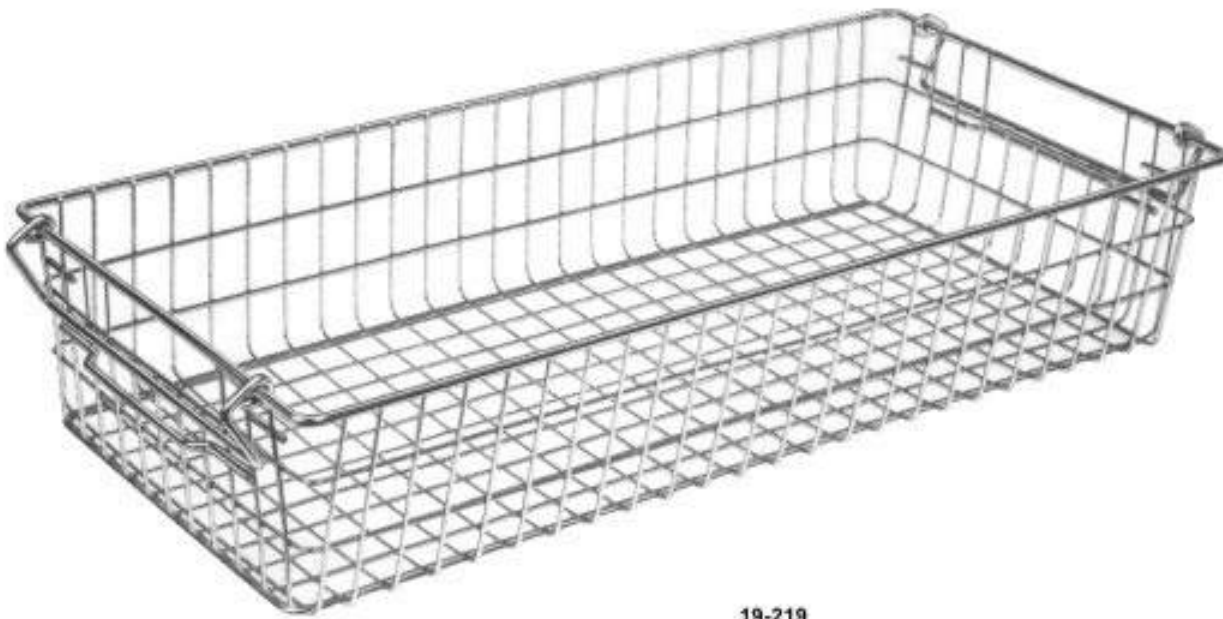

19-219
(60 x 30 x 15 cm)
Nominal dimensions

Scissors with Tungsten Carbide Inserts

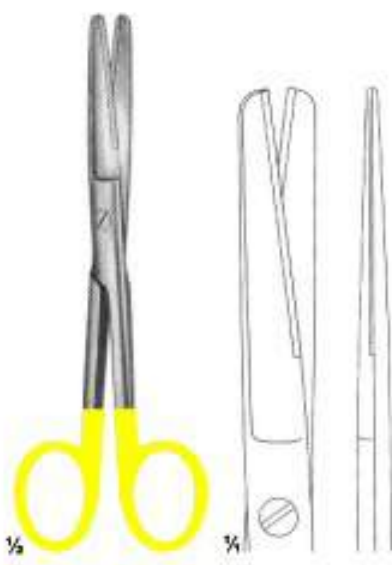

26-101
Standard

14,5cm
16,5cm
18,5cm



26-102
Standard

14,5cm
16,5cm
18,5cm



26-103
Standard

14,5cm
16,5cm
18,5cm



26-104
Standard

14,5cm
16,5cm
18,5cm



26-105
Standard

14,5cm
16,5cm
18,5cm



26-106
Standard

14,5cm
16,5cm
18,5cm

Scissors with Tungsten Carbide Inserts

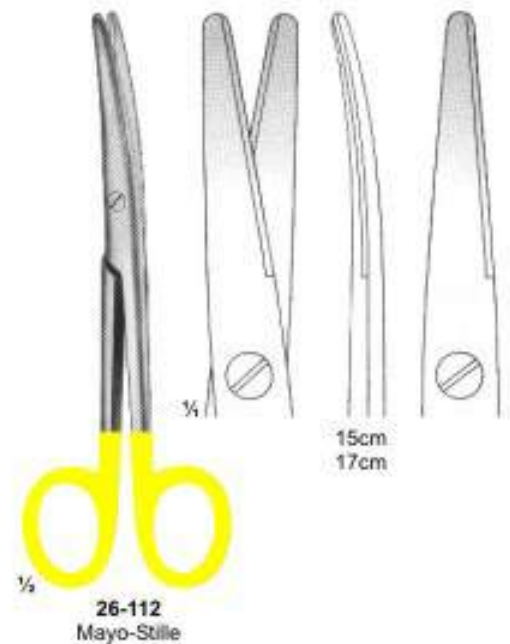
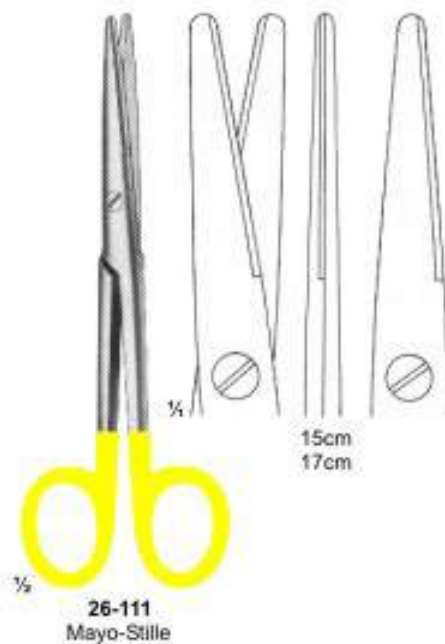
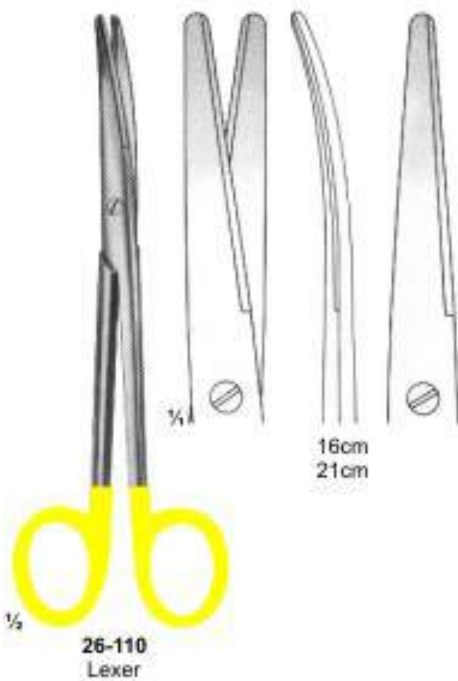
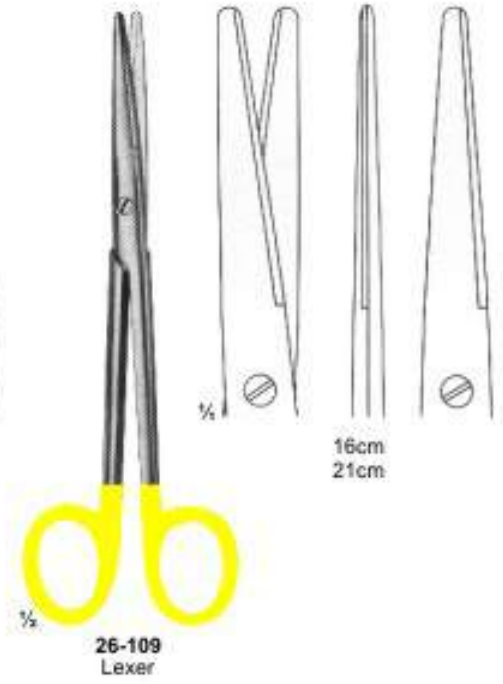
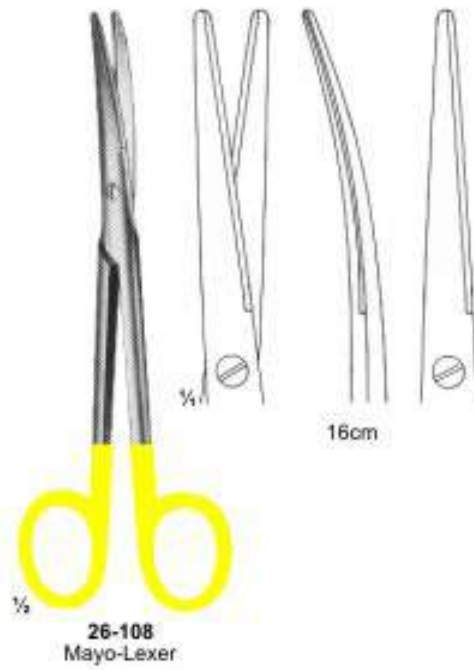
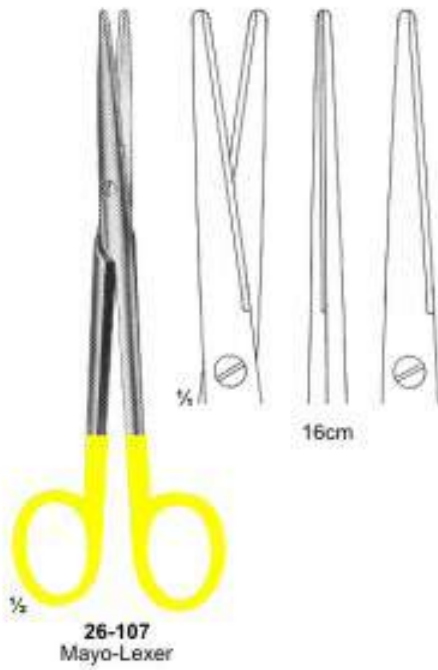

Scissors with Tungsten Carbide Inserts



Scissors with Tungsten Carbide Inserts

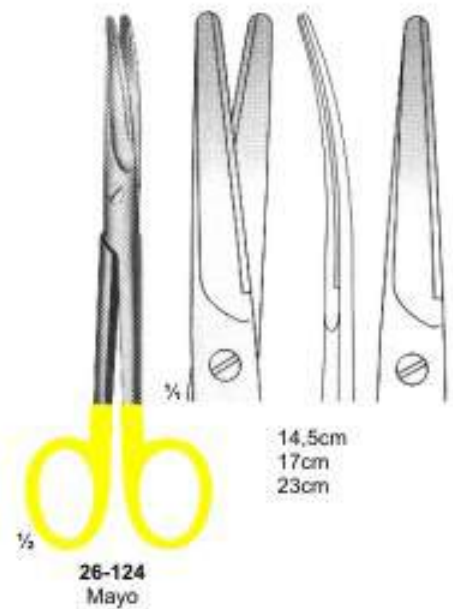
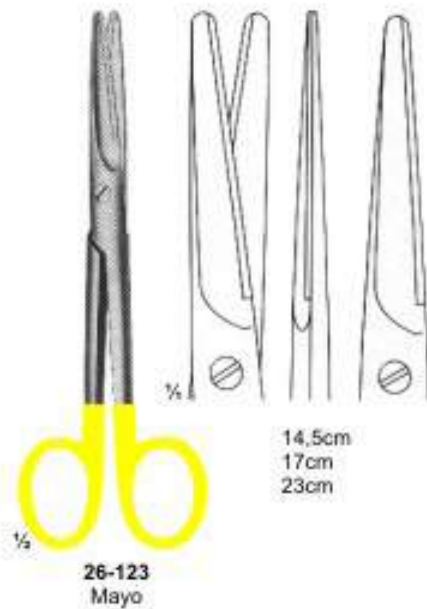
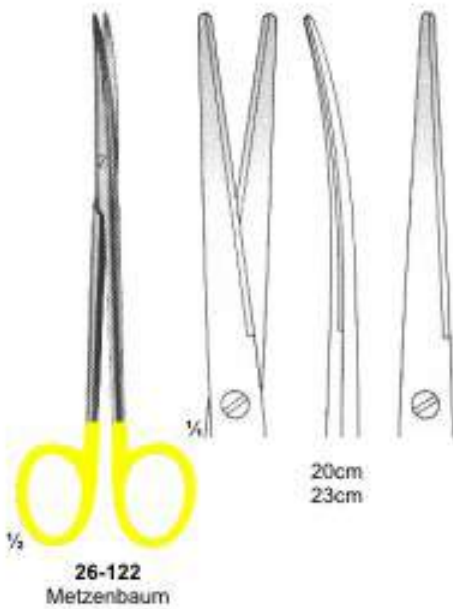
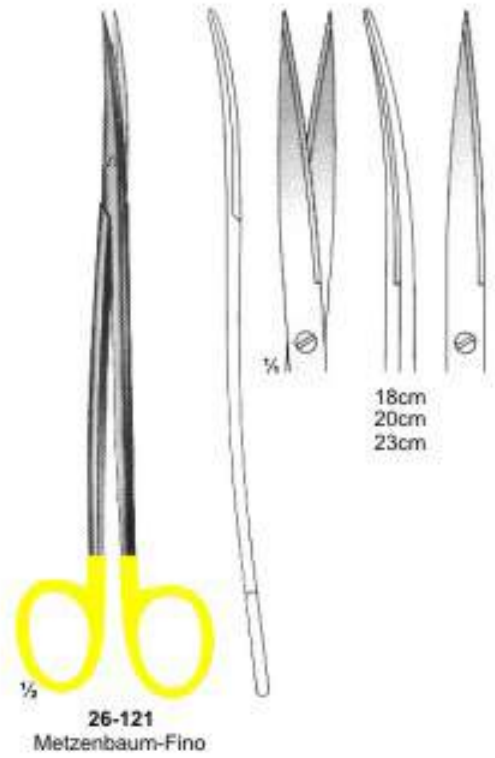
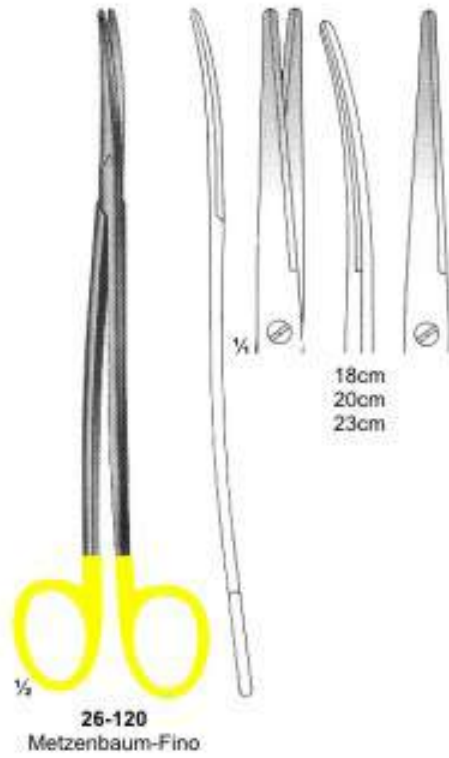
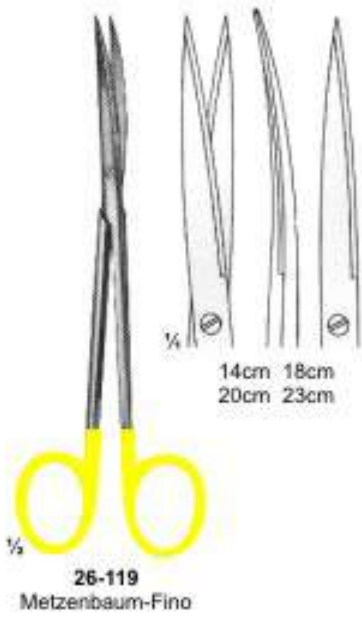

Scissors with Tungsten Carbide Inserts

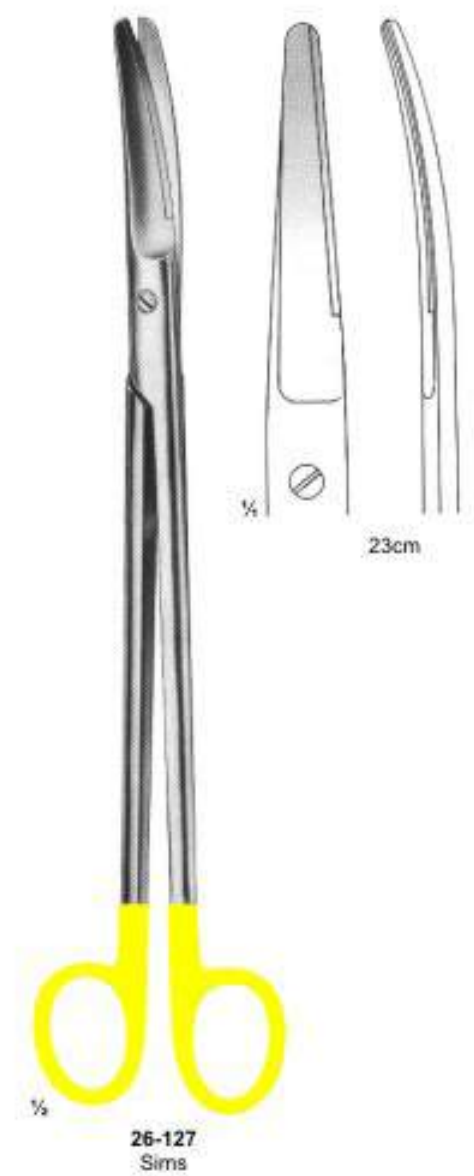
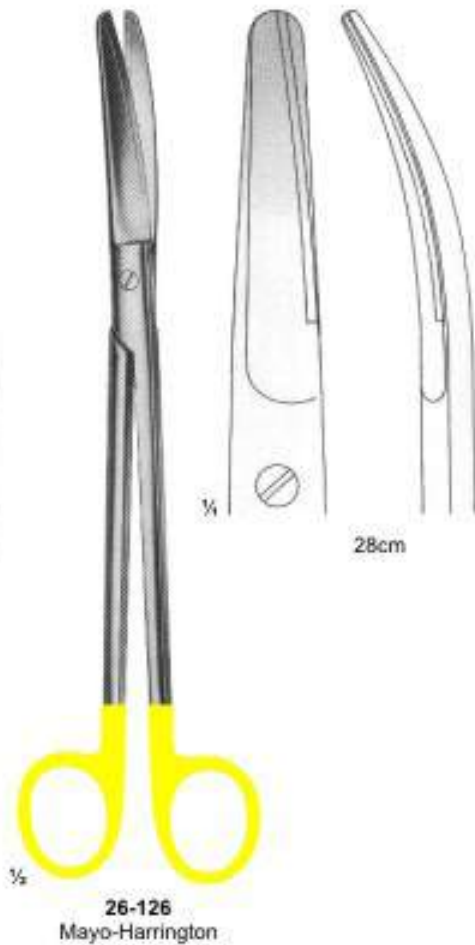
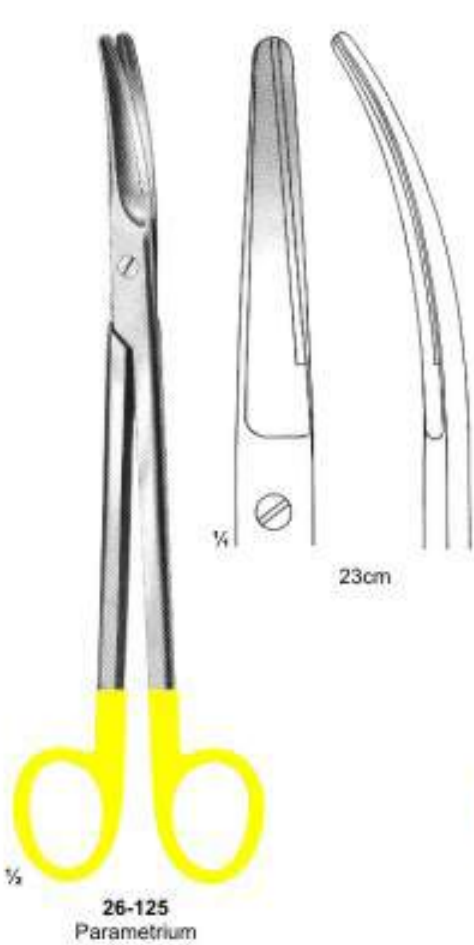

Scissors with Tungsten Carbide Inserts

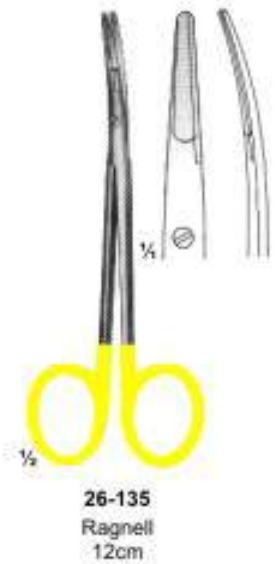
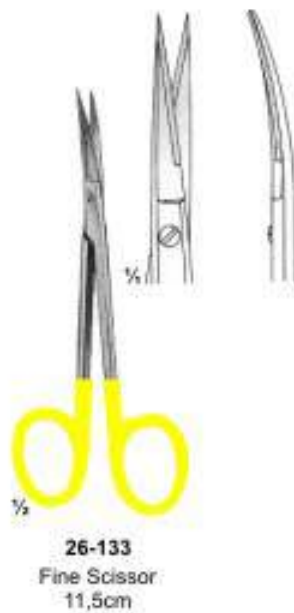
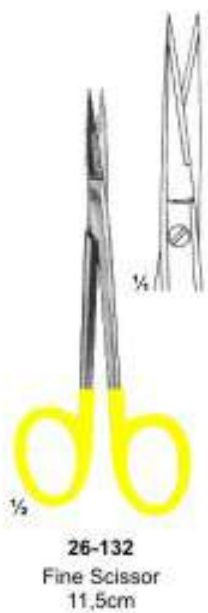
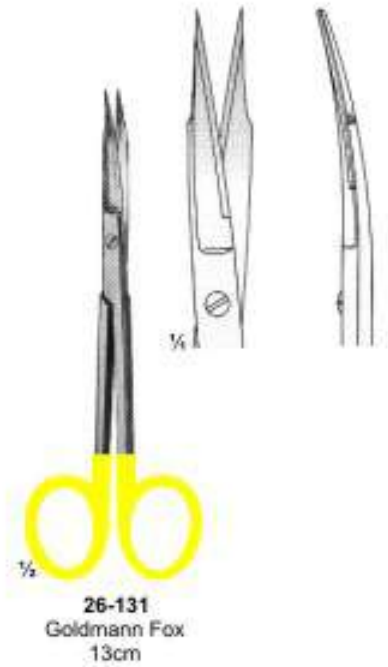

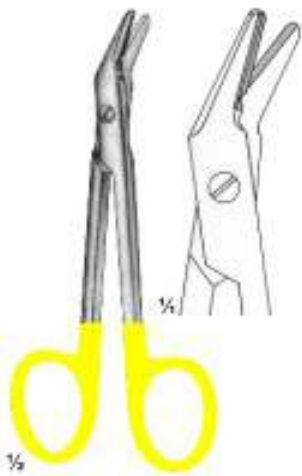

26-136
Universal
12cm



26-137
Ligature Scissors
1 Black & 1 Goldplated ring

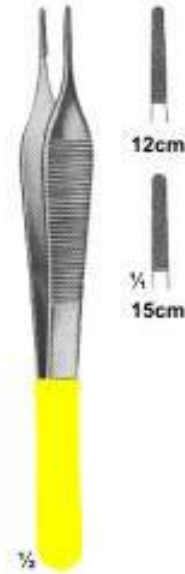

26-138
Adson



26-139
Cushing
17.5cm



26-140
Cushing
18cm



26-141
Cushing-Taylor
18cm



26-142
Dissecting Forceps
15cm



26-143
Semken
15cm

Dissecting Forceps and Needle holders with Tungsten Carbide Inserts



26-144
Wangensteen

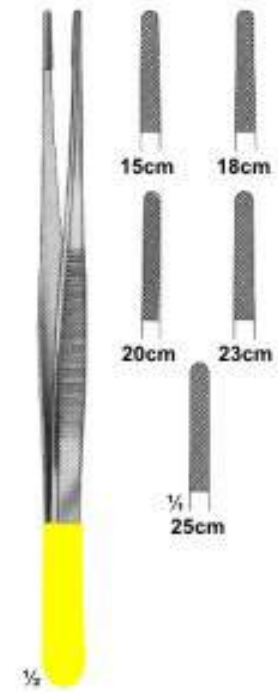

26-145
Potts-Smith

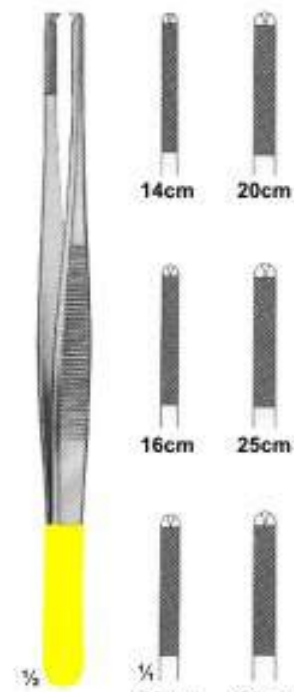

26-146
Oehler



26-147
Potts-Smith
22cm



26-148
Hepp-Scheidle
18cm



26-149
Castroviejo
14cm



26-150
Castroviejo
14cm



26-151
Arruga
16cm



26-152
Arruga
16cm



26-153
Castroviejo
13cm



26-154
Hegar
20cm 24cm

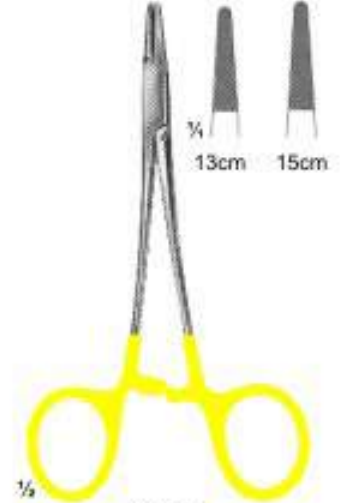

26-155
Halsey
13cm 15cm



26-156
Mayo-Hegar
16cm 18cm 20cm
24cm 26cm 30cm

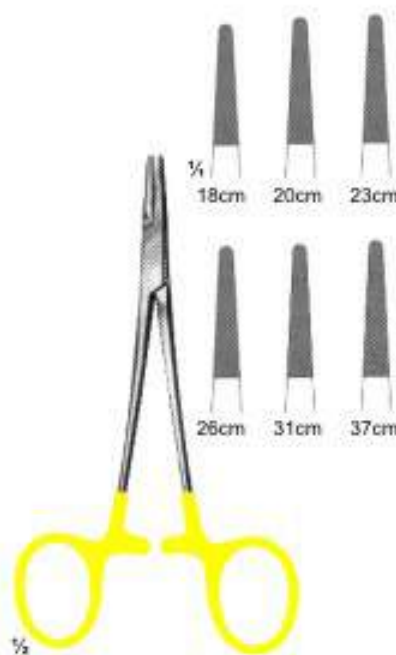

26-157
De-Bakey
18cm 20cm 23cm
26cm 31cm 37cm



26-158
Hegar-Vascular
14cm 18cm
20cm 23cm

Needle holders with Tungsten Carbide Inserts

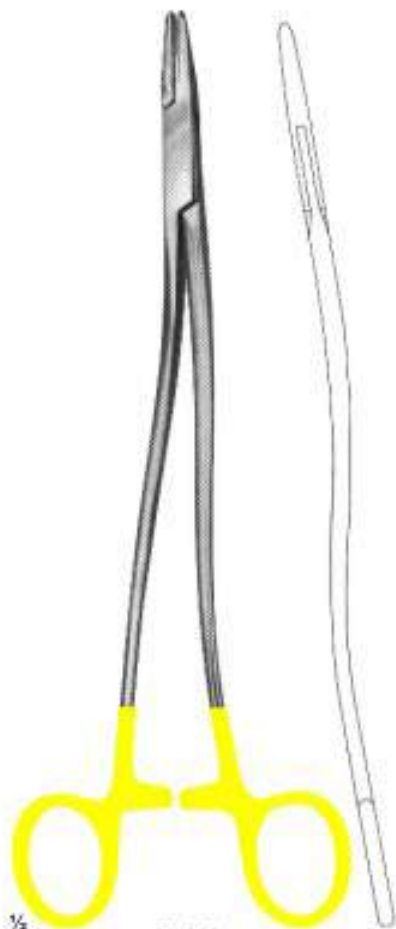

1/4
26-159
Bozemann-Wertheim
20cm 24cm 26cm



1/4
26-160
Straffe
22cm 23cm



1/4
26-161
Ryder
13cm 15cm 18cm
20cm 23cm 26cm



1/4
26-162
Ryder-Vascular
13cm 15cm 18cm
20cm 23cm 26cm



1/4
26-163
Martin
15cm 17cm 20cm



1/4
26-164
Sarot
18cm 20cm 26cm



Needle holders with Tungsten Carbide Inserts



1/2
26-172
Mathieu-Ryder
17cm
20cm 24cm



1/2
26-173
Lichtenberg
20cm



1/2
26-174
Langhals
20cm 25cm



1/2
26-175
Lichtenberg
20cm 25cm



1/2
26-176
Luehty-Beck
20cm 25cm



1/2
26-177
Luehty-Beck
20cm 25cm



1/2
26-178
Langebeck
18cm
20cm 23cm

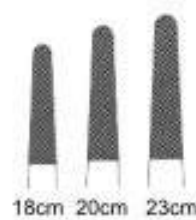

1/2
26-179
Langebeck-beck
18cm
20cm 23cm

VIVA

INSTRUMENTS

At Viva Instruments, you won't only find what you need; you'll get the best quality surgical, podiatry hair & beauty instruments at a fair price.

With years of experience in the industry, we have the expertise to thoroughly and efficiently serve our customers to ensure they're never disappointed. Whether you're a one-time buyer or looking to buy in bulk, you can count on us to provide great products and excellent service, every step of the way. Browse our inventory products catalogue and get in touch if you can't find what you're looking for.

Ihsan ul haq

UK Office

VIVA INSTRUMENTS

Unit 9 Liberty Centre, Mount Pleasant,

Wembley, HA01TX

London, UK

Tel: +44 020 34880546

email: info@vivainstruments.co.uk

www.vivainstruments.co.uk

Mon - Fri, 8am - 6pm

Saturday, 10am - 6pm

Sunday, Closed

Factory

VIVA INSTRUMENTS

Muhallah Chah Tarkhana

Nargit street

Sialkot

Pakistan

Tel: +92 524 598813

email: info@vivainstruments.co.uk

www.vivainstruments.co.uk

Mon - Fri, 8am - 6pm

Saturday, 10am - 6pm

Sunday, Closed