



旬  
SHUN

Shun  
Cutlery  
2021

# Contents

NEW!



12 Engetsu

NEW!



14 Narukami

NEW!



18 Premier Grey



22 Dual Core



26 Premier



32 Classic Blonde



36 Classic



44 Kanso



48 Sora

- 2 New Products
- 4 Blade Shapes
- 6 Premium Materials
- 10 Shun Anatomy
- 11 Common Terms
- 52 Shun Exclusives
- 53 Kai Housewares Products
- 54 Block Sets
- 58 Specialty Sets
- 60 Hinoki Cutting Boards
- 61 Steak Knives
- 62 Accessories
- 66 Quality Control
- 67 Use & Care
- 68 Honing & Sharpening
- 70 Warranty & Free Sharpening
- 72 Series Comparison

# Handcrafted tradition

In Japan, the blade is more than a tool; it's a tradition. From legendary samurai swords to the handcrafted culinary cutlery of today, the exquisite craftsmanship of Japanese blades is admired worldwide.

Since the 13th century, Seki City has been the heart of the Japanese cutlery industry. For more than 112 years, it has also been the home of Kai Corporation, the makers of Shun fine cutlery. Inspired by the traditions of ancient Japan, today's highly skilled Shun artisans produce blades of unparalleled quality and beauty. Shun is dedicated to maintaining this ancient tradition by continuing to handcraft each knife in our Seki City facilities. Each piece of this fine kitchen cutlery takes at least 100 individual steps to complete.

While we maintain these ancient traditions of handcrafted quality, we also take advantage of thoroughly modern, premium materials and state-of-the-art technology to provide Shun quality to millions of professional chefs and avid home cooks throughout the world.

Our brand name comes from the Japanese culinary tradition of "shun." Shun is a time—the exact moment when a fruit is perfectly ripe, a vegetable is at its best, or meat is at its most flavorful. Home cooks and professional chefs alike celebrate shun in their kitchens, awaiting each season's bounty and serving every ingredient in its proper time. The Shun name honors this tradition of seasonal, mindful eating and is a mark of our dedication to making kitchen cutlery that is always at the peak of its perfection, too.



# New products for 2021



## Engetsu Series

Shun's Limited Edition Engetsu series is visually stunning and utterly unique. The 71-micro layer Dual Core blade features our Zone Performance Blade Technology. The blade's beautiful layering pattern means that the cutting properties at the heel and tip are different from those at the blade center, providing different zones of performance where required.



## Narukami Series

The ultimate performance of a carbon steel cutting core meets the beauty and benefits of san mai stainless steel cladding in Shun's new Narukami series. This striking series is designed for professionals and for those who appreciate the unique qualities of fine carbon steel cutlery.



## Classic Blonde Steak 5"

This new Shun Blonde steak knife is the beautiful, fine-edged knife your best steaks deserve.



## Classic Blonde Santoku 5.5"

This multipurpose santoku proudly joins the Shun Blonde lineup in 2021 and features the 5.5-inch blade that many cooks prefer.

## Classic Blonde Chef's 6"

Versatile, lightweight, and easy to use, the new Shun Blonde 6-inch Chef's Knife is sure to be a kitchen favorite.

## Master Utility 6.5"

This new multi-function knife combines the agility of a utility with the do-it-all capabilities of a chef's knife.



## Premier Grey Series

Shun Premier gets a sophisticated new look in the eye-catching Premier Grey series. Cool, grey Pakkawood handles are set off by Premier's mirror-polished blade and hammered tsuchime finish. Lightweight, highly maneuverable, and hand sharpened to a razor edge, this new series offers all the performance of Shun Premier, now in gorgeous grey.



## 15-Slot In-Drawer Knife Tray

Keep countertops clear when you store your Shun collection in a convenient kitchen drawer. This beautiful tray holds 14 knives and even has a slot for a honing steel to help maintain your knives. Dimensions: 10" x 17.5" x 2.5"



## Combination Whetstones & Leveling Stone

Shun introduces four whetstones to keep your Shuns performing at their Shun-sharp best. Then, to keep your whetstones at their best, our new leveling stone easily returns your whetstones to their perfectly flat condition, ready to sharpen again.

# The must-have basics



## Paring

A paring knife gets its name from its main function: removing or "paring" away things, such as peels, from fruits and vegetables.



## Utility

In size, it's between a chef's knife and a paring knife, making it the perfect size for all those in-between tasks.



## Chef's

If there is one knife that no cook can be without, it's a chef's knife. This all-purpose blade is ideal for a wide variety of cutting tasks.

## Want to expand your collection?

The right knife makes meal preparation faster, easier, and more satisfying. Are you a bread baker? You'll love a Shun bread knife. Prefer a smaller knife? Try a 6-inch chef's knife. This section gives you a quick look at some other blade shapes designed to make cooking even better.



## Bread knife

Shun bread knives feature razor-sharp, wide, "low frequency" serrations. The serrations let you gently cut through the bread without crushing and with fewer crumbs.



## Slicing knife

A slicing knife is long and narrow, enabling you to make even slices without sawing. This kind of clean cut keeps more of the flavorful juices inside the meat.



## Flexible Fillet

Just the right amount of flex in this blade's AUS8A steel makes filleting fish easier.



## Steak knife

A razor-sharp, fine-edged knife glides through your steak, cutting fewer of the capillaries in the meat and keeping more of the juices inside.



## 6-inch Chef's knife

Sometimes you want a chef's knife that's particularly lightweight and highly maneuverable. A 6-inch chef's knife is a perfect choice.



## Santoku

A knife of many talents, a santoku easily handles all the basic cutting tasks. Slightly shorter than the standard chef's knife, the santoku is light, agile, and very easy to maneuver.

# Specialty blade shapes

## Master Utility

The Master Utility combines the nimbleness of a utility knife with the multifunction capabilities of a chef's knife. Accomplish a full range of kitchen tasks with a single, extremely useful knife.

## Asian Multi-Prep

In Japan, this nimble, triangular blade is called a honesuki. The narrow tip is ideal for maneuvering around bones and between joints. The wider end makes slicing vegetables easy, too.

## Boning/Fillet

The narrow, sharp, curved blade gets in close, making it easy to separate meat from bone.

## Asian Utility

The Asian Utility Knife, developed by Shun, is adept at processing everything from vegetables for stir fry to thinly slicing meats. Every part of this knife can be put to use.

## Ultimate Utility

"Low-frequency" serrations make the knife perfect for slicing delicate thin-skinned fruits and vegetables. The wide blade and rounded tip also makes it a great knife for spreading condiments.

## Nakiri

With its straight blade, edge, and spine, the nakiri is used with a simple push cut; it is ideal for processing large quantities of vegetables.

## Kiritsuke

The kiritsuke is known as the Japanese master's knife. Similar to a chef's knife, it works extremely well with vegetables and slices proteins with grace and ease.

## Yanagiba

The yanagiba is most often used for slicing raw fish for sashimi and for slicing sushi rolls, and preparing a variety of proteins.

## Brisket knife

Ideal for trimming and slicing larger cuts of meat, including brisket, ham, and turkey. The brisket knife is long and narrow with hollow-grounds, enabling you to cut elegant slices in a single pass.



# Premium materials

Steel is an alloy of iron and carbon; the atoms of one element occupy the spaces between the atoms of the other so that the materials are inextricably joined. Most steel also has ingredients to enhance specific characteristics. For example, stainless steels contain chromium to enhance stain resistance.

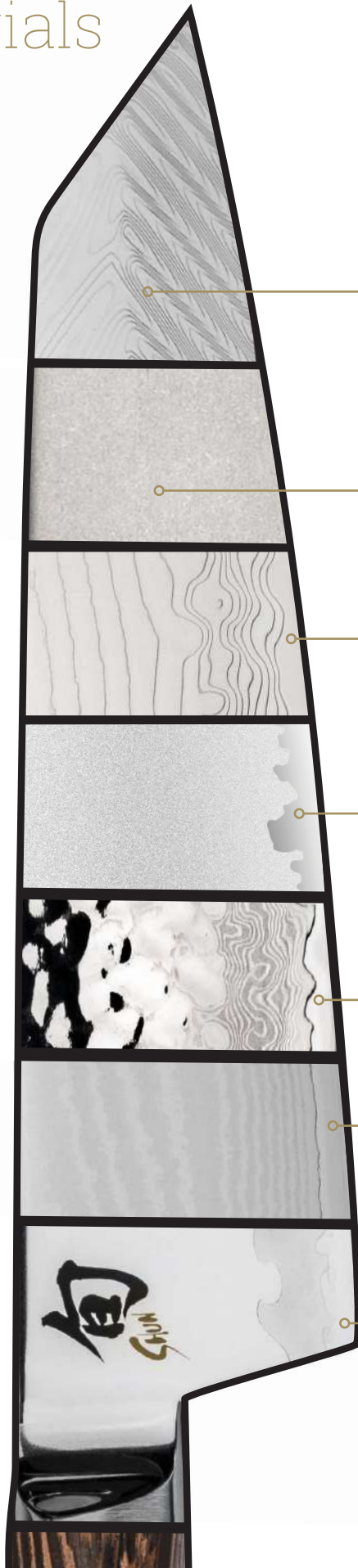

## Dual Core

71 alternating micro-layers of high-carbon, high-chromium VG10 & VG2 stainless steel extend all the way to the edge. Dual Core steel is used in Shun's Dual Core, Hikari, and Engetsu series. These two steels are layered, welded, and roll-forged together. VG2 is a fine grained, high-carbon, high-chromium Japanese stainless steel that takes and holds a very sharp edge.

## AUS10A

A Japanese high-carbon stainless steel with high strength, as well as good corrosion resistance, hardness, and wear resistance. AUS10A steel is used in Shun's Kanso series. Added vanadium refines the grain of the steel so that it takes a fine edge.

## SG2 STEEL

An advanced, high-chromium powdered steel alloy. SG2 steel is used in Shun's Fuji and Kaji series. The powdered steel manufacturing method enables steel grain structure to be very fine and dense.

## BLUE II CARBON STEEL

A highly sought-after Japanese cutlery steel. Blue II carbon steel is used in Shun's Narukami series. It is a simple carbon steel alloy that takes a fine edge and can be re-sharpened easily when needed. It has some additional alloying elements that enable it to provide superior edge retention and toughness.

## VG-MAX

The newest in the line of VG super steels and is proprietary to Shun. VG-MAX™ steel is used in Shun's Premier, Premier Grey, Premier Blonde, Classic, and Classic Blonde series. This steel builds on the highly successful VG10 formula by increasing ingredients that take this advanced steel to the "MAX." VG-MAX includes more carbon to improve strength and durability. It has additional chromium for wear and corrosion resistance. Increased tungsten enables the steel to be very fine-grained so the edge can be extremely sharp. Molybdenum improves corrosion resistance and strength. Vanadium improves impact resistance and enables the steel to form vanadium carbides, which enhance cutting performance.

## VG10

A complicated blend. In addition to iron and carbon, it contains chromium, manganese, molybdenum, silicon, and vanadium. Most of these elements improve desirable blade characteristics such as wear resistance, corrosion resistance, hardness, and toughness. Vanadium helps make sure the steel's texture is fine, which is important for Shun's extremely sharp, long-lasting edge. VG10 is used in Shun's Sora series.





Shun handles employ a variety of materials and designs, both traditional and contemporary, to ensure each Shun offers comfort and secure grip during use.

**Tagayasan**

In Japan, this unusual dark-grained wood is known as “iron sword wood” for its incredible durability. The wood’s hardness requires extra handcrafting during manufacturing, but will provide its owner with a lifetime of service. Tagayasan (or wenge) wood handles are used in Shun’s Fuji, and Kanso series.

**TPE**

TPE is a thermoplastic elastomer that is molded to provide absolute precision in handle geometry. Shun textures the material for an easy and secure grip, even in wet conditions. TPE handles are used in Shun’s Sora series.

**Micarta**

Micarta is a strong, durable laminate made from resins layered with a variety of different types of fabrics. Micarta can handle extremes of heat or cold, resists moisture, and is extremely stable. Ground and polished, it reveals attractive patterning. Micarta handles are used in Shun’s Narukami series.

**Pakkawood**

Most Shun handles are PakkaWood®, a premium handle material made of genuine hardwood impregnated with resin. The resin makes it moisture resistant, strong, and durable—important for kitchen knives. Sanding and buffing brings PakkaWood to a beautiful gloss finish. As with natural wood, no two pieces of PakkaWood are exactly alike. Pakkawood handles are used in Shun’s Dual Core, Hikari, Engetsu, Kaji, Premier, Premier Grey, Premier Blonde, Classic, and Classic Blonde series.



**Ebony**  
Classic,  
Dual Core,  
Kaji

**Blonde**  
Classic Blonde,  
Hikari, Premier  
Blonde

**Walnut**  
Premier

**Grey**  
Premier Grey

**Blue**  
Engetsu

**The many colors of Pakkawood**

Because of the way this premium handle material is made, it can be left in its natural color (Blonde) or dyed in a variety of rich colors.

# What is Layered Damascus?

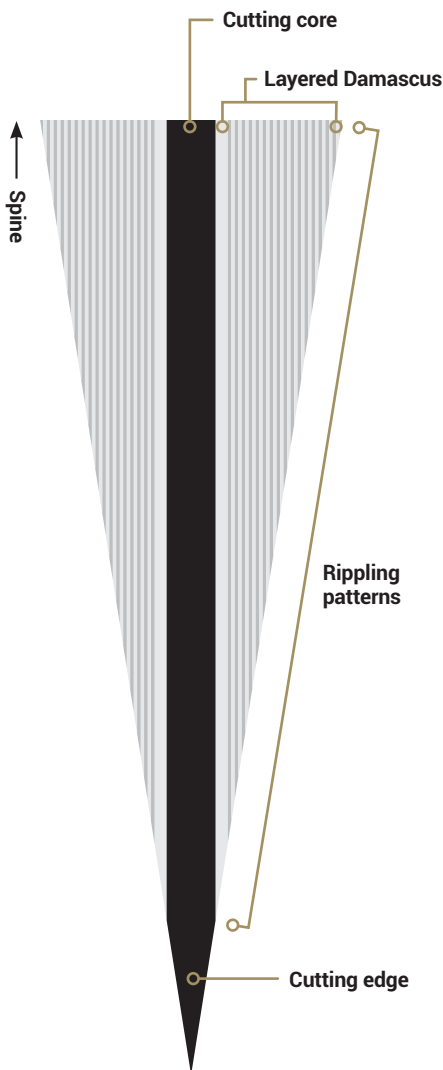
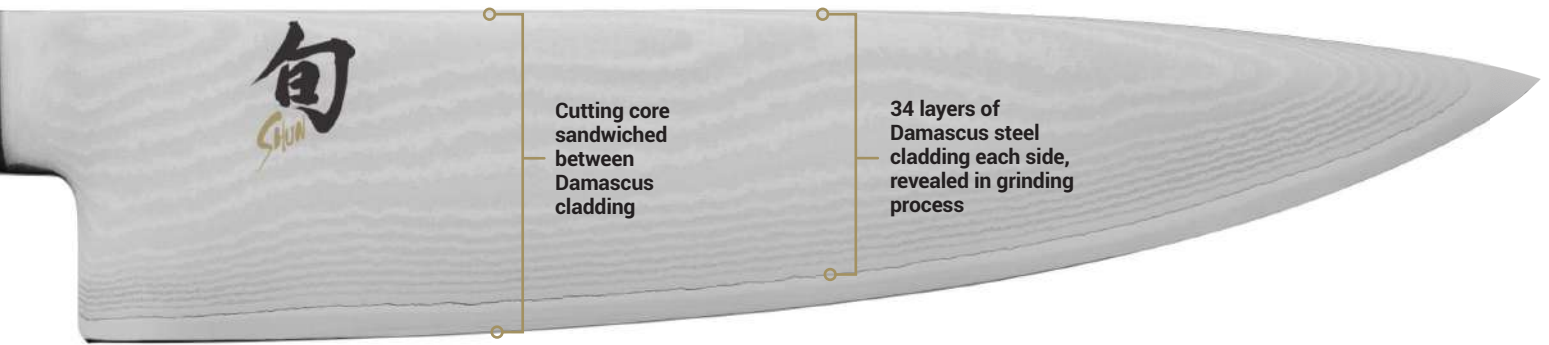

Shun's Damascus is formed by layering different types of metal alloys together, then forging them into a single piece. The process and the different characteristics of the layered metals create the rippling patterns you see on the blade. The number of layers can vary; many Shun knives, for example, have 34 layers of metal on each side of a high performance VG-MAX cutting core.

As Shun artisans grind each Damascus-clad blade from its thickest point at the spine to its razor-sharp cutting edge, they reveal the patterns. To bring them out even more, they bead blast or acid etch each blade. Bead blasting also provides surface textures to help food release from the blade and reduce

cutting drag. During acid etching, the layered metals react to the solution in different ways. For example, carbon steel darkens, while nickel silver remains bright. The alternating layers of darker and brighter metal help reveal the flowing, rippled pattern.

Damascus looks beautiful, supports and protects the hard, dense cutting core, and adds stain resistance. In Japan, this style of blademaking is known as *kasumi*. Kasumi means "mist" and is so called because the exterior Damascus can have a lovely misty appearance when compared to the harder cutting core. Kasumi construction provides the ultimate mix of properties: an extremely sharp edge and ease of sharpening.

## Shun layer counts

Engetsu: 71 layers of VG2 & VG10 stainless steel

Narukami: 2 layers of stainless steel + Blue II Carbon steel core

Dual Core: 71 layers of VG2 & VG10 stainless steel

Hikari: 71 layers of VG2 & VG10 stainless steel

Fuji: 160 layers of stainless steel + SG2 core

Kaji: 64 layers of stainless steel + SG2 core

Premier & Premier Grey: 68 layers of stainless steel + VG-MAX core

Classic & Classic Blonde: 68 layers of stainless steel + VG-MAX core

Kanso: Solid AUS10A

Sora: 2 layers of stainless steel + VG10 core



## What is Dual Core Steel?

The Shun Dual Core series features a Damascus blade made from two premium-quality, high-carbon stainless steels. 71 alternating micro layers of high carbon, high chromium VG10 and VG2 stainless steels are roll-forged to produce a finer grain in the steel and to give it both strength and beauty. The laminated steel is then hot forged to create the beautiful herringbone pattern that allows the layers to alternate along the cutting edge (see diagram on right).

During normal use, the two steels will wear at different rates creating micro serrations along the edge. This means Dual Core's extremely sharp edge performs at a high level even longer. The etched laminations in the blade reduce drag, helping food release from the blade so it glides through each cut quickly and easily. Dual Core blades are thin, light, strong, and offer you an extremely high level of performance as well as refined beauty.

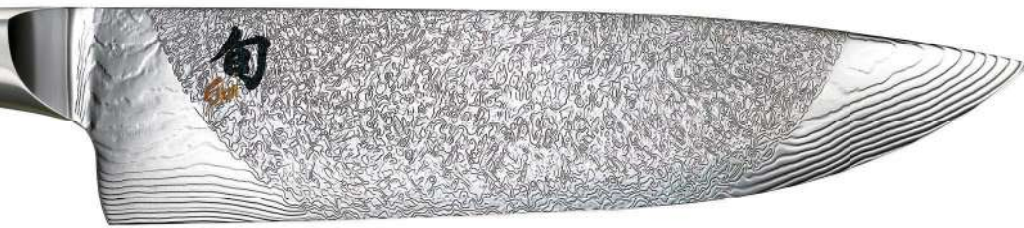
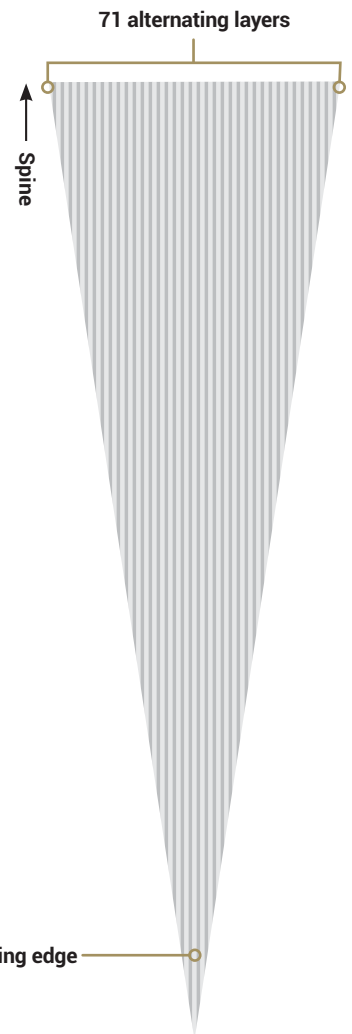

## What is Zone Performance Blade Technology?

Shun's visually stunning new Engetsu knives are made using Dual Core steel (see above)—but with a difference. While Engetsu's blade steel has the same 71 alternating micro layers of VG10 and VG2 stainless steel, the blade's unique layering pattern means that the heel and tip of the blade are different from the center. You can see the difference in the photograph above. This enables Engetsu to provide two different zones of performance: our Zone Performance Blade Technology.

At heel and tip, where the knife impacts the cutting board most strongly, the layering is less dense so that the heel and tip are tougher—and can handle those impacts. In the center of the blade, where most of the slicing happens, the layering is denser for smoother, speedier cutting. What's more, the heavy patterning in the center reduces blade drag, helping food release from the blade and making each cut an easy glide.

# What is Composite Blade Technology?

Shun's proprietary Composite Blade Technology is a technique that enables us to put high-performance steel exactly where it's needed most—on the cutting edge of the knife. In Shun's Sora line, VG10 san mai comprises the lower part of the blade, that is, the cutting edge.

The upper part, above the copper weld line, is 420J Japanese stainless steel. The two sections of the blade are laser cut and fit together like pieces of a jigsaw puzzle. Braze welding permanently joins the pieces to create a durable blade that puts the performance of VG10 exactly where it's needed.

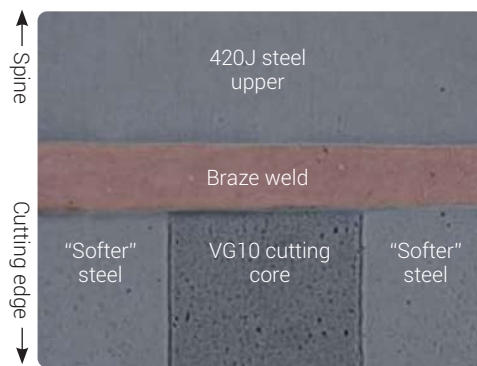

Microscopic cross-section of a Sora composite blade

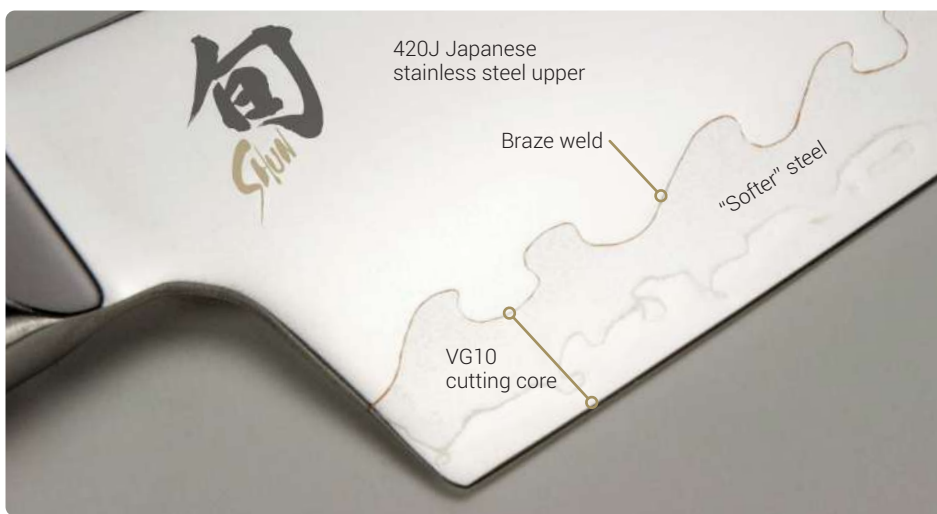
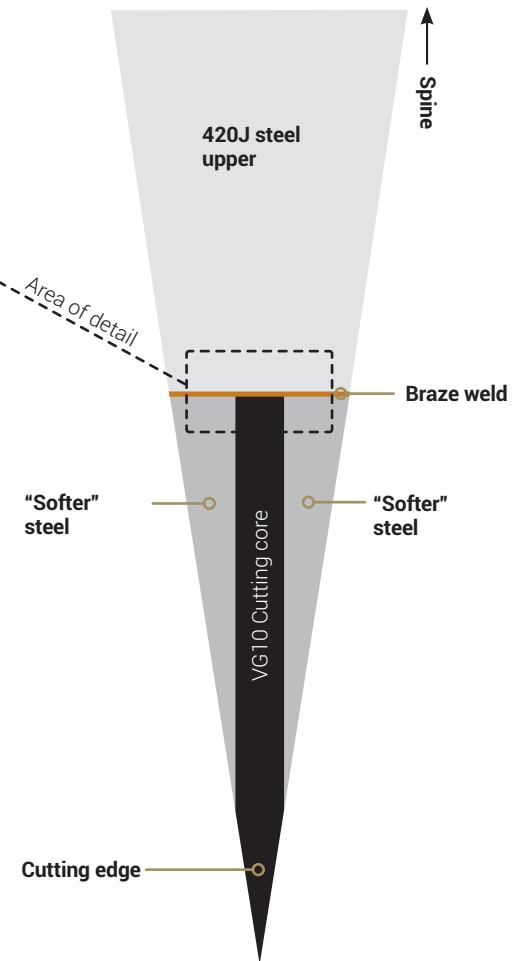

# Anatomy of a Shun

**Knife butt:** The very end of the knife. If a knife has an end cap, the cap is placed on the knife butt.

**Bolster:** Where the blade meets the handle; the bolster adds strength and balance. Many Shun bolsters are contoured to make it easy to use a chef's grip.

**Spine:** The top or back of the knife blade, opposite the cutting edge.



**End cap:** A metal cap on the end of a knife's handle; the cap adds beauty and balance to the knife.

**Heel:** The rear part of the blade, opposite the tip.

**Tip:** The pointed front part of the blade.

# Other common terms

Throughout this catalog we list the key features of the various Shun cutlery series. Here's an easy reference to provide you with quick definitions and a summary of benefits for those commonly used terms.

**Core steel:** The cutting edge of Shun knives, often sandwiched between Damascus layers.

**Stainless Damascus cladding:** Shun's Damascus cladding is formed by layering different metal alloys together, then forging them into a single piece. These micro layers of cladding support and protect the hard, dense cutting core, add stain resistance, and help food release from the blade.

**420J stainless steel:** A quality Japanese steel known for excellent stain resistance.

**AUS8A:** A Japanese high-carbon, low-chromium (for enhanced sharpenability) stainless steel that has proven to provide an excellent balance between toughness and strength, edge holding and corrosion resistance. Shun uses this steel in applications such as meat cleavers that require a tougher steel and the Classic Fillet for flexibility.

**Hammered tsuchime finish:** A traditional Japanese hammered blade finish. It gives the blade a rustic look and helps food release more easily from the blade.

**Exclusive Heritage finish:** Shun Kanso features this attractive finish that not only hides use scratches, but gives the series a rustic look that just improves with age.

**Mirror polish:** A knife finish that is so highly polished that it reflects like a mirror. A mirror polish is achieved by using very fine polishing media.

**Razor-sharp 16° cutting edge:** Hand sharpened to a 16° angle each side for top performance; blade is double-bevel, flat ground.

**Proprietary Composite Blade Technology:** Permanently joins Sora's san mai edge to the blade upper; brings together the best qualities of two steels in one blade.

**San mai:** A traditional, high-end Japanese blade-making technique in which a very hard steel blade core is clad with a single layer of "softer" steel on each side of the core for support and protection against corrosion.

**Zone Performance Blade Technology:** Engetsu's blades are made of 71 alternating layers of VG10 and VG2 stainless steel. The blade's unique layering pattern makes performance at the heel and tip different from the center. At heel/tip, the layering is less dense so that zone is tougher. In the center zone, layering is heavier for smoother, speedier cutting.

**Hamon:** In the making of traditional Japanese katanas, the cutting edge of the blade is often tempered differently than the spine. The hamon is a wavy line that separates the two types of tempering. While Shun knives do not have a traditional hamon, several series take inspiration from the graceful hamon line. Shun Sora features a modern "hamon" where the two steels that make up Sora's Composite Blade meet and are permanently joined (see Composite Blade Technology). Narukami features san mai (see above) construction. Where the carbon steel core is revealed, the cladding creates a wavy line inspired by the hamon.

**Push/pull serrations:** The serrations on the knife are angled so that the same amount of cutting power is applied during both the forward and backward strokes of the blade.

**Sharpening angle:** The ideal sharpening angle for any knife depends on its design, use, and type of steel. With Shun's advanced steels, we can hand-sharpen to a razor-sharp 16° angle on each side. This provides for easy, efficient cutting, yet also enables the edge to be less fragile and longer lasting.

**Heat treatment:** A process during which metal is heated and cooled to change its microstructure, bringing out its very best properties. With precise heat treatment, blade steel becomes finer grained, making it stronger and harder so blades can be thinner, sharper, and provide a longer-lasting edge.

**Full tang:** The tang is a narrowed extension of the blade that extends all the way to the end of the handle. It adds strength and balance to the knife.

**Full composite tang:** The tang is the part of the blade that is concealed inside the handle. In a full-tang knife, the tang is the same material as the blade and extends to the end of the handle. In a full composite tang, the tang also extends to the end of the handle but is a different steel than the blade steel. This helps lighten the weight of the knife for greater maneuverability while providing strength and balance.

**Hidden tang:** a style of knife construction in which the tang is fully concealed within the handle. Shun series such as Shun Classic feature a hidden tang.

**Rabbit tang:** The blade tang extends part way into the handle; this controls weight and enhances maneuverability and is how samurai swords were commonly made.

**Sub-hilt:** Enables Shun to adjust the handle to ensure precision balance of the knife.

**Traditional Octagonal handle:** Octagon-shaped handles provide a comfortable, secure grip.

**Traditional-style handle with emblem:** Provides excellent grip, easy maintenance; polished steel Shun emblem enhances and balances handle.

**Saya:** Japanese for "sheath." Fine Japanese knives may include a traditional wooden saya to protect the blade during storage. Universal Sayas are available for purchase separately. See page 64.

For more information on steel, handle materials, and other common knife terms, please see page 6.

# Engetsu

## Limited Edition

You can feel Engetsu's difference with each cut. Precision control at heel and tip. Butter-smooth slicing at center. This is our Zone Performance Blade Technology, revealed by the graceful, circular blade pattern. Engetsu, which means "full moon" in Japanese, is named for this unique, circular pattern. With its exquisite looks and enhanced cutting performance, the full moon rises. Beautifully.

### Precision-Balance Handle Technology

- Features Shun brushstroke end cap.
- The sub-hilt adds weight and balance.
- A forged bolster and end cap enable precision handle balancing.

### Zone Performance Blade Technology

- Engetsu's Dual Core blade steel is made of 71 alternating layers of VG10 and VG2 stainless steels. Because of the blade's unique layering pattern, the properties of the heel and tip are different than the blade center, in effect giving the user different zones of performance where required.
- The center section of the blade features dense patterning of the two stainless steels. Over time, as the blade is used, the two steels wear at different rates, creating micro serrations along the cutting edge and enabling precision slicing. This intense patterning also enhances the blade's food-releasing properties.
- Rounded heel for pinch-grip comfort.



**NEW!** Santoku 7"  
[TA0702]



**NEW!** Chef's 8"  
[TA0706]



**NEW!** Vegetable Cleaver 7"  
[TA0712]



旬  
SHUN

円月  
Engetsu

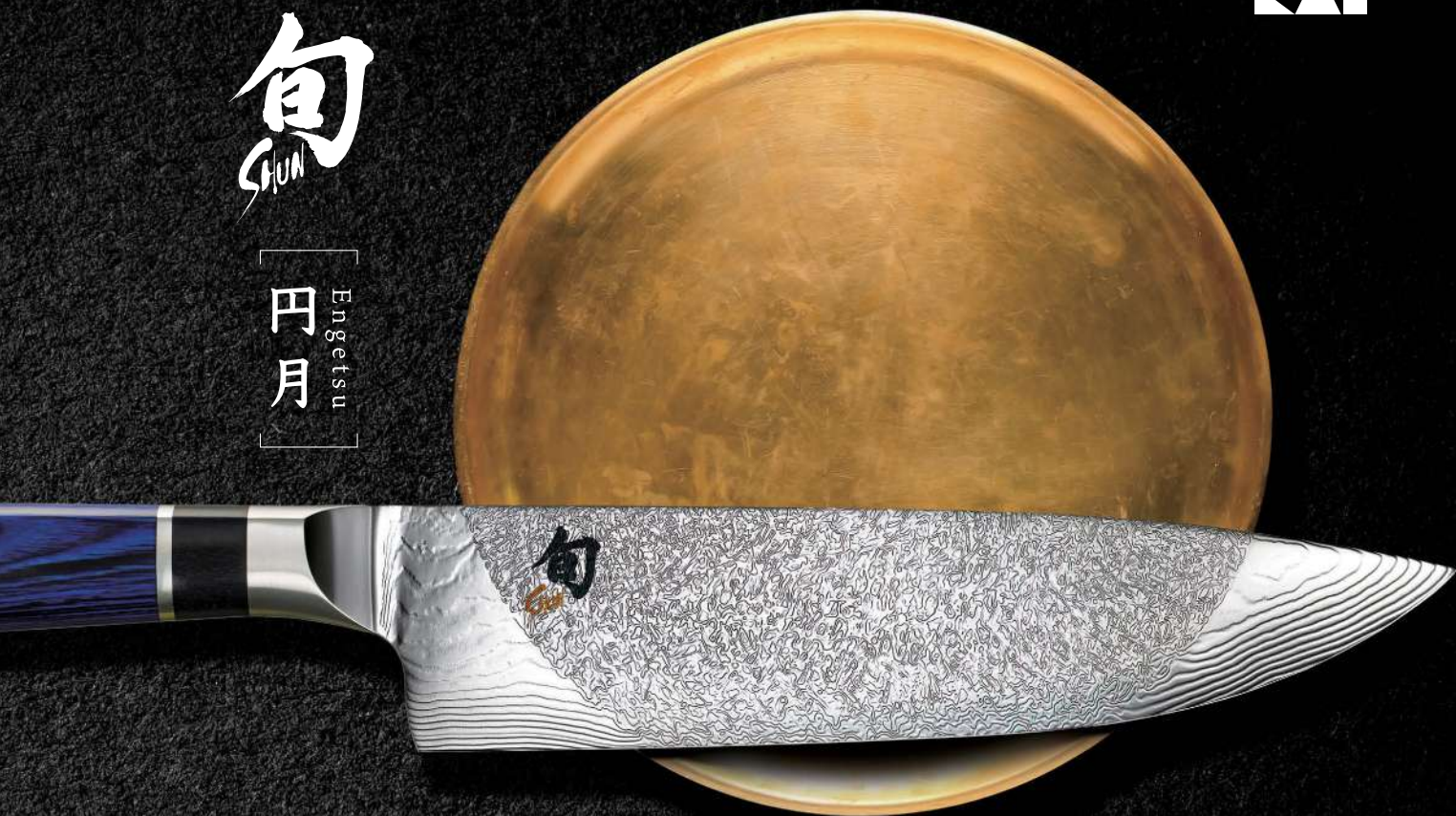

Engetsu.

The full moon rises.

Hardened steel and state-of-the-art technology.

The pinnacle of sharpness, born of Japanese heritage.

A truly unique blade pattern,  
found nowhere else in the world.

Its extraordinary design is sure to impress.

Since the beginning,

And eternally;

Ever present, every day.

Like the moon, it breathes color into life.

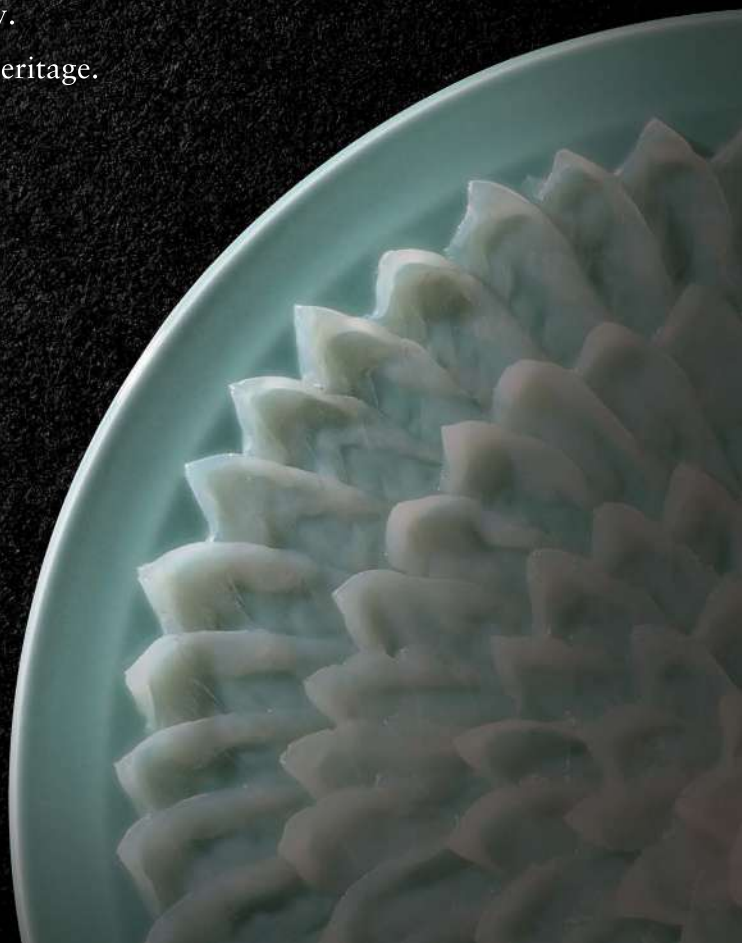

# Narukami

Are you one of the many cooks who swear by the performance of a carbon steel knife? Then we made this knife for you. Narukami, "thunderbolt" in Japanese, brings you the sharp, edge-holding performance of carbon steel in a strikingly styled kitchen knife. Cut with this handsome knife and the feeling is simple and confident. Yet it offers something others don't: easier care. Shun jackets the core with a layer of bead-blasted stainless steel on each side, making these knives easier to maintain. The stainless steel protects the core, while the bead blasting hides scratches and helps food release. Narukami is lightweight and nimble so every meal you cook can be the best yet.

**Cutting performance & easy re-sharpening** with Blue II carbon steel cutting core.

**Easier maintenance;** san mai cladding protects against corrosion, bead-blasting hides scratches, helps food release.

**Built to last:** full tang construction, riveted Micarta handles.

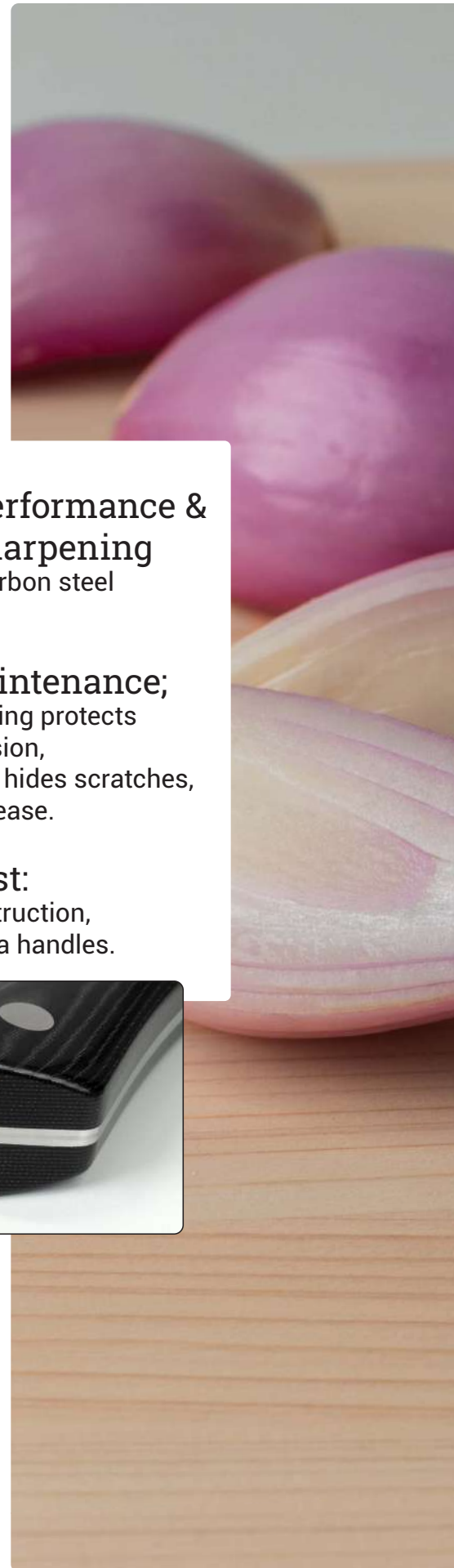







**NEW!** Paring 4"  
[VSC0700]



**NEW!** Utility 6"  
[VSC0701]



**NEW!** Master Utility 6.5"  
[VSC0782]  
Read more about specialty  
blade shapes on page 5



**NEW!** Chef's 8"  
[VSC0706]



**NEW!** Chef's 10"  
[VSC0707]



**NEW!** Combination Honing Steel 9"  
[SS0790]

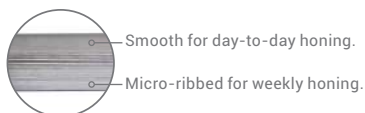

What is  
Blue II Carbon Steel?

Hitachi Blue II is a simple carbon steel alloy that takes a fine edge and can be re-sharpened easily. Additional alloying elements enable it to provide excellent edge retention and toughness. Yet, like all carbon steels, Blue II requires additional care. Cleaning and drying immediately is key. Over time, the edge will darken, developing a patina which, when formed, will also help protect the edge. Blue II is an exceptional cutlery steel.

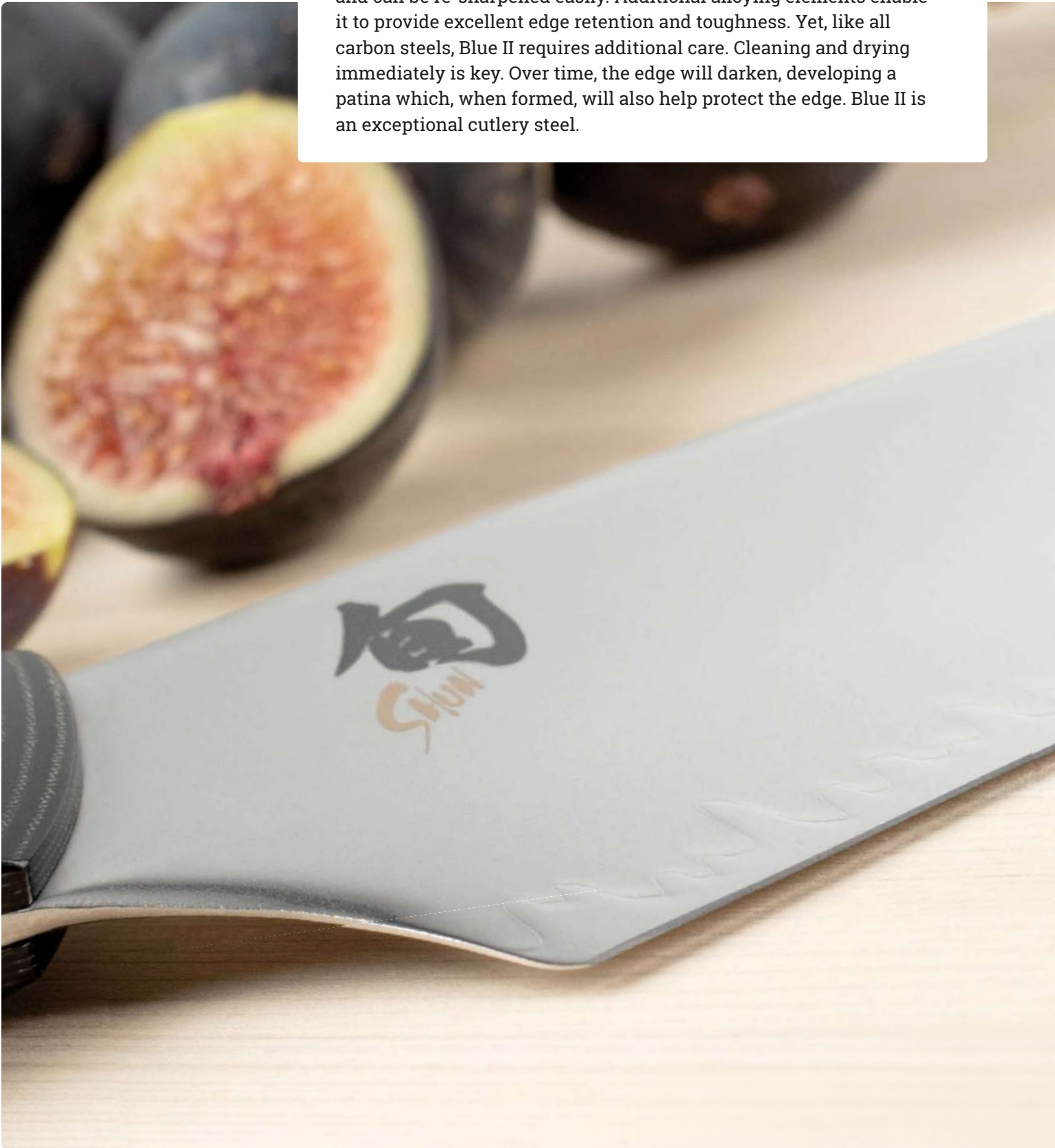

# Premier Grey

---

When you pick up a new kitchen knife, your reaction should be "ooh, ahh" rather than "ho hum." Pick up the new Shun Premier Grey and feel the agile lightness of the blade, the contoured comfort of the handle, and then enjoy the quick and easy work it makes of your meal prep. Premier Grey offers all the performance of our popular Premier series, with a sophisticated, cool-grey Pakkawood handle that's at home with any kitchen style. The grey handle is paired with a gloriously beautiful blade that is thin, hard, razor-sharp and helps make your time in the kitchen anything but ho-hum.

**Light, agile Premier performance**  
in a beautiful new handle color.

**Glide through meal preparation**  
with Shun's proprietary VG-MAX stainless steel cutting core.

**Perfect for left-or right-handed use**  
with Premier's comfortable, symmetrical handle and embossed endcap.



For more details on materials, see page 6





**NEW!** Paring 4"  
[TDM0700G]



**NEW!** Utility 6.5"  
[TDM0701G]



**NEW!** Santoku 7"  
[TDM0702G]



**NEW!** Nakiri 5.5"  
[TDM0742G]  
Read more about specialty  
blade shapes on page 5



**NEW!** Chef's 8"  
[TDM0706G]



Bread 9"  
[TDM0705G]

NEW!



Shun's 16° angle guide makes it easy to maintain the correct angle while honing.

Combination Honing Steel 9"  
[SS0790]

NEW!

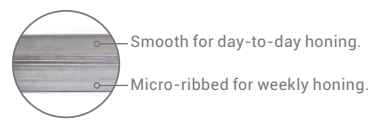

Smooth for day-to-day honing.  
Micro-ribbed for weekly honing.

Premier Grey 5 Pc Starter Block Set  
[TDMS0512G]  
Paring 4", Utility 6.5", Chef's 8", Combination Honing Steel 9"  
and 6-slot Bamboo Slimline Block



NEW!

# Dual Core

Simply stunning. Yet it's not just the incredible look of the blade; the true beauty of Dual Core is in the knife's advanced cutting performance. The balance is perfect. Dual Core is lightweight, highly maneuverable, and comfortable to use, even with hours of prep. And thanks to the blade's 71-layer construction, Dual Core maintains its high level of performance longer, so you can sharpen less. Dual Core's traditional Japanese octagon-shaped handle is secure and comfortable, making it a pleasure to use. Step up to Dual Core and step up to outstanding performance, graceful beauty, and ultra-premium quality.

## Exceptional cutting performance

with Dual Core's thin, light 71-micro-layer blade.

**Secure storage,**  
in the included wooden saya (sheath).

**Comfortable, secure grip**  
with traditional Japanese octagon handle; rabbit tang for lightweight maneuverability.









Utility/Butchery 6"

Includes wooden saya  
[VG0019]



Nakiri 6.5"

Includes wooden saya  
[VG0028]  
Read more about specialty  
blade shapes on page 5



Santoku 7"

Includes wooden saya  
[VG0021]



Kiritsuke 8"

Includes wooden saya  
[VG0017]  
Read more about specialty  
blade shapes on page 5

**BLADE  
SHOW  
WINNER**



Yanagiba 10.5"

Includes wooden saya  
[VG0020]  
Read more about specialty  
blade shapes on page 5

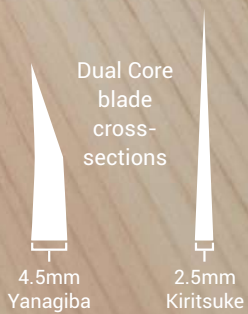

The Shun Dual Core Yanagiba has the length, weight, and single-bevel design of a traditional Japanese yanagiba. The blade stock is thicker than the rest of the Dual Core series (4.5mm vs 2.5mm). This gives the knife heft and rigidity to glide through cuts with ease. This single-bevel blade offers a strong, razor-sharp edge and simplified sharpening. A gentle hollow-grind on the back of the blade makes food release easier.

# Premier

Can you love a knife? According to Shun Premier owners worldwide, the clear answer is "yes." To understand, try Premier yourself. The balance and weight feel good, solid—yet without being heavy. The blade cuts, slices, dices, and minces with ease. No pressure, no muscling through the cut. The blade simply glides through, making cooking faster, easier, and much more satisfying. The fact that Premier is gorgeous doesn't hurt either. The delicate cladding and hammered tsuchime finish on the blade are beautiful, yes, but also help food release more quickly, which is just another very good reason to love Premier.

**Clean, easy cutting every time** with Shun's proprietary VG-MAX stainless steel cutting core and 69-layer Damascus construction.

**Food releases quickly from the blade** with the hammered tsuchime blade finish.

**Secure, comfortable handle** with its symmetrical design and embossed endcap.







Paring 4"  
[TDM0700]



Steak 5"  
[TDM0711]



Santoku 5.5"  
[TDM0727]



Nakiri 5.5"  
[TDM0742]  
Read more about specialty  
blade shapes on page 5



Ultimate Utility 6"  
[TDM0741]  
Read more about specialty  
blade shapes on page 5



Low frequency serrations  
for maximum cutting efficiency.

Premier 6 Pc Steak Knife Set  
[TDMS0660]  
Six Steak knives in a bamboo boxed set



Premier 4 Pc  
Steak Knife Set  
[TDMS0400]  
Four Steak knives in a  
gift-boxed set





Chef's 6"  
[TDM0723]



Boning/Fillet 6"  
[TDM0774]  
Read more about specialty  
blade shapes on page 5



Utility 6.5"  
[TDM0701]



Serrated Utility 6.5"  
[TDM0722]

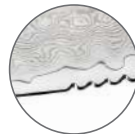

Serrations at the tip and heel go through tougher exterior and the smooth edge in the middle slices cleanly through a tender interior.



Santoku 7"  
[TDM0702]



Asian Cook's 7"  
[TDM0760]



Kiritsuke 8"  
[TDM0771]  
Read more about specialty  
blade shapes on page 5



Chef's 8"  
[TDM0706]

**BLADE  
SHOW  
WINNER**



Bread 9"  
[TDM0705]



Low frequency serrations  
for maximum cutting efficiency.



Slicing 9.5"  
[TDM0704]





Carving Fork 6.5"  
[TDM0709]



Combination Honing Steel 9"  
[TDM0790]

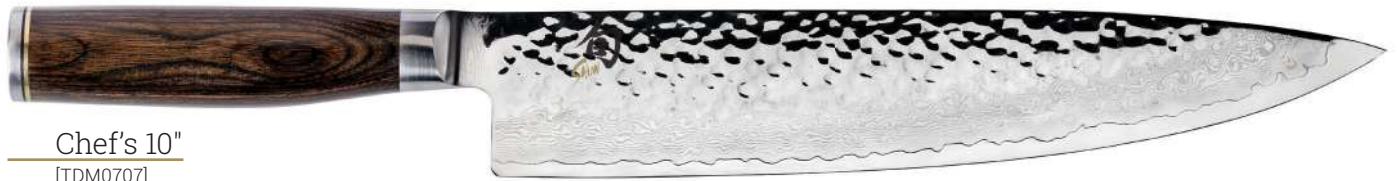
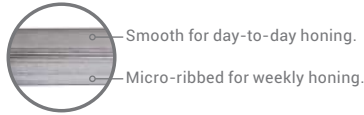

Chef's 10"  
[TDM0707]



Premier 2 Pc Carving Set

[TDMS0200]  
Slicing 9.5" and Carving Fork 6.5" in a gift-boxed set



Premier 3 Pc Starter Set

[TDMS0300]  
Paring 4", Utility 6.5" and Chef's 8" in a gift-boxed set

See page 55 for block sets

# Classic Blonde

It feels solid and elegant in the hand. Cutting is pure ease. The blade slices through everything from cabbage to herbs smoothly and cleanly. And it will continue to perform just as beautifully—without re-sharpening—longer, thanks to Shun's proprietary VG-MAX steel. Classic Blonde's perfect balance and sleek design make a chef's grip natural, giving you complete cutting control. The beautiful, blonde Pakkawood handles add refreshing lightness to the kitchen and help make every meal you prepare with these ultra-sharp, brilliantly balanced knives simple and satisfying. Enjoy all the performance of Shun's most popular knife series in a light-handled style that brings new brightness to your kitchen.

**Original Shun Classic styling**, now with beautiful, light-colored blonde handles.

**Premium cutting performance** with Shun's proprietary VG-MAX "super steel" and 69-layer Damascus construction.

**Secure, comfortable handle** in traditional Japanese D-shaped profile.



For more details on materials, see page 6





Paring 3.5"  
[DM0700W]



**NEW!** Steak 4.75"  
[DM0711W]



**NEW!** Santoku 5.5"  
[DM0727W]



Utility 6"  
[DM0701W]



**NEW!** Chef's 6"  
[DM0723W]

**NEW!**

Classic Blonde 4 Pc  
Steak Knife Set

[DMS400W]  
Four Steak knives in a  
gift-boxed set





Master Utility 6.5"

[DM0782W]  
Read more about specialty blade shapes on page 5



Santoku 7"

[DM0702W]



Chef's 8"

[DM0706W]



Bread 9"

[DM0705W]

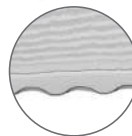

Low frequency serrations for maximum cutting efficiency.



Shun's 16° angle guide makes it easy to maintain the correct angle while honing.

Combination Honing Steel 9"

[SS0790]

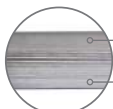

Smooth for day-to-day honing.

Micro-ribbed for weekly honing.

See page 54 for block set

# Classic

This is the knife that started a revolution. Shun Classic was the first to bring the beauty and unmatched cutting performance of fine Japanese handcrafted cutlery to a wider North American market. What does that mean to you? It means a seriously sharp kitchen knife that cuts through every kitchen task with ease and grace. Shun's thinner blade, made of harder steel, means a sharper edge that stays sharp longer. The traditional Japanese D-shaped handle provides a secure grip as you work and lets you breeze through every detail of your prep. Try Shun Classic and let its beauty and performance revolutionize your own cooking.

**Find the right knife for every task;**  
Classic offers the largest number of blade shapes of any Shun series.

**Trusted by professionals;**  
Shun Classic is NSF Certified for use in commercial kitchens.

**Glide through every kitchen chore**  
with Classic's VG-MAX "super steel", beautiful 69-layer Damascus construction, and D-shaped handle.



For more details on materials, see page 6





Bird's Beak 2.5"  
[DM0715]



Paring 3.5"  
[DM0700]



Paring 4"  
[DM0716]



Asian Multi-Prep 4.5"  
[DM0749]  
Read more about specialty  
blade shapes on page 5



Steak 4.75"  
[DM0711]



Santoku 5.5"  
[DM0727]

Classic 6 Pc Steak Knife Set

[DMS0660]

Six Steak knives in a bamboo boxed set



Classic 4 Pc  
Steak Knife Set

[DMS400]

Four Steak knives in a  
gift-boxed set







Utility 6"  
[DM0701]



Serrated Utility 6"  
[DM0722]

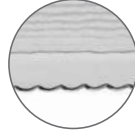

Unlike jagged sawtooth serrations, Classic Utility serrations are rounded for a smoother, easier cut.



Ultimate Utility 6"  
[DM0741]  
Read more about specialty blade shapes on page 5

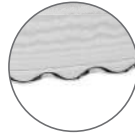

Low frequency serrations for maximum cutting efficiency.



Chef's 6"  
[DM0723]



Meat Cleaver 6"  
[DM0767]

Made with Japanese AUS8A steel for heavier duty tasks such as breaking down chicken and thick-skinned vegetables, like spaghetti and butternut squash.



Boning/Fillet 6"  
[DM0743]  
Read more about specialty blade shapes on page 5



Master Utility 6.5"

[DM0782]

Read more about specialty blade shapes on page 5



Nakiri 6.5"

[DM0728]

Read more about specialty blade shapes on page 5



Asian Cook's 7"

[DM0760]

**BLADE  
SHOW  
WINNER**



Hollow Ground Santoku 7"

[DM0718]



Flexible Fillet 7"

[DM0761]

DM0761 is made with Japanese AUS8A steel for flexibility & toughness





Vegetable Cleaver 7"  
[DM0712]



Chef's 8"  
[DM0706]



Western Cook's 8"  
[DM0766]

The DM0766, identified by a black accent stripe near the bolster, is sharpened to a 22° angle on each side for heavier duty tasks such as breaking down chicken and thick-skinned vegetables, like spaghetti and butternut squash.



Hollow Ground Chef's 8"  
[DM0719]



Kiritsuke 8"  
[DM0771]

Read more about specialty blade shapes on page 5



Offset Bread 8.25"  
[DM0724]

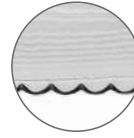

Scalloped serrations slice cleanly, for a smoother, easier cut.



Bread 9"  
[DM0705]

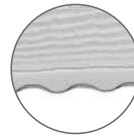

Low frequency serrations for maximum cutting efficiency.



Hollow Ground Slicing 9"  
[DM0720]



Chef's 10"  
[DM0707]



Hollow Ground Brisket 12"

Includes wooden saya  
[DM0778]

Read more about specialty blade shapes on page 5



### Carving Fork 6.5"

[DM0709]

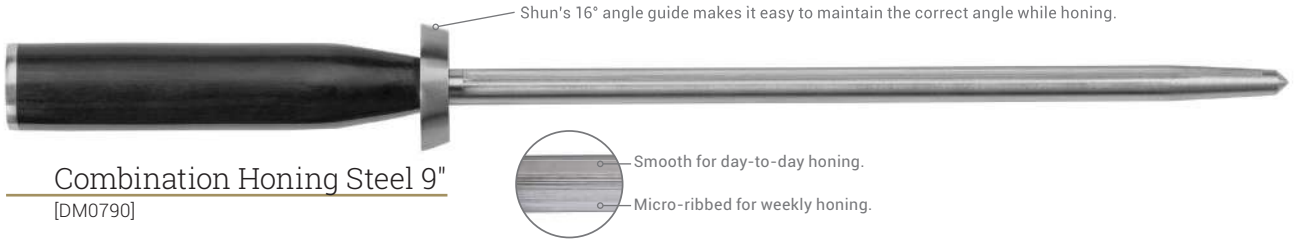

Shun's 16° angle guide makes it easy to maintain the correct angle while honing.

### Combination Honing Steel 9"

[DM0790]

Smooth for day-to-day honing.  
Micro-ribbed for weekly honing.

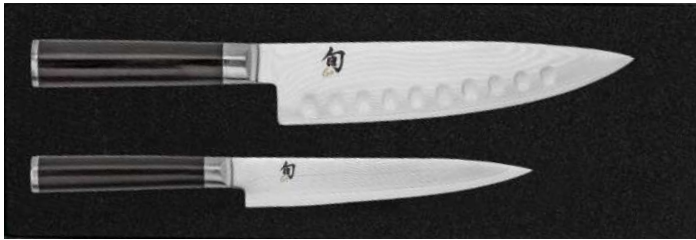

### Classic 2 Pc Starter Set

[DMS0245]

Utility 6", Hollow Ground Chef's 8" in a gift-boxed set

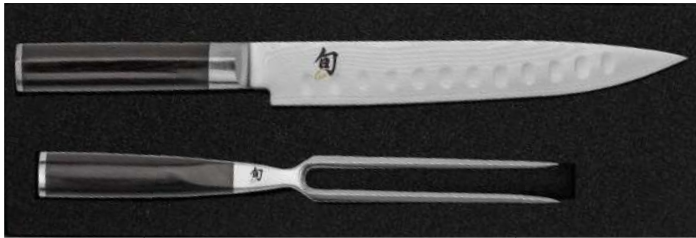

### Classic 2 Pc Carving Set

[DMS0230]

Hollow Ground Slicing knife 9" and Carving Fork 6.5" in a gift-boxed set



### Classic 3 Pc Starter Set

[DMS300]

Paring 3.5", Utility 6", Chef's 8" in a gift-boxed set

See page 56 for block sets

# Kanso

Shun Kanso is built on the Zen principle of simplicity. You can see it in the knife's simple, graceful design. There's nothing extra, nothing overdone—yet the knife's Heritage blade finish and “iron sword wood” handles are undoubtedly eye-catching. You can feel it in the simple precision of each cut. Kanso's sharp edge and perfect balance make food preparation easy, whether you're removing seeds from a jalapeno or portioning meat. Cooking with Kanso feels simple and natural, like the knife is an extension of your arm. From its razor-sharp blade and ideal balance to the precision cutting control it provides, Kanso is simply perfect.

**Built for lifetime performance;**  
AUS10A high-carbon stainless blade; Heritage finish hides use scratches.

**Precision balance & strength**  
with full tang construction.

**Comfortable handle**  
of contoured tagayasan (wenge) wood; designed for left/right-handed use.



For more details on materials, see page 6





Paring 3.5"  
[SWT0700]



Steak 5"  
[SWT0711]



Asian Multi-Prep 5"  
[SWT0729]  
Read more about specialty  
blade shapes on page 5



Hollow Ground  
Santoku 5.5"  
[SWT0727]



Utility 6"  
[SWT0701]



Boning/Fillet 6.5"  
[SWT0743]  
Read more about specialty  
blade shapes on page 5



Hollow Ground Nakiri 6.5"  
[SWT0728]  
Read more about specialty  
blade shapes on page 5

Kanso 6 Pc Steak Knife Set

[SWTS0660]  
Six Steak knives in a bamboo boxed set



Kanso 4 Pc  
Steak Knife Set

[SWTS0430]  
Four Steak knives in a  
gift-boxed set



Kanso 3 Pc Starter Set

[SWTS0351]  
Paring 3.5", Utility 6", Chef's 8" in a  
gift-boxed set







Hollow Ground Santoku 7"  
[SWT0718]



Asian Utility 7"  
[SWT0767]  
Read more about specialty  
blade shapes on page 5



Chef's 8"  
[SWT0706]



Bread 9"  
[SWT0705]



Hollow Ground  
Brisket 12"  
Includes wooden saya  
[SWT0778]  
Read more about specialty  
blade shapes on page 5



Combination Honing Steel 9"  
[SWT0790]

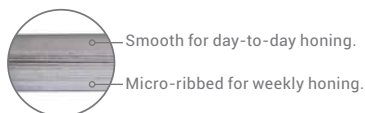

See page 57 for block sets

# Sora

How can kitchen cutlery this budget-friendly offer the truly astonishing performance you experience when you cook with Sora? The secret is Shun's proprietary Composite Blade Technology. It joins two steels in one blade and puts advanced steel along the cutting edge—where it's needed. The result is cutting performance that is smooth and easy in a perfectly balanced kitchen knife that feels wonderfully comfortable to hold. It even gets rave reviews from professionals. Our Composite Blade Technology gives Sora unmatched style, too. Where the two steels meet, a wavy line is formed. We call it a "modern hamon." You'll just call it beautiful.

**Performance & value;**  
Shun puts advanced VG10 stainless steel on the cutting edge.

**Used by pros;**  
NSF Certified for commercial kitchen use.

**Comfortable, easy-grip handle**  
provides strength and balance; blade tang extends to handle emblem.







Paring 3.5"  
[VB0700]



Utility 6"  
[VB0701]



Serrated Utility 5.5"  
[VB0722]



Unlike jagged sawtooth serrations, Sora Utility serrations are rounded for a smoother, easier cut.



Hollow Ground Santoku 5.5"  
[VB0740]



Ultimate Utility 6"  
[VB0741]

Read more about specialty blade shapes on page 5

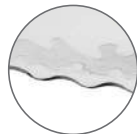

Low frequency serrations for maximum cutting efficiency.



Chef's 6"  
[VB0723]



Hollow Ground Santoku 7"  
[VB0718]



Chef's 8"  
[VB0706]



Bread 9"  
[VB0705]

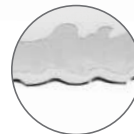

Push-pull serrations  
for maximum cutting efficiency.



Combination Honing Steel 9"  
[VB0790]

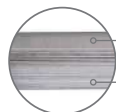

Smooth for day-to-day honing.  
Micro-ribbed for weekly honing.

See page 57 for block sets

# Shun exclusives

In addition to the beautiful Shun Cutlery series you'll see in this catalog, Shun also creates these exquisite exclusives.



## Shun Fuji

SG2 cutting core  
Hammered tsuchime finish  
Full composite tang  
Tagayasan (or wenge) wood handle  
*Williams-Sonoma exclusive*



## Shun Hikari

Dual Core construction  
Full composite tang  
Blonde PakkaWood® handles  
*Williams-Sonoma exclusive*



## Shun Kaji

SG2 cutting core  
Full composite tang  
Ebony PakkaWood® handles  
*Williams-Sonoma exclusive*



## Shun Premier Blonde

Proprietary VG-MAX™ cutting core  
Hammered tsuchime finish  
Full composite tang  
Blonde PakkaWood® handles  
*Williams-Sonoma exclusive*



# Kai Housewares products

Kai, the makers of Shun Cutlery, also offer an exciting collection of Kai Housewares products. From the commercial-grade PRO series to colorful Pure Komachi 2, Kai Housewares provides quality and value.



NSF Certified  
for use in  
professional  
kitchens



## Kai Pro

Japanese AUS6M stainless steel  
Hammered tsuchime finish  
Full tang, riveted POM handle



## Wasabi

Japanese 1K6 stainless steel  
Graze finish  
Traditional Japanese-style polypropylene handle



## Seki Magoroku

Composite Blade Technology  
Proprietary VG-MAX™ cutting core  
Blonde PakkaWood® handle



## Luna

German DIN1.4116 stainless steel  
Hammered tsuchime finish  
Molded resin handle with soft-grip overlays



## Inspire

German DIN1.4116 stainless steel  
Hammered tsuchime finish  
Molded resin handle



## Pure Komachi 2

Coated 3CR13MOV stainless steel  
Food-safe color coated blade  
Molded resin handle



# Block sets

## Premier Grey

Premier Grey 5 Pc Starter Block Set  
[TDMS0512G]  
Paring 4", Utility 6.5", Chef's 8", Combination Honing  
Steel 9" and 6-slot Bamboo Slimline Block



NEW Series!

## Classic Blonde

Classic Blonde 5 Pc Starter Block Set  
[DMS0530W]  
Paring 3.5", Utility 6", Chef's 8", Combination Honing  
Steel 9" and 6-slot Bamboo Slimline Block





Premier 5 Pc Starter Block Set  
 [TDMS0512]  
 Paring 4", Utility 6.5", Chef's 8",  
 Combination Honing Steel 9" and  
 6-slot Bamboo Slimline Block



Premier 3 Pc Build-a-Block Set  
 [TDMS2200K]  
 Chef's 8", Combination Honing Steel 9"  
 and 6-slot Bamboo Slimline Block



Premier 7 Pc Essential Block Set  
 [TDMS0700]  
 Paring 4", Utility 6.5", Chef's 8", Bread 9",  
 Herb Shears, Combination Honing Steel 9"  
 and 11-slot Bamboo Block



# Premier



Premier 8 Pc Professional  
 Block Set  
 [TDMS0808]  
 Paring 4", Santoku 5.5", Utility  
 6.5", Chef's 8", Bread 9", Slicing  
 9.5", Combination Honing Steel  
 9" and 11-slot Bamboo Block

Set configurations may change without notice

Classic 3 Pc Build-a-Block Set  
[DMS2200K]  
Chef's 8", Combination Honing Steel 9"  
and 6-slot Bamboo Slimline Block



Classic 5 Pc Starter Block Set  
[DMS0530]  
Paring 3.5", Utility 6", Chef's 8",  
Combination Honing Steel 9" and  
6-slot Bamboo Slimline Block



Classic 7 Pc Essential Block Set  
[DM2003B]  
Paring 3.5", Utility 6", Chef's 8", Bread  
9", Herb Shears, Combination Honing  
Steel 9" and 11-slot Bamboo Block



# Classic

Classic 9 Pc Chef's Choice Block Set  
[DMS0934]  
Paring 3.5", Santoku 5.5", Utility 6", Boning/  
Fillet 6", Chef's 8", Offset Bread 8.25",  
Hollow-Ground Slicing 9", Combination  
Honing Steel 9" and 22-slot Bamboo Block



Set configurations may change without notice

Kanso 5 Pc Starter Block Set  
[SWTS0500]  
Paring 3.5", Utility 6", Chef's 8",  
Combination Honing Steel 9" and  
6-slot Bamboo Slimline Block



Kanso 3 Pc Build-a-Block Set  
[SWTS2200K]  
Chef's 8", Combination Honing  
Steel 9" and 6-slot Bamboo  
Slimline Block



# Kanso



Kanso 6 Pc Block Set  
[SWTS0600]  
Paring 3.5", Hollow Ground  
Santoku 5.5", Utility 6", Chef's 8",  
Combination Honing Steel 9"  
and 8-slot Block

# Sora

Sora 6 Pc Block Set  
[VBS0600]  
Paring 3.5", Utility 6",  
Chef's 8", Herb Shears,  
Combination Honing Steel 9"  
and 13-slot Bamboo Block



Sora 3 Pc Build-a-Block Set  
[VBS3310]  
Chef's 8", Combination Honing  
Steel 9" and 6-slot Bamboo  
Slimline Block



Set configurations may change without notice

# Student Sets



Sora 5 Pc Student Set  
[VBS0499]  
Paring 3.5", Chef's 8", Bread 9",  
Combination Honing Steel 9" and  
Shun 8-slot Knife Roll



Shun's Student Knife Sets include the key knives culinary students will use in their classes every day. For an exceptional value, choose our 5-Piece Sora Student Set. For a set with a wider selection of key kitchen knives, choose the Shun Classic 8-Piece Student Set.



Classic 8 Pc Student Set  
[DMS0899]  
Paring 3.5", Utility 6", Boning/Fillet  
6", Chef's 8", HG Slicing 9", Bread 9",  
Combination Honing Steel 9"  
and Shun 8-Slot Knife Roll



# BBQ Sets



Classic 4 Pc BBQ Set  
[DMS0450]  
Asian Multi-Prep 4.5", Boning/Fillet 6", Hollow  
Ground Brisket 12" and Shun 8-slot Knife Roll



Shun BBQ Sets feature the three key knives you'll need to handle grill-worthy proteins of all types. They all come in a handsome Shun knife roll, perfect for when you take your BBQ show on the road. These gorgeous sets include the Asian Multi-Prep, the Boning/Fillet Knife, and the Brisket Knife, ideal for trimming and slicing larger cuts of meat, including roasts, brisket, ham, and turkey. The Brisket Knife includes its own wooden saya, or sheath.



Kanso 4 Pc BBQ Set  
[SWTS0450]  
Asian Multi-Prep 5.5", Boning/Fillet 6.5",  
Brisket Knife 12" and Shun 8-slot Knife Roll



# Hinoki Cutting Boards

Hinoki wood is renowned for its beauty and delicate fragrance. Used in a cutting board, this medium-soft wood "gives" as you cut, helping to preserve the sharp edges of your fine Shun cutlery. Quite simply, hinoki is the perfect cutting surface for all your finest knives.

The wood for Shun's hinoki products is grown in Japan and is Forest Stewardship Council (FSC) Certified for sustainable forest management practices. In addition, all of our hinoki products are made from wood resulting from forest thinning, which is required to maintain healthy growth



Shun Classic 8" Chef's shown for reference



## Small Hinoki Board

[DM0814]  
10.75" x 8.25" x 0.5"



## Medium Hinoki Board

[DM0816]  
15.75" x 10.75" x 0.5"

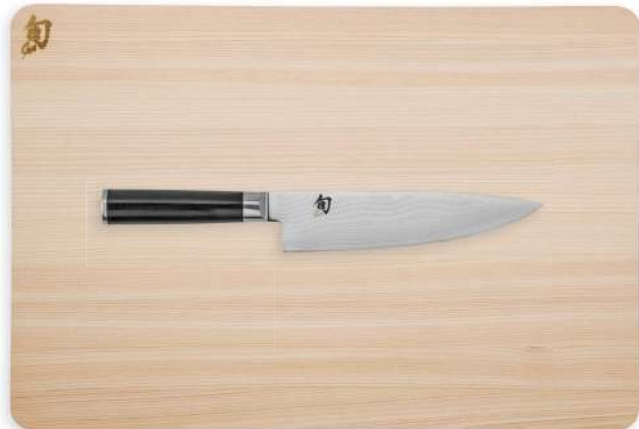

## Large Hinoki Board

[DM0817]  
17.75" x 11.75" x 0.75"

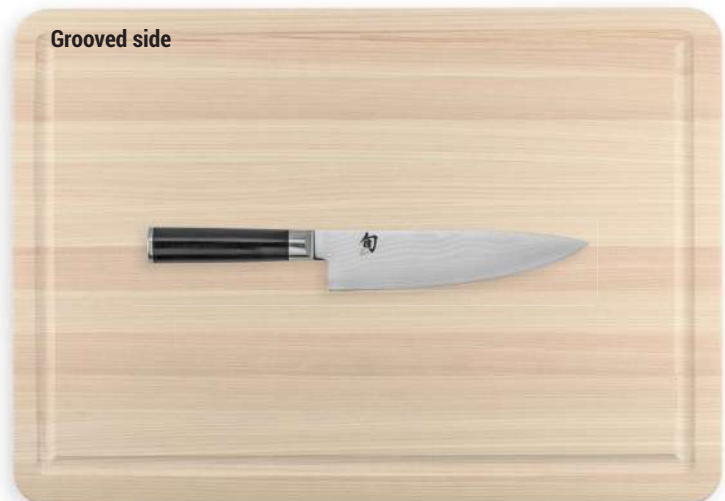

## Large Hinoki Board with Juice Groove

[DM0819]  
20" x 14" x 1"

# Steak Knives

Shun steak knives are non-serrated. A fine edge cuts more cleanly, preserving the texture and flavor of your steak, and is easier to re-sharpen when needed.



**4 PC SET**  
[DMS400W]



**Classic Blonde Steak Knife 4.75"**  
[DM0711W]

**NEW!**



**4 PC SET**  
[DMS0435]



**Shima Natural 4-pc Steak Knife Set**  
[DMS0435] (Available in 4-pc set only)  
Steel: High-carbon AUS8A Japanese stainless steel  
Handle: Tagaysan (Wenge)



**4 PC SET**  
[DMS0430]



**Classic Shima 4-pc Steak Knife Set**  
[DMS0430] (Available in 4-pc set only)  
Steel: High-carbon AUS8A Japanese stainless steel  
Handle: Ebony PakkaWood® with inlaid rondels



**6 PC SET**  
[SWTS0660]



**4 PC SET**  
[SWTS0430]



**Kanzo Steak Knife 5"**  
[SWT0711]



**6 PC SET**  
[DMS0660]



**4 PC SET**  
[DMS400]



**Classic Steak Knife 4.75"**  
[DM0711]



**6 PC SET**  
[TDM0660]



**4 PC SET**  
[TDM0400]



**Premier Steak Knife 5"**  
[TDM0711]

## Shun Higo No-Kami

[DM5900]

This beautifully crafted folding knife is an extremely handsome accessory, whether carried as a tasteful pocket knife or a personal steak knife for use at your favorite restaurant.



# Accessories

"Pho" apron (pictured) [SHUNAPRON10]

"Dashi" apron [SHUNAPRON11]

"Stingray" apron [SHUNAPRON12]

Made to Shun's exacting specifications by Hedley & Bennett, manufacturers of professional chefs' gear, these handsome aprons are clean, simple, comfortable, durable—and will keep you looking like a pro.

Choose from three colors and fabrics: "stingray," a light grey 100% cotton canvas, "pho," a dark grey stretch denim, or "dashi," a soft, Japanese denim in navy with a woven herringbone pattern.

All three aprons feature adjustable neck strap, double pen chest pockets, a right-side towel loop, and a large lap pocket.



Available in three colors and fabrics

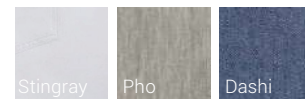

Shun Fish Bone  
Tweezers 5.5"  
[DM0901]



Beveled edge  
for precise  
bone removal

#1 top recommended  
shears by a leading  
consumer publication

Shun  
Multi-purpose  
Shears 9"  
[DM7300]



All Shun shears separate  
for easy cleaning

Shun Kitchen Shears 9"  
[DM7240]

fine  
Cooking  
Editor's  
favorite



2 Pc  
Shears  
Set  
[DMS7000]  
Includes  
DM7240  
and DM7100

Shun Herb  
Shears 7.5"  
[DM7100]





Kai Serrated Knife Sharpener  
[AP0163ENG]  
Sharpens  
wide  
serrated  
blades!



Diamond Ceramic  
Knife Sharpener  
[AP0138]  
3 stage sharpener  
from coarse to fine.



3 Pc Whetstone  
Sharpening System  
[DM0610]  
Includes 1000 Grit/6000 Grit  
whetstone, Combination Honing  
Steel and 16° angled stand



Knife Care Kit  
[DM0625]  
Includes food-  
grade knife oil 2  
oz., rust removal  
and polishing  
boards, talc  
powder ball,  
Shun polishing  
cloths and user  
instructions



## Combination Whetstones & Leveling Stone

Shun introduces three new combination-grit whetstones so you'll always have just the grit you need—whether you're just touching up your edge or re-sharpening completely. To keep your whetstones perfectly flat for precision sharpening, try our new leveling stone, too.

Combination  
Whetstone  
[SSM0708]  
400 Grit/1000 Grit



Combination  
Whetstone  
[SSM0600]  
1000 Grit/6000 Grit



Combination  
Whetstone  
[SSM0800]  
1000 Grit/3000 Grit



Combination  
Whetstone  
[SSM0900]  
3000 Grit/6000 Grit



Leveling Stone  
[SLM0500]



NEW!

NEW!



### Universal Sayas

Small: [BG0700]  
Medium: [BG0701]  
Large: [BG0806]

See website for a complete list of compatible knives.

NEW!



Always sheath your knives before placing in roll



open



closed

### Shun 8-slot Knife Roll (Grey)

[DM0884]  
Unfolded 20" x 18",  
Folded 20" x 6.5"  
(Knives not included)



open

### Chef's 20-slot Knife Case (Grey)

[DM0886]  
Unfolded 20" x 20",  
Folded 10" x 20" x 3.75"  
(Knives not included)



closed



closed

### Shun 8-slot Knife Roll (Black)

[DM0880]  
Unfolded 20" x 18",  
Folded 20" x 6.5"  
(Knives not included)



open



open

### Chef's 20-slot Knife Case (Black)

[DM0882]  
Unfolded 20" x 20",  
Folded 10" x 20" x 3.75"  
(Knives not included)



closed



11-Slot Bamboo Block  
[DM0831]



22-Slot Bamboo Block  
[DM0832]



6-Slot Bamboo Slimline Block  
[DM0845]



6-Slot Bamboo Slimline Block  
(Dark)  
[DM0846]



17-Slot Angled Block  
[DM0848]



8-Slot Angled Block  
[DM0839]



22-Slot Block (Dark)  
[DM0854]



13-Slot Bamboo Block  
[DM0830]



8-Slot Kickstand Block  
[DM0838]



6-Slot Bamboo Sidecar  
Steak Knife Block  
[DM0842]



15-Slot In-Drawer  
Knife Tray  
[DM0856]  
Dimensions: 10" x 17.5" x 2.5"

NEW!



DM0838  
3.5"W x  
11"H x  
16"D



DM0848  
5.75"W x  
10.75"H x  
13.75"D



DM0839  
3"W x  
9.75"H x  
12"D



DM0832  
6.25"W x  
9"H x  
12.5"D



DM0854  
6.25"W x  
9.25"H x  
12.75"D



DM0830  
4.75"W x  
9.5"H x  
13.75"D



DM0831  
5"W x  
9.25"H x  
12.75"D



DM0845 & DM0846  
3"W x  
8"H x  
9.5"D



DM0842  
2"W x  
7.75"H x  
7"D

10 in.  
5 in.  
0 in.  
65

# Quality Control

As beautiful as Shun is on the outside, and as beautifully as it performs in your kitchen, its true beauty may be in what you don't see.

## Beauty on the inside, too

Although Shun cutlery is always beautiful to behold, what makes Shun knives truly extraordinary isn't always so obvious. For instance, the steel that is at the heart of every knife. While many steels may look alike on the outside, inside they're not the same. The formula—the recipe—for any particular steel can make a significant difference in how it handles in fine cutlery. A little less vanadium or carbon here or there and performance can be affected. Shun uses the most advanced steels and we rigorously test to ensure that the steel formula is precisely what it should be for top performance every time.

## The importance of heat treatment

Another invisible, yet vital process is heat treatment. This exacting process is fundamentally important to ensuring that your Shun provides lasting value. In heat treatment, the metal is heated and cooled to change its microstructure, bringing out its very best properties. With precise heat treatment, blade steel becomes finer grained, making it stronger and harder so blades can be thinner, sharper, and give you a longer-lasting edge. Shun's experts are, quite simply, masters of the heat treatment process.

## Expert inspection

Our highly trained and experienced Quality Control professionals check each Shun to ensure precision and performance. Shun knives are inspected throughout the handcrafting process in Japan, and they're inspected and tested again when they arrive at Kai USA in Portland, Oregon.

## Third-party testing

We make sure the "fit and finish" of each knife is precise. Using advanced machinery, we make sure the angles of our hand-sharpened blades are accurate. But then we go a step further, sending our knives to independent testing laboratories to guarantee each Shun meets—and will continue to meet—our demanding specifications. This third-party testing ensures that Shun steel is what we say it is, Shun hardness is what we say it is, and the processes used for



Above: A Shun Classic Chef's blade is cut for a cross-section.

Right: Cross-section of a blade mounted in a resin "puck" for inspection using an electron microscope.

sharpening and finishing our fine cutlery are exactly what we say they are.

## Precise tolerances

One example is steel hardness. Hardness is rated on the Rockwell Hardness Scale. Most Shun blades are hardened to our target of 60 (+1, -1.5) on the Rockwell scale. A hard blade like that can be sharpened to a more acute edge and will hold its edge longer. Shun factories hold to precise tolerances to ensure quality you can count on; Shun inspection processes ensure those tolerances are met every time.

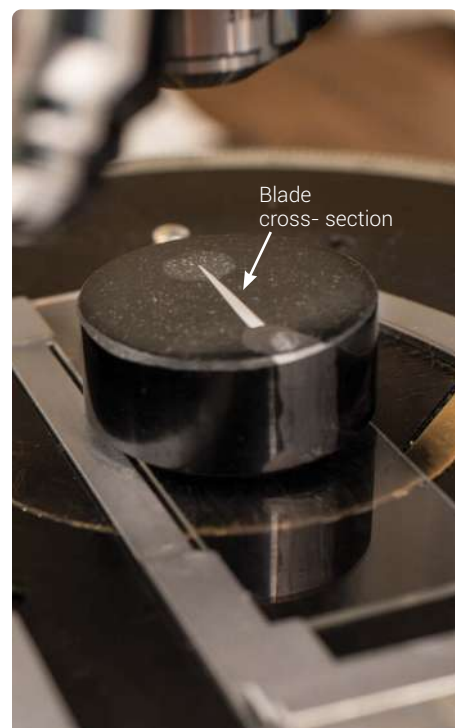

# Use & Care

If this is your first Japanese knife, congratulations! To keep your fine Shun cutlery performing at the highest level and to maintain its striking beauty, follow these tips for how to best use and care for your knife.



## Caring for your Shun natural wood accessories

We recommend the following simple care to keep your Shun natural wood accessories looking beautiful and performing their best.

### Knife block care

- Keep clean by wiping with a damp cloth
- After cleaning, dry block immediately; never soak
- Apply mineral oil sparingly anytime the block surface appears dry or shows scratches

### Cutting board care

- Wet cutting board before each use to help it resist staining
- Wash with mild detergent; towel dry, then let air-dry away from direct sunlight
- Do not put in dishwasher



## Cutting technique

Shun cutlery is designed to be used in a smooth, slicing motion—never in an up-and-down “chopping” manner. Imagine cutting wood with a handsaw, then slice through your food with a similar motion, intentionally pushing the knife forward and down as you slice, then pulling it back toward your body. Always pay attention to where your fingers are in relation to the knife. Your skill and experience level should determine the speed at which you cut. When first slicing with a Shun, it's best to slow down and enjoy the effortless precision and cutting ability of your new knife.

Use your Shun knives on meats and vegetables only, not on bones or very thick-skinned vegetables. For this heavier kitchen work, try the Shun Classic Meat Cleaver (DM0767), or Shun Classic 8” Western Chef’s Knife (DM0766), which are designed to handle more aggressive work in the kitchen, such as breaking down chicken and preparing thick-skinned vegetables like butternut squash or melons.

## Cutting surface

The cutting surface you use makes a big difference in keeping your knives sharp. A good cutting board will help retain a sharp edge for substantially longer. Soft woods, such as hinoki, are preferred. Tile, ceramic, synthetic, marble, granite, or any kind of glass cutting boards are not recommended and can be harmful to your knives.

## Storage

It is best to store your Shun cutlery in a wooden block, in-drawer knife tray, sheath, or knife case. Do not store your knives unsheathed in a drawer.

## Washing & drying

It is important to protect your investment by hand washing your knives with gentle dish soap. Do not use soaps with citrus extracts or bleach; they can promote rust. Rinse and towel dry immediately. Take extra time to get ALL of the water/moisture off the sharp cutting edge. Although the wood used in the handles has been stabilized, it is natural, and like all wood, may shrink in very arid environments or swell in very humid environments. The handle color may change slightly over time due to oils in the hand as well as the natural color change of wood from oxidation and/or exposure to light. This is not a defect, just a natural part of the process.

# Honing & Sharpening



To keep your knives in great shape, hone regularly, and sharpen occasionally. Why? Honing doesn't remove metal from the blade, sharpening does. Sharpen only when you need it.

## Why does my knife feel dull?

Every time your knife contacts the cutting board, there's an impact on the blade. That's not a flaw; it's just part of using a knife. Over time and many impacts, the thin edge of the blade will naturally curl over. This is called a "rolled edge." The edge is still sharp, but because the edge is curled, the sharpest part is no longer what is moving directly through the food as you cut.



### Enter the honing steel

A honing steel enables you to re-align—or uncurl—the edge so that the razor-sharp edge is once again gliding through the food as you cut. To hone, align the flat side of the blade with the 16° angle guide on the hand guard of your Shun honing steel. Maintaining that angle, gently pull the blade down the steel from heel of blade to tip. Some cooks hone once a week, some hone every day. It just depends on how much you use your knives. Either way, you will be amazed at the difference it makes when you cut. Check our YouTube channel (Shun Cutlery) for more on how to hone.

### Honing has its limitations

When your knife's edge is severely rolled, and honing is no longer effective in bringing the "sharp" back, then it's time for real sharpening. Whenever you sharpen your knife, a bit of the metal is removed. But that's no cause for concern. Your Shun can be sharpened again and again to return it to razor-sharp performance.



### Best for sharpening? The whetstone

When sharpening on a whetstone, it's important to make sure the knife is sharpened at the correct 16° angle and to maintain a consistent angle along the entire cutting edge as you sharpen. But remember, only sharpen when you really need it. Once a year is probably more than enough for most home cooks. Professionals, of course, will need to sharpen more often. If you prefer hands-on sharpening, we recommend learning how to use a whetstone. The Shun 3-Piece Sharpening Set includes a base that helps you maintain the correct angle more easily. Seasoned sharpeners will like our new lineup of four whetstones and leveling stone.

## Prefer not to sharpen yourself?

No problem. In fact, the easiest way to ensure your knives are sharpened correctly is to send them to us. We offer FREE sharpening for the lifetime of your Shun.

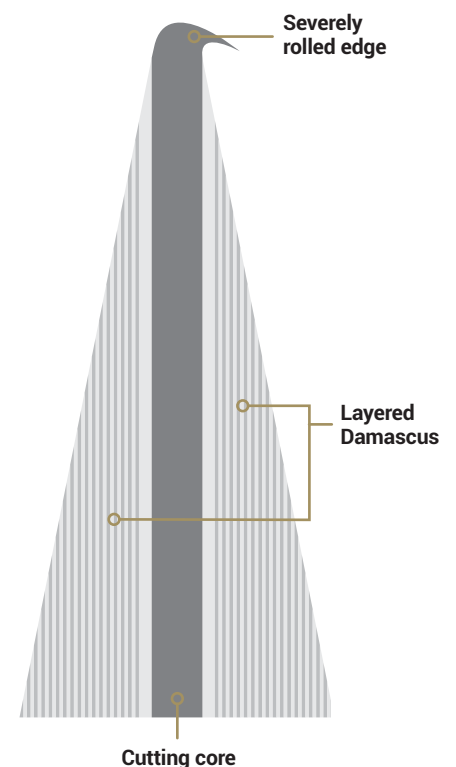
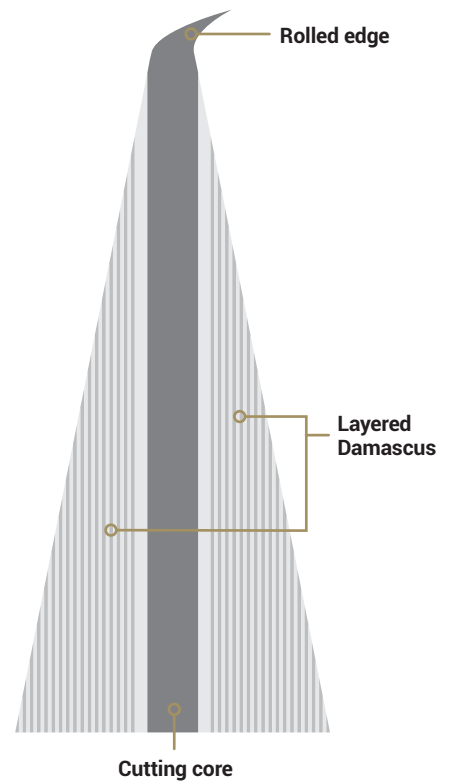



# We're here to help

Even though Shun cutlery is handcrafted in Japan, if you purchased your knives in the USA, Canada, or Mexico, you don't have to return them to Japan for sharpening or warranty service. Instead, send them to us at Kai USA in Oregon. See our website for the required forms and details. If you purchased your Shun knives outside of the USA, Canada, or Mexico, please return them for service to the authorized dealer from whom you originally purchased them.





# Free sharpening service

Your Shun performs best when the edge is sharpened to our razor-sharp 16° angle on each side. If you prefer not to sharpen them yourself, we'd be happy to sharpen any Shun knife for free for the lifetime of the owner. It's as simple as that. You pay for shipping and processing, and our expert sharpening services are FREE. When we sharpen your knives in our Tualatin, Oregon facility we use the same type of horizontal sharpening wheel used to put the original edge on your Shuns in Japan. Called a hiromai, this sharpening wheel—and the skill of our knife care experts—ensures a Shun-sharp edge every time.

# Sign up for our newsletter

Stay up-to-date on the latest Shun and Kai Housewares product news. Receive special discounts and offers just for our subscribers. You can also create a Shun account on our website. You'll get faster checkout, an easier way to check on the status of your orders, and more.

**Register your Shun**  
Please visit [shuncutlery.com](http://shuncutlery.com)  
to register your knife

# Got questions?

Please visit our website at [shuncutlery.com](http://shuncutlery.com) for additional information on our products and services.

# Warranties

Shun brand products sold by Kai USA and our authorized dealers are backed by warranties against manufacturing defects. Please note that normal wear is not a manufacturing defect but simply a result of using your knife.

## LIMITED LIFETIME WARRANTY

Unless otherwise stated here, Shun cutlery from Kai USA Ltd. carries a limited warranty for the lifetime of the original owner. We guarantee our cutlery will perform as advertised when properly used and maintained, and is free of manufacturing defects in material and construction. The Limited Lifetime Warranty is non-transferable and does not extend to normal signs of wear, rust, damage or breakage due to improper use, improper maintenance, accidents, loss or theft. Any product we determine to be defective will be repaired or replaced solely at our discretion. To receive warranty repair or replacement, the owner must send the product to be evaluated by Kai USA Warranty Services in our Tualatin, Oregon headquarters. In addition to the provisions of this warranty, the owner may also have other rights that can vary by state. No other warranties are implied or expressed other than what is specifically stated here. If you have a warranty concern, please DO NOT return your knife to the place of purchase.

## WOOD ACCESSORIES 90-DAY WARRANTY

Shun's wood accessories are made of natural materials that will show wear over time. This is not a defect. Our 90-Day Warranty protects you against original manufacturing defects, but not natural wear. Please see our website for warranty details.

## LIABILITY DISCLAIMER

**WARNING!** Knives are extremely sharp tools and should only be used with the utmost care and caution. Knives are intended to be used for cutting purposes only. Do not use this knife for stabbing or piercing. Use your Shun knives on meats and vegetables only, not on bones or very thick-skinned vegetables. For this heavier kitchen work, try the Shun Classic Meat Cleaver (DM0767), or Shun Classic 8" Western Chef's Knife (DM0766), which are designed to handle more aggressive work in the kitchen, such as breaking down chicken and preparing thick-skinned vegetables like butternut squash or melons. Any use other than cutting is considered misuse and abuse—and will void your warranty. Please visit [shuncutlery.com](http://shuncutlery.com) for more information. **WARNING!** Knives are extremely sharp tools and should only be used with the utmost care and caution. Knives are intended to be used for cutting purposes only. Do not use this knife for stabbing or piercing. Use your Shun knives on meats and vegetables only, not on bones or very thick-skinned vegetables. For this heavier kitchen work, try the Shun Classic Meat Cleaver (DM0767), or Shun Classic 8" Western Chef's Knife (DM0766), which are designed to handle more aggressive work in the kitchen, such as breaking down chicken and preparing thick-skinned vegetables like butternut squash or melons. Any use other than cutting is considered misuse and abuse and will void your warranty.

# Series comparison

BLADE FEATURES	
Dual Core VG2/VG10	Made of two premium high-carbon stainless steels in alternating micro layers; produces a finer grain in the steel for strength and beauty
VG-MAX™ cutting core	Shun's proprietary VG-MAX is the latest in the VG line of "super steels;" wear and corrosion resistant, holds a fine, sharp edge
VG10 "super steel"	This high-performance high-carbon stainless steel is tough, stain resistant, and takes/holds a fine edge
Solid AUS10A	A high-carbon stainless steel with high strength, as well as good corrosion resistance, hardness, and wear resistance. Added vanadium refines the grain of the steel so that it takes a fine edge
Blue II Carbon Steel	A simple carbon steel alloy that takes a fine edge, re-sharpens easily. Includes additional elements that enable it to provide superior edge retention and toughness.
Composite Blade Technology	Proprietary Shun technology that joins two steels in one blade and enables Shun to put high-performance steel where it belongs—on the cutting edge
Stainless steel layered Damascus	Supports the cutting core; offers enhanced stain resistance
San mai stainless steel Damascus cladding	3-layer construction; single outer layer on each side protects and supports cutting core
Tsuchime ("hammered")	Hammering creates tiny pockets of air that act as hollow-ground cavities to reduce drag and quickly release food from the blade
Double bevel; 16° cutting angle each side	Edge is sharpened on both sides of the blade, provides control and ease of cutting
Single bevel; 16° cutting angle	The traditional Japanese single-bevel blade offers an exceptionally strong, sharp edge that is easy to resharpen
Full(F)/Composite(C) tang	Enables the knife handle to attach to the blade, provides strength and balance
Rabbit tang	The tang extends into the handle, but not all the way to the end; this is the way samurai swords were commonly made
HANDLE MATERIAL	
PakkaWood®	Premium, resin-impregnated hardwood resists moisture, is strong and durable
Tagayasan (or wenge)	Known as "iron sword wood," tagayasan is notable for its denseness, durability, and simple beauty
Micarta	A durable laminate made from resins layered with a variety of different types of fabrics. Micarta can handle extremes of heat or cold, resists moisture, and is extremely stable.
Textured PP/TPE	Provides excellent grip, balance, and easy maintenance
HANDLE GRIP	
Symmetrical (ambidextrous)	Handle is shaped the same on both sides enabling left- or right-handed use
Asymmetrical	Traditional Japanese D-shaped handle nestles into the curve of the right hand; yet some left-handed users prefer it



	ENGETSU	NARUKAMI	PREMIER GREY	DUAL CORE	PREMIER	CLASSIC BLONDE	CLASSIC	KANSO	SORA
	◆			◆					
			◆		◆	◆	◆		
								◆	◆
							◆		
		◆							
									◆
	◆ 71 layers total		◆ 68 layers plus core	◆ 71 layers total	◆ 68 layers plus core	◆ 68 layers plus core	◆ 68 layers plus core		
		◆ 2 layers plus core							◆ 2 layers plus core
			◆		◆				
	◆	◆	◆	◆	◆	◆	◆	◆	◆
				◆ Yanagiba only					
	◆ (C)	◆ (F)	◆ (C)		◆ (C)	◆ (C)	◆ (C)	◆ (F)	
				◆					◆
	◆		◆	◆	◆	◆	◆		
								◆	
		◆							
									◆
	◆	◆	◆	◆	◆			◆	◆
						◆	◆		



## Talk to one of our Authorized Dealers.

You can be sure you're getting genuine Shun quality, fully backed by our famous Limited Lifetime Warranty, when you purchase from our Authorized Dealers. These dealers are specially selected for their ability to professionally represent and sell our fine kitchen cutlery and accessories. We are proud to do business with them and you will be, too.