

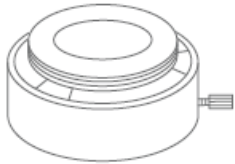



Moticam X⁵

Start Guide

This camera is a delicate instrument and should be handled with care. When not in use, please store the camera in a safe place with the dust cap attached. Do not let the camera get in contact with water or expose it to extreme temperatures (below 0 or above 50 degrees Celsius). In order to receive the highest level of service, please retain your receipt as proof of purchase.

Included Parts

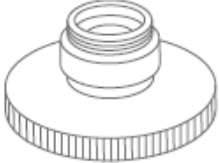
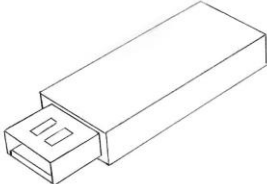
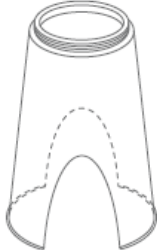
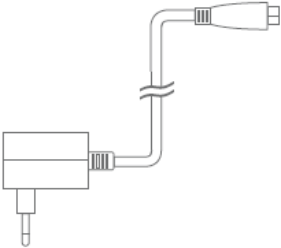
	Moticam X5		Eyepiece Adapter (2)
	Calibration Slide		Dust Cap
	C-Ring		Focusable Lens
	Motic Images USB Stick		Macro Tube
	Power Adapter		

MoticomX5 Camera Specification

Name	MoticomX5	Notes
Sensor Size	1/3 " CMOS	
Sensor Effective area	5.44 x 3.07 mm	
Pixels Size	2.0 x 2.0 um	
Resolutions	2592 x 1520	Still mode – MotiConnect, Browser, and Software
	1920 x 1080 (Maximum Resolution) 1280 x 720	Live mode - MotiConnect
	1920 x 1080 1280 x 720 640 x 360	Live mode – Browser and Software
Scanning mode	Progressive	
Capture	Still and live Images capture with MotiConnect app and Software	Still capture only by Browser
White Balance	AWB and different White Balance modes	
Frame Rates	UP to 9fps @ 2.4Ghz	
	15~30fps @ 5Ghz	5Ghz device with H264 hardware required for Fast Display mode. Not available in Browser mode.
S/N Ratio	38.1dB	
Dynamic Range	70.1dB	
Output	RJ45 Wi-Fi	
Wi-Fi Standard	IEEE802.11b/g/n/ac	2.4Ghz by default – Normal Mode 5Ghz – Fast Mode
Wi-Fi Output Power	5dB	
SSID	MCX5_XXXXXX	User can set own SSID (XXXXXX is 6 Hex codes)
Working Distance	<10m	Recommend camera and mobile devices be within line of site
Antenna	PCB board type Dual Antennas	
Power Input	DC +12V	
Power Consumption	Power supplies from external power supply : ≤5.0W	
Working Temp	0°C ~ 50°C	

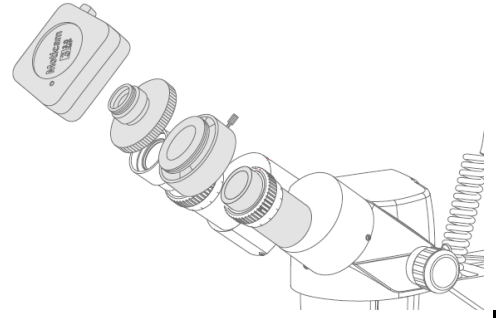

Storage
Temp

—10°C ~ 60°C

Using the Camera On the eyepiece

1. Install the Motic Images Plus application program from the USB stick included.
2. Remove the Dust Cap from the camera and attach the focusable lens
3. Choose the right size eyepiece adapter and attach this to the focusable lens
4. Attach the assembly to your microscope's eyepiece by tightening the centering screws on the eyepiece adapter.
5. Connect the USB power adapter to the camera. The blue light will flash and turn solid when the camera is in operation.
6. Connect to the Moticam X⁵ WiFi signal. Please see the instructions on page 3

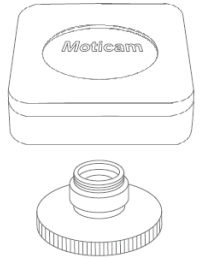

Using the camera as a Macro Camera

1. Install the Motic Images application program from the USB stick included.
2. Remove the Dust Cap from the camera and attach the focusable lens
3. Attach the Macro Tube onto the lens
4. Place the assembly over the item you wish to view and ensure there is adequate lighting. If necessary, a desk lamp is a good solution
5. Connect the USB power supply to the camera. The blue light will flash and turn solid when the camera is in operation.
6. Connect to the Moticam X⁵ WiFi signal. Please see the instructions on Page 3

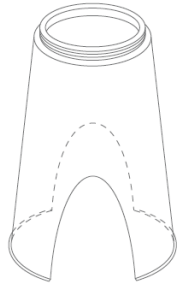

Using the Camera on a Trinocular Microscope

1. Install the Moticam Images Plus application program from the USB stick included.
2. Remove the Dust Cap from the camera and attach the microscope's C-Mount adapter (*Please note that the C-Mount adapter is specific to microscope. Depending on the type of adapter and microscope, the C-Mount adapter may be necessary between the camera and the C-Mount adapter).
3. Connect the USB power supply to the camera. The blue light will flash turn solid when the camera is in operation.
4. Connect to the Moticam X⁵ WiFi signal. Please see the instructions on page 3

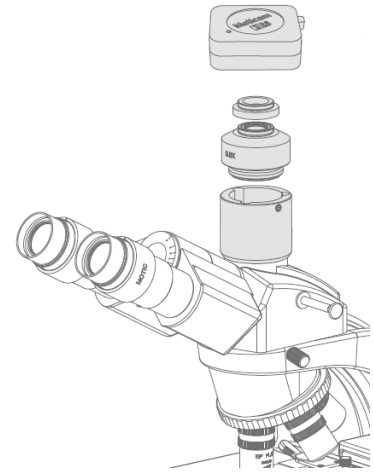

your
Ring
and
Page

Camera Registration

It is important to make sure you have registered your device on the Motic Images website:

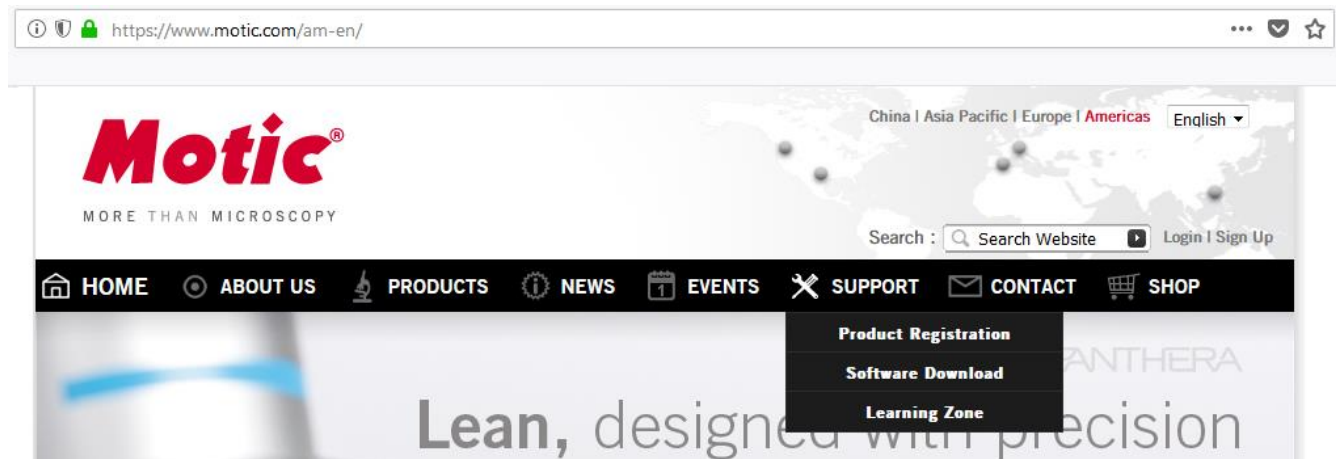

Connect to the Moticam X⁵ WiFi signal

1. Each Moticam X5 transmits its own WiFi signal to which you can directly connect your WiFi Device.
2. The Moticam X5's SSID signal is printed on a label on the camera. To log into your camera, simply connect your WiFi device to that signal. The password for the network by default is 12345678.

Using a WiFi device that operates with Android or IOS

1. For best performance, we recommend to use WiFi devices, such as tablets, with a screen not smaller than 7 inches. For iOS devices we suggest using iOS 5 or higher while for Android Devices we suggest using Version 4.0 or Higher.
2. To operate and use the camera on your tablet, please download our free App called MotiConnect. For iPad you can find this on the AppStore, for Android devices you can find this on Google Play.
3. You can also use certain web browsers such as Chrome, Firefox, or Safari to view, measure, and capture without the need of the App. To view the camera stream on the browser, please type in the IP number also shown on the label on the camera. For example 192.168.1.151:8080 and you will be connected straight to the camera.

Use the Moticam X⁵ on your WiFi enabled computer

The Moticam X⁵ can also be used with Motic Images Plus software for Windows computers. If you use a WiFi enabled laptop you can install Motic Images Plus from the USB stick provided. To view the camera in our product's MI Devices interface, simply connect your computer to the Moticam X⁵ WiFi signal. Then open the MI Devices interface by clicking on the camera icon within Motic Images Plus. From the MI interface select Moticam X⁵ in the device box and click Open.

Switching the Moticam X⁵ between 2.4Ghz and 5Ghz

First, always make sure you have installed the latest version of the MotiConnect App or Motic Images software. Secondly make sure you are using a device with confirmed 5Ghz capability. Failure to use a 5Ghz device will render the camera unusable until a 5Ghz device is connected. The Moticam X5 SSID will not be visible to any 2.4Ghz devices in 5Ghz mode. Please note this step. 5Ghz mode will allow for faster frame rates for improved video and screen resolution.

1. With your 5Ghz ready device open the IP app using any HTML5 browser.
2. When the browser opens, type in the following in the address bar:
 - <http://192.168.1.151:8080>
3. When the MotiConnect webpage opens, select the configure tab.
4. Under Access Point, locate Channel.
5. By default the Channel will be either 1 or 6: See picture below

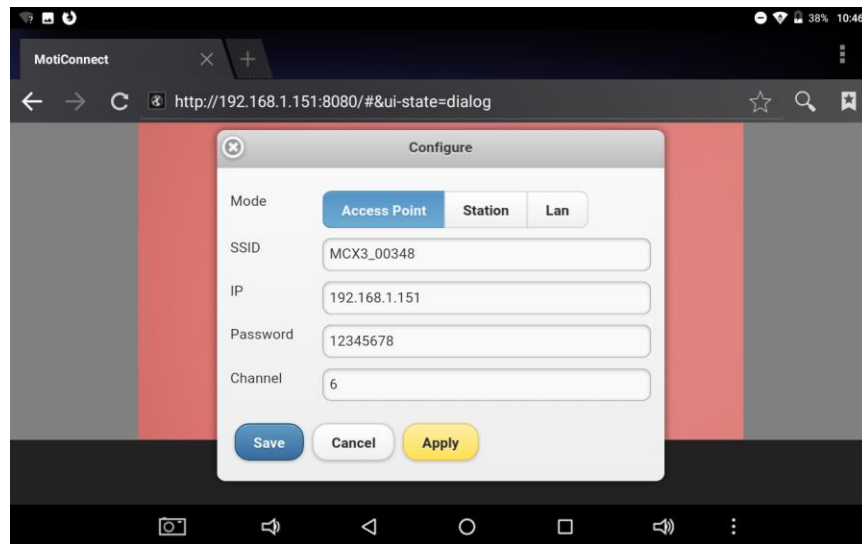

6. When using either Channel 1 or 6, the camera can be used in 2.4Ghz mode. Typically Channel 6 works best.
7. If you wish to change the camera mode to 5Ghz, change the Channel to 149 or 157

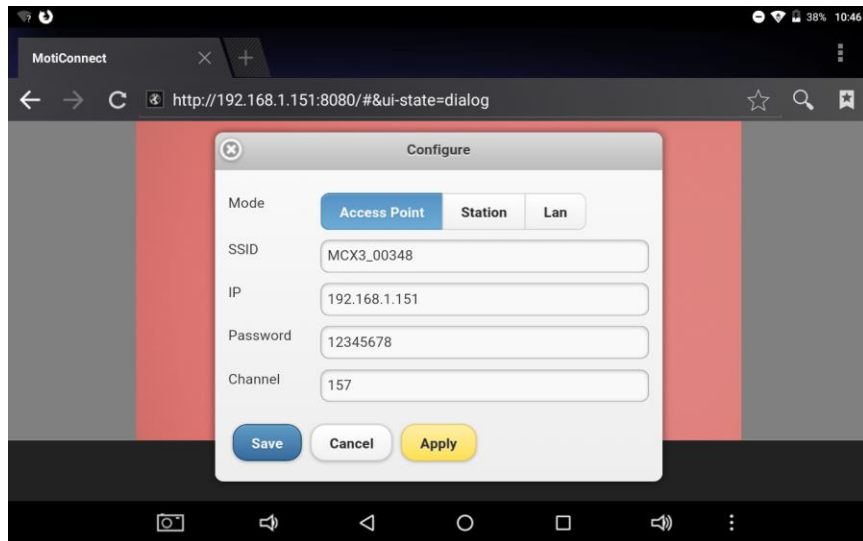

8. Once changed, you will need to click on **Save** first, then **Apply**. Make sure to write down any and all changes you make on this tab. Any changes made here will affect how you connect to the camera later.
9. **Once you click Apply, the camera will disconnect and no longer be available for detection on any 2.4Ghz devices.**
10. With your 5Ghz device, locate the camera on your available WiFi devices. The SSID and Password will remain the same unless you changed it on the Configure Tab.
11. Open the MotiConnect app, select image adjustment icon, select H264, close and re-open the app.
12. There should be a noticeable increase in frames per second. (FPS rate will vary by device)

MOTICAM X5 Information:

- The Moticam X5 by default operates in 2.4Ghz mode.
 1. Allows for connection to devices without 5Ghz compatibility.
- In 2.4GHz mode, frame rates will be much slower, comparable to the Moticam X and X2.
- When the X5 is switched on (first time) it resets to JPG mode.
- JPG mode is the default mode at 2.4Ghz.
- In order switch the camera into 5Ghz mode, end user tablets / phones must have H264 hardware decoding.
 1. End user is responsible for finding this information from device manufacture.
 2. White BTX tablet has H264 hardware and is 5Ghz compatible.
- Whenever the X5 is used with an HTML browser, the X5 will automatically switch to jpg mode. The JPG mode will remain for both browser and app, until the X5 is reset again (off and on).
- Normally the app should provide much faster (up to 30 fps) frame rates when it is in H264 mode, but is still subject to the device's H264 chip.
- H264 mode must be selected, in 5Ghz mode and found under the image settings tab of MotiConnect app, to achieve faster frame rates. Once selected the app must be reopened.
- In the event of a reset, the X5, will keep the original default SSID, password, 2.4GHz settings
- In browser mode, the X5 will not be able to provide 30 fps, in either 2.4Ghz or 5Ghz mode.
- In browser mode, the best the X5 can only achieve is 15 fps at 1280X720 or lower resolution. However, this can vary from device to device.

HTML BROWSER:

- Browsers will only support the camera in JPG mode
- Will average 2-7fps in full HD mode.
- Most devices, such as Chromebooks, older laptops, older PCs (with WiFi), and older tablets will require the Moticom X5 to operate in 2.4GHz mode
- Operation and frame rates comparable to the Moticom X and X2.

MOTICONNECT:

- The app supports both jpg mode and H264 mode.
- Can be used at both 2.4Ghz and 5Ghz.
- Fast frame rate can only be achieved if:
 1. The tablet/device is 5Ghz compatible
 2. The table/device is using the MotiConnect app