

Door opening up to 1 m/s:
The fastest sectional door
from Europe's no. 1

INDUSTRIAL SECTIONAL DOORS

NEW. Series 60 – faster – smarter – safer

HÖRMANN





4

Good reasons
to try Hörmann
sectional doors.



22

Application areas.



36

Versions.
Accessories.
Technology.

Brand quality made in Germany



The family-owned company Hörmann offers all important construction components for building and renovating projects from a single source. We manufacture in highly specialised factories using state-of-the-art production technologies. Our employees work intensively on new products, continual further developments and improvements to details. The results are patents and unique products on the market.





AN EYE ON THE FUTURE. Hörmann is setting a good example. That's why 100 % of our electricity needs in Germany come from green electricity. Together with an intelligent and certified energy management system, CO₂-neutral mailing and the recycling of valuable materials, more than 40000 tons of CO₂ are saved each year. In addition, we offset over 100000 tonnes of CO₂ by promoting wind energy and reforestation projects in cooperation with ClimatePartner.



You can find further information at
www.hoermann.de/umwelt



Sustainable planning for trend-setting construction

Experienced specialists within our customer-oriented sales organisation accompany you from the planning stage, through technical clarification up to the final building inspection. Complete working documentation, such as, e.g. technical manuals, is always accessible and up-to-date at www.hoermann.com.





SUSTAINABILITY DOCUMENTED. Hörmann has already received confirmation of sustainability through an Environmental Product Declaration (EPD) in accordance with ISO 14025 from the Institut für Fenstertechnik (ift – Institute of window technology) in Rosenheim, Germany. This EPD was created based on EN ISO 14025:2011 and EN 15804:2012. In addition, the general guidelines for the preparation of type III Environmental Product Declaration apply. The declaration is based on the PCR document “Doors” PCR-TT-1.1:2011.

ARCHITECTS’ PROGRAM. Clearly structured navigation via drop-down menus and symbols, as well as a search function, provide faster access to texts for invitations to tenders and more than 9000 drawings (in DWG and PDF format) of over 850 Hörmann products. In addition, BIM data can be provided for many products for the Building Information Modelling process, enabling efficient planning, drafting, construction and management of buildings. Photos and photo-realistic presentations provide additional information on many products.



Plan with the Architects’ Program
at <https://architektenprogramm.hoermann.de>

ENERGY SAVINGS COMPASS. An integrated calculation module estimates the amortisation period for door and loading technology systems. The energy savings compass is available as a web-based interface for PC / Mac and mobile end devices.



**PRODUCTS
FOR BIM**

We are a member of the professional association for digital building products in the Federal Association of Building Systems e.V.

Easy to fit and service

Perfectly fitting connections, few components and pressed-in screws enable fast, precise fitting. In addition, the new generation of industrial sectional doors can also be integrated into digital service and remote maintenance concepts. This lowers the maintenance and service costs, making Hörmann industrial sectional doors economical and sustainable.





Round-the-clock service

FAST SERVICE. Our teams of highly qualified specialists travel all around Germany. But Hörmann also offers consulting, maintenance and repairs in many other countries. Our network of over 500 service technicians guarantees speed and flexibility. We are available around the clock. Our customers can rely on us.



10-year guaranteed availability

HÖRMANN SPARE PARTS. Doors, operators and controls come with a guaranteed availability of 10 years.

SMART DOOR CONFIGURATION. Initial start-up, service and maintenance of industrial doors is easy and convenient with the new BlueControl app. Important door information, such as error messages or door cycles, can be accessed via the SmartControl online portal. This reduces costs for service visits and prevents downtime through preventive replacement of wear parts. For robust logistics processes with regard to your door system.

→ For further information, see from page 84.



Long-lasting design

Track rollers with ball-bearings, robust section connections and an optimal counterbalance enable over 25000 actuations – and up to 200000 with special equipment. The optional plastic frame shoe offers the frame long-term protection against corrosion.





Only from Hörmann

Double radius of 510 mm

LOW-WEAR DOOR TRAVEL. NEW. The frame construction with a large double radius and optimally dimensioned rollers is gentle on all mechanical door elements.



Only from Hörmann

Twin rollers on the top door section

QUIET OPENING AND CLOSING. NEW. The standard twin rollers **1** on the top section ensure quiet door travel, especially during closing. With optional 2-component rollers **2** travel noises are reduced by up to an additional 5 dB(A). This is a crucial advantage, not only for doors in residential buildings.



Only from Hörmann

Plastic frame shoe

CORROSION PROTECTION. NEW. The optional fibreglass-reinforced plastic frame shoe **3** prevents the frame from coming into direct contact with moisture on the floor and provides lasting protection against corrosion. Together with the door's bottom seal, the frame shoe makes for a bottom edge that is visually appealing.

→ For further information, see from page 54.

Convenient operator solutions

For frequent door cycles we recommend the use of a power-driven door. Depending on the requirements regarding performance, speed and convenience, we offer you perfectly matched operator solutions with suitable safety equipment, operating aids and signal transmitters. This optimally supports the work processes of your company, making it an investment that quickly pays off.





Soft start
Soft stop



Opening speed
up to 1.0 m/sec

ULTRA-FAST DOOR OPENING. NEW. Shaft operator WA 500 FU impresses with an opening speed of up to 1 m/s, speeding up logistics processes and reducing thermal losses. The frequency converter control with soft start and soft stop also takes stress off the mechanical door elements, guaranteeing quiet door travel. With the ITO 500 FU operator developed especially for underground garages, the door achieves an opening speed of up to 0.5 m/s.

→ For further information, see from page 76.



NON-CONTACT SAFETY. Efficient monitoring of the closing edge increases safety. The operators WA 400 / ITO 400, WA 500 FU / ITO 500 FU optionally come with leading photocell VL 1-LE, which responds to movements and obstacles without any contact, reliably stopping the door if necessary – at no surcharge.

→ For further information, see from page 88.

Efficient thermal insulation

Well-insulated industrial doors are essential in heated buildings to keep energy losses at a minimum. Doors with thermal break and ThermoFrame also improve thermal insulation. High-quality seals on the side frames, lintel and floor as standard reduce thermal losses. The optional ribbing infill, corner seals and lintel counter seal help achieve even better airtightness.

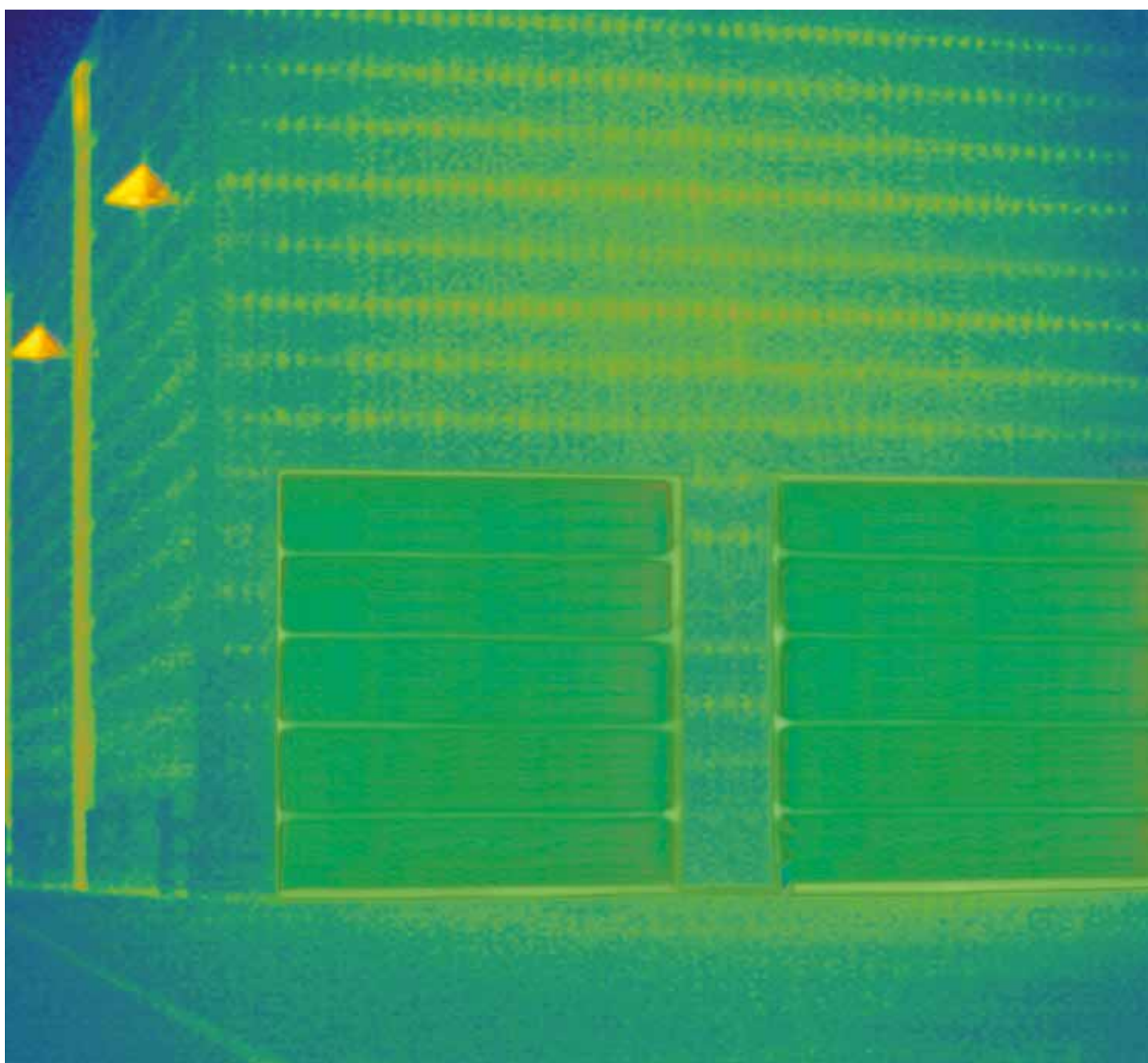



Optimal thermal insulation

U-value of up to 0.51 W/(m²·K)

ENERGY-SAVING DOORS. The steel sectional doors and aluminium sectional doors with 67 mm depth with thermal break feature excellent thermal insulation, saving you valuable energy costs. With optional quadruple panes or climate glass, the thermal insulation value can be optimised even further.

→ For further information, see from page 38.



Up to 21 %

Improved thermal insulation

THERMOFRAME. The optional ThermoFrame forms a thermal break between the frame and brickwork, and the double seals ensure optimal door sealing. This improves the thermal insulation and airtightness of your door and the frame is also protected against corrosion.

→ For further information, see page 71.



Perfect transparency

Aluminium frame doors lend buildings more light and an elegant look. The standard Duratec synthetic glazing offers a permanently clear view, and the matching aluminium profiles convince with a harmonious overall appearance. This also applies to the combination of doors with different depths. This way, your company always makes an impression.





Only from Hörmann
Duratec glazing



Duratec
Extremely scratch-resistant

A PERMANENTLY CLEAR VIEW. A special surface coating, similar to that used on car headlights, protects the Duratec glazing from scratches and damage caused by cleaning over the long term. This preserves the attractive appearance despite heavy use in rough industrial settings. The Duratec glazing is available as standard for all sectional doors with clear synthetic glazing.



Watch the “Duratec glazing – maximum scratch resistance” video at: www.hoermann.com/videos

HARMONIOUS DESIGN. Sectional doors, doors with wicket door, side doors and panels are designed in such a way that all elements present a harmonious overall view when they are fitted in a line of buildings. The rails of the aluminium frames are aligned to match – for both standard profiles and profiles with thermal break, both with depth 42 and depth 67.

Detailed solutions for more convenience and security

We offer you a wide range of optional equipment, allowing you to easily tailor each door to your requirements. For example, a wicket door with trip-free threshold for convenient passage. Optional adjustable rotary latches and shootbolts, including in combination with an exterior handle to securely and conveniently close the door from the outside, or the RC 2 security equipment provide additional security.





Only from Hörmann
Anti-lift kit on both sides



Anti-lift kit as standard



Optional RC 2 safety equipment
Tested and certified



Extra-flat threshold

RELIABLE BREAK-IN RESISTANCE EQUIPMENT.

The standard anti-lift kit functions mechanically and thus effectively protects your goods and machines during power outages. **NEW.** You can optionally equip sectional doors, wicket doors and side doors with proven and certified RC 2 security equipment, both in depth 42 and depth 67.

→ For further information, see page 57.

SAFE AND CONVENIENT WORKING. The extra-flat stainless steel threshold rail of wicket doors (Fig. left) facilitates working and reduces the risk of accidents. This reduces the risk of tripping and makes it considerably easier for slide carriages to pass through. Under certain circumstances, wicket doors with trip-free threshold can even be used as escape doors and for barrier-free passages.

→ For further information, see from page 60.

Individual door solutions

These space-saving door systems can be adapted to different building architectures using various track applications. This gives you planning reliability in new buildings or renovations. Hörmann offers tailored solutions: from special doors for logistics companies to underground garage doors all the way to doors integrated in facades with a flush-fitting design.





FULL PASSAGE HEIGHT. NEW. With the right door version and size, the low headroom track application with swivel mechanism can achieve the full door height as the clear passage height with just 200 mm of required headroom. This is especially advantageous in underground garages.

SUITABLE FITTING SOLUTIONS. With more than 30 track applications, industrial sectional doors can be optimally matched to the requirements of your building. Detailed solutions such as low-mounted spring shafts or adjustable components additionally facilitate maintenance and make the doors especially service-friendly.

→ For further information, see from page 58.





24

Logistics
Retailers



26

Warehouses
Agricultural buildings



28

Public buildings
Fire brigades



30

Workshops
Car showrooms



32

Collective garages



34

Prestigious buildings





TOP LEFT. SPU F42 with good thermal insulation for heated buildings

TOP RIGHT. SPU F42 Parcel for loading and unloading lorries and vans at a loading station

BOTTOM LEFT. SPU 67 Thermo in combination with Hörmann loading houses, dock levellers and dock seals for use in food and cold logistics

BOTTOM RIGHT. Low-track sectional door SPU F42 in combination with Hörmann dock levellers and dock seals



LOGISTICS AND CENTRES OF COMMERCE. Hörmann industrial sectional doors and operators are optimally matched to Hörmann loading technology. You therefore receive a logistics solution that perfectly matches your requirements in terms of thermal efficiency and functions. Double-skinned sectional doors SPU F42 / SPU 67 Thermo are recommended for heated buildings to minimise energy losses as far as possible. SPU F42 / APU F42 Parcel was especially developed for parcel services.

→ For further information on SPU F42 / SPU 67 Thermo, see from page 40.

→ For further information on SPU F42 / APU F42 Parcel, see from page 52.

WAREHOUSES AND AGRICULTURAL BUILDINGS. The robust sectional doors are designed for the tough everyday conditions in industrial, commercial and agricultural applications. A wicket door with trip-free threshold provides for easy and safe pedestrian passage, and optional glazings lend the building daylight.

→ For further information about the wicket door with trip-free threshold, see from page 60.





TOP. SPU F42 with wicket door with trip-free threshold for easy pedestrian passage

BOTTOM LEFT. SPU 67 Thermo for large door openings

BOTTOM RIGHT. SPU F42 with ultra-fast door opening of up to 1 m/s with operator WA 500 FU and control 565



PUBLIC BUILDINGS AND FIRE

BRIGADES. Large glazings offer more light in the building and – thanks to Duratec glazing as standard – a permanently clear view. The PU-foamed bottom section of the APU F42 / APU 67 Thermo is cost-effective and resistant to dirt.

→ For further information on APU F42 / APU 67 Thermo, see from page 42.





TOP LEFT. APU 67 Thermo with high thermal insulation and robust bottom section

TOP RIGHT. SPU 67 Thermo with aluminium glazing frame

BOTTOM. ALR F42 with full glazing for more light in the building





TOP. ALR 67 Thermo Glazing with real glass panes

BOTTOM LEFT. APU F42 with matching glazing division for doors with wicket door and doors without wicket door

BOTTOM RIGHT. ALR F42 with full glazing for light in the work area; matching side door NT 60





WORKSHOPS AND CAR

SHOWROOMS. Thanks to large glazings made of real glass, the ALR F42 Glazing becomes a display window, attracting potential customers. The standard Duratec synthetic glazing in the ALR F42 / ALR 67 Thermo ensures a permanently clear view. And a wicket door with trip-free threshold offers service-friendly passage.

→ For further information on ALR F42 Glazing / ALR 67 Thermo Glazing, see from page 46.

→ For further information on ALR F42 / ALR 67 Thermo, see from page 44.





TOP LEFT. ALR F42 with on-site mesh infill

TOP RIGHT. ALR F42 with on-site flush-fitting cladding made of laminated material board

BOTTOM. ALR F42 with expanded mesh infill





COLLECTIVE GARAGES. Especially for this purpose, Hörmann offers perfectly matched systems consisting of door, operator and comprehensive accessory programme, which includes everything from key switch posts to warning light systems.

→ You will find more information on operators and accessories from page 74.

PRESTIGIOUS BUILDINGS. From exclusively glazed doors with an engaging mix of reflection and transparency to flush-fitting facade integration – Hörmann offers the perfect door solution for sophisticated architecture.

→ For further information on ALR F42 Vitraplan and ALR F42 for on-site cladding, see from page 48.





TOP. ALR F42 with on-site flush-fitting cladding made of aluminium compound boards

BOTTOM LEFT. ALR F42 Vitraplan with an engaging mix of reflection and transparency

BOTTOM RIGHT. ALR F42 Vitraplan integrated in glass facade



38



66



74



Versions. Accessories. Technology.

- 38 Section and frame versions
- 40 Double-skinned steel sectional doors
- 42 Glazed aluminium sectional doors with bottom section
- 44 Glazed aluminium sectional doors
- 46 Aluminium sectional doors with extensive glazing
- 48 Aluminium sectional doors with exclusive glazing
- 50 Aluminium sectional doors for on-site cladding
- 52 Logistics doors
- 54 Equipment
- 60 Wicket doors with trip-free threshold
- 64 Side doors
- 66 Individual colour schemes
- 68 Glazings and infills
- 71 ThermoFrame
- 72 Manually operated doors
- 74 Operators and controls
- 100 Technical data

Section and frame versions

Overview



Depth 42 mm

The steel sections **1** and aluminium frame **2** are designed for the tough everyday conditions in industrial and commercial applications and offer good thermal insulation. In case of higher requirements in terms of thermal insulation and maximum transparency, we recommend doors with an aluminium frame with thermal break **3**.

Depth 67 mm

The standard steel sections with thermal break **4** and aluminium frame **5** feature an excellent thermal insulation of up to $0.51 \text{ W}/(\text{m}^2\cdot\text{K})$ in the SPU 67 Thermo and enable door sizes of up to 10 m in width. The thermal break between the exterior and interior also reduces the accumulation of condensation water on the inside of the door.



Matching appearance
In both depths

Both depths can be combined depending on the requirements in the project, as the door view has an entirely matching appearance.

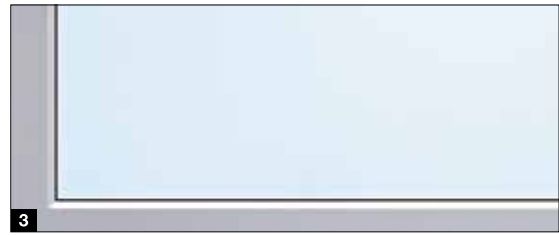

Steel sections

The double-skinned, PU-foamed sections are especially robust, and thanks to a hot-galvanized steel surface with high-adhesion primer coating (2C PUR), they are optimally protected against adverse weather effects. They are used in steel sectional doors and glazed aluminium frame doors with bottom section.

1 The resistant Stucco surface finish offers uniform ribbing every 125 mm in the section and in the section transition. Minor scratches and traces of dirt are harder to notice on this surface finish.

2 The elegant Micrograin surface finish features a smooth surface and characteristic fine line pattern. This surface finish harmonises especially well with modern facades that are characterised by their clear design.

As standard, the inside of the door is Stucco-textured in Grey white, RAL 9002.

Aluminium frame

The aluminium frames are made of high-quality extruded profiles. They are used in glazed aluminium frame doors and as a glazing element in steel sectional doors.

Glazings **3**

The standard double (with 42 mm depth) or triple (with 67 mm depth) Duratec synthetic glazing offers maximum scratch resistance and good thermal insulation. In case of higher thermal insulation requirements, we recommend quadruple glazings or climatic double panes.

Panels **4**

The double-skinned panels are ideal as a robust bottom profile in glazed frame doors.

Mesh infills **5**

For collective garages, expanded meshes or perforated sheet infills provide for optimal ventilation.

→ For further information, see from page 68.

Double-skinned steel sectional doors

SPU F42 / SPU 67 Thermo



Matching appearance
In both depths

- Robust PU-foamed steel sections
- Optionally with Stucco **1** or Micrograin **2** surface finish
- Optional section window or aluminium glazing frame
- Good thermal insulation with SPU F42
- Optimum thermal insulation with SPU 67 Thermo with sections with thermal break



Door type

SPU F42

SPU 67 Thermo

	Without wicket door	With wicket door	Without wicket door	With wicket door
Door size				
Max. width (mm)	8000	7000	10000	7000
Max. height (mm)	7500	7500	7500	7500

Construction

Depth (mm)	42	42	67	67
Steel sections	●	●	●	●
Aluminium frame	○	○	○	○
With thermal break	-	-	●	●

Thermal insulation EN 13241, Appendix B EN 12428

U-value in $W/(m^2 \cdot K)$ for a door surface of 5000×5000 mm

Closed sectional door	1,0	1,2	0,62	0,82
With ThermoFrame	0,94	1,2	0,51	0,75
Section	0,50	0,50	0,33	0,33

- = As standard
- = Optionally as glazing
- = Not available

Example door versions

Door width up to 4500 mm (Example 4500 × 4500 mm)

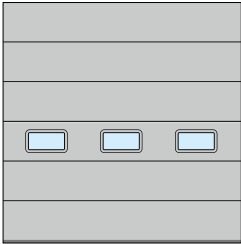

SPU F42
Type E section windows
Uniform field division

Door width up to 5500 mm (Example 5500 × 4500 mm)



SPU F42, SPU 67 Thermo
Type D section windows
Wicket door arrangement on the left

Door width over 5500 mm (Example 7000 × 4500 mm)

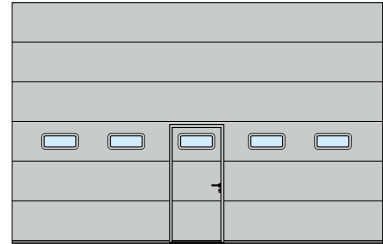

SPU F42, SPU 67 Thermo
Type A section windows
Wicket door arrangement in the centre

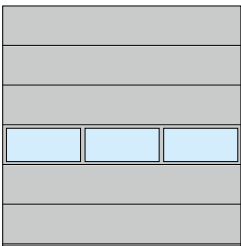

SPU F42, SPU 67 Thermo
Aluminium glazing frame
Uniform field division

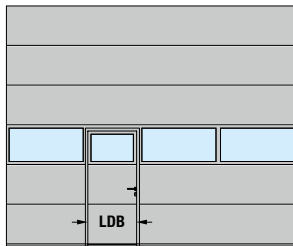

SPU F42, SPU 67 Thermo
Aluminium glazing frame
Wicket door arrangement on the left

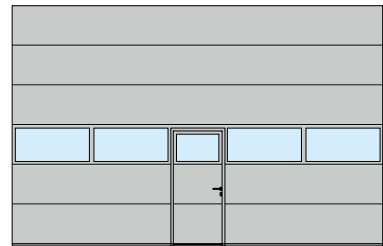

SPU F42, SPU 67 Thermo
Aluminium glazing frame
Wicket door arrangement in the centre

Note

On request, the SPU F42 Plus is available in numerous door styles and surface finishes as with Hörmann sectional garage doors.

Clear passage width (LDB), wicket door
SPU F42: 940 mm
SPU 67 Thermo: 905 mm

Tip

Efficient thermal insulation

With a U-value of up to 0.51 W/(m²·K)

Well-insulated industrial sectional doors are essential in heated buildings to keep energy losses at a minimum. Hörmann industrial sectional doors with 67 mm sections with thermal break offer very effective insulation and thus save energy costs. You can additionally obtain up to 21 % better thermal insulation with the optional ThermoFrame, which thermally separates the frame and brickwork while also sealing the door more effectively with double seals.

→ For further information, see page 71.



Glazed aluminium sectional doors with bottom section

APU F42, APU F42 Thermo, APU 67 Thermo



Matching appearance
In both depths



Duratec
Extremely scratch-resistant

- Extensive aluminium glazing frame
- Robust PU-foamed steel bottom section
- Good thermal insulation with APU F42
- Excellent thermal insulation with APU F42 Thermo with sections with thermal break
- Optimum thermal insulation with APU 67 Thermo with sections with thermal break



Door type	APU F42		APU F42 Thermo		APU 67 Thermo	
	Without wicket door	With wicket door	Without wicket door	With wicket door	Without wicket door	With wicket door
Door size						
Max. width (mm)	8000	7000	7000	7000	10000	7000
Max. height (mm)	7500	7500	7500	7500	7500	7500
Construction						
Depth (mm)	42	42	42	42	67	67
Steel sections	■	■	■	■	■	■
Aluminium frame	●	●	●	●	●	●
With thermal break	-	-	●	●	●	●
Thermal insulation EN 13241, Appendix B EN 12428 U-value in W/(m ² ·K) for a door surface of 5000 × 5000 mm						
Standard double pane	3,4	3,6	2,9	3,1	-	-
With ThermoFrame	3,3	3,6	2,8	3,1	-	-
Standard triple pane	-	-	-	-	2,1	2,3
With ThermoFrame	-	-	-	-	2,0	2,2
Optional climatic double pane, single-pane safety glass	2,5	2,7	2,0	2,2	1,6	1,8
With ThermoFrame	2,4	2,6	1,9	2,1	1,5	1,7

- = As standard
- = As floor section as standard
- = Not available

Example door versions

Door width up to 4500 mm (Example 4500 × 4500 mm)

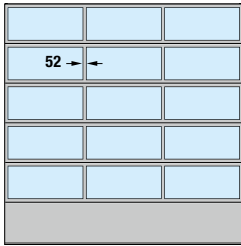

APU F42, APU F42 Thermo,
APU 67 Thermo
Uniform field division

Door width up to 5500 mm (Example 5500 × 4500 mm)

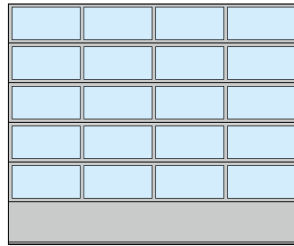

APU F42, APU F42 Thermo,
APU 67 Thermo
Uniform field division

Door width over 5500 mm (Example 7000 × 4500 mm)

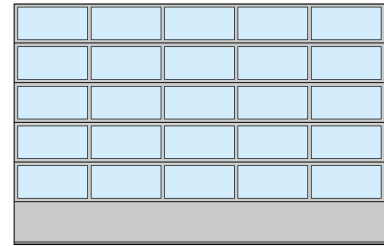

APU F42, APU F42 Thermo,
APU 67 Thermo
Uniform field division

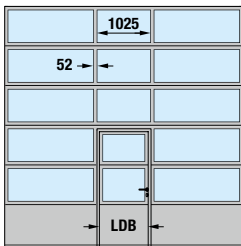

APU F42, APU F42 Thermo,
APU 67 Thermo
Wicket door arrangement in the centre

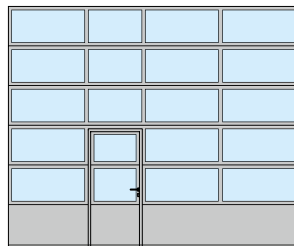

APU F42, APU F42 Thermo,
APU 67 Thermo
Wicket door arrangement on the left

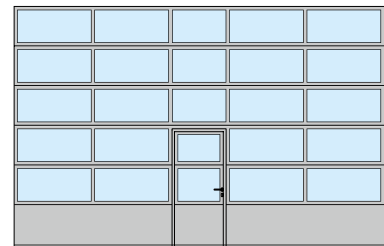

APU F42, APU F42 Thermo,
APU 67 Thermo
Wicket door arrangement in the centre

Note

On request, uniform field division is also possible with wicket door. The field division of the wicket door arrangement is also available for sectional doors without wicket door. For modernisation or when the matching appearance of the existing sectional doors must be ensured, the APU F42 and APU F42 Thermo are also available with 91 mm wide rails.

Clear passage width (LDB), wicket door
APU F42, APU F42 Thermo: 940 mm
APU 67 Thermo: 905 mm

Especially easy to service and repair

Thanks to uniform PU foaming, the 750 mm high bottom section is especially robust, available in either Stucco **1** or Micrograin **2** surface finishes. In case of extensive damage, it can be exchanged easily and inexpensively.

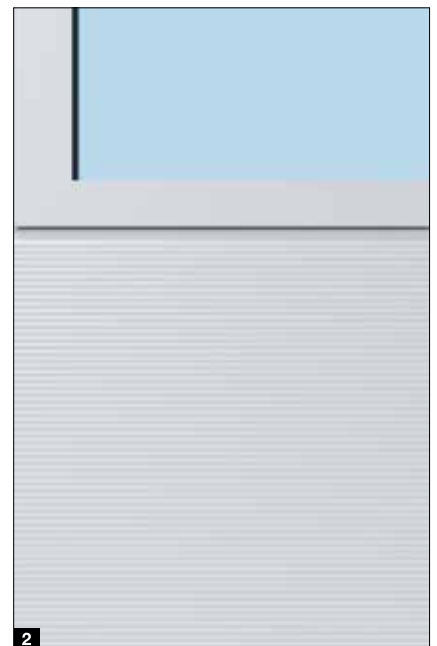
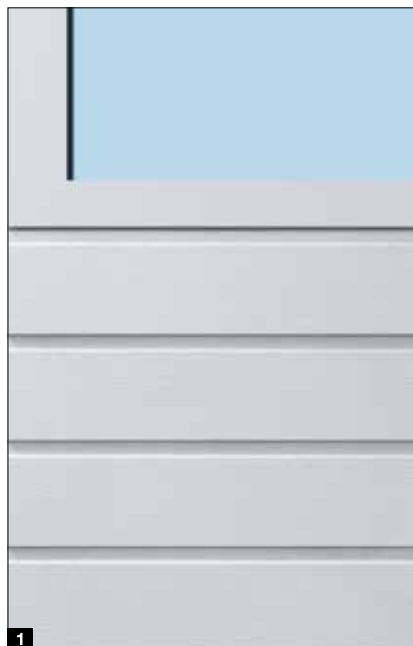

Glazed aluminium sectional doors

ALR F42, ALR F42 Thermo, ALR 67 Thermo



Matching appearance
In both depths



Duratec
Extremely scratch-resistant

- Extensive aluminium glazing frame
- Good thermal insulation with ALR F42
- Excellent thermal insulation with ALR F42 Thermo with sections with thermal break
- Optimum thermal insulation with ALR 67 Thermo with sections with thermal break



Door type	ALR F42		ALR F42 Thermo		ALR 67 Thermo	
	Without wicket door	With wicket door	Without wicket door	With wicket door	Without wicket door	With wicket door
Door size						
Max. width (mm)	8000	7000	7000	7000	10000	7000
Max. height (mm)	7500	7500	7500	7500	7500	7500

Construction

Depth (mm)	42	42	42	42	67	67
Steel sections	-	-	-	-	-	-
Aluminium frame	●	●	●	●	●	●
With thermal break	-	-	●	●	●	●

Thermal insulation EN 13241, Appendix B EN 12428

U-value in W/(m²·K) for a door surface of 5000 × 5000 mm

Standard double pane	3,6	3,8	3,0	3,2	-	-
With ThermoFrame	3,6	3,8	3,0	3,2	-	-
Standard triple pane	-	-	-	-	2,2	2,4
With ThermoFrame	-	-	-	-	2,1	2,3
Optional climatic double pane, single-pane safety glass	2,7	2,9	2,1	2,3	1,7	1,9
With ThermoFrame	2,6	2,8	2,0	2,2	1,6	1,8

- = As standard
- = Not available

Example door versions

Door width up to 4500 mm (Example 4500 × 4500 mm)

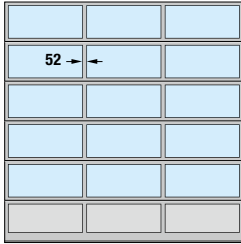

ALR F42, ALR F42 Thermo, ALR 67 Thermo
Uniform field division

Door width up to 5500 mm (Example 5500 × 4500 mm)

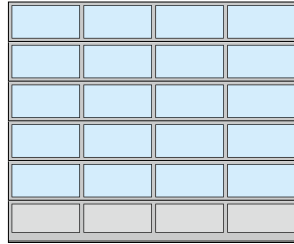

ALR F42, ALR F42 Thermo, ALR 67 Thermo
Uniform field division

Door width over 5500 mm (Example 7000 × 4500 mm)

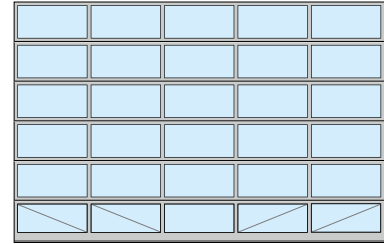

ALR F42, ALR F42 Thermo, ALR 67 Thermo
Uniform field division, full glazing

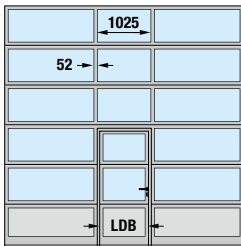

ALR F42, ALR F42 Thermo, ALR 67 Thermo
Wicket door arrangement in the centre

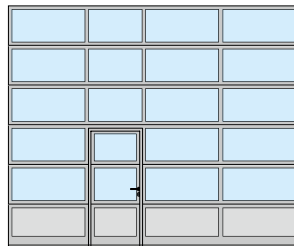

ALR F42, ALR F42 Thermo, ALR 67 Thermo
Wicket door arrangement on the left

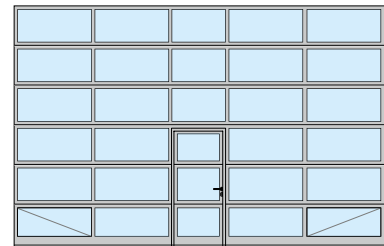

ALR F42, ALR F42 Thermo, ALR 67 Thermo
Wicket door arrangement in the centre,
full glazing

Note

On request, uniform field division is also possible with wicket door. The field division of the wicket door arrangement is also available in doors without wicket door. For modernisation or when the matching appearance of the existing sectional doors must be ensured, the ALR F42 / ALR F42 Thermo is also available with 91 mm wide rails. Of course, individual arrangements of the glass, panel infills and full glazing are possible.

For better stability, the lower window sections on the inside of doors with full glazing (from 5510 mm door width) and doors with real glass and wicket door (from 4510 mm door width) are equipped with diagonal statics cross struts.

Clear passage width (LDB), wicket door
ALR F42, ALR F42 Thermo: 940 mm
ALR 67 Thermo: 905 mm

Optional infills

We deliver the bottom door section as standard with PU sandwich infill, both sides Stucco-textured. Optionally, the door is available fully glazed without surcharge for maximum transparency. Additional glazing variants, sandwich infills and ventilation grilles are available depending on your requirements.

→ For further information, see from page 68.



Aluminium sectional doors with extensive glazing

ALR F42 Glazing, ALR 67 Thermo Glazing



Matching appearance

In both depths



Real glass

- Display window door for an unimpeded view into showrooms
- Continuous window sections, without vertical rails up to 3330 mm door width
- Window sections with exact, uniform division
- Good thermal insulation with ALR F42 Glazing
- Optimum thermal insulation with ALR 67 Thermo with aluminium glazing frame with thermal break



Door type	ALR F42 Glazing	ALR F67 Thermo Glazing
-----------	-----------------	------------------------

Door size

Max. width (mm)	5500	5500
Max. height (mm)	4000	4000

Construction

Depth (mm)	42	67
Steel sections	–	–
Aluminium frame	●	●
With thermal break	–	●

Thermal insulation EN 13241, Appendix B EN 12428

U-value in W/(m²·K) for a door surface of 5000 × 5000 mm

Standard single pane, laminated safety glass	6,1	–
Standard double pane, single-pane safety glass	–	3,0
With ThermoFrame	–	2,9
Optional climatic double pane, single-pane safety glass	2,7	1,8
With ThermoFrame	2,6	1,7

- = As standard
- = Not available

Example door versions

Door width up to 3330 mm
(Example 3300 × 3500 mm)



ALR F42 Glazing, ALR 67 Thermo Glazing

Door width over 3330 mm
(Example 4500 × 3500 mm)

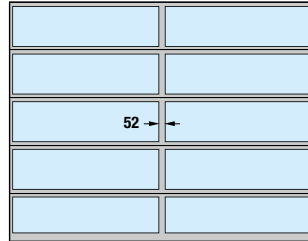

ALR F42 Glazing, ALR 67 Thermo Glazing
with vertical rail

Note

For modernisation or when the matching appearance of the existing sectional doors must be ensured, the ALR F42 Glazing is also available with 91 mm wide rails.

Tip

Efficient thermal insulation

With a U-value of up to 1.7 W/(m²·K)

Heated sales areas

The ALR 67 Thermo Glazing has a thermal break and offers optimal thermal insulation with maximum transparency.

An optional climatic glazing and ThermoFrame decrease the thermal insulation value to a maximum of 1.7 W/(m²·K). This helps you save valuable energy.

→ For further information, see from page 68.



Aluminium sectional doors with exclusive glazing

ALR F42 Vitraplan



Duratec

Extremely scratch-resistant

- Engaging mix of reflection and transparency
- Surface-mounted flush-fitting glazing in grey or brown
- Frame profiles with matching colours



Door type

ALR F42 Vitraplan

Door size

Max. width (mm)

6000

Max. height (mm)

7500

Construction

Depth (mm)

42

Steel sections

–

Aluminium frame

●

With thermal break

–

Thermal insulation EN 13241, Appendix B EN 12428

U-value in W/(m²·K) for a door surface of 5000 × 5000 mm

Standard double pane

3,2

With ThermoFrame

3,2

Optional triple pane

3,1

With ThermoFrame

3,1

● = As standard

– = Not available

Example door versions

Door width up to 4500 mm
(Example 4500 × 4500 mm)

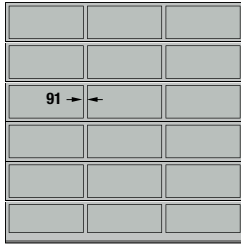

ALR F42 Vitraplan
Uniform field division

Door width over 4500 mm
(Example 5500 × 4500 mm)

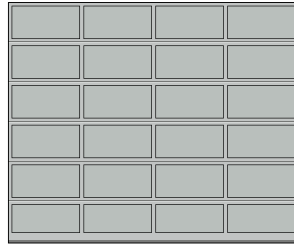

ALR F42 Vitraplan
Uniform field division

For sophisticated architecture

The ALR F42 Vitraplan is especially elegant thanks to offset, flush-fitting glazing. The frame profile is concealed, so nothing detracts from the clear overall appearance. Continuous glazing adds an eye-catching element to modern industrial structures and prestigious private buildings.



Aluminium sectional doors for on-site cladding

ALR F42

- Frame profiles with PU sandwich infill
- With horizontal profiles for cladding fitting
- For flush-fitting cladding made of timber, metal and many other materials



ALR F42

The facade cladding door base consists of frame profiles with PU sandwich infill. The horizontal profiles are cladded. Optionally, we provide vertical fitting profiles to which the facade material can be attached simply and unseen. You can design the on-site, flush-fitting facade cladding according to your wishes with timber, metal, ceramics, plastic and many other materials. Please observe the maximum weight per unit area of the on-site cladding.

→ For more information, refer to the planning aids.



Flush-fitting facade door



Flush-fitting facade door with base construction

Door type	ALR F42	
Door size	Depending on the weight of the on-site cladding	
Max. width (mm)	7000	
Max. height (mm)	4500	
Construction		
Depth (mm)	42	
Steel sections	-	
Aluminium frame	●	
With thermal break	-	
Thermal insulation EN 13241, Appendix B EN 12428	U-value in W/(m ² ·K) for a door surface of 5000 × 5000 mm	
PU sandwich infill	2,6	

● = As standard
 - = Not available

Excerpt from the planning aid

Standard fitting in the opening

Standard version

- Horizontal view – door frame connection to the facade wall **1**
- Vertical view of the section transitions **2**

Version with fitting profiles

- Horizontal view – door frame connection to the facade wall **3**
- Vertical view of the section transitions **4**

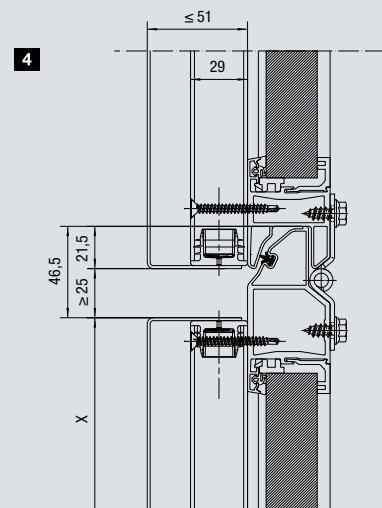
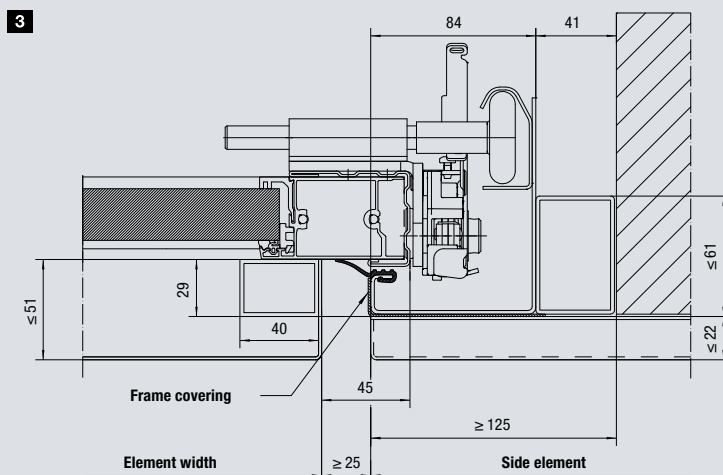
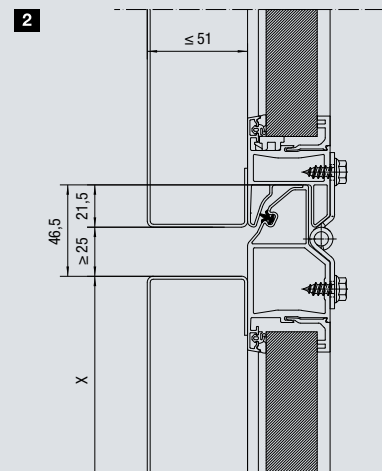
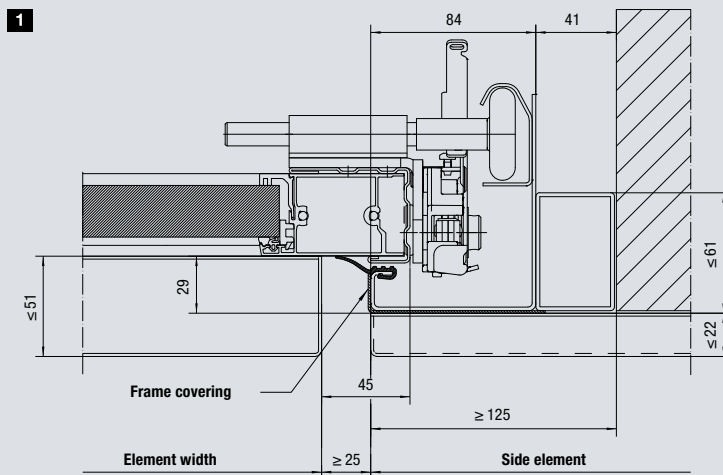

Logistics doors

SPU F42 Parcel / APU F42 Parcel

- Robust PU-foamed steel sections with good thermal insulation in SPU F42 Parcel
- Combinations of extensive aluminium glazing frame and robust PU-foamed steel bottom sections in APU F42 Parcel



Door type	SPU F42 Parcel	APU F42 Parcel
Door size incl. bottom section		
Width LZ (mm)	1500 – 3000	1500 – 3000
Height RM (mm)	3125 – 4250	3125 – 4250
Bottom section height SLH (mm)	500 – 1450	500 – 1450
Opening height (mm)	2575 – 3700	2575 – 3700
Construction		
Depth (mm)	42	42
Steel sections	●	■
Aluminium frame	○	●
With thermal break	–	–
Closed sectional door	1,0	–
Standard double pane	–	3,4
Track application versions	HP track application, VP track application	
Door operation	Operator WA 300 S4 (press-and-hold control) and push button DTH-R	
Options	Shootbolt for use as night door rotary latch	

- = As standard
- = Bottom floor section
- = Optional glazing element
- = Not available

SPU F42 Parcel / APU F42 Parcel

Divisible industrial doors

In parcel service logistics centres or warehouses, different loading sites were previously required to load and unload lorries or swap containers and transit vans. The loading floor heights for vans are, at 55 cm, much lower than those for lorries and swap containers, which are approx. 1.35 m.

With the industrial door Parcel, both types of vehicles can be loaded and unloaded at one loading site. For loading lorries or swap containers, the bottom section is disconnected from the door and only the top part of the door is opened **1**. To load vans, the bottom section (SLH) is coupled with the door and remains in the top part of the opening when the door is open **2**.

Advantages through the dual use of the loading site:

- Reduced costs for e.g. Conveyor belts, loading sites
- Lower manpower costs due to fewer loading sites
- More efficient loading site utilisation through dual use

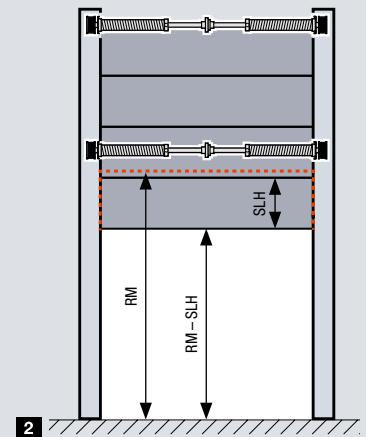
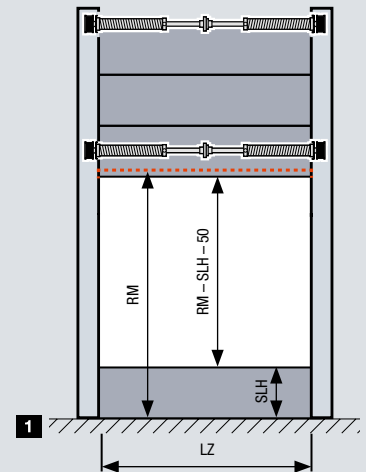

Variable door opening

Both door segments are counterbalanced by separate springs and can therefore be moved separately. The power limit of the WA 300 S4 effectively protects against damage from possible obstructions.



Safe and convenient operation

The door is operated using a DTH-R push button (press-and-hold operation). Glazing in the door enables looking outside.



Easy decoupling

Releasing the espagnolette lock decouples the lower segment.

Innovative construction

For long-lasting door function





Only from Hörmann

- **NEW. ONLY FROM HÖRMANN.** Large track radii **1** for quiet, low-wear door travel
- **NEW. ONLY FROM HÖRMANN.** Twin rollers **2** on the top section for especially quiet door closing
- Adjustable plastic rollers with ball-bearing for precise door travel
- **NEW.** Optional 2-component rollers to reduce travel noises by up to 5 dB(A) **3**
- **NEW. ONLY FROM HÖRMANN.** Optional plastic frame shoe **4** prevents rust as a result of waterlogging on the door frame
- Upper frame end with connecting bracket **5** for easy fitting of the entire spring shaft
- Secure connection as one piece from the spring shaft to the cable drum **6** for reliable functioning
- Optimised centre hinges made of galvanized steel **7** to connect the individual door sections
- Fitting-friendly roller brackets **8** and roller holders on robust end caps ensure reliable connection of the rollers to the track.

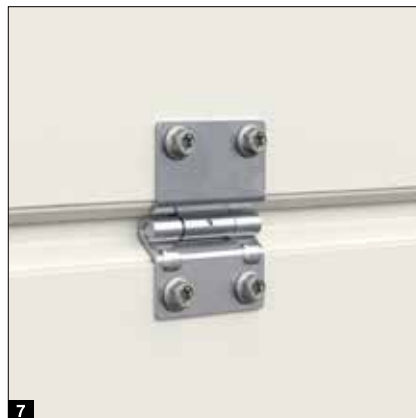

Certified safety

For secure door function



Tested and certified

Hörmann industrial sectional doors comply with the safety requirements of European standard 13241. Have this confirmed by other manufacturers!

- Secure door guide prevents the rollers from jumping out of the track **1**
- Easy door opening and closing thanks to optimal counterbalance
- Catch safety device **2** (depending on equipment) provides protection in case a cable or spring breaks. **EUROPEAN PATENT**
- Spring safety device (depending on equipment) stops the torsion spring shaft if a spring breaks and securely holds the door in position. **EUROPEAN PATENT**
- Finger trap protection on doors with a depth of 42 mm eliminates trap points on the inside and outside
- Internally guided cables prevent trapping on the cable **3**
- Side trap guard thanks to side frames closed completely from top to bottom
- Closing edge safety device in operators WA 400 / ITO 400, WA 500 FU / ITO 500 FU as well as automatic safety cut-out in operators WA 300 S4 and SupraMatic HT stop the door in the event of danger



Reliable security equipment

For protecting goods and machines



Only from Hörmann
Anti-lift kit on both sides



Anti-lift kit as standard



Optional RC 2 safety equipment
Tested and certified

Anti-lift kit as standard

It is also important for industrial doors to be reliably break-in-resistant to protect your goods and machines.

At Hörmann, all industrial sectional doors are delivered with a break-in-resistant anti-lift kit on both sides as standard. This mechanical protection reliably prevents the door from being forcefully pushed open, even in case of a power failure. In sectional doors with rail-guided operators, self-locking gearboxes ITO 400 / ITO 500 FU or patented door locking in the operator boom (SupraMatic HT) protect against forced opening.

Optional RC 2 security equipment

For especially high break-in resistance, industrial sectional doors SPU F42 and SPU 67 Thermo are optionally available in resistance class RC 2 – tested and certified in accordance with the new standard DIN / TS 18194. This certified security is also recommended by police information centres. Further information can be found at www.k-einbruch.de



The locking hook of the anti-lift kit automatically latches if the door is forced upwards.

Fitting advantages

For simple, precise fitting

- **NEW.** Precisely fitting connection of track and radius through transition sleeves **1**
- **NEW.** Faster fitting thanks to fewer components and press-fitted screws **2**
- **NEW.** Ceiling anchor with perforation in two rows for simple fitting
- **NEW.** Suspension material easy to fit as L-bracket
- **NEW.** Fewer suspension points with optional C-rail **3**
- **NEW.** Recess at the frame shoe **4** facilitates work if the floor is not yet finished
- Flexible shaft coupling to compensate for minor deviations in alignment
- Screwed-on tracks for simple, cost-effective exchange in the event of collision damage in the frame area



Only from Hörmann

Low headroom track application

Operator and chain are directly on the door.

An unsightly and potentially hazardous chain no longer dangles down. It pays to compare!

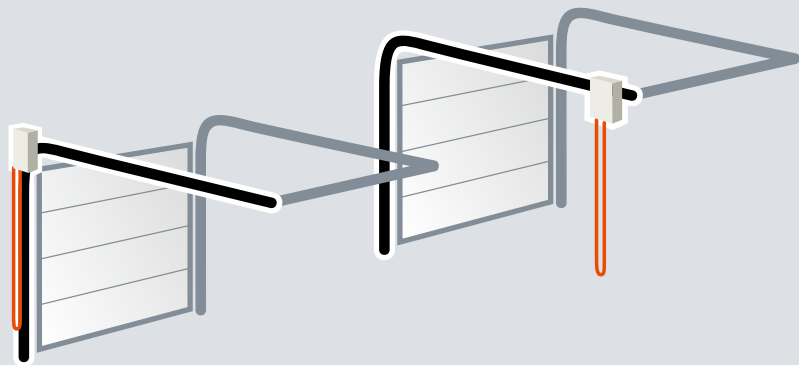

Hörmann's optimal arrangement

Competitors' disruptive arrangement

Track versions

Sound planning for old and new buildings

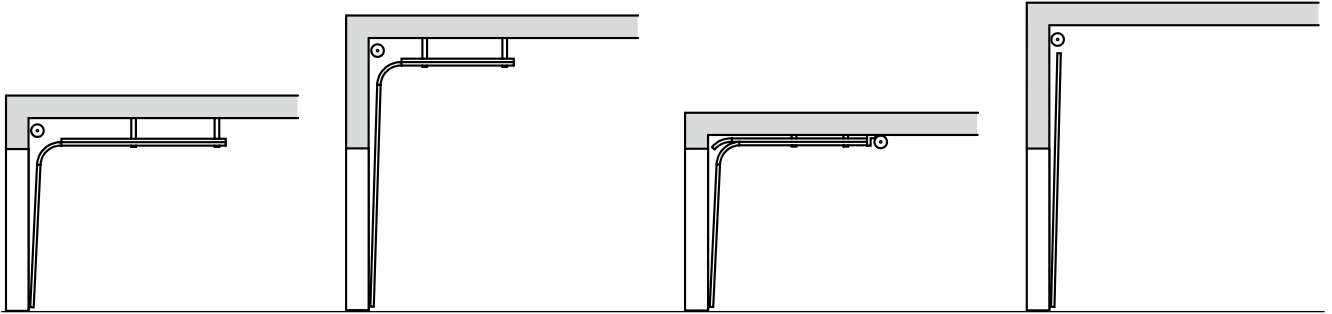

Track application N
Normal track application

Track application H
High-lift track application

Track application L
Low headroom track application

Track application V
Vertical track application

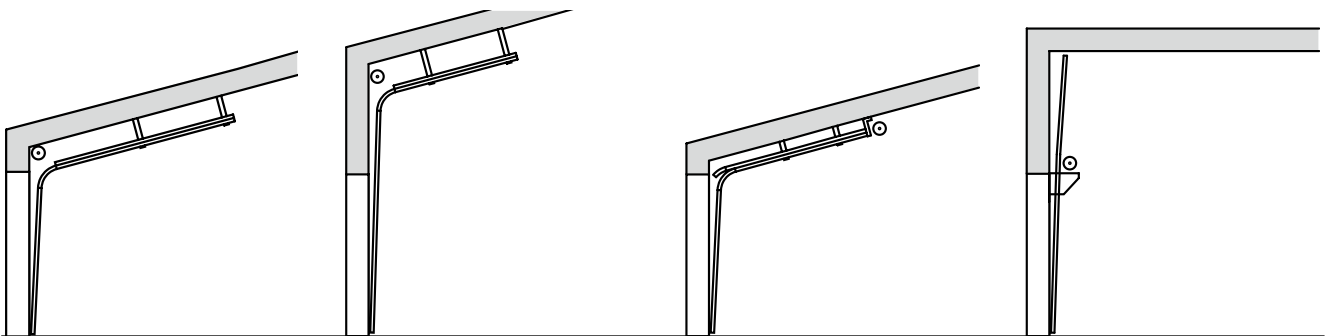

Track application ND
With inclination

Track application HD
With inclination

Track application LD
With inclination

Track application VU
With low-mounted spring shaft



For more information,
consult the technical manual.

Only from Hörmann

Full passage height

NEW. Under certain circumstances, the low headroom track application enables the full passage height with only 200 mm required headroom.

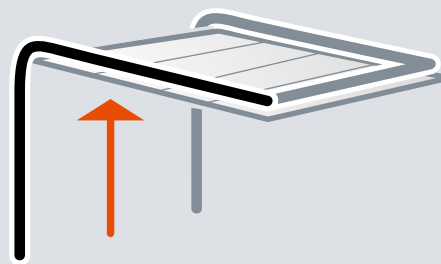

Wicket doors with trip-free threshold

with high-quality equipment





Overhead door closer

As standard, wicket doors are supplied with slide rail door closer including hold-open device **1**.

An integrated door closer with hold-open device **2** is optionally available for doors with 42 mm depth for optimum protection and the best appearance.



Optional multiple-point locking **3**

The wicket door is locked over the entire door height with one bolt and hook bolt per door section. The advantage: better stability and improved break-in resistance.

Robust door catch **4**

The robust door catch prevents door leaf dropping and warping.



Flat wicket door frame **5**

The all-round frame consists of a flat aluminium profile. This way, the wicket door is harmoniously integrated into the door.



Concealed hinges **6**

For a uniform door view, the wicket doors are equipped with concealed hinges as standard.



Finger trap protection (outside and inside)* **7**

The unique shape of the door sections and the wicket door frame eliminate trap points during door opening and closing.



Optimally sealed **8**

The adjustable threshold profile with flexible seal compensates for unevenness in the floor. Adjustable double seals located in the transitions from the bottom edge of the door to the floor and from the door leaf to the threshold rail optimally seal the bottom edge of the door and the wicket door opening.



* Not for wicket door with 67 mm depth

Wicket doors with trip-free threshold

Full-fledged passage doors

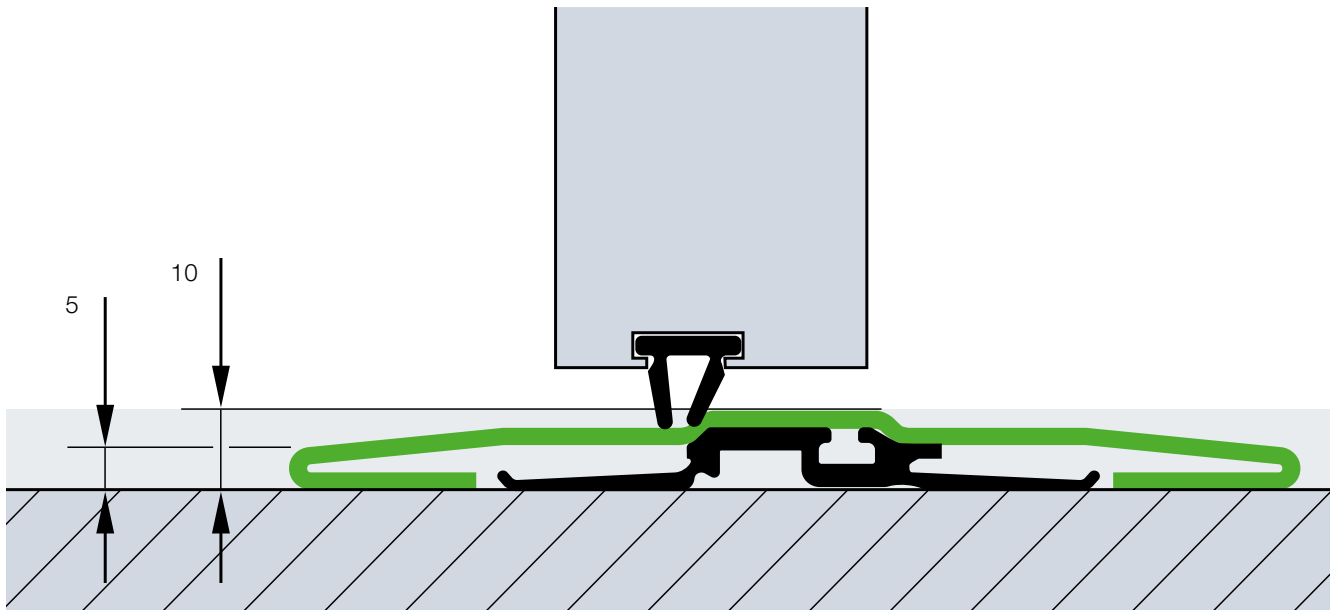

Wicket door construction for sectional doors with 42 mm depth

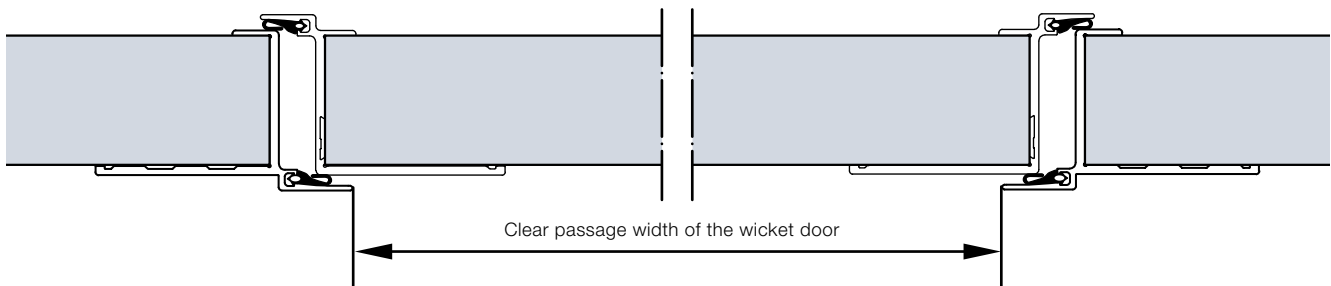

Wicket door construction with thermal break for sectional doors with 67 mm depth

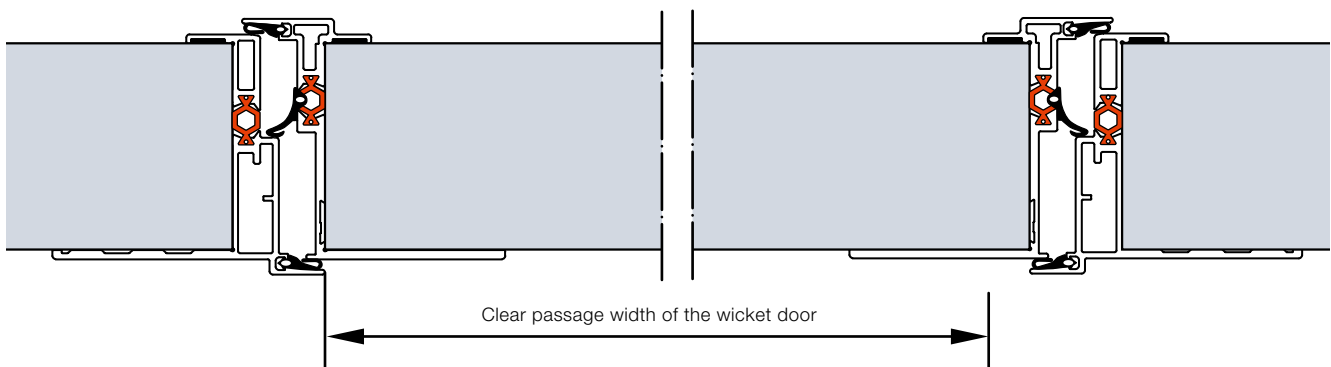

Trip-free passage

The stainless steel threshold rail is 10 mm high at the centre and 5 mm at the edges. We provide a reinforced threshold rail of approx. 13 mm for doors from 5510 mm width or for doors / wicket doors with real glass from 4510 mm width.

940 / 905 mm clear passage width as standard

Under certain circumstances, the wicket door with trip-free threshold, with its clear passage width of 940 mm (depth 42 mm) or 905 mm (depth 67 mm), fulfils the requirements for an escape door and for barrier-free construction.

Freely selectable position

The wicket door can be positioned to the left, right or at the centre (except for the two outer fields). The window sections above the wicket door have a clear view of 1025 mm as standard. All other sections of the door have identical widths.

Example door versions

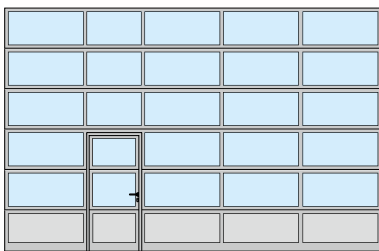

Wicket door arrangement on the left

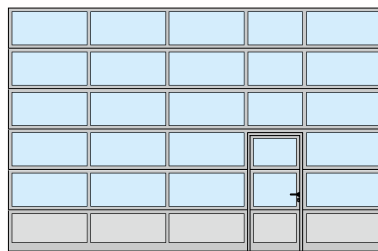

Wicket door on the right



Wicket door in the centre

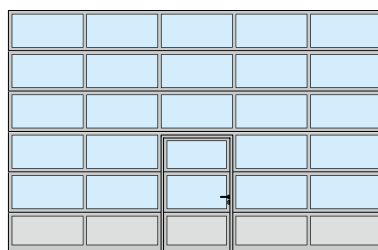

Wicket door in the centre with uniform field division



Escape door

Under certain circumstances, Hörmann doors with wicket door and trip-free threshold fulfil the requirements of an escape door (for doors up to 5500 mm width or for doors with real glass up to 4510 mm width).



Barrier-free entrance

Under certain conditions, Hörmann sectional doors with wicket door and trip-free threshold fulfil the requirements for accessibility in accordance with DIN EN 18040-1 and are certified by the ift Rosenheim.

Note

On request, doors with wicket door are also available with uniform field division and the wicket doors can be supplied in individual sizes or matching existing doors, even with threshold rails. We recommend the wicket door with threshold rail for inclining surfaces in the opening area.

Side doors

Matching the door

Side door NT 60 **1**

- 60 mm aluminium frame construction
- As standard with all-round seals made of long-lasting, weather-resistant EPDM
- Infill variants same as for sectional doors with 42 mm depth
- Infill fixed by glazing beads

- 1** Viewed from outside
- 2** Viewed from inside with synthetic glazing
- 3** Viewed from inside with sections
- 4** Lever handle set as standard



Side door with thermal break

NT 80 Thermo **5**

- 80 mm aluminium frame construction with thermal break
- As standard with all-round seals made of long-lasting, weather-resistant EPDM
- Infill variants with thermal break same as for doors with 42 mm and 67 mm depth
- Infill fixed by glazing beads

- 5** Viewed from outside
- 6** Viewed from inside with triple synthetic glazing
- 7** Lever handle set as standard
- 8** Thermal break between door leaf, frame and threshold



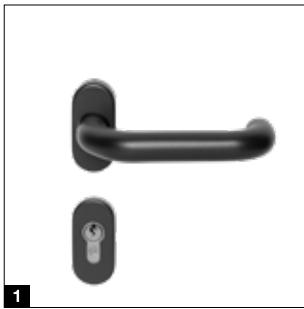

Fittings

- Mortice lock with profile cylinder
- Offset lever handle set with oval rose escutcheons, made of black plastic **1**
- On request also available as lever / knob handle sets
- Optionally available in natural finish cast aluminium **2**, polished stainless steel **3** or brushed stainless steel **4**

Optional equipment

- Tested break-in-resistant RC 2 security equipment according to DIN EN 1627
- Stainless steel push bar 38-2, brushed, 1000 mm high, exterior, additionally with stainless steel lever handle set, interior
- Overhead door closer with hold-open device
- Push bar for escape door, inside (anti-panic lock required)
- Multiple-point locking also with anti-panic functions B, D, E

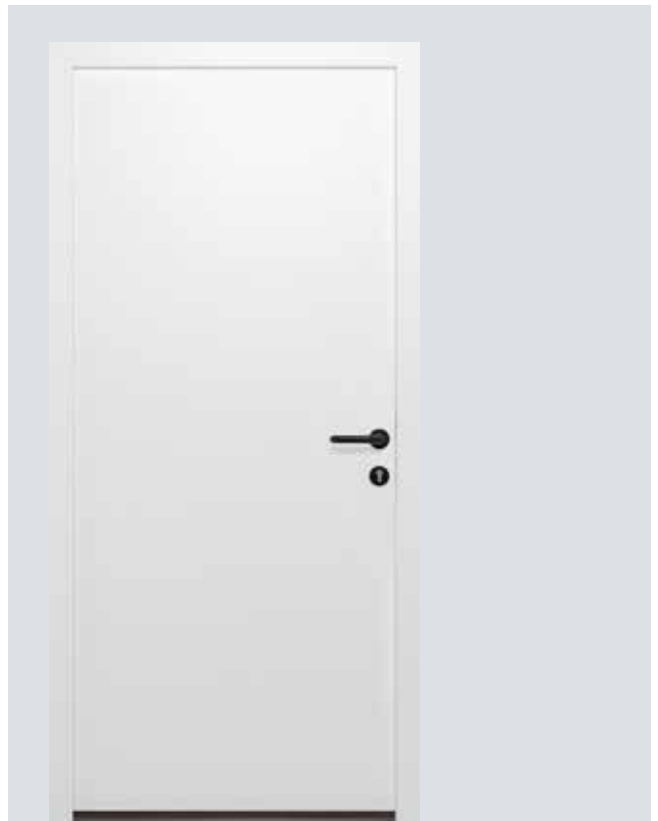

MZ Thermo65 multi-purpose door

Steel side doors with thermal break

- 65 mm thick door leaf with thermal break and PU rigid foam infill
- Aluminium block frame with thermal break and threshold with thermal break
- High thermal insulation with a U-value = 0.82 W/(m²·K)
- Optionally available in an RC 2 version as KSI Thermo46 with 46 mm thick door leaf



For further information, see the "Steel doors" brochure.

Individual colour schemes

For greater design freedom

High-quality primer coating

- 11 preferred colours as well as RAL and NCS, in many metallic colours as well as acc. to British Standard ¹⁾
- Coil coating procedure for double-skinned sections in preferred colours, Grey white RAL 9002 on the inside
- 2C-PUR coating on the outside or outside and inside for all other colours
- Door leaf reinforcements and end caps in Grey white, RAL 9002, as standard

Optional colour coating

- Wicket door frame profiles in anodised aluminium E6 / C0 on the outside, inside
- Leaf frame and door frame of side doors
- Aluminium glazing frame and glazing beads
- External frame of compound glazings type A (die-cast frame) and type D (plastic frame), internal frame black as standard

Preferred colours

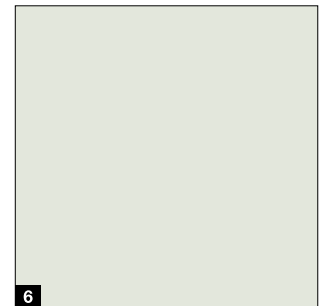
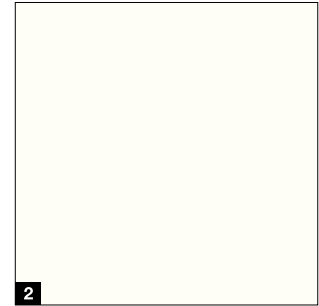
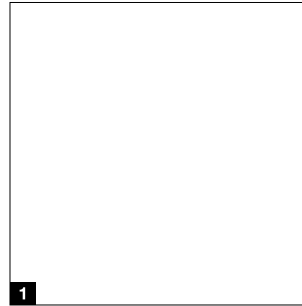

Note

Dark colours should not be used for double-skinned steel doors and for doors with thermal break that are exposed to the sun, as possible section deflection may restrict the door's function (bi-metal effect). The colours shown are subject to the limitations of the printing process and cannot be regarded as binding. Contact your Hörmann specialist dealer for advice regarding coloured doors. All colours based on RAL.

¹⁾ With the exception of pearl-effect and fluorescent colours, slight colour variations are permissible.

²⁾ Except for ALR F42 Vitraplan

Doors with double-skinned steel sections in the preferred colours are supplied in Grey white, RAL 9002, on the inside **1**. The frames for compound glazing are black as standard on the interior of the door.

Door leaf reinforcements and the end caps of the door sections on the inside of coloured doors are supplied in Grey white, RAL 9002, as standard ²⁾. For doors with wicket door, the frame of the wicket door on the inside consists of aluminium profiles in E6 / C0 **2**.

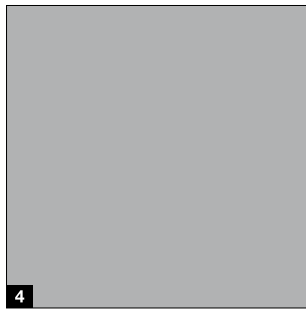
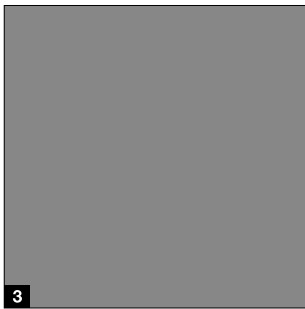

At no surcharge

Preferred colours for double-skinned steel sections in all depths

- 1 RAL 9016 Traffic white
- 2 RAL 9010 Pure white
- 3 RAL 9007 Grey aluminium
- 4 RAL 9006 White aluminium
- 5 RAL 9005 Jet black. **NEW**
- 6 RAL 9002 Grey white
- 7 RAL 8028 Terra brown
- 8 RAL 7016 Anthracite grey
- 9 RAL 6005 Moss green
- 10 RAL 5010 Gentian blue
- 11 RAL 3000 Flame red



Glazings and infills

For more light and better ventilation

● = Possible

	Duratec glazing	SPU F42	SPU 67 Thermo	APU F42	APU F42 Thermo	APU 67 Thermo	ALR F42	ALR F42 Thermo	ALR 67 Thermo	ALR F42 Glazing	ALR 67 Thermo Glazing	ALR F42 Vitraplan
Aluminium glazing frame												
Synthetic panes												
Clear single pane	●	●		●			●					
Single pane, crystal structure		●		●			●					
Clear double pane	●	●		●	●		●	●				●
Double pane, crystal structure		●		●	●		●	●				●
Double pane, tinted brown, grey or white (opal)	●	●		●	●		●	●				
Clear triple pane	●	●	●	●	●	●	●	●	●			●
Triple pane, crystal structure		●	●	●	●	●	●	●	●			●
Triple pane, tinted in brown, grey or white (opal)	●	●	●	●	●	●	●	●	●			
Clear quadruple pane	●		●			●			●			
Quadruple pane, crystal structure			●			●			●			
Quadruple pane, tinted in brown, grey or white (opal)	●		●			●			●			
Polycarbonate panes												
Clear single pane	●	●		●			●					
Clear double pane	●	●		●	●		●	●				●
Real glass panes												
Clear single pane made of laminated safety glass		●		●			●			●		
Clear double pane made of single pane safety glass		●	●	●	●	●	●	●	●	●	●	
Clear climatic double pane made of single pane safety glass		●	●	●	●	●	●	●	●	●	●	
Infills												
Multiple-moulded pane		●		●	●		●	●				
Expanded mesh, stainless steel ventilation cross-section: 58 % of the infill surface		●		●			●					
Perforated steel sheet, stainless steel ventilation cross-section: 40 % of the infill surface		●		●			●					
PU infill aluminium sheet cladding, anodised on both sides, smooth				●	●	●	●	●	●			
PU infill, aluminium sheet cladding, Stucco-textured on both sides				●	●	●	●	●	●			

A permanently clear view

The Duratec glazing is available as standard and at no surcharge for all sectional doors with clear synthetic glazing.

With Duratec synthetic glazing, Hörmann sectional doors retain their clear view permanently, even after multiple cleanings and heavy use, unlike with standard synthetic glazings.

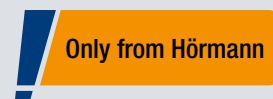

Duratec
Extremely scratch-resistant

Aluminium glazing frame

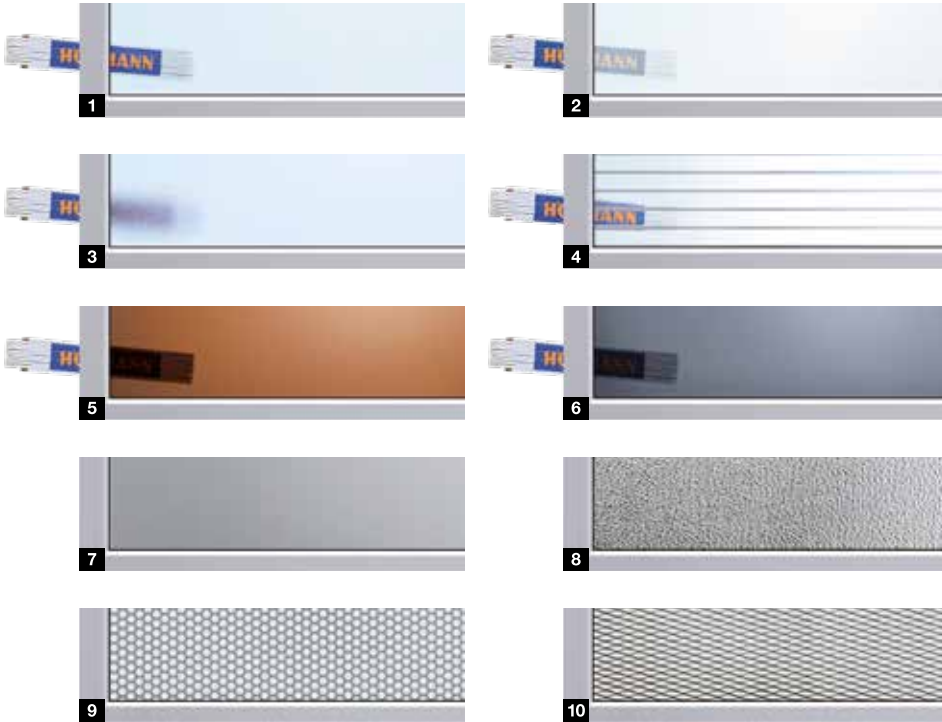
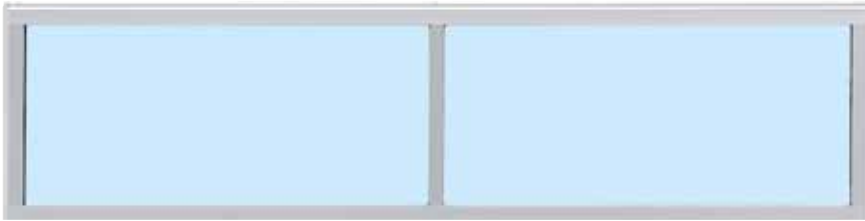

- | | |
|--|---|
| <p>1 Polycarbonate double pane, clear
Synthetic double pane, clear</p> <p>3 Synthetic double pane, crystal structure</p> <p>5 Synthetic double pane, brown tinted</p> <p>7 PU sandwich infill, smooth</p> <p>9 Perforated stainless steel sheet</p> | <p>2 Synthetic double pane, white tinted (opal / clear)</p> <p>4 Multiple-moulded pane</p> <p>6 Synthetic double pane, grey tinted</p> <p>8 PU sandwich infill, Stucco</p> <p>10 Stainless steel expanded mesh</p> |
|--|---|

Aluminium glazing frame

Thermal break	Without	With
Standard	Anodised in natural finish E6 / C0	Anodised in natural finish E6 / C0
Optional	Colour coating on the interior and exterior	Colour coating on the interior and exterior
Clear view	Depending on version	Depending on version
Rail extrusion	52 mm, optionally 91 mm*	52 mm, optionally 91 mm*

* Only 42 mm depth

Excellent thermal insulation as standard

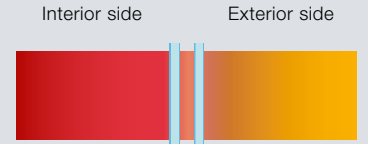

Conventional double pane, 16 mm from other manufacturers



Up to 20 % improved thermal insulation*
DURATEC double pane, 26 mm (as standard)



Up to 35 % improved thermal insulation*
DURATEC triple pane, 26 mm (optional)



Up to 40 % improved thermal insulation*
DURATEC triple pane, 51 mm (optional),

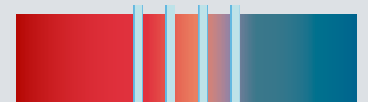

Up to 55 % improved thermal insulation*
DURATEC quadruple pane, 51 mm (optional),



Up to 65 % improved thermal insulation*
Climatic double pane, 26 mm (optional),

* Compared with customary 16 mm double panes of other manufacturers

Glazings

For more light

	Duratec glazing	SPU F42	SPU 67 Thermo
--	-----------------	---------	---------------

● = Possible

Compound glazings

Synthetic panes

Clear double pane, synthetic frame	●	A, D, E
Clear double pane, die-cast frame	●	A
Clear triple pane, synthetic frame	●	D
Clear triple pane, die-cast frame	●	A
Clear quadruple pane, die-cast frame	●	A

Polycarbonate panes

Clear double pane, die-cast frame	●	A
-----------------------------------	---	---

Real glass panes

Clear double pane made of single pane safety glass		A
Clear triple pane single-pane safety glass		A

Compound glazings



- 1 Compound glazings type A
- 2 Compound glazings type D
- 3 Compound glazings type E

Compound glazings

	Type A	Type D	Type E
Standard	Plastic or die-cast frame in black	Black plastic frame	Black plastic frame
Optional	Die-cast frame with colour coating on the exterior	Colour coating on the exterior	
Clear view	602 × 132 mm	602 × 132 mm	725 × 370 mm
Rail extrusion			
Door section height	500, 625, 750 mm	500, 625, 750 mm	625, 750 mm

A permanently clear view

The Duratec glazing is available as standard and at no surcharge for all sectional doors with clear synthetic glazing.

With Duratec synthetic glazing, Hörmann sectional doors retain their clear view permanently, even after multiple cleanings and heavy use, unlike with standard synthetic glazings.



Duratec
Extremely scratch-resistant

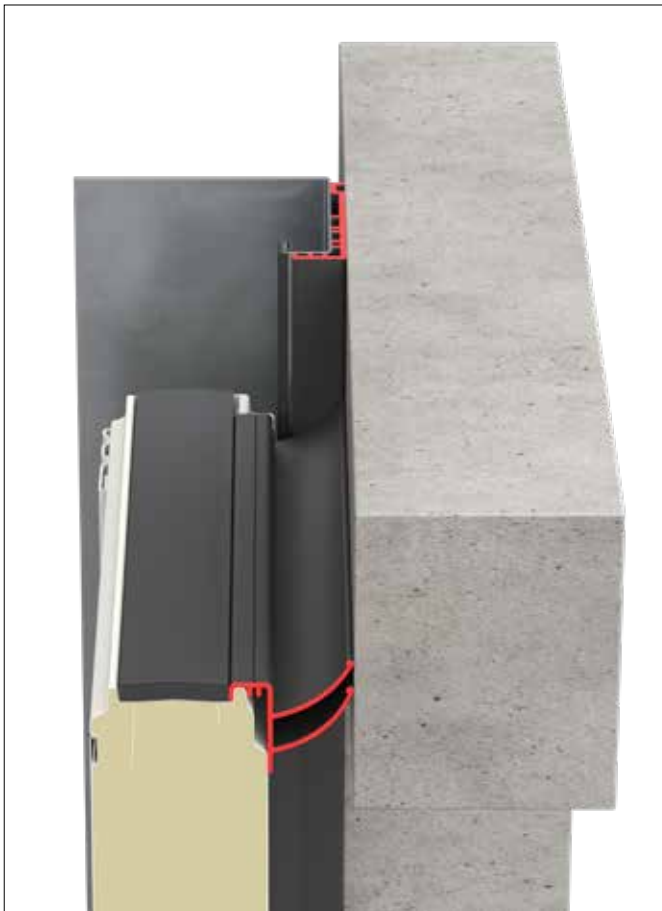

Up to 21 %
Improved thermal insulation

Advantages at a glance:

- Thermal break between the frame and brickwork
- Additional seals for improved tightness
- Easy to fit together with the door frame
- Optimum corrosion protection of the side frame
- **Up to 21 % improved thermal insulation***

* With the industrial sectional door SPU 67 Thermo, for a door surface of 3000 × 3000 mm

SPU F42 Door surface (mm)	Without ThermoFrame	With ThermoFrame	Improvement
	W/(m ² ·K)	W/(m ² ·K)	
3000 × 3000	1,22	1,07	12,3
4000 × 4000	1,10	0,99	10,0
5000 × 5000	1,03	0,94	8,7
SPU 67 Thermo Door surface (mm)			
3000 × 3000	0,81	0,64	21,0
4000 × 4000	0,69	0,56	18,8
5000 × 5000	0,62	0,51	17,7

Manually operated doors

As standard with pull rope or pull rod

Securely locked as standard

Shootbolt

NEW. With adjustable lock plate

This can be secured with an on-site padlock as a secure night lock.



Rotary latch

NEW. With locking bolts that can be adjusted horizontally and vertically

This door lock automatically locks itself through the latching disc.

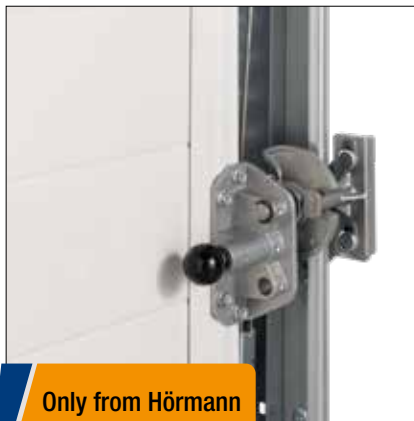

Only from Hörmann

Floor locking

This enables frequently used doors to be released by foot. The automatic latch audibly engages when closed.



Only from Hörmann

European patent

Optional operation options

Hand pulley

With rope or link steel chain

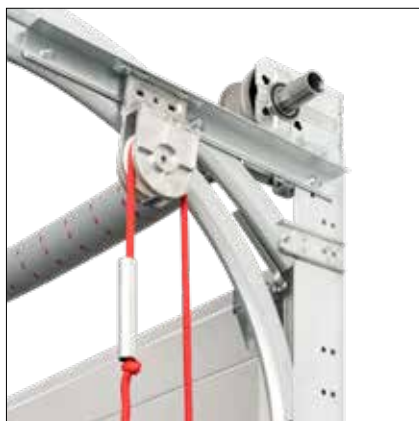

Chain hoist



Chain tensioner

For easier operation



Lock operation from outside

Handle set

With the handle set, the door lock can be ergonomically operated from outside. From inside, the lock is operated via T-handle and securing split pin.

The profile cylinder can also be integrated into central locking systems.

Recessed handle set

Thanks to a flat design and flexible installation height, the handle set is ideal for loading ramp doors in logistics applications. You can operate two functions with the locking cylinder: permanently unlocked door and automatic re-locking.

All parts on the inside are protected by cladding.



Shootbolt



Rotary latch



Shootbolt



Rotary latch



WA 300 S4

230 volt 1-phase current

- Soft start and soft stop for gentle door travel
- Power limit in “Open” / “Close” directions
- Max. opening speed 19 cm/s
- Max. 150 door cycles per day
- Max. 10 door cycles per hour
- Integrated control with push button DTH-R
- Optional external control 360 (prepared for traffic control)
- Small side room of only 200 mm
- No installations or cabling required on the door leaf ¹⁾
- Standby approx. 1 W ²⁾
- Max. door width 6000 mm
- Max. door height 4500 mm

¹⁾ Except for doors with wicket door

²⁾ If no other electrical accessories are connected

Fitting versions

Diagonal **1**

Vertical **2**

Safe “Close” door travel with reduced speed

All “Open” door travel as well as “Close” door travel above a 2500 mm opening height takes place at a speed of approx. 19 cm/s. With an opening height below 2500 mm, “Close” door travel must be set to approx. 10 cm/s for safety reasons. This restriction does not apply to optional leading photocells or closing edge safety devices, meaning the door opens and closes at approx. 19 cm/s.



Watch the video at
www.hoermann.com/videos



Maintenance release directly on the operator

During the statutory annual door inspection, it is not necessary for the operator to be removed from the door shaft. This saves you time and money. The maintenance release can be converted to a secured release at any time.



Combination control 420Si / 420Ti for operator and dock leveller

This easy-to-fit solution combines door operation with a standard dock leveller control in a housing. The control housing is prepared for retrofitting, e.g. with option relay HOR1-300 for Open limit switch reporting for dock leveller release. Optionally available for operator WA 300 S4 with integrated control.



Battery HNA-300

With this emergency power supply in an external housing, you can bypass network power failures for up to 18 hours and max. 5 door cycles (dependent on the temperature and charge level). The emergency battery recharges itself during normal operation. Optionally available for operator WA 300 S4 with integrated control.



**Soft start
Soft stop**

Quiet, gentle door travel sustainably increases the service life of the door system.



Easy to fit and service

Due to the standard power limit, doors without wicket door do not require any installations such as closing edge safety devices or cable slack switches on the door leaf. This reduces costs and the risk of repair and services.



**Lower investments,
lower consumption**

The WA 300 S4 costs approx. 30 % less than a 3-phase current operator. At the same time, daily power consumption is reduced by up to 75 %.

Shaft operators

WA 400 / WA 500 FU



WA 400

230 volt 1-phase current

- Max. opening speed 0.3 m/s
- Max. 10 door cycles per hour
- Max. door leaf weight 350 kg
- Max. door width 4500 mm
- Max. door height 4500 mm
- Can be combined with controls B445, B460

400 volt 3-phase current

- Max. opening speed 0.3 m/s
- Max. 15 door cycles per hour (optionally 20 door cycles per hour)
- Exceptionally smooth running
- Long on-time
- No restriction of door size
- Can be combined with controls A445, A 460

WA 500 FU. NEW

230 volt 1-phase current

- Soft start and soft stop for gentle door travel
- Max. opening speed 1.0 m/s
- Max. 25 door cycles per hour (optionally 30 door cycles per hour)
- Constant door travel speed also with track applications H and V
- Can be combined with controls 545, 560
- Standby under 2 W ¹⁾

¹⁾ Operator and control, if no other electrical accessories are connected



Watch the video at
www.hoermann.com/videos



Standard maintenance release

During the statutory annual inspection and maintenance work, it is not necessary for the operator to be removed from the door shaft. This saves you time and money. The maintenance release can be converted to a secured release at any time.



Optional emergency operation for maintenance release:

Emergency crank handle

The low-cost option is available in two versions, as a fixed crank handle or jointed emergency crank handle. Retrofitting with an emergency hand chain is possible.



Emergency hand chain

Through a combination of the emergency hand chain and the optional secured release, the door can be released or operated from the floor.



**Soft start
Soft stop**

Operator WA 500 FU

The frequency converter control takes stress off the entire mechanical door elements, guaranteeing nearly wear-free, quiet door travel.



**Opening speed
up to 1.0 m/sec**

Operator WA 500 FU with control 560

The new shaft operator WA 500 FU impresses with an opening speed of up to 1 m/s, streamlining workflows, speeding up logistics processes and reducing thermal losses.



**Adaptive door
action check**

Operator WA 500 FU

The frequency converter operators WA 500 FU / ITO 500 FU with intelligent speed control feature a compact design with high torques over a large speed range. The adaptive door action check recognises uneven door travel going beyond typical fluctuations, for example caused by reduced spring tension. In this case, the operators automatically switch to a temporary protection mode, signalling to the user that the door system requires maintenance.

Shaft operators, direct drive operators

Fitting versions



Operator to flange

WA 400, WA 500 FU (above)

This patented flange version is simple and easy to fit to the spring shaft and requires considerably less sideroom than the direct drive solutions from other manufacturers.

Operator with chain box

WA 400, WA 500 FU (above)

We recommend operators with chain box for all types of doors up to a height of 7500 mm if there is only sideroom of up to 200 mm. For track applications L and LD, an operator with chain box is required. Due to the indirect transmission of forces, the door is subjected to minimum wear and friction.



1.0 m/s opening speed

Operator WA 500 FU with chain box and control 560



**Operator for central mounting WA 400 M,
WA 500 M FU**

This version is mounted centrally on the spring shaft; as a result, no additional sideroom is necessary. Please observe the minimum headroom. The operator includes a secured release as a standard feature and is suitable for virtually any track application.

Direct drive operators S75 / S140

(not shown)

- Ready-to-fit direct drive operator with cable slack devices and integral catch safety device
- Power input: 3-phase current: 1.1 kW
- Protection category IP 65 (jet-water protected)
- Electronic absolute encoder (AWG) for determining the door position
- Microprocessor control in separate housing, with Open-Stop-Close membrane push button integrated in housing, miniature lock
- Self-monitoring closing edge safety device (SKS) via leading photocell VL 1-LE including protective covers
- Connection cable with CEE plug in protection category IP 44 (splash-water protected)
- Fitting of the control immediately next to the sectional door, plug-in door leaf sensors
- Including lintel trap guard EZS 1
- Including radio transmission (omission of coiled cable)
- Opening with impulse
- Closing with impulse
- Max. door leaf weight 700 kg (S75)
- Max. door leaf weight 1080 kg (S140)
- Max. door width 10000 mm
- Max. door height 7500 mm
- Can be combined with controls 445 R, 460 R

Chain drive operators with rail

ITO 400, ITO 500 FU, SupraMatic HT



ITO 400, ITO 500 FU

- No additional sideroom required
- Emergency release via Bowden cable on the slide carriage
- Maintenance release as standard
- Emergency release from the outside possible
- Optionally secured release on inside / outside (ideal for use on facade doors)
- For normal track application (N, ND) and low headroom track application (L, LD)
- Max. door height 4500 mm
- For doors with wicket door on request

ITO 500 FU. NEW

- Soft start and soft stop
- Max. opening speed 0.5 m/s
- Adaptive door action check (for further information, see page 77)

Operator SupraMatic HT

- Soft start and stop for gentle, quiet door travel
- Max. 300 door cycles (Open / Close) per day or max. 20 door cycles (Open / Close) per hour
- Pull and push force 1000 N (brief peak force 1200 N)
- Integrated control electronics including double 7-segment display for simple adjustment of operator functions directly on the operator
- Optional external control 360 (for connecting traffic control, warning lights or additional prints)
- Patented door locking in the operator boom with emergency release from inside
- Connecting lead with Euro plug, second suspension
- For doors with a spring safety device
- Up to 6750 mm width (7000 mm on request), or 3000 mm height
- For normal track application (N) and low headroom track application (L)
- For doors with wicket door, ALR F42 Glazing and real glass on request
- Not for sectional doors with 67 mm depth



0.5 m/s opening speed

For operator ITO 500 FU with control 560

Releases and emergency operation

For convenient operation

Secured release on inside (optional) 1

- For the convenient release of the operator from the floor (European patent)

Secured release from outside ASE (optional) 2

- To unlatch the door from the outside (required for buildings without a second entrance)
- Lockable die-cast housing with profile half cylinder
- Dimensions: 83 × 133 × 50 mm (W × H × D)

Emergency operation (optional) 3

- Recommended for doors over 3000 mm and fire station doors
- Secured release is required
- Meets the requirements of fire brigade standard DIN 14092 (depth of 42 to 5000 mm or depth of 67 up to a door width of 5500 mm)



Controls

Compatible system solutions



Internal control WA 300 S4 External control 360 Impulse control A / B 445, 445 R Comfort control A / B 460, 460 R Control 545 ■ NEW Control 560 ■ NEW

Operators	WA 300 S4	WA 400, ITO 400, S75, S140	WA 500 FU, ITO 500 FU
-----------	-----------	----------------------------	-----------------------

Functions / features

Control and operator can be mounted separately	●	●	●	●	●
Illuminated keyboard					●
Smart installation via BlueControl app via Bluetooth as standard				●	●
Adjustments made conveniently directly on the control		●	●	●	●
Soft start and soft stop	●	●		●	●
Adjustable high-speed opening and closing (depending on track application)	● ¹⁾	● ¹⁾		●	●
Power limit in Open and Close directions	● ²⁾	● ²⁾	A / B 445	A / B 460	●
Integrated Open / Stop / Close operation	●	●	●	●	●
Second opening height with additional button	○ ³⁾	●		●	●
7-segment display with menu reading from outside (maintenance, cycle, operating hours counter as well as error analysis)		2 x	2 x	2 x	4 x
Extension possible with external radio receiver	●	●	●	●	●
Query of the door position	○ ⁴⁾	○ ⁵⁾	○ ⁵⁾	○ ⁵⁾	○ ⁶⁾
2 timers for programming scenarios in 2 different time periods					●
Option relay as standard		●			●
HCP bus interface for intelligent accessories such as: SmartControl gateway				●	●
Automatic timer	● ⁷⁾	● ⁷⁾		● ⁷⁾	●
Traffic control ⁷⁾		○		○	○
Connecting terminals for additional command units	●	●	●	●	●
Power supply	230 V	230 V	400 / 230 V	400 / 230 V	230 V
Connection cable with CEE plug ⁸⁾ (IP 44)	●	●	●	●	●
Main switch integrated into control housing	○ ⁹⁾	○	○	○	○
Energy-saving function				●	●
Protection class IP 65 (jet-water protected) for controls and door leaf components	●	●	●	●	●

● = As standard

○ = With corresponding equipment possibly with additional control

¹⁾ In the Close direction during operation without SKS / VL (during operation with SKS / VL, the door generally travels at high speed in the Close direction)

²⁾ In accordance with EN 12453

³⁾ Possible in combination with UAP 1-300 and DTH-I or DTH-IM

⁴⁾ In combination with ESE BS, HS 5 BS

⁵⁾ In combination with HET-E2 24 BS, HS 5 BS and end-of-travel position feedback

⁶⁾ with ESE BS HCP or SmartControl gateway

⁷⁾ Only in combination with an activating kit for warning light and photocell or light grille or leading photocell VL 1-LE / VL 2-LE

⁸⁾ For controls with integrated main switch the connection cable is omitted

⁹⁾ External main switch possible or through control panel 300 U with integrated main switch

Optional equipment

For controls



Profile half cylinder
For all external controls



Main switch
For all external controls



Key switch post STI 1
For fitting a maximum of 2 controls with additional housing, colour: White aluminium, RAL 9006, Dimensions: 200 x 1660 x 60 mm (W x H x D)



Radio transmission unit
To transfer the signals from the door leaf to the control via Bluetooth (no coiled cable), power supply via a powerful battery; connectable components: optosensors LE (low energy), leading photocell VL 1-LE / VL 2-LE, 8k2 strip, cable slack switch, wicket door contact, night latch contact
For all controls



UPS system
For bridging power failures of up to 8 hours and up to 4 door cycles, safety devices, warning lights etc., remain functional, LED status display, automatic battery test, surge filter, protection category: IP 20
Dimensions: 560 x 235 x 260 mm (W x H x D)
For controls:
360, B 445, B 460, 545, 560



Battery unit
For control 545/560 incl. batteries; to buffer the time and date of the control if the mains voltage supply is interrupted for longer than the standard buffer of 60 hours

BlueControl. NEW

Smart set-up and adjustment of operator control via the app

The BlueControl app makes initial start-up, service and maintenance of industrial doors with the new controls 560 and 545 even easier and more convenient. Scan all door data via a QR code on the door and configure all settings in plain text. Existing configurations can be saved and transferred to similar door systems. During on-site service visits, all events are read and displayed in the app.

Advantages at a glance

- App for initial start-up, service and maintenance of industrial doors with controls 560 and 545
- App free to download and use
- Clear settings in plain text
- On-site access via Bluetooth without internet connection
- Simple scanning of the door data via QR code
- Convenient saving and transferring of templates for programming identical systems
- Fast overview of all menu settings
- Practical readout of events and errors with time stamp
- Time-saving forwarding of control data via e-mail
- Simple reset of maintenance counter

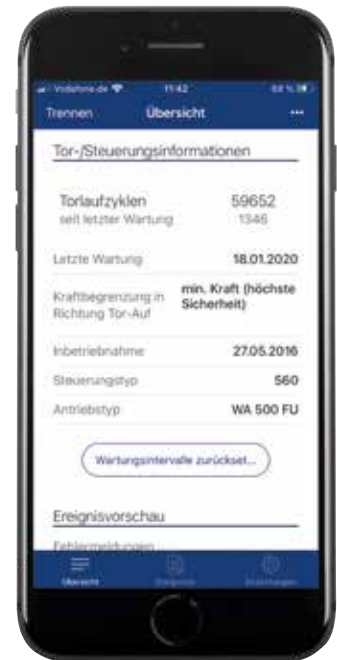



The new generation of industrial sectional doors can also be integrated into digital service and remote maintenance concepts. With the SmartControl online portal, you get an all-round carefree package for robust logistics processes with regard to your door system, minimising downtime due to preventive replacement of wearing parts.

Advantages at a glance

- 24/7 monitoring and technical door analysis, also remotely
- Online portal with all important door information, e.g. Error messages or door cycles
- No software installation required
- Cost-savings thanks to fewer and shorter service visits
- Fast troubleshooting thanks to online access to operator control
- Fewer and shorter downtimes due to early replacement of wearing parts
- Programming menu settings
- Push messages when configured events occur, e.g. max. door cycles for service visits
- Optimisation of service and maintenance scheduling through forward planning
- Connection of up to 2 controls of the series 500 possible
- Available for all Hörmann industrial doors with control 545 and 560



Controls

Air inlet control AC72

For smoke extraction concepts with industrial doors

Smoke and heat extraction systems are an essential part of preventive fire protection and personal safety. In the event of fire, windows and transom lights in the facade and ceiling area are opened, allowing smoke and fumes to be discharged from the building. At the same time, fresh air is supplied from below via building openings such as inlet flaps in the building facade.

Thanks to the air inlet control AC72, door systems can be integrated in smoke extraction concepts to securely supply fresh air. When the fire alarm system is triggered, the AC72 automatically transmits the impulse to open the door to the minimum required opening height within 60 seconds. Additionally, the AC72 complies with the general requirements for smoke extraction systems, such as monitored battery operation in case of power failure for 72 hours. By integrating industrial doors into the smoke extraction concept of your building, you can reduce investment and fitting costs of additional ventilation flaps and improve the thermal insulation of the building, as fewer doors have to be integrated into the facade.

RWA smoke and heat extraction

- Smoke extraction in the event of fire thanks to a robust, low-smoke layer near the floor (by using targeted air supply)
- To ensure escape and rescue routes

Qualified smoke extraction systems approved in accordance with DIN 12101-2 and dimensioned according to DIN 18232-2

- Required by building regulations (e.g. in assembly areas and industrial buildings)
- For building permits considering additional protective goals (e.g. property protection requirements by operator or insurance company)

Protective goals

- Support fire brigades in fire-fighting
- Personal safety
- Protection of production systems
- Protection of goods and raw materials
- Protection of building



Operator / control combinations for individual doors:

- Operator WA 300 R S4 with control 300 U



Operator / control combinations for doors with dock levellers:

- Operator WA 300 S4 with control 420 Si / 420 Ti



Equipment

Closing edge safety device

Tip

Leading photocells VL 1-LE

At no surcharge with operators
WA 400, ITO 400, WA 500 FU, ITO 500 FU

Closing edge safety device with optosensors or with leading photocell

All power-driven Hörmann industrial sectional doors with WA 400, ITO 400, WA 500 FU and ITO 500 FU operators are equipped with a self-monitoring closing edge safety device with optosensors as standard. You can also select the leading photocell VL 1-LE **1** for non-contact door monitoring of the closing edge at no surcharge. This solution offers you increased safety, faster door travel and lower inspection and maintenance costs.

Leading photocells

Using the leading photocells VL 1-LE **2** and VL 2-LE **3** means increasing the safety of Hörmann industrial sectional doors. The sensors monitor the bottom edge of the sectional door. Obstacles or persons are quickly recognised and the sectional door reverses before contact is made. Another benefit is the faster door travel speed.

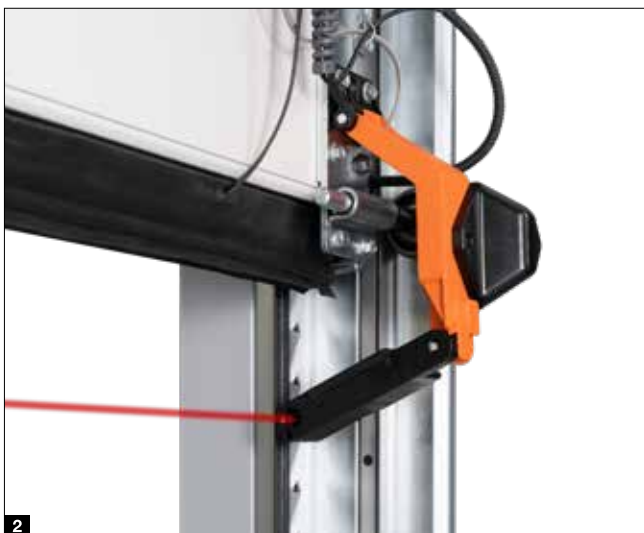
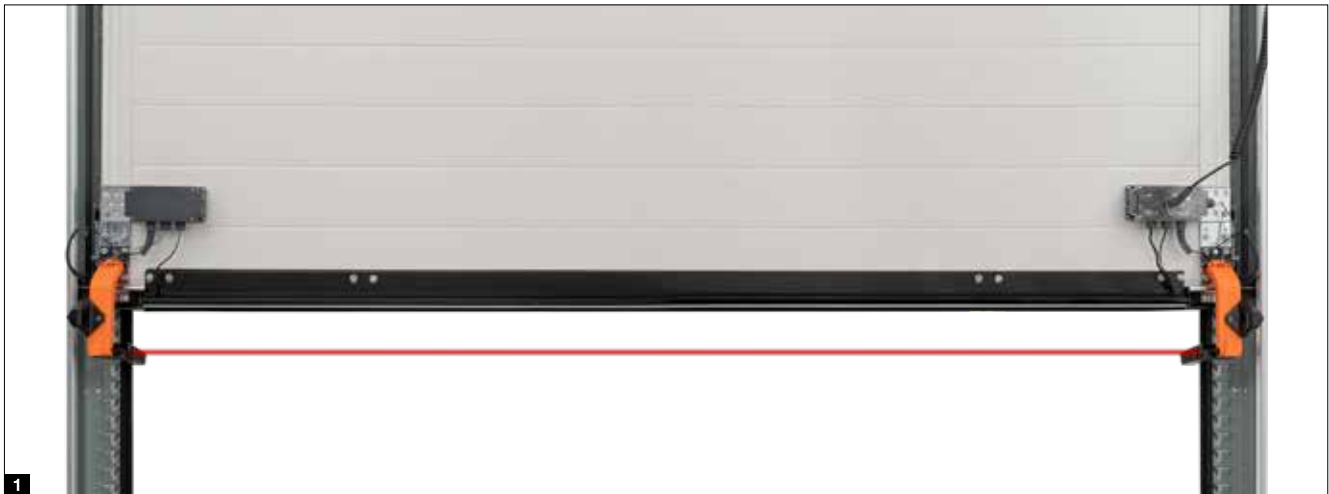

Benefits of leading photocells

Increased safety

Thanks to the non-contact automatic safety cut-out, persons and obstacles are quickly recognised without door contact. The door stops before contact is made and immediately travels upwards. This virtually eliminates the risk of damage or injury.

Faster door travel

The leading photocell can close the door at a speed of up to 30 cm/s. This reduces your energy costs due to shortened door opening times.

Lower inspection and maintenance costs

Industrial doors with non-contact door monitoring approved for personal safety purposes do not need to have their closing force approved. This means you save the extra costs for the additional inspection in accordance with ASR A1.7.

Protection for people and materials

The crash protection at the sides prevents the swivel arm from being damaged when the door is closed (Figures on right).



Equipment

Light grilles

Light grilles

Light grilles recognise persons and obstacles without making contact. This virtually eliminates the risk of damage or injury. A closing edge safety device with optosensors or additional photocells is not required.

Light grille HLG

- Light grille integrated in the frame **1**
- Good protection against damage and accidental readjustments
- Fitting bracket for optimal fixing and alignment in the frame

Light grille HLG-V as advance protection

- Main closing edge safeguard up to a height of 2500 mm
- Fitting outside on the facade, in the reveal **2** or on the door frame **3**
- Optionally integrated in key switch post STL **4** consisting of weather-resistant anodised aluminium

Light grille HLG for doors with wicket door

- Double light grille for doors with wicket door with trip-free threshold
- Main closing edge safeguard up to a height of 2500 mm
- Fitting on the door frame and on the outside in the reveal **5**
- Radio transmission unit required (see page 83 for more information)

- Maximum safety thanks to especially effective recognition of people and obstacles via angled beams
- Increased personal safety with especially close arrangement of the sensors up to a height of 500 mm (above FFL)
- Reduced energy losses thanks to door closing at speeds of up to 1 m/s*
- Easy retrofitting of existing doors with closing edge safety device with optosensors with the HLG light grille
- Low inspection and maintenance costs, inspection of the closing force in accordance with ASR A1.7 not necessary

* WA 500 FU and controls 560 up to a height of 2500 mm, depending on track applications and sizes

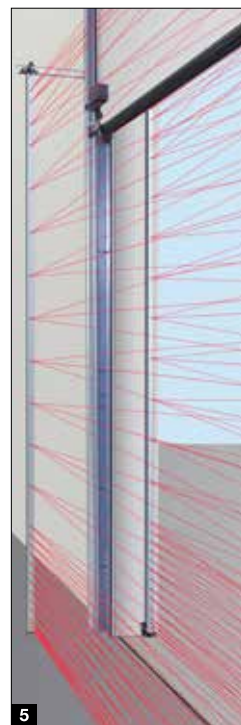
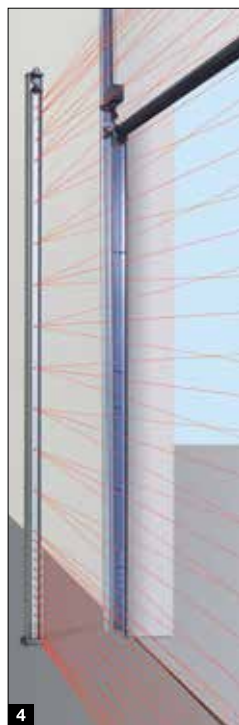
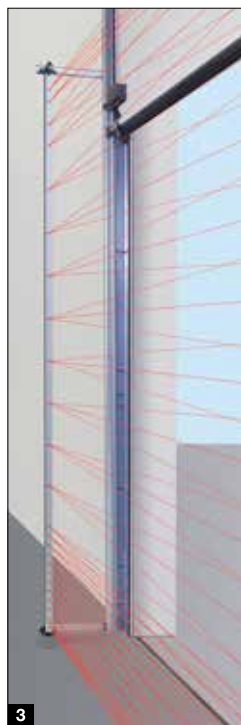
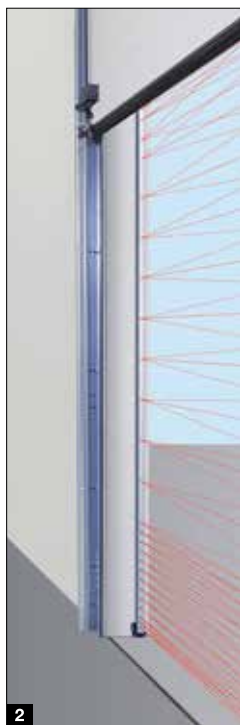
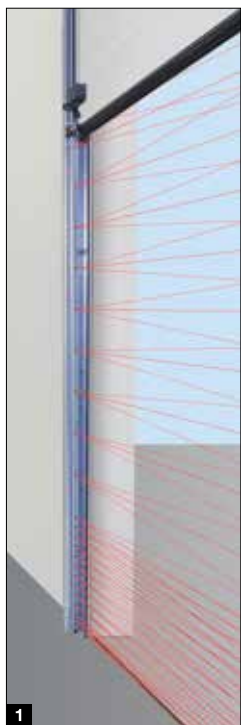



Reflection photocell RL 50 / RL 300

Photocell with transmitter / receiver module and reflector; photocell tested by control before every downward movement; connection via system cable (RL 50, length 2 m) / 2-wire cable (RL 300, length 10 m); dimensions: 45 x 86 x 39 mm (W x H x D); protection category: IP 65; reflector range up to 8 m (standard); 30 x 60 mm (W x H), reflector range up to 12 m (not shown); 80 mm diameter; optional weather protective cover (not shown), anti-fog coating



One-way photocell EL 51

Photocell with separate transmitter and receiver; photocell tested by control before every downward movement; connection via system cable; max. range 8 m; dimensions with fitting bracket: 45 x 85 x 31 mm (W x H x D); protection category: IP 65; optional weather protective cover (not shown)

One-way photocell EL 401

Photocell integrated in the door frame with separate transmitter and receiver; photocell tested by control before every downward movement; connection via system cable; dimensions (W x H x D): Ø 25 mm, depth 55 mm; protection category: IP 65; not in combination with VL 1-LE, VL 2-LE or HLG



Accessories

Hand transmitter, radio switch, receiver



HS 5 BS
4 button functions,
plus query button, high-gloss
surface black or white



HS 5 BS
4 button functions,
plus query button,
textured surface matt black



HS 4 BS
4 button functions,
textured surface matt black



HS 1 BS
1 button function,
textured surface matt black



HSE 1 BS
1 button function,
including eyelet for key ring,
textured surface matt black



HSE 4 BS
4 button functions, incl. eyelet
for key ring, textured surface matt
black with chrome or plastic caps



4-button security hand transmitter HSS 4 BS
Additional function: copy protection for hand transmitter coding,
with chrome caps



Only from Hörmann

Modern radio system

The bi-directional radio system BiSecur is based on future-oriented technology for the convenient and secure operation of industrial doors. The extremely secure BiSecur encryption protocol makes sure that no-one can copy your radio signal. It was tested and certified by security experts at Bochum university.

Your advantages

- 128-bit encryption with the same high security level as online banking
- Interference-resistant radio signal with a stable range
- Convenient querying of the door position*
- Backwards compatible, i.e. radio receivers with the frequency 868 MHz (2005 to June 2012) can also be operated with BiSecur control elements

* With WA 300 S4 with optional bi-directional receiver ESEI BS, for all other operators with optional bi-directional receiver HET-E2 24 BS and end-of-travel position feedback



Radio code switch FCT 3 BS
3 functions, with illuminated buttons, recessed or surface-mounted fitting possible, plastic housing in Light grey RAL 7040 (also available with 10 functions and hinged cover, painted in White aluminium RAL 9006)



Radio code switch FCT 10 BS
10 functions, with illuminated buttons and hinged cover, recessed or surface-mounted fitting possible, plastic housing in White aluminium RAL 9006



Radio finger-scan FFL 25 BS
2 functions and up to 25 fingerprints, with hinged cover, recessed and surface-mounted fitting possible, plastic housing painted in White aluminium RAL 9006



Radio radar button FSR 1 BS
Sensor for non-contact opening, plastic housing, IP 41 for recessed and surface-mounted fitting

Radar button HTR 1-230 / 1-24
Wired version with 230 V or 24 V



Industrial hand transmitter HSI 6 BS, HSI 15 BS
To control up to 6 doors (HSI 6 BS) or 15 doors (HSI 15 BS), with extra-large buttons for easier operation with work gloves, impact-resistant housing
Protection category: IP 65



Industrial hand transmitter HSI BS
To control up to 1000 doors, with a display and extra-large quick selection buttons for easier operation with work gloves, transferring of hand transmitter coding to other devices possible



3-channel receiver HEI 3 BS
For controlling 3 functions



Bi-directional receiver ESEi BS
For querying the door position



1-channel relay receiver HER 1 BS
1 volt-free relay output with status query



2-channel relay receiver HER 2 BS
2 volt-free relay outputs with status query and external antenna



2-channel relay receiver HET-E2 24 BS
2 volt-free relay outputs for choosing the direction, one 2-pin input for volt-free Open and Close limit switch reporting (for querying the door position)



4-channel relay receiver HER 4 BS
4 volt-free relay outputs with status query

Accessories

Button



Push button DTH-R
Separate control of both operational directions; separate stop button

Dimensions:
90 × 160 × 55 mm (W × H × D)
Protection category: IP 65



Push button DTH-RM
Separate control of both operational directions; separate stop button, with miniature lock: Control of the operator is deactivated – operator movement is no longer possible (2 keys included in the scope of delivery)

Dimensions:
90 × 160 × 55 mm (W × H × D),
protection category: IP 65



Push button DTH-I
To move the door into the Open / Close positions, separate stop button to stop door travel, 1/2 Open button to open the door up to the programmed intermediate travel limit, protection category: IP 65,

Dimensions:
90 × 160 × 55 mm (W × H × D)

With integrated control WA 300 S4, only in combination with UAP 1-300, not for control 445/545



Push button DTH-IM
To move the door into the Open / Close positions, separate stop button to stop door travel, 1/2 Open button to open the door up to the programmed intermediate travel limit, with miniature lock: operator control is deactivated, operator movement is no longer possible (2 keys included in the scope of delivery)

Dimensions:
90 × 160 × 55 mm (W × H × D)
Protection category: IP 65

With integrated control WA 300 S4, only in combination with UAP 1-300, not for control 445/545



Push button DT 02
Opening or closing via a command button, separate stop button

Dimensions:
75 × 145 × 70 mm (W × H × D),
Protection category: IP 65



Push button DT 03
Separate control of both operational directions; separate stop button

Dimensions:
75 × 180 × 70 mm (W × H × D),
Protection category: IP 65



Push button DT 04
Separate control of both operational directions; separate stop button, partial opening (separate button)

Dimensions:
75 × 225 × 70 mm (W × H × D),
Protection category: IP 65

With integrated control WA 300 S4, only in combination with UAP 1-300, not for control 445/545



Push button DTN A 30
For separate control of both operational directions; stop button is a push-to-lock button which, once pressed, stays depressed in order to prevent unauthorised operation; subsequent actuation is then only possible through unlocking with a key (2 keys included in the scope of delivery)

Dimensions:
75 × 180 × 105 mm (W × H × D),
Protection category: IP 65



Push button DTP 02

Opening or closing via a command button, separate stop button, operation control light for control voltage, lockable with profile half cylinder (available as an accessory),

Dimensions:
77 × 235 × 70 mm (W × H × D),
Protection category: IP 44



Push button DTP 03

For separate control of both operational directions, separate stop button, operation control light for control voltage, lockable with profile half cylinder (available as an accessory),

Dimensions:
77 × 270 × 70 mm (W × H × D),
Protection category: IP 44



Emergency-off button DTN 10

Fast immobilisation of the door system; push-to-lock button (mushroom button); surface-mounted,

Dimensions:
93 × 93 × 95 mm (W × H × D),
Protection category: IP 65



Emergency-off button DTNG 10

Quick immobilisation of the door system; push-to-lock mushroom button; surface-mounted

Dimensions:
93 × 93 × 95 mm (W × H × D),
Protection category: IP 65

The lockable function serves to isolate the control voltage and immobilises the command units. Profile half cylinders are not included in the scope of delivery for the push buttons.



Key switch ESU 30 with 3 keys, recessed version, Impulse or Open / Close functions selectable
Dimensions of the switch box: 60 mm (d), 58 mm (D), dimensions of the cover: 90 × 100 mm (W × H), Brickwork recess: 65 mm (d), 60 mm (D);
Protection category: IP 54

Surface-mounted version ESA 30 (not shown)
Dimensions: 73 × 73 × 50 mm (W × H × D)



Key switch STAP 50 with 3 keys, surface-mounted version, dimensions: 80 × 80 × 63 mm (W × H × D);
Protection category: IP 54

Key switch STUP 50 with 3 keys, recessed version (not shown)
Dimensions: 80 × 80 mm (W × H);
Protection category: IP 54



Pull switch ZT 2 with cord

Impulse transmission to open or close the door

Dimensions:
60 × 90 × 55 mm (W × H × D);
Pull cord length: 3.2 m;
Protection category: IP 65

Cantilever arm KA1 (not shown)
Extension 1680 – 3080 mm, can be used with ZT 2



Key switch posts

With a screw base for fitting to the floor, surface finish in White aluminium RAL 9006, 90 × 90 mm tube, also available as a set-in-concrete version

Key switch post STN 1

To hold 1 command unit on the surface, height 1050 mm

Key switch post STN 1-1

To hold 2 command units or 1 command unit and 1 warning light, height 1200 mm

For command units:
CTR 1b-1, CTR 3b-1, CTV 3-1, CTP 3-1, TTR 1000-1, FL 150, STUP 50, LED double warning lights red / green

Accessories

Button, switch, receiver



Code switch CTR 1b-1, CTR 3b-1

For 1 (CTR 1b-1) or 3 (CTR 3b-1) functions, with illuminated buttons,

Dimensions:
80 × 80 × 15 mm (W × H × D)



Code switch CTV 3-1

For 3 functions, with particularly robust metal keypad,

Dimensions:
80 × 80 × 15 mm (W × H × D)



Code switch CTP 3

For 3 functions, with illuminated lettering and touch-sensitive surface,

Dimensions:
80 × 80 × 15 mm (W × H × D)



Decoder housing

For code switch CTR 1b-1, CTR 3b-1, CTV 3-1, CTP 3

Dimensions:
140 × 130 × 50 mm (W × H × D),
switching capacity: 2.5 A / 30 V DC
500 W / 250 V AC



Finger-scan FL 150

For 2 functions, up to 150 fingerprints can be saved

Dimensions:
80 × 80 × 13 mm (W × H × D);
decoder housing:
70 × 275 × 50 mm (W × H × D);
switching capacity: 2.0 A / 30 V DC



Radar movement detector RBM 2

For "Open door" impulse with directional recognition, max. fitting height: 6 m; optional remote control for radar movement detector

Dimensions:
155 × 132 × 58 mm (W × H × D);
contact load: 24 AC / DC, 1 A
(resistive load); protection
category: IP 65



Transponder key switch TTR 1000-1

For 1 function via transponder key or transponder card, up to 1000 keys or cards can be saved,

Dimensions: 80 × 80 × 15 mm (W × H × D);
Decoder housing: 140 × 130 × 50 mm (W × H × D);
Switching capacity: 2.5 A / 30 V DC; 500 W / 250 V AC





Bluetooth receiver HET-BLE

For operation, impulse control of industrial sectional doors via the Hörmann BlueSecur app

Dimensions:

110 x 45 x 40 mm (W x H x D)



UAP 1-300

For WA 300 R S4 or control 300; impulse selection, partial opening function, limit switch reporting and activating kit for warning light with 2 m system cable,

Dimensions:

150 x 70 x 52 mm (W x H x D);

max. switching capacity:

0 V DC / 2.5 A (resistive load),

250 V AC / 500 W (resistive load);

protection category: IP 65



3D laser scanner Scanprotect

Thanks to laser technology, the high-end motion detector and monitoring system guarantees operational safety, even with different floor coverings.

- Especially suited for outdoor areas as it is not susceptible to different weather conditions
- Reliable advance protection, as well as fast and targeted automatic door opening
- Convenient setting options via the operator control
- Easy to hide objects permanently or temporarily in the detection range
- Deactivation of cross-traffic and pedestrian traffic
- Automatic partial opening up to a defined height for people or vehicles
- Virtual pull switch enables door opening by people or vehicles standing at a defined position
- Visible LED spots on the floor assist during setup
- Easy connection to the operator control with plug-in wiring
- Bluetooth module for convenient configuration via app, e.g. with visualisation of the set field sizes in real-time



HOR 1-300

For WA 250 R S4, WA 300 R S4 or control 300 to control limit switch reporting or warning lights with 2 m connecting lead; optionally available for fitting in push button control 300 U (not shown)

Dimensions:

110 x 45 x 40 mm (W x H x D);

Max. switching capacity:

30 V DC / 2.5 A (resistive load),

250 V AC / 500 W (resistive load);

protection category: IP 44



KNX gateway

For controls 545, 560

For the control of Hörmann operators and controls via the KNX building automation

Accessories

Activating kits, LED warning lights



Multi-function circuit board to be fitted in an existing housing or optionally in a separate extension housing (shown)

Limit switch reporting, momentary impulse, collective malfunction signalling, extension unit for controls

Dimensions of additional housing: 202 × 164 × 130 mm (W × H × D);
Protection category: IP 65

A circuit board can be optionally mounted in the control.



Digital weekly timer in a separate additional housing

The timer can switch command units on and off via a volt-free contact.; extension unit for controls (for fitting in an existing housing)
Switching capacity: 230 V AC 2.5 A / 500 W, can be switched over to summer / winter time, manual switching: automatic operation, switching preselection permanently ON / OFF

Dimensions of additional housing: 202 × 164 × 130 mm (W × H × D);
protection category: IP 65



Summer / winter activating kit in additional housing

Function for full door opening and individually programmable intermediate travel limit, extension unit for controls

Dimensions of additional housing: 202 × 164 × 130 mm (W × H × D);
protection category: IP 65

Not for control 445/545



DI 1 induction loop in a separate additional housing

Suitable for one induction loop, detector with a normally open contact and a change-over contact



DI 2 induction loop (not shown) in a separate additional housing,

Suitable for two separate induction loops, detector with two potential-free closing contacts, can be set for impulse or permanent contact, directional recognition possible

Dimensions of additional housing: 202 × 164 × 130 mm (W × H × D);
switching capacity: DI 1: low voltage 2 A, 125 V A / 60 W; DI 2: 250 V AC, 4 A, 1000 VA (resistive load AC); supplied without loop cable

Loop cable for induction loop: 50 m roll, cable designation: SIAF,
cross-section: 1.5 mm², colour: brown



Activating kit for warning lights for fitting in an existing housing or optionally in a separate extension housing (shown),

Incl. 2 LED warning lights TL40S ye **2**; extension unit for control, with activating kit for warning lights as a visual indicator during door travel (weekly timer optional)

Applications: approach warning, automatic timer

After the set hold-open phase has elapsed (0 – 480 s), the warning lights flash during the set pre-warning phase (0 – 70 s).

Dimensions of additional housing: 202 × 164 × 130 mm (W × H × D),

Contact load: 250 V AC; 2.5 A / 500 W

Protection category: IP 65



Traffic control in a separate additional housing or for fitting in an existing housing (only for controls 360, 460, 560)

Incl. 2 LED warning lights TL40S rd / gn **4** or 2 LED warning lights TL40S rd / ye* / gn **5**; extension unit for control, with activating kit for warning lights as a visual indicator for regulating the entrance and exit (optional weekly timer);

duration of the green phase: adjustable from 0 – 480 s,

duration of the clearance phase: adjustable from 0 – 70 s

Dimensions of additional housing: 202 × 164 × 130 mm (W × H × D),

contact load: 250 V AC: 2.5 A / 500 W;

Protection category: IP 65

* Yellow is not required for traffic control



1

Red LED warning light TL40S

1-arm red (230 V / 50 Hz)

Traffic light dimensions:
180 × 250 × 290 mm
(W × H × D)



2

LED warning light TL40S ye

1-arm yellow (230 V / 50 Hz)

Traffic light dimensions:
180 × 250 × 290 mm
(W × H × D)



3

LED warning light TL40S gn

1-arm green (230 V / 50 Hz)

Traffic light dimensions:
180 × 250 × 290 mm
(W × H × D)



4

LED warning light TL40S rd / gn

2-arm red / green (230 V / 50 Hz)

Traffic light dimensions:
180 × 410 × 290 mm
(W × H × D)



5

LED warning light TL40S rd / ye / gn

1-arm red / yellow / green (24 V DC)

Traffic light dimensions:
180 × 250 × 290 mm
(W × H × D)

Performance characteristics

Acc. to EN 13241

Door types	SPU F42	SPU 67 Thermo	APU F42	APU F42 Thermo	APU 67 Thermo	ALR F42	ALR F42 Thermo	ALR 67 Thermo
Wind load	Class according to EN 12424							
Door without wicket door	3 ²⁾ / 4 ^{1, 2)}	3 ²⁾ / 4 ^{1, 2)}	3 / 4 ¹⁾	3 / 4 ¹⁾	3 / 4 ¹⁾	3 / 4 ¹⁾	3 / 4 ¹⁾	3 / 4 ¹⁾
Door with wicket door	2 ²⁾ / 3 ^{1, 2)}	2 ²⁾ / 3 ^{1, 2)}	2 / 3 ¹⁾	2 / 3 ¹⁾	2 / 3 ¹⁾	2 / 3 ¹⁾	2 / 3 ¹⁾	2 / 3 ¹⁾
Water tightness	Class according to EN 12425							
Door without / with wicket door	3 (70 Pa)	3 (70 Pa)	3 (70 Pa)	3 (70 Pa)	3 (70 Pa)	3 (70 Pa)	3 (70 Pa)	3 (70 Pa)
Air permeability	Class according to EN 12426							
Door without wicket door	2	2 / 3 ^{5, 6)}	2	2	2 / 3 ^{5, 6)}	2	2	2 / 3 ^{5, 6)}
Door with wicket door	1	1	1	1	1	1	1	1
Acoustic insulation ³⁾	R [db] according to EN ISO 717-1							
Door without wicket door	25 ³⁾	25 ³⁾	23	23	23	23 / 30 ⁴⁾	23 / 30 ⁴⁾	23 / 30 ⁴⁾
Door with wicket door	24 ³⁾	24 ³⁾	22	22	22	22 / 29 ⁴⁾	22 / 29 ⁴⁾	22 / 29 ⁴⁾
Thermal insulation	U-value = W/(m ² ·K) according to EN 13241, Appendix B, for a door surface of 5000 × 5000 mm							
Door without / with wicket door								
Fitted door	1.0 / 1.2	0.62 / 0.82						
With ThermoFrame	0.94 / 1.2	0.51 / 0.75						
Synthetic double panes			3.4 / 3.6	2.9 / 3.1		3.6 / 3.8	3.0 / 3.2	
With ThermoFrame			3.3 / 3.6	2.8 / 3.1		3.6 / 3.8	3.0 / 3.2	
Synthetic triple panes			3.0 / 3.2	2.5 / 2.7	2.1 / 2.3	3.2 / 3.4	2.6 / 2.8	2.2 / 2.4
With ThermoFrame			2.9 / 3.1	2.4 / 2.6	2.0 / 2.2	3.1 / 3.4	2.5 / 2.8	2.1 / 2.3
Synthetic quadruple pane					1.8 / 2.0			1.9 / 2.1
With ThermoFrame					1.7 / 1.9			1.8 / 2.1
Climatic double pane			2.5 / 2.7	2.0 / 2.2	1.6 / 1.8	2.7 / 2.9	2.1 / 2.3	1.7 / 1.9
With ThermoFrame			2.4 / 2.6	1.9 / 2.1	1.5 / 1.7	2.6 / 2.8	2.0 / 2.2	1.6 / 1.8
Double real glass pane			3.4 / 3.6	2.9 / 3.1	2.6 / 2.8	3.6 / 3.8	3.0 / 3.2	2.7 / 2.9
With ThermoFrame			3.3 / 3.6	2.8 / 3.0	2.5 / 2.7	3.6 / 3.8	3.0 / 3.2	2.6 / 2.8
Single real glass pane								
With ThermoFrame								
¹⁾ For door widths up to 4000 mm ²⁾ Lower class rating may apply for doors with compound glazing ³⁾ For doors without glazing frame ⁴⁾ Information refers to thermal insulation values with real glass pane (optional) ⁵⁾ With ThermoFrame ⁶⁾ Only for Micrograin surface finish								
Side doors	NT 60 for SPU	NT 60 for APU	NT 60 for ALR	NT 60 for ALR Vitraplan	NT 80 Thermo for SPU	NT 80 Thermo for APU	NT 80 Thermo for ALR	
Wind load	3C	3C	3C	3C	4C	4C	4C	
Class according to EN 12424								
Air permeability	3	3	3	3	3	3	3	
Class according to EN 12426								
Water tightness under heavy rain	1A	1A	1A	1A	1A	1A	1A	
Unprotected, opening outwards								
Thermal insulation	2,9	4,2	4,7	4,7	1,6	2,2	2,4	
U-value = W/(m ² ·K) according to EN 13241, Appendix B, for a door size of 1250 × 2200 mm								

ALR F42 Glazing	ALR 67 Thermo Glazing	ALR F42 Vitraplan	Glazings / infills	U _g value W/(m ² ·K)	τ _v value	g value
3/4 ¹⁾	3/4 ¹⁾	3/4 ¹⁾	Synthetic panes			
			Single pane, 3 mm			
			Clear		0,88	
			Crystal structure		0,84	
			Double pane, 26 mm			
			Clear	2,6	0,77	0,74
			Crystal structure	2,6	0,77	0,74
			Grey tinted	2,6	0,03	0,28
			Brown tinted	2,6	0,03	0,25
			White tinted (opal)	2,6	0,69	0,69
			Triple pane, 26 mm			
			Clear	1,9	0,68	0,67
			Crystal structure	1,9	0,68	0,67
			Grey tinted	1,9	0,03	0,25
			Brown tinted	1,9	0,03	0,23
			White tinted (opal)	1,9	0,61	0,63
			Triple pane, 51 mm			
			Clear	1,6	0,68	0,67
			Crystal structure	1,6	0,68	0,67
			Grey tinted	1,6	0,03	0,25
			Brown tinted	1,6	0,03	0,22
			White tinted (opal)	1,6	0,61	0,63
			Quadruple pane, 51 mm			
			Clear	1,3	0,60	0,61
			Crystal structure	1,3	0,60	0,61
			Grey tinted	1,3	0,02	0,23
			Brown tinted	1,3	0,02	0,20
			White tinted (opal)	1,3	0,54	0,58
			Polycarbonate panes			
			Single pane, 6 mm			
			Clear	-	-	-
			Double pane, 26 mm			
			Clear	2,7	0,81	0,75
			Real glass panes			
			Single pane, 6 mm			
			Clear	5,7	0,88	0,79
			Double pane, 26 mm			
			Clear	2,7	0,81	0,76
			Climatic double pane, 26 mm			
			Clear	1,1	0,80	0,64
			Infill			
			Multiple-moulded pane	1,9	0,57	0,62

Vitraplan attachments on request

U_g value Thermal insulation value
τ_v value Light transmission (transparency)
g value Total energy transmittance

Construction and quality features

Acc. to EN 13241

	SPU F42	SPU 67 Thermo	APU F42	APU F42 Thermo	APU 67 Thermo
Construction					
Self-supporting	●	●	●	●	●
Depth, mm	42	67	42	42	67
Door sizes					
Max. width mm, LZ	8000	10000	8000	7000	10000
Max. height mm, RM	7500	7500	7500	7500	7500
Material, door leaf					
Double-skinned steel section	●	-	●	●	-
Double-skinned steel section with thermal break	-	●	-	-	●
Aluminium profile	-	-	●	-	-
Aluminium profile with thermal break	-	-	-	●	●
Surface, door leaf					
Galvanized steel, coated RAL 9002	●	●	○	○	○
Galvanized steel, coated RAL 9006	○	○	●	●	●
Galvanized steel, coated RAL to choose	○	○	○	○	○
Anodised aluminium E6 / C0	-	-	●	●	●
Aluminium coated in RAL to choose	-	-	○	○	○
Aluminium coated in brown / grey	-	-	-	-	-
Wicket door					
	○	○	○	○	○
Side doors					
Side door NT 60 matching the door	○	○	○	○	○
Side door NT 80 Thermo matching the door	○	○	○	○	○
Glazings					
Type A section windows	○	○	-	-	-
Type D section windows	○	○	-	-	-
Type E section windows	○	-	-	-	-
Aluminium glazing frames	○	○	●	●	●
Seals					
All-round on 4 sides	●	●	●	●	●
Intermediate seal between the door sections	●	●	●	●	●
ThermoFrame					
	○	○	○	○	○
Locking systems					
Inside locking	●	●	●	●	●
Outside / inside locking	○	○	○	○	○
Anti-lift kit					
For doors of up to 5 m height with shaft operator	●	●	●	●	●
Safety equipment					
Finger trap protection	●	-	●	●	-
Side trap guards	●	●	●	●	●
Safety catch for doors	●	●	●	●	●
Fastening options					
Concrete	●	●	●	●	●
Steel	●	●	●	●	●
Brickwork	●	●	●	●	●
Others on request					

● = As standard

○ = Optional

ALR F42	ALR F42 Thermo	ALR 67 Thermo	ALR F42 Glazing	ALR 67 Thermo Glazing	ALR F42 Vitraplan
● 42	● 42	● 67	● 42	● 67	● 42
8000 7500	7000 7500	10000 7500	5500 4000	5500 4000	6000 7000
-	-	-	-	-	-
-	-	-	-	-	-
●	-	-	●	-	●
-	●	●	-	●	-
-	-	-	-	-	-
-	-	-	-	-	-
●	●	●	●	●	-
○	○	○	○	○	-
-	-	-	-	-	●
○	○	○	-	-	-
○	○	○	○	○	○
○	○	○	○	○	-
-	-	-	-	-	-
-	-	-	-	-	-
-	-	-	-	-	-
●	●	●	●	●	●
●	●	●	●	●	●
○	○	○	○	○	○
●	●	●	●	●	●
○	○	○	-	-	-
●	●	●	●	●	●
●	●	-	●	-	●
●	●	●	●	●	●
●	●	●	●	●	●
●	●	●	●	●	●

Everything from a single source for construction and industry

Our large product range offers the right solution for any requirement. All products are optimally adjusted to work together, ensuring high functional safety. This makes us a strong, future-oriented partner for industrial and public construction projects.

**INDUSTRIAL DOORS. LOADING TECHNOLOGY. SLIDING DOORS.
CONSTRUCTION PROJECT DOORS. PERIMETER PROTECTION SYSTEMS**



Some of the doors shown are equipped with special equipment and do not always correspond to the standard versions. The surface finishes and colours shown are subject to the limitations of the printing process and cannot be regarded as binding. All rights reserved. No part may be reproduced without our prior permission. Subject to changes.