

art decor keramik

Garten Katalog

2024



BRUNNEN



FIGUREN



TEICHZUBEHÖR



VOGELTRÄNKEN



LICHTTECHNIK



NATURSTEIN



PUMPENTECHNIK



www.art-decor-keramik.de

Inh. Armin Bornheimer • Breslauer Str. 5 • 46342 Velen-Ramsdorf • Tel.: +49 (0) 28 63 / 73 75
Fax: +49 (0) 28 63 / 76 15 57 • Mobil: +49 (0) 171 / 6 59 24 29 • Mail: art-decor-keramik@t-online.de

Bronze-Wasserspeier.....	2
Schiefersäulen mit Bronze-Figuren	3
Natursteinsäulen mit Bronze-Figuren	4-5
Brunnenkomplettsets	6
Vogeltränken	7
Natursteinfindlinge mit Bronze-Figuren	8
Wasserspiele und Quellkugeln	9
Terrassenbrunnen, Wasserwände und Quellkugeln.....	10
Wasserspiele Edelstahl und Cortenstahl	11-12
PE-, Fiberglas-, GFK-Becken & Deckel.....	13
Zubehör & Umrandungen	14
Zubehör	15
Bachlaufelemente.....	16
Wasserpflanzkörbe & Teichzubehör.....	17
Energieverteiler, Nebelgeräte & Zubehör	18
Pumpentechnik für den Außenbereich.....	19
Aquafall-Edelstahlauslauf und Aqualine	20
LED-Leiste und Zubehör	21
Aquaspot 12 V	22
Aqualight 24 V Set.....	23
Netzgeräte	24
Wasser- & Lichttechnik	25
Quellstar 600 / Quellstar Pro 600.....	26
Quellstar 900 / Quellstar Pro 900.....	27
Quellstar 2000 / Quellstar Pro 2000.....	28
Skimmer & Zimmerbrunnen-Pumpen.....	29
Teich- & Bachlaufpumpen	30-32
Fittinge	33
Steinguss	34-85
Edelstahlrost-Programm	86-87

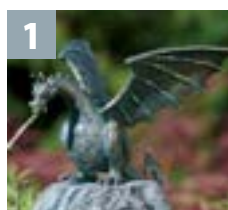

1

**DRACHE
TERRADOR**
klein, wasserspeierend
H 20 x B 28 x T 25 cm
Art.-Nr. 90169

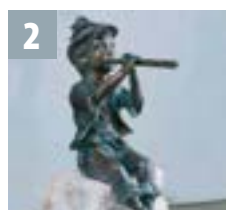

2

ANTONIO
wasserspeierend
– ohne Findling
H 40 x B 16 x T 28 cm
Art.-Nr. 991240



3

**FLÖTENSPIELER
FINN**
– ohne Findling
H 26 x B 12 x T 12 cm
Art.-Nr. 891246

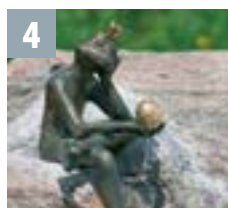

4

**FROSKHÖNIG
BORRIS**
H 35 x B 18 x T 23 cm
Art.-Nr. 88764



5

**FROSKHÖNIG
GUNTER**
H 32 x B 17 x T 24 cm
Art.-Nr. 88765



6

**FROSKHÖNIG
DIETMAR**
H 29 x B 51 x T 17 cm
Art.-Nr. 88767

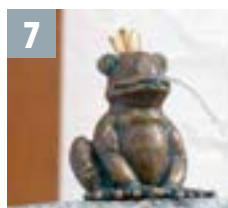

7

**FROSKHÖNIG
OTTO**
H 11 x B 9 x T 8 cm
Art.-Nr. 88724



8

**FROSKHÖNIG
ALBERT**
H 11 x B 7 x T 7 cm
Art.-Nr. 88880

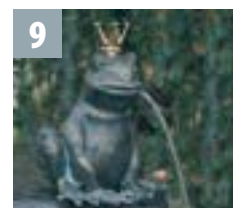

9

**FROSKHÖNIG
RATOMIR**
H 17 x B 18 x T 13 cm
Art.-Nr. 88494



10

**FROSKHÖNIG
MARTIN**
H 13 x B 10 x T 13 cm
Art.-Nr. 89016



11

**FROSKHÖNIG
LEOPOLD**
H 20 x B 11 x T 11 cm
Art.-Nr. 88500



12

FROSCH
wasserspeierend
H 11 x B 13 x T 16 cm
Art.-Nr. 90110

UNSER TEAM

GESCHÄFTSFÜHRUNG

Armin Bornheimer
Tel. 0 28 63/73 75
Fax 0 28 63/76 15 57
Mobil 0171/6 59 24 29
Mail bornheimer@art-decor-keramik.de

BÜRO / BUCHHALTUNG



Silvia Heimann
Tel. 0 28 63/76 12 37
Fax 0 28 63/76 12 41
Mail heimann@art-decor-keramik.de

AUSSENDIENST



Stefan Schwarz
Mobil 0177/6 68 33 87
Mail schwarz@art-decor-keramik.de



1

SCHIEFERSÄULE mit Vogel
ca. H 55 x B 25 x T 16 cm Art.-Nr. 88498.5



2

SCHIEFERSÄULE mit Eisvogel
ca. H 55 x B 25 x T 16 cm Art.-Nr. 88320.5



3

SCHIEFERSÄULE mit Eisvogel
ca. H 75 x B 25 x T 16 cm Art.-Nr. 88321.5



4

SCHIEFERSÄULE mit Eisvogel
ca. H 55 x B 25 x T 16 cm Art.-Nr. 89003.5



5

SCHIEFERSÄULE mit Eisvogel
ca. H 65 x B 25 x T 16 cm Art.-Nr. 89004.5



6

SCHIEFERSÄULE mit Stimmungsraube
ca. H 75 x B 25 x T 16 cm Art.-Nr. 89051.5



7

Turmfalke auf STEINSÄULE
Farbe: White / Purple Art.-Nr. 88462.8



8

ADLER auf Steinsäule ca. 80 cm hoch
Farbe: White / Purple Art.-Nr. 88631.8

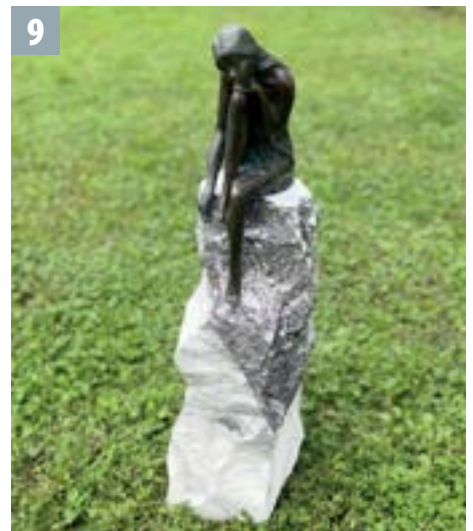

9

EMANUELLE auf Steinsäule ca. 80 cm hoch
Farbe: White / Purple Art.-Nr. 88574.8

1



FROSKÖNIG auf Steinsäule ca. 80 cm hoch
 Farbe: White / Purple Art.-Nr. 88764.8.8

2



VOGEL auf Steinsäule ca. 60 cm hoch

Farbe: Black / White Art.-Nr. 90113.7
 Farbe: White / Purple Art.-Nr. 90113.8
 Farbe: Yellow Art.-Nr. 90113.9

3



VOGEL auf Steinsäule ca. 60 cm hoch

Farbe: Black / White Art.-Nr. 88233.7
 Farbe: White / Purple Art.-Nr. 88233.8
 Farbe: Yellow Art.-Nr. 88233.9

4



VOGEL auf Steinsäule ca. 60 cm hoch

Farbe: Black / White Art.-Nr. 990322.7
 Farbe: White / Purple Art.-Nr. 990322.8
 Farbe: Yellow Art.-Nr. 990322.9

5



EISVOGEL auf Steinsäule ca. 60 cm hoch

Farbe: Black / White Art.-Nr. 89003.7
 Farbe: White / Purple Art.-Nr. 89003.8
 Farbe: Yellow Art.-Nr. 89003.9

6



EISVOGEL auf Steinsäule ca. 50 cm hoch

Farbe: Black / White Art.-Nr. 89004.7
 Farbe: White / Purple Art.-Nr. 89004.8
 Farbe: Yellow Art.-Nr. 89004.9



1

RABE auf Steinsäule

ca. 60 cm hoch

Farbe: Black / White Art.-Nr. 89051.7
 Farbe: White / Purple Art.-Nr. 89051.8
 Farbe: Yellow Art.-Nr. 89051.9



2

EISVOGEL auf Steinsäule

ca. 60 cm hoch

Farbe: Black / White Art.-Nr. 88320.7
 Farbe: White / Purple Art.-Nr. 88320.8
 Farbe: Yellow Art.-Nr. 88320.9



3

EISVOGEL auf Steinsäule

ca. 60 cm hoch

Farbe: Black / White Art.-Nr. 88321.7
 Farbe: White / Purple Art.-Nr. 88321.8
 Farbe: Yellow Art.-Nr. 88321.9



4

RABE auf Steinsäule

ca. 60 cm hoch

Farbe: Black / White Art.-Nr. 89014.7
 Farbe: White / Purple Art.-Nr. 89014.8
 Farbe: Yellow Art.-Nr. 89014.9



5

FROSKÖNIG auf Steinsäule

ca. 60 cm hoch

Farbe: Black / White Art.-Nr. 90454.7
 Farbe: White / Purple Art.-Nr. 90454.8
 Farbe: Yellow Art.-Nr. 90454.9



6

FROSKÖNIG auf Steinsäule

ca. 60 cm hoch

Farbe: Black / White Art.-Nr. 89016.7
 Farbe: White / Purple Art.-Nr. 89016.8
 Farbe: Yellow Art.-Nr. 89016.9

BRUNNENKOMPLETTSETS inkl. PE-Becken, GFK-Deckel, Splitt, Pumpe & Quellelement



1

Froschkönig RATOMIR
H 72 cm, Ø 55 cm Art.-Nr. 994343



2

Froschkönig OTTO
H 55 cm, Ø 55 cm Art.-Nr. 994336



3

Froschkönig HEINRICH
H 55 cm, Ø 55 cm Art.-Nr. 994337



4

Brunnenkomplettset FINN
H 73 x B 66 x T 66 cm Art.-Nr. 994364



5

Brunnenkomplettset LEOPOLD
H 73 x B 66 x T 66 cm Art.-Nr. 994341



6

Brunnenkomplettset Quellstein mit Vogelpaar
H 70 x B 66 x T 66 cm Art.-Nr. 994365



7

Quellkammer mit Bronzevogel
H 65 cm, Ø 55 cm Art.-Nr. 994346



8

Quellkammer mit Eidechse
H 63 cm, Ø 55 cm Art.-Nr. 994344



9

Wasserfallstein mit Eidechse
H 65 cm, Ø 55 cm Art.-Nr. 994347



10

Wasserlauf mit Eisvogel klein
H 55 cm, Ø 55 cm Art.-Nr. 994345



1

Vogeltränke mit Vogelpaar klein
H 10 x B 20 x T 20 cm
Art.-Nr. 42064



2

Vogeltränke mit Bronze-Vogel
ca. H 10 x B 35 x T 30 cm
Art.-Nr. 42048



3

Vogeltränke Bronze-Froschkönig
ca. H 23 x B 24 x T 30 cm
Art.-Nr. 994353



4

Vogeltränke mit 2 Bronze-Vögeln
ca. H 15 x B 35 x T 30 cm
Art.-Nr. 42047



5

Vogeltränke mit Bronze-Eisvogel
ca. H 20 x B 25 x T 35 cm
Art.-Nr. 991351



6

Vogeltränke mit Bronze-Eisvogel
ca. H 10 x B 20 x T 20 cm
Art.-Nr. 42054

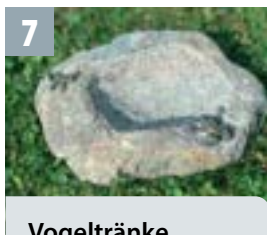

7

Vogeltränke mit Bronze-Frosch & Bronze-Eidechse
ca. H 10 x B 20 x T 25 cm
Art.-Nr. 994352



8

Vogeltränke mit Bronze-Eidechse
ca. H 10 x B 30 x T 25 cm
Art.-Nr. 994350



9

Vogeltränke mit Bronze-Eidechse
ca. H 12 x B 40 x T 30 cm
Art.-Nr. 994349



10

Vogeltränke mit Bronze-Eidechse
ca. H 10 x B 35 x T 30 cm
Art.-Nr. 994348



11

INSEKTENTRÄNKE mit Bronze-Libelle
ca. 10 x 20 x 20 cm
Art.-Nr. 42055



12

INSEKTENTRÄNKE mit Bronze-Schmetterling - Flügel geöffnet
ca. 10 x 20 x 20 cm Art.-Nr. 42056



13

INSEKTENTRÄNKE mit Bronze-Schmetterling - Flügel geschlossen
ca. 10 x 20 x 20 cm Art.-Nr. 42058



14

INSEKTENTRÄNKE mit Bronze-Biene
ca. 10 x 20 x 20 cm
Art.-Nr. 42057



15

Vogeltränke Herz mit Bronzefigur Eisvogel
Steinguss, ca. H 15 x B 31 x T 40 cm
Art.-Nr. 88001



16

Vogeltränke Blume mit Bronzefigur Vogel
Steinguss, ca. H 12 x B 33 x T 34 cm
Art.-Nr. 88002



17

Vogeltränke Herz mit Bronzefigur Vogel
Steinguss, ca. H 12 x B 31 x T 40 cm
Art.-Nr. 80003



18

Vogeltränke Blume mit Bronzefigur Vogel
Steinguss, ca. H 10 x B 31 x T 40 cm
Art.-Nr. 80004



19

Vogeltränke Duo mit Bronzefigur Eidechse
Steinguss, ca. H 8 x B 47 x T 30 cm
Art.-Nr. 80005



20

Vogeltränke Duo mit Bronzefigur Vogelpaar
Steinguss, ca. H 11 x B 47 x T 30 cm
Art.-Nr. 80006



21

Vogeltränke Natur mit Bronzefigur Schmetterling
Steinguss, ca. H 9 x B 25 x T 28 cm
Art.-Nr. 80007



22

Vogeltränke Natur mit Bronzefigur Schmetterling
Steinguss, ca. H 8 x B 25 x T 28 cm
Art.-Nr. 80008

FINDLINGS mit Bronze-Figuren



1 **Bronze-Eisvogel
Flügel offen
auf Granitsäule**
ca. H 28 x B 12 x T 9 cm
Art.-Nr. 89004.4

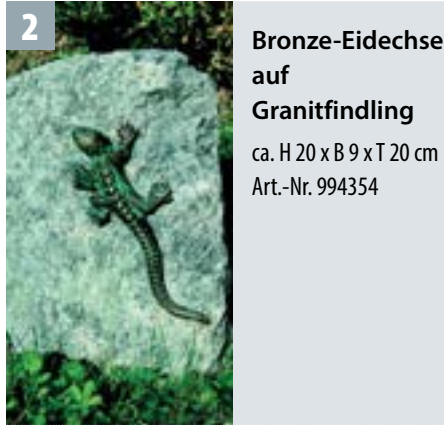

2 **Bronze-Eidechse
auf
Granitfindling**
ca. H 20 x B 9 x T 20 cm
Art.-Nr. 994354



3 **Bronze-Vogel
auf Granitsäule**
ca. H 30 x B 15 x T 9 cm
Art.-Nr. 991306



4 **Bronze-Eisvogel
Flügel zu
auf Granitsäule**
ca. H 28 x B 12 x T 9 cm
Art.-Nr. 89003.4



5 **Bronze-Vogel
auf
Granit-Findling**
ca. H 9 x B 15 x T 20 cm
Art.-Nr. 994340



6 **Bronze-Vogel
auf
Mond-Gestein**
ca. H 9 x B 15 x T 20 cm
Art.-Nr. 994338



7 **Bronze-Vogel
auf Saleph
(Sondermodell)**
ca. H 9 x B 20 x T 20 cm
Art.-Nr. 991323



8 **Bronze-Frosch
auf Findling**
ca. H 6 x B 10 x T 10 cm
Art.-Nr. 90325.10



9 **Bronze-Eidechse
auf Findling**
ca. H 8 x B 20 x T 25 cm
Art.-Nr. 99233
ca. H 7 x B 10 x T 14 cm
Art.-Nr. 90324.10



10 **Bronze-Eidechse
auf Schwarz-
wald Granit**
ca. H 8 x B 20 x T 15 cm
Art.-Nr. 991332



11 **Bronze-Eidechse
auf Kalkstein**
ca. H 9 x B 20 x T 18 cm
Art.-Nr. 991349



12 **Bronze-Gecko
auf
Mond-Gestein**
ca. H 7 x B 10 x T 12 cm
Art.-Nr. 991354



13 **Vogelpaar
klein
auf Alaskastein**
H 10 x B 2,3 x T 12 cm
Art.-Nr. 88086.1



14 **Bronze-
Schmetterling
klein
auf Findling**
ca. H 9 x B 15 x T 15 cm
Art.-Nr. 88725.1



15 **Bronze-
Schmetterling
auf Findling**
ca. H 9 x B 20 x T 20 cm
Art.-Nr. 88635.1



16 **Vogel
auf
Alaskastein**
H 20 x B 16 x T 15 cm
Art.-Nr. 90329



17 **Vogel
auf
Alaskastein**
H 12 x B 15 x T 15 cm
Art.-Nr. 90330



18 **Bronze-Vogel
auf
Granit-Findling**
ca. H 9 x B 20 x T 18 cm
Art.-Nr. 991333



1

Brunnenkugel
inkl. Pumpe und LED-
Beleuchtung, matt gebürstet
Ø 28 cm BKM100101
Ø 40 cm BKM100102
Ø 50 cm BKM100103
Ø 60 cm BKM100104
Ø 75 cm BKM100105



2

**3er Edelstahl-
Brunnenkugel**
inkl. Pumpe und LED-Beleuch-
tung u. Trafo, matt gebürstet
Ø 20/25/30 cm BK 100111
Ø 20/28/40 cm BK 100110
Ø 28/40/50 cm BK 100112



3

**Brunnenturm
„SYLT“
aus Edelstahl
matt gebürstet**
inkl. Pumpe
und LED-Beleuchtung

Art.-Nr. BKT 100102
Gesamtabmessung:
88 x 40 x 40 cm
einzelne Kugeln:
40 cm, 28 cm, 20 cm

Art.-Nr. BKT 100101
Gesamtabmessung:
73 x 28 x 28 cm
einzelne Kugeln:
28 cm, 25 cm, 20 cm



4

**Brunnenturm
„AMRUM“
aus Edelstahl
matt gebürstet**
inkl. Pumpe
und LED-Beleuchtung

Art.-Nr. BKT 100112
Gesamtabmessung:
100 x 40 x 40 cm
einzelne Kugeln:
40 cm, 28 cm, 20 cm

Art.-Nr. BKT 100111
Gesamtabmessung:
83 x 28 x 28 cm
einzelne Kugeln:
28 cm, 25 cm, 20 cm



5



Wasserfall MAMBO
Edelstahl matt gebürstet inkl. LED-Beleuchtung & Trafo,
Anschlüsse 1 Zoll unten & hinten,
Lieferumfang inkl. 1 Anschlussstutzen sowie 1 Blindstopfen

Tiefe: 34 cm, Höhe 14 cm 30 cm: WFM 100385 45 cm: WFM 100386 60 cm: WFM 100387



6

Wasserfälle aus Edelstahl und Cortenstahl inkl. LED-Beleuchtung

Tiefe 16,5 cm, Höhe 8,5 cm, Auslaufkante ca. 10 cm

	matt-gebürstet	poliert	Cortenstahl
30 cm	WFM 100351	WFP 100371	WFC 100391
45 cm	WFM 100352	WFP 100372	WFC 100392
60 cm	WFM 100353	WFP 100373	WFC 100393
75 cm	WFM 100354	WFP 100374	WFC 100394
90 cm	WFM 100355	WFP 100375	WFC 100395



7

**Wasserfall aus Edelstahl
matt gebürstet
mit abgeschrägter Auslauflippe**
inkl. LED-Beleuchtung
T 30 cm, H 8,5 cm, Tiefe Lippe/Auslauf ca. 22 cm
30 cm WFM 100375
45 cm WFM 100376
60 cm WFM 100377



8

**Wasserfall aus Cortenstahl
mit abgeschrägter Auslauflippe**
inkl. LED-Beleuchtung
T 30 cm, H 8,5 cm, Tiefe Lippe/Auslauf ca. 22 cm
30 cm WFC 100385
45 cm WFC 100386
60 cm WFC 100387

TERRASSENBRUNNEN, WASSERWÄNDE UND QUELLKUGELN

– Komplettes Sortiment siehe Edelstahl-Katalog –



1

Terrassenbrunnen BORKUM
Kugel, Edelstahl matt gebürstet ca. 23 cm, Becken Polystone anthrazit ca. 40/20 cm, inkl. Pumpe, LED-Beleuchtung & 1 Beutel Zierkies weiß

Art.-Nr. WS100501



2

Terrassenbrunnen MADRID
Edelstahl mit Graphitbeschichtung in anthrazit inkl. Pflanzkasten, Pumpe & LED-Beleuchtung

MADRID klein
89 x 46 x 44 cm Art.-Nr. WS100402

MADRID groß
89 x 72 x 44 cm Art.-Nr. WS100400



3

Terrassenbrunnen NORDERNEY
Kugeln Edelstahl matt gebürstet 25/20/15 cm Becken Polystone anthrazit ca. 45/20 cm Gesamthöhe ca. 80 cm inkl. Pumpe, LED-Beleuchtung & 1 Beutel Zierkies weiß

Art.-Nr. WS 100502



4

Terrassenbrunnen FÖHR
Kugeln Edelstahl matt gebürstet 15/20/15 cm Becken Polystone anthrazit ca. 45/20 cm Gesamthöhe ca. 70 cm inkl. Pumpe, LED-Beleuchtung & 1 Beutel Zierkies weiß

Art.-Nr. WS 100503



5

Wasserwand HUSUM
Edelstahl matt-gebürstet oder Cortenstahl, inkl. Pumpe & LED-Strahler

HUSUM klein
130 x 45 x 6 cm
Art.-Nr. WW100104 Edelstahl
Art.-Nr. WW100114 Cortenstahl

HUSUM groß
180 x 50 x 6 cm
Art.-Nr. WW100103 Edelstahl
Art.-Nr. WW100113 Cortenstahl



6

Wasserwand DALUM
Edelstahl matt-gebürstet oder Cortenstahl, inkl. Pumpe & LED-Strahler

DALUM klein
130 x 45 x 6-20 cm
Art.-Nr. WW100102 Edelstahl
Art.-Nr. WW100112 Cortenstahl

DALUM groß
180 x 50 x 6-25 cm
Art.-Nr. WW100101 Edelstahl
Art.-Nr. WW100111 Cortenstahl



7

Säulenbrunnen eckig 10 x 10 cm, 2 versch. Materialien
inkl. Pumpe und LED-Beleuchtung

	matt-gebürstet	Cortenstahl
H 40 x 10 cm	SB 100235	SB 100245
H 60 x 10 cm	SB 100236	SB 100246
H 80 x 10 cm	SB 100237	SB 100247
H 100 x 10 cm	SB 100238	SB 100248



8

Säulenbrunnen eckig 20 x 20 cm, 2 versch. Materialien
inkl. Pumpe und LED-Beleuchtung

	matt-gebürstet	Cortenstahl
H 40 x 20 cm	SB 100263	SB 100273
H 60 x 20 cm	SB 100260	SB 100270
H 80 x 20 cm	SB 100261	SB 100271
H 100 x 20 cm	SB 100262	SB 100272



Alle Wasserspiele in Edelstahl matt gebürstet und Cortenstahl erhältlich.

1



**Wasserspiel
Future
(Ellipse eckig)**

Größen:
H 100 x B 42 x T 21 cm
Wasseraustritt 2
H 125 x B 60 x T 31 cm
Wasseraustritt 4
H 150 x B 74 x T 36 cm
Wasseraustritt 6
H 175 x B 88 x T 42 cm
Wasseraustritt 6
H 200 x B 100 x T 58 cm
Wasseraustritt 6

2



**Wasserspiel
Noblese (Ellipse)**

Größen:
H 60 x B 25 x T 13 cm
Wasseraustritt 2
H 80 x B 34 x T 17 cm
Wasseraustritt 2
H 100 x B 42 x T 21 cm
Wasseraustritt 2
H 125 x B 60 x T 31 cm
Wasseraustritt 4
H 150 x B 74 x T 36 cm
Wasseraustritt 6
H 175 x B 88 x T 42 cm
Wasseraustritt 6
H 200 x B 100 x T 58 cm
Wasseraustritt 6

3

Bodenwannen für Wasserspiel Future und Wasserspiel Noblese

Größen: 100 cm = B 70 x T 50 x H 20 cm / 125 cm = B 85 x T 60 x H 20 cm / 150 cm = B 100 x T 70 x H 20 cm / 175 cm = B 110 x T 80 x H 20 cm
200 cm = B 120 x T 85 x H 25 cm

4



**Wasserspiel
Obelisk (Säule)**

Größen:
L 25 x B 25 x H 125 cm
L 25 x B 25 x H 150 cm
L 25 x B 25 x H 175 cm
L 25 x B 25 x H 200 cm
Wasseraustritt: 1

Bodenwanne

Größe:
B 60 x T 60 x H 20 cm



5



**Edelstahlsäule
eckig**

2 mm,
Kanten geschliffen
verschweißt

SET 1:

H 80/ 60/ 40 cm
x B 15 x T 15 cm

SET 2:

H 100/ 80/ 60 cm
x B 15 x T 15 cm

SET 3:

H 110/ 95/ 80 cm
x B 15 x T 15 cm

Auch einzelne Säulen
möglich



Wasserspiel WAVE inkl. Pumpe

Der Wasserablauf ist vorne.
Die Welle ist hinten geschlossen.
Die Verrohrung ist nicht sichtbar.
Brunnenkörper und Becken
sind fest verschweißt.

1.) Wave 120:
Höhe 120 cm,
Breite 50 cm,
Tiefe 25 cm
Becken:
B 70 x H 20 x T 50 cm
Art.-Nr. WWA 120

2.) Wave 160:
Höhe 160 cm,
Breite 65 cm,
Tiefe 25 cm
Becken:
B 85 x H 20 x T 60 cm
Art.-Nr. WWA 160

3.) Wave 200:
Höhe 200 cm,
Breite 85 cm,
Tiefe 25 cm
Becken:
B 100 x H 20 x T 70 cm
Art.Nr. WWA 200



2



Edelstahl-Brunnenkugel mit Gewindeanschluss matt gebürstet und poliert

ES-B
Größe: Ø 20 cm
Ø 25 cm

ES-B LED
Ø 30 cm
Ø 35 cm
Ø 40 cm
Ø 48 cm
Ø 58 cm
Ø 75 cm

große Bohrung für LED

3



Brunnenkugel „Profi“ aus Cortenstahl 2 mm mit Verrohrung für LED-Beleuchtung

CO-B 30 Ø 30 cm, 4 kg
CO-B 40 Ø 40 cm, 9,5 kg
CO-B 48 Ø 48 cm, 13 kg
CO-B 58 Ø 58 cm, 19 kg
CO-B 75 Ø 75 cm, 28 kg

4



SCHWEBENDER CUBO inkl. Quellstar 900 – optional und/oder ergänzend Aqualine Rondo 30

L 40 x B 40 x H 60 cm Art.-Nr. SWCU40

L 50 x B 50 x H 70 cm Art.-Nr. SWCU50

L 60 x B 60 x H 80 cm Art.-Nr. SWCU60

5



Abbildung:
matt gebürstet



Abbildung:
Cortenstahl

Wasserspiel CUBO

Größen	Art.-Nr.
L 40 x B 40 x H 40 cm	WCU40
L 50 x B 50 x H 50 cm	WCU50
L 60 x B 60 x H 60 cm	WCU60
L 70 x B 70 x H 70 cm	WCU70
L 80 x B 80 x H 80 cm	WCU80

1



B 66 HD	Ø 66 cm	H 33 cm	90 l
B 90 HD	Ø 90 cm	H 33 cm	150 l
B 90 X-tra	Ø 90 cm	H 60 cm	285 l
B 120 HD	Ø 120 cm	H 33 cm	280 l
B 120 HD X	Ø 120 cm	H 61 cm	475 l
B 150	Ø 150 cm	H 35 cm	450 l
B 150 X-tra	Ø 150 cm	H 60 cm	750 l
B 170	Ø 170 cm	H 35 cm	525 l
B 170 X-tra	Ø 170 cm	H 61 cm	900 l
B 220 X-tra	Ø 220 cm	H 60 cm	1.600 l

2



APE 66 HD	Ø 66 cm	350 kg
APE 90 HD	Ø 90 cm	450 kg
APE 120 HD	Ø 120 cm	550 kg
APE 150	Ø 150 cm	500 kg
APE 170	Ø 170 cm	400 kg
APE 220	Ø 220 cm	500 kg

5



GFK-Rechteckbecken

B 80/60	L 80 x B 60 cm	H 35 cm	100 l
B 120/80	L 120 x B 80 cm	H 35 cm	260 l
B 120/80/60	L 120 x B 80 cm	H 60 cm	450 l
B 140/70	L 140 x B 70 cm	H 30 cm	260 l
B 140/70/60	L 140 x B 70 cm	H 60 cm	500 l
B 200/100	L 200 x B 100 cm	H 35 cm	550 l
B 200/100/60	L 200 x B 100 cm	H 60 cm	800 l
B 240/120/35	L 240 x B 120 cm	H 35 cm	800 l
B 240/120/60	L 240 x B 120 cm	H 60 cm	1.400 l
B 240/120/100	L 240 x B 120 cm	H 100 cm	2.200 l

7



Winkelbecken

B 140/70/140/70	140 x 70 x 140 x 70 cm	H 35 cm	350 l
B 240/120/240/120	240 x 120 x 240 x 120 cm	H 35 cm	1.050 l

9



PE-Becken

BPE 45	Ø 44 cm	H 30 cm	30 l
BPE 55	Ø 55 cm	H 32 cm	45 l
BPE 60	Ø 59 cm	H 34 cm	65 l
BPE 66	Ø 67 cm	H 37 cm	90 l
BPE 90	Ø 88 cm	H 32 cm	150 l
BPE 110	Ø 110 cm	H 35 cm	275 l
BPE 230 X-tra	Ø 85 cm	H 65 cm	230 l
BPE 750 X-tra	Ø 122 cm	H 82 cm	750 l

3



B 70/70	70 x 70 cm	H 30 cm	110 l
B 70/70/60	70 x 70 cm	H 60 cm	220 l
B 100/100	100 x 100 cm	H 35 cm	200 l
B 120/120	120 x 120 cm	H 35 cm	350 l
B 150/150	150 x 150 cm	H 35 cm	735 l
B 220/220	220 x 220 cm	H 45 cm	2.000 l

4



A 70/70	70 x 70 cm	200 kg	A 80/60	80 x 60 cm	200 kg
A 100/100	100 x 100 cm	200 kg	A 120/80	120 x 80 cm	300 kg
A 120/120	120 x 120 cm	400 kg	A 140/70	140 x 70 cm	400 kg
A 150/150	150 x 150 cm	500 kg	A 200/100	200 x 100 cm	500 kg
A 220/220	220 x 220 cm	500 kg	A 240/120	240 x 120 cm	500 kg

6



Segment-Becken

SBE 090	L 90 x B 90 x T 87 cm	100 l	¼ Becken aus 170 cm
----------------	-----------------------	-------	---------------------

8



GFK-Halbrundbecken

B092	L 90 x B 73 x T 35 cm	100 l
B122	L 120 x B 94 x T 35 cm	200 l

GFK-Halbrunddeckel

D092	Ø 90 x 73 cm
D122	Ø 120 x 94 cm

10



Abdeckplatte

APE 45 HD	Ø 45 cm	200 kg
APE 55 HD	Ø 55 cm	250 kg
APE 60 HD	Ø 60 cm	300 kg
APE 66 HD	Ø 66 cm	350 kg
APE 90 HD	Ø 90 cm	450 kg
APE 230 X-tra	Ø 90 cm	450 kg
APE 750 X-tra	Ø 120 cm	550 kg

1

**GFK-Lastenträger**

Traglast max. 1.200 kg

SB 26 H 26 cm,
für B 70/70 / B 110/110**SB 30** H 29 cm,
für BPE 110,
B 150, 170,
130/130, 150/150

2

**Fiberglas-Lastenträger**Traglast max. 2.500 kg,
für HD Becken**SB 90 / 120 HD**
H 28 cm

3

**Fiberglas-Lastenträger**Traglast max. 2.000 kg,
für PE-Becken**ST 025001**
H 25 cm, Ø 50 cm

4

**Fiberglas-Lastenträger**

für GFK-Becken 60 cm tief

SB 120 X-tra HD
H 56 cm, Ø 50 cm

5

**Kreuzstütze für PE-Becken**Traglast max. 1.000 kg,
für PE-Becken Ø 66 cm**KST 06601**
H 30 cm, Ø 30 cm

6

**Fiberglas-Lastenträger**für handlamierte
GFK-Becken 35 cm**ST 028001 ADAP**
H 33 cm, Ø 50 cm

7

**PE-Gitternetz für GFK-Deckel und Gitterrost**

Maschenweite 6 x 6 mm

GN06600 Ø 46 cm
geeignet für Abdeckplatte & Gitterrost 66 cm**GN09000** Ø 72 cm
geeignet für Abdeckplatte & Gitterrost 90 cm**GN12000** Ø 99 cm
geeignet für Abdeckplatte & Gitterrost 120 cm

8

**GFK-Beckenumrandung rund**

Erhältlich in den Farben:

Cortenstahloptik = C, Granitgrau = G**BUG 66** Ø 68 H 38 cm**BUG 90** Ø 92 H 38 cm**BUG 120** Ø 122 H 38 cm

1



Schlauchschelle Chromstahl

Bandbreite 9 mm

GP041050	blau	3/8 Zoll
GP041075	grün	1/2 Zoll
GP041100	gelb	3/4 Zoll
GP041125	orange	1 Zoll
GP041150	rot	1 1/4 Zoll
GP041175	schwarz	1 1/2 Zoll

2



Spiralschlauchschellen

Doppeldraht Spannbereich

GP040050	blau	8 – 12 mm
GP040075	grün	12 – 22 mm
GP040100	gelb	20 – 25 mm
GP040125	orange	24 – 32 mm
GP040150	rot	32 – 40 mm
GP040175	schwarz	37 – 45 mm

3



Gummimanschette

zum Fixieren vom Schlauch in Wasserspielen.

Größe: 1/2 Zoll, 3/4 Zoll

4



Spiralschlauch Standard

Größe: 1/2, 3/4, 1, 1 1/4, 1 1/2, 2 Zoll
Rolle 30 m

Profi-Spiralschlauch

Größe: 3/4, 1, 1 1/4, 1 1/2, 2 Zoll
Rolle 25 m

5



3-Wege-Wasserventil

Art.-Nr. 40275

- passend für folgende Schlauchanschlüsse: 1/2 Zoll, 3/4 Zoll, 1 Zoll
- Ø Bohrung: 80 mm

6



Absperrhähne / Regulierhähne

Art.-Nr. PP002220	13 x 13 mm
Art.-Nr. PP002260	19 x 19 mm
Art.-Nr. PP002280	25 x 25 mm

7



Absperrventil

Art.-Nr. 40274

- passend für folgende Schlauchanschlüsse: 1/2 Zoll, 3/4 Zoll, 1 Zoll
- Ø Bohrung: 30 mm

8



Y-Verteiler mit Regulierhähnen

Art.-Nr. AZ 056011	20 und 25 mm
Art.-Nr. AZ 056021	25, 32 und 38 mm
Art.-Nr. AZ 056031	32, 40 und 50 mm

9

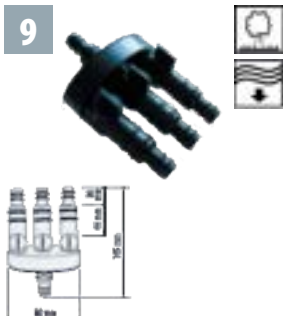

3-Wege-Wasserverteiler

Art.-Nr. 40881

- Anschlüsse: 1/2 Zoll, 3/4 Zoll
- Stufenlos 3fach regulierbar

Abmessungen: B 88 x H 135 mm
Abmessungen Stutzen 1/2 Zoll: Ø 1/2 Zoll x 20 mm
Abmessungen Stutzen 3/4 Zoll: Ø 3/4 Zoll x 44 mm

10



Y-Verteiler

Art.-Nr. PK 035100
Anschlüsse: 1 Zoll

11

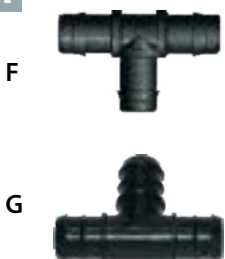

T-Stück

F Art.-Nr. PP001300	6 x 6 x 6 mm
F Art.-Nr. PP001320	10 x 10 x 10 mm
F Art.-Nr. PP001330	13 x 13 x 13 mm
F Art.-Nr. PP001340	16 x 16 x 16 mm
F Art.-Nr. PP001350	19 x 19 x 19 mm
F Art.-Nr. PP001360	25 x 25 x 25 mm
F Art.-Nr. PP001380	32 x 32 x 32 mm
G Art.-Nr. PK032150	38 x 38 x 38 mm

12



Reduzierstück

Art.-Nr. PP002000	10 x 6 mm
Art.-Nr. PP002020	13 x 6 mm
Art.-Nr. PP002060	16 x 13 mm
Art.-Nr. PP002070	19 x 13 mm
Art.-Nr. PP002080	19 x 16 mm
Art.-Nr. PP002100	25 x 13 mm
Art.-Nr. PP002120	25 x 19 mm
Art.-Nr. PP002140	32 x 25 mm

1

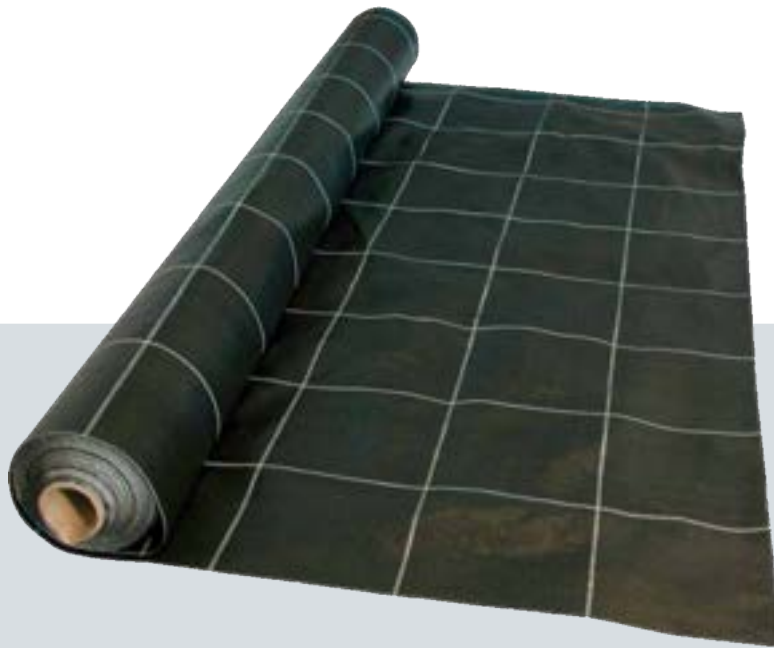
**Wurzelfolie**

100 x 2,10 m

100 x 1,05 m

2



Header pool

Medium
water course

Large water course



Small water course

**Bachlaufelemente****Header pool**

Art.-Nr. BLE-HP 65 x 59 cm

Small water course

Art.-Nr. BLE-S 65 x 40 cm

Medium water course

Art.-Nr. BLE-M 95 x 44 cm

Large water course

Art.-Nr. BLE-L 108 x 46 cm

3

**Rhizomsperre**

Maße 25 x 0,7 m,

2 mm stark

Art.-Nr. RS70/25

Maße 50 x 0,7 m,

2 mm stark

Art.-Nr. RS70/50

4

**Alu-Verbindungsschiene
für Rhizomsperre**

70 cm, 7 Schrauben

Art.-Nr. KS70

1



Pflanzkorb

Art.-Nr. WPK11 11 x 11 x 11 cm
 Art.-Nr. WPK19 19 x 19 x 9 cm
 Art.-Nr. WPK23 23 x 23 x 13 cm
 Art.-Nr. WPK28 28 x 28 x 18 cm
 Art.-Nr. WPK35 35 x 35 x 26 cm

Art.-Nr. WPK13 Ø 13 x 10 cm
 Art.-Nr. WPK22 Ø 22 x 12 cm
 Art.-Nr. WPK40 Ø 40 x 28 cm

Art.-Nr. WPK Niere 45 x 18 x 15 cm

2



Einlegetuch

Art.-Nr. ET45
 45 x 45 cm

3



Teichkescher 110 B

90 cm Stiellänge
 25 x 17 cm Netz
 schwarz, grobmaschig

4



Teichkescher 120 B

93 cm Stiellänge
 schwarz, grobmaschig
 Ø 25 cm Netz



Teichkescher 110 W

90 cm Stiellänge
 25 x 17 cm Netz
 weiß, feinmaschig

5



Netz R 35 B
 Ø 35 cm
 schwarz, grobmaschig

Netz R 35 W
 Ø 35 cm
 weiß, feinmaschig

6



Netz 45 x 45 B
 45 x 45 x 45 cm
 schwarz, grobmaschig

Netz 45 x 45 W
 45 x 45 x 45 cm
 weiß, feinmaschig

7



Aluminium-Teleskopstange

115 - 210 cm, ausziehbar

Aluminiumstange

115 cm

8



Teichzange

125 cm Stiellänge

Teichschere

125 cm Stiellänge



Energieverteiler mit Erdspeiß
1,5 m Anschlusskabel inkl. Stecker, 3680 Watt, IP44

Ausführung

2-fach	Art.-Nr. 35466
2-fach mit Timer	Art.-Nr. 35465
2-fach mit Fernbedienung	Art.-Nr. 35469
3-fach	Art.-Nr. 35467
4-fach	Art.-Nr. 35468



AC Control
4-fach Energieverteiler mit Funkfernbedienung

4 separat schaltbare Steckdosen,
verschraubbare Abdeckung und Erdspeiß,
10 m Anschlusskabel

Maße: H 160 x 190 x 245 mm
Art.-Nr. HP040004



Nebelgerät Fogstar 300
für den Außenbereich

inkl. Netzgerät Art.-Nr. 41030

Technische Daten:

Spannung: 36 V, Leistung: 100 VA
IP68, Kabel: 10 m
Gehäuse: Edelstahl

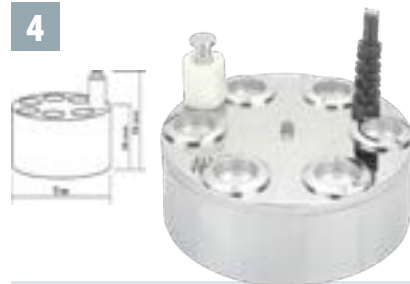

Nebelgerät Fogstar 600
für den Außenbereich

inkl. Netzgerät Art.-Nr. 41040

Technische Daten:

Spannung: 36 V, Leistung: 230 VA
IP68, Kabel: 10 m
Gehäuse: Edelstahl



Ersatzmembrane
3er-Set

Art.-Nr.: 40030
Ø 20 mm



Schwimmringe

passend für Fogstar
300 Maße: Ø 20 x Ø 9 cm
Art.-Nr. 41360
600 Maße: Ø 25 x Ø 13,5 cm
Art.-Nr. 41361



Brunnen- & Nebler-Spezial

Biologisch abbaubar
Für sauberes und hygienisches Wasser
im Innen- und Außenbereich
Art.-Nr. 59050
Inhalt 0,5 l Konzentrat

Pumpentechnik für den Außenbereich

SP-Pumpe

Unsere SP-Pumpen lassen Ihren Gartenteich lebendig werden. Ob Fontäne, Quellstein oder große Wasserspiele, die SP-Pumpen sind absolute Allrounder.

1



Pumpe	Leistung	Leistungs-aufnahme	Förder-höhe	Kabel-länge
WP350	350 (l/h)	6 Watt	0,7 m	5 m
WP450	450 (l/h)	5 Watt	0,95 m	5 m
WP650	650 (l/h)	8 Watt	1,10 m	5 m / 10 m
WP750	750 (l/h)	11 Watt	1,40 m	5 m / 10 m
SP1000	1000 (l/h)	14 Watt	1,80 m	10 m
SP1500	1500 (l/h)	25 Watt	2,00 m	10 m
SP2000	2000 (l/h)	35 Watt	2,50 m	10 m
SP2500	2500 (l/h)	45 Watt	3,00 m	10 m
SP3000	3000 (l/h)	60 Watt	2,80 m	10 m
SP4000	4000 (l/h)	75 Watt	2,90 m	10 m
SP5000	5000 (l/h)	98 Watt	3,60 m	10 m

JSP-Pumpe

Die Asynchronmotorpumpe mit Vortex Freistromlaufrad für Bachläufe und Filteranlagen.

- energiesparender Spaltrohrmotor
- Vortex Freistromlaufend
- überlastungsgeschützt durch Thermoschalter
- trocken aufstellbar
- große Vorfilterkappen
- verlängerte Reinigungsintervalle durch optimalen Wasserfluss
- schmutzwassergeeignet bis Korngröße 6 mm
- wartungsfreundlich durch entnehmbare Laufeinheit
- dauerlauffest durch verschleißfreie Keramiklagerung
- alle spannungsgeladenen Teile völlig in Harz vergossen

2



Pumpe	Leistung	Leistungs-aufnahme	Förder-höhe	Druckan-schluss	Saugan-schluss	Anschluss-kabel
JSP3000	3000 (l/h)	35 Watt	2,50 m	1"	1"	10 m
JSP4500	4500 (l/h)	65 Watt	3,00 m	1"	1"	10 m
JSP8000	3000 (l/h)	125 Watt	4,00 m	1"	1 1/4"	10 m
JSP10000	10000 (l/h)	135 Watt	4,50 m	1"	1 1/4"	10 m
JSP12000	12000 (l/h)	175 Watt	5,00 m	1"	1 1/4"	10 m

3



Art.-Nr. 40498

seliger® 2200 A

- Fördermenge max. 2.200 Liter
- Adapterset - 22,5 mm
- Umfangreiches Düsen-set

Magnetkreislumpe

Versorgungsspannung: 230 V
 Leistungsaufnahme: 28 W
 Zuleitung: 10 m
 Fördermenge: 2.200 Liter
 Förderhöhe: 220 cm

5



Art.-Nr. 40384

Pumpe 400 A

- Inhalt:**
- seliger® Pumpe 400 A
 - Netzgerät 10 W

Technische Daten

Fördermenge in l/h: 400
 Förderhöhe: 97 cm
 Schutzart Pumpe: IP 68
 Netzgerät: 12 V / AC · 10 W · IP 44
 Leistungsaufnahme: 5,5 W
 Zuleitung: 10 m
 Zubehör: Verschiedene Adapter



4



Art.-Nr. 40473

seliger® 2800 A

- Fördermenge max. 2.800 Liter
- Adapterset - 22,5 und 39 mm
- Umfangreiches Düsen-set

Magnetkreislumpe

Versorgungsspannung: 230 V
 Leistungsaufnahme: 45 W
 Zuleitung: 10 m
 Fördermenge: 2.800 Liter
 Förderhöhe: 260 cm

1



SET

**Aquafall** (10 cm Auslaufkante)

Art.-Nr. 46200 · Länge: 300 mm

Art.-Nr. 46210 · Länge: 600 mm

Art.-Nr. 46220 · Länge: 900 mm

Art.-Nr. 46230 · Länge: 1200 mm

Art.-Nr. 46240 · Länge: 1500 mm

ÜBERSICHT 1" ANSCHLÜSSE • DIAGRAM 1" CONNECTIONS

Anschluss 1 Zoll	Aquafall 300	Aquafall 600	Aquafall 900	Aquafall 1200	Aquafall 1500
Hinten · Backside	1	1	2	3	4
Unten · Downside	1	1	2	3	4
benötigter Y Adapter 46205 · required Y adapter 46205			1	2	3

LEISTUNGSTABELLE FÜR EDELSTAHLWASSERFÄLLE* • PERFORMANCE TABLE FOR STAINLESS STEEL WATERFALLS*

Aquafall 300	Aquafall 600	Aquafall 900	Aquafall 1200	Aquafall 1500	Höhe · Height
ab 6.000 l	ab 8.000 l	ab 10.000 l	ab 15.000 l	ab 20.000 l	1,50 m
ab 4.000 l	ab 6.000 l	ab 8.000 l	ab 10.000 l	ab 15.000 l	1,00 m
ab 2.000 l	ab 3.000 l	ab 5.000 l	ab 5.000 l	ab 8.000 l	0,50 m

2

**LED-Leiste für Aquafall
(inkl. Trafo)****Inhalt**

- LED-Leiste für Edelstahlwasserfall (warmweiß)
- Netzgerät 10 W/20 W

Anwendung

- Einsatz in Wasserfällen
- Ausleuchten von Wasserspielen
- Wegbeleuchtung (begehbar)
- Objektbeleuchtung

Art.-Bezeichnung Art. designation	Art.-Nr. Art. no.	Abstrahlwinkel Beam angle	Farbe Color	Kelvin Kelvin	Lumen Lumens	EEK EEC	Gesamtverbrauch Total Consumption	LED LED
Aqualine 300	46500	120°	■	2900-3100	205	A+	2,7 W	2,5 W
Aqualine 600	46510	120°	■	2900-3100	440	A+	5,3 W	5,0 W
Aqualine 900	46520	120°	■	2900-3100	650	A+	7,9 W	7,5 W
Aqualine 1200	46530	120°	■	2900-3100	880	A+	10,5 W	10,1 W
Aqualine 1500	46540	120°	■	2900-3100	1140	A	13,2 W	12,6 W

1



Aqualine LED (ohne Trafo)

- Art.-Nr. 46501: Aqualine 300 LED · Länge 296 mm
- Art.-Nr. 46511: Aqualine 600 LED · Länge 596 mm
- Art.-Nr. 46521: Aqualine 900 LED · Länge 896 mm
- Art.-Nr. 46531: Aqualine 1200 LED · Länge 1200 mm
- Art.-Nr. 46541: Aqualine 1500 LED · Länge 1500 mm



Anwendung

- Einsatz in Wasserfällen
- Terrassen- und Wegeleuchtung
- Steg- und Stufenbeleuchtung
- Objektbeleuchtung

Inhalt:

- LED Leiste (warmweiß)

HAUPTMERKMALE

- LED-Beleuchtung für stimmungsvolle Effekte
- Aus hochwertigem Edelstahl (V2A)
- Vollverguss-LED-Einheiten
- Für den Innen- und Außenbereich
- Hochwertiges Befestigungsmaterial für den universellen Einsatz
- 2 Jahre Garantie
- Großes Zubehörsortiment

2



Halteclip

Art.-Nr. 46550

Inhalt:

- Halteclip

6

Verbindungskabel für Aqualine

- Art.-Nr. 911001 1 m
- Art.-Nr. 911002 2,5 m
- Art.-Nr. 911005 5 m
- Art.-Nr. 911010 10 m



3



Multifunktionsfuß

Art.-Nr. 46525

Inhalt:

- Multifunktionsfuß

7

Edelsthalterung und Einbauschiene für Aqualine



- Art.-Nr. 46202: Aqualine 300
- Art.-Nr. 46212: Aqualine 600
- Art.-Nr. 46222: Aqualine 900

- Art.-Nr. 46232: Aqualine 1200
- Art.-Nr. 46242: Aqualine 1500

4



Erdspeiß

Art.-Nr. 40526

Inhalt:

- Erdspeiß

5



Wandbefestigungsclip

Art.-Nr. 46560

Inhalt:

- 2 Wandbefestigungsclips
- Befestigungsset

8



Netzgerät 20 W

Art.-Nr. 40166

Aquaspot 12 V



Art.-Bezeichnung	Art.-Nr.	Abstrahlwinkel	Farbe	Kelvin	Lumen	EEK	Gesamtverbrauch	LED
Aquaspot 100 Power LED	40621	40°	☐	2900-3300	60-70	A	5 W	3 W
Aquaspot 300 Power LED	40640	40°	☐	2900-3300	60-70	A	15 W	3 x 3 W
Aquaspot Erweiterungsset	40620	40°	☐	2900-3300	60-70	A	5 W	3 W



1 Aquaspot 100 Power LED Art.-Nr. 40621
Lieferumfang: Strahler, Zuleitung à 5 m, Erdspieß, Montagefuß mit Schelle, Steckernetzgerät 10 W



2 Aquaspot 300 Power LED Art.-Nr. 40640
Lieferumfang: 3x Strahler, 3 x 5 m Zuleitung, 3x Erdspieß, 3x Montagefuß mit Schelle, Steckernetzgerät 20 W, 3er-Verteiler

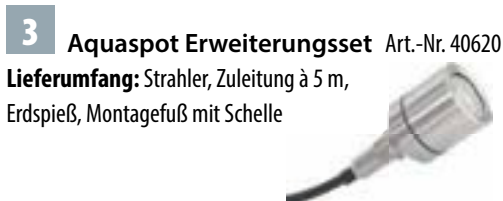

3 Aquaspot Erweiterungsset Art.-Nr. 40620
Lieferumfang: Strahler, Zuleitung à 5 m, Erdspieß, Montagefuß mit Schelle



Aquaspot 100 Halogen Art.-Nr. 40610
Lieferumfang: Unterwasserstrahler, Montagefuß mit Schelle, Erdspieß, Zuleitung à 5 m, Netzgerät 20 W



Aquaspot 300 Halogen Art.-Nr. 40630
Lieferumfang: 3 x Unterwasserstrahler, 3 x Montagefuß mit Schelle, 3 x Erdspieß, 3 x Zuleitung à 5 m, ein 3fach-Verteiler, ein Netzgerät 60 W



Aquaspot 100 Halogen Erweiterungssatz Art.-Nr. 40600
Lieferumfang: Unterwasserstrahler, Montagefuß mit Schelle, Erdspieß, Zuleitung à 5 m

7 Ersatzleuchtmittel Art.-Nr. 40168
Lieferumfang: 12 V Halogen, 20 W, 2er-Set



Merkmale

12 V AC	IP 68	LED	III
MS +NI	120°		
d			-25 °C +40 °C

Technische Zeichnungen

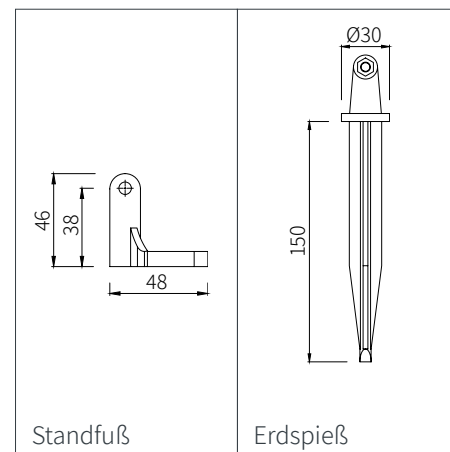
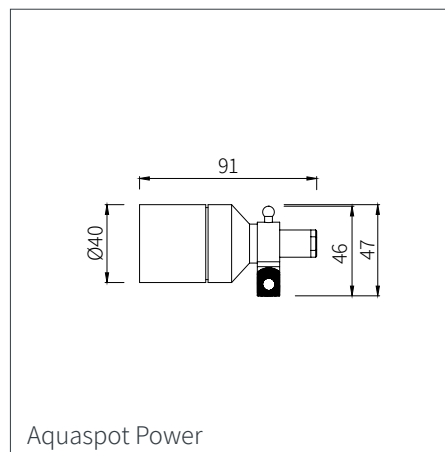





Aqualight 24V Set

Art.-Bezeichnung	Art.-Nr.	Abstrahlwinkel	Farbe	Kelvin	Lumen	EEK	Gesamtverbrauch	LED
Aqualight 100	360001	40°	☐	2900-3100	107	A	4 W	3 W
Aqualight 300	360003	40°	☐	2900-3100	107	A	12 W	3 x 3 W

1  **Aqualight 100** Art.-Nr. 360001
Lieferumfang:
Leuchteinheit, Erdspieß,
Spezienschlüssel, Zuleitung IP 68 à 5 m,
Steckernetzgerät 12 W

2  **Aqualight 300** Art.-Nr. 360003
Lieferumfang:
3x Leuchteinheit, 3x Erdspieß,
Spezienschlüssel,
Zuleitung IP 68 à 5 m,
2x Verbindungskabel IP 68 à 5 m,
Steckernetzgerät 24 W

3  **Aqualight Leuchteinheit** Art.-Nr. 360000
Zubehör optional
Art.-Nr. 40526 Erdspieß
Art.-Nr. 40525 Multifunktionsfuß
Art.-Nr. 40529 Ast- und Düsenhalterung

4  **Verbindungskabel Aqualight**
Länge 1 m Art.-Nr. 40527
Länge 2,5 m Art.-Nr. 40521
Länge 5 m Art.-Nr. 40522
Länge 10 m Art.-Nr. 40523
· Anschlüsse: IP 68/IP 68
· für die Vernetzung mehrerer Aqualights

5  **Anschlusskabel Netzgerät Aqualight**
Länge 5 m Art.-Nr. 361010
Länge 10 m Art.-Nr. 360011
· Anschlüsse: IP 68
· für die Vernetzung Aqualight zu Netzgerät

Merkmale

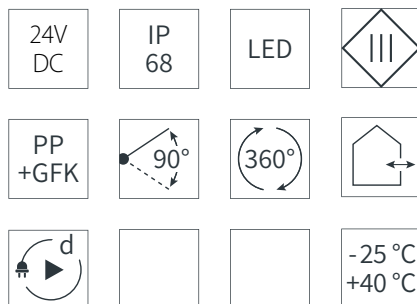

Technische Zeichnungen

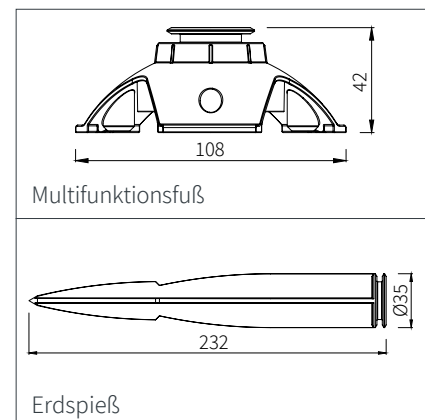
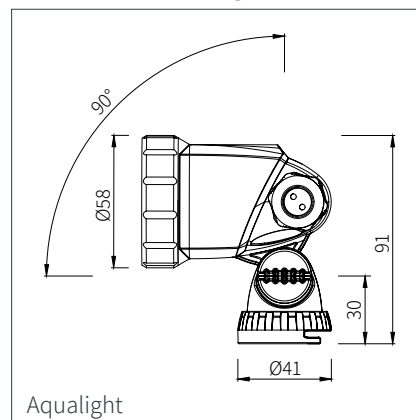

NETZGERÄTE

Kompatibel und passend für alle
Lichtsysteme.



Unsere Netzgeräte sind **GS geprüft** und haben mit **IP 44** die Zulassung für den Außenbereich.



Art.-Nr. 40255

Netzgerät 10 W
· Schutzart IP 44

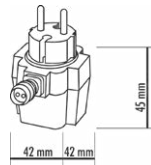

Versorgungsspannung: 230 V AC
Betriebsspannung: 12 V AC
Leistungsaufnahme: max. 10,5 W



Art.-Nr. 40166

Netzgerät 20 W
· Schutzart IP 44

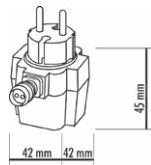

Versorgungsspannung: 230 V AC
Betriebsspannung: 12 V AC
Leistungsaufnahme: max. 21 W



Art.-Nr. 40167

Netzgerät 40 W
· Schutzart IP 44

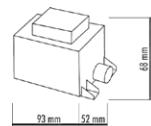

Versorgungsspannung: 230 V AC
Betriebsspannung: 12 V AC
Leistungsaufnahme: max. 45 W
Zuleitung: 2 m



Art.-Nr. 40163

Netzgerät 60 W
· Schutzart IP 44

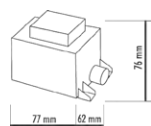

Versorgungsspannung: 230 V AC
Betriebsspannung: 12 V AC
Leistungsaufnahme: max. 60 W
Zuleitung: 2 m

1



Verlängerungskabel

- verwendbar unter anderem für:
- Serie Quellstar
 - Serie Aquaspot Halogen und Power LED

Art.-Nr. 40136	2,5 m
Art.-Nr. 40164	5 m
Art.-Nr. 40137	10 m

2



3fach Verteiler

- Schutzart IP 44
- Anschluss von bis zu 3 Geräten an ein Netzgerät

Art.-Nr. 40259

Verteiler

Gehäuse: Kunststoff

3



5fach Verteiler

- Schutzart IP 44
- Anschluss von bis zu 5 Geräten an ein Netzgerät

Art.-Nr. 40265

Verteiler

Gehäuse: Kunststoff

4



6er Quellsteinleuchte

- 6 LED
- Farbe: warmweiß
- Anschluss Gehäuse IP 68
- Anschluss Trafo IP 44
- ohne Trafo
- passendes Netzgerät 10 W



Art.-Nr. 10625

Quellsteinbeleuchtung

Anschluss (konisch):	19 mm
Betriebsspannung:	12 V AC
Leistungsaufnahme:	0,6 W
Durchfluss:	11 mm
Quellsteinbohrung:	32 mm
Zuleitung:	5 m
Gehäuse:	Kunststoff

5



Pumpe 600Led

inkl. Basismodul, Netzgerät und Leuchteinheit nach Wahl, Adapter - 1/2 Zoll, Regulierbare Leistung

Art.-Nr.: 40485

Versorgungsspannung:	12 V
Leistungsaufnahme:	10 W
Zuleitung:	10 m
Fördermenge:	600 Liter
Förderhöhe:	120 cm

6



Netzgerät 10 W

- Schutzart IP 44

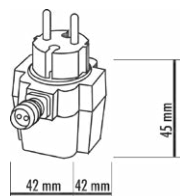

IP44/12V

Art.-Nr. 40255

Beleuchtungstechnik

Versorgungsspannung:	230 V AC
Betriebsspannung:	12 V AC
Leistungsaufnahme:	max. 10,5 W

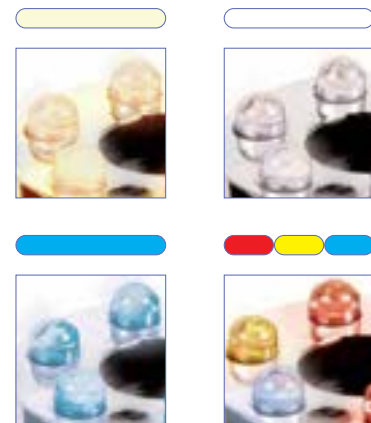

1 QUELLSTAR 600 12 Volt

Art.-Bezeichnung	Art.-Nr.	Abstrahlwinkel	Farbe	Kelvin	Lumen	EEK	Gesamtverbrauch	LED
Quellstar 600 warmweiß	40548	180°		2900-3300	9-12	A++	2,1 W	0,4 W
Quellstar 600 weiß	40545	180°		6500-7500	6-9	A++	2,1 W	0,4 W
Quellstar 600 blau	40280	180°		2400-2600	4,5-5,5	A++	2,1 W	0,4 W
Quellstar 600 RGB Farbwechsel	40547	180°		-	1,5 1,0 0,3	A++	2,1 W	0,4 W

Merkmale

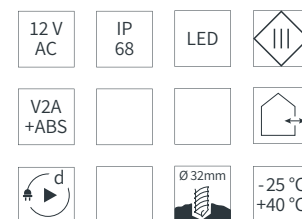

Lieferumfang

Leuchteinheit, Basismodul, 10 m Zuleitung, Steckernetzgerät 10 W

Zubehör optional



Art.-Nr.	Beschreibung
40281	Basismodul Quellstar 600 QS
40283	600 Leuchteinheit warmweiß
40285	QS 600 Leuchteinheit weiß
40284	QS 600 Leuchteinheit blau
40289	QS 600 Leuchteinheit RGB
40282	Dichtmanschette QS 600

Technische Zeichnungen

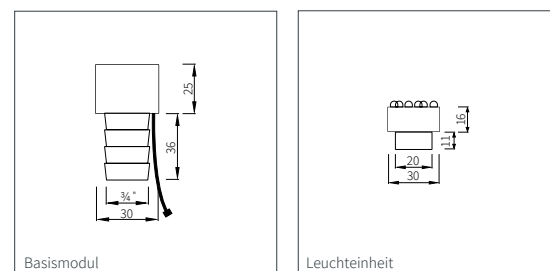

2 QUELLSTAR PRO 600 24 Volt

NEU! Lieferbar ab ca. FRÜHJAHR 2024

Art.-Bezeichnung	Art.-Nr.	Abstrahlwinkel	Farbe	Kelvin	Lumen	EEK	Gesamtverbrauch	LED
Quellstar Pro 600 warmweiß	310601	180°		2900-3100	10	A++	2,5 W	0,3 W
Quellstar Pro 600 weiß	310602	180°		6000	10	A++	2,5 W	0,3 W
Quellstar Pro 600 blau	310603	180°		2400-2600	8	A++	2,5 W	0,3 W
Quellstar Pro 600 RGB Farbwechsel	310604	180°		-	1,5 1,0 0,3	A++	2,5 W	0,3 W

Merkmale

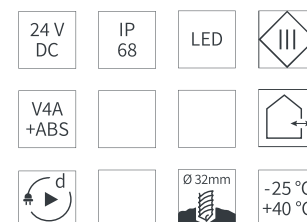

Lieferumfang

Leuchteinheit, Basismodul, 5 m Zuleitung, Steckernetzgerät 12 W

Zubehör optional



Art.-Nr.	Beschreibung
310600	Basismodul Quellstar Pro 600
310611	QS Pro 600 Leuchteinheit warmweiß
310612	QS Pro 600 Leuchteinheit weiß
310613	QS Pro 600 Leuchteinheit blau
310914	QS Pro 600 Leuchteinheit RGB
40282	Dichtmanschette QS Pro 600
40278	Zur Demontage des Leuchtkopfes
599000	¼" UV-Lichtbeständig, 20 m Rolle

Technische Zeichnungen

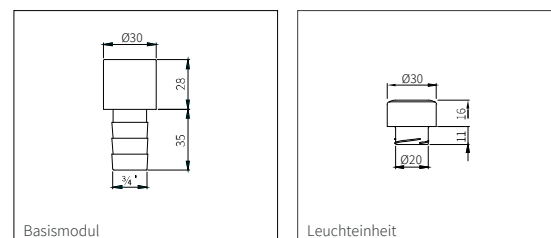

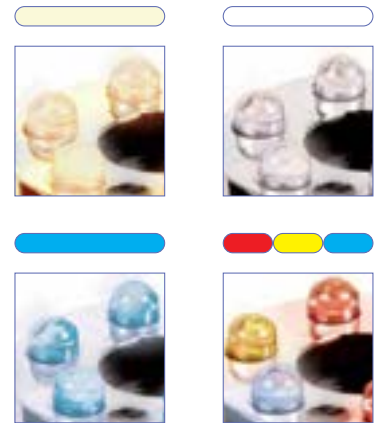

1 QUELLSTAR 900 12 Volt

Art.-Bezeichnung	Art.-Nr.	Abstrahlwinkel	Farbe	Kelvin	Lumen	EEK	Gesamtverbrauch	LED
Quellstar 900 warmweiß	40551	180°	□	2900-3300	18-22	A++	2,6 W	0,6 W
Quellstar 900 weiß	40552	180°	□	6500-7500	19-23	A++	2,6 W	0,6 W
Quellstar 900 blau	40290	180°	■	2400-2600	7-8	A++	2,6 W	0,6 W
Quellstar 900 RGB Farbwechsel	40553	180°	■	-	■ 2,0 ■ 1,5 ■ 0,4	A++	2,6 W	0,6 W

Merkmale

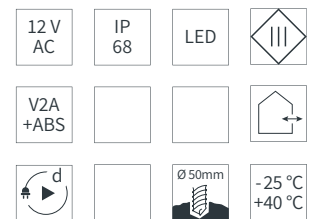

Lieferumfang

Leuchteinheit, Basismodul, 10 m Zuleitung, Steckernetzgerät 10 W

Zubehör optional

Art.-Nr.	Art.-Nr.
40291	Basismodul Quellstar 900
40293	QS 900 Leuchteinheit warmweiß
40295	QS 900 Leuchteinheit weiß
40294	QS 900 Leuchteinheit blau
40299	QS 900 Leuchteinheit RGB
40292	Dichtmanschette QS 900



Technische Zeichnungen

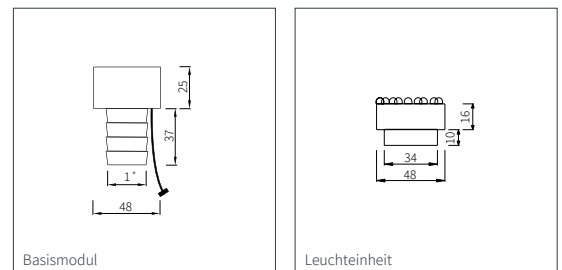

2 QUELLSTAR PRO 900 24 Volt

NEU! Lieferbar ab ca. FRÜHJAHR 2024

Art.-Bezeichnung	Art.-Nr.	Abstrahlwinkel	Farbe	Kelvin	Lumen	EEK	Gesamtverbrauch	LED
Quellstar Pro 900 warmweiß	310901	180°	□	2900-3100	15	A++	3,1 W	0,5 W
Quellstar Pro 900 weiß	310902	180°	□	6000	15	A++	3,1 W	0,5 W
Quellstar Pro 900 blau	310903	180°	■	2400-2600	12	A++	3,1 W	0,5 W
Quellstar Pro 900 RGB Farbwechsel	310904	180°	■	-	■ 2,0 ■ 1,5 ■ 0,4	A++	3,1 W	0,5 W

Merkmale

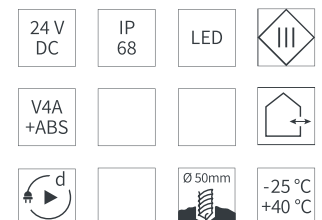

Lieferumfang

Leuchteinheit, Basismodul, 5 m Zuleitung, Steckernetzgerät 12 W

Zubehör optional

Art.-Nr.	Art.-Nr.
310900	Basismodul Quellstar Pro 900
310911	QS Pro 900 Leuchteinheit warmweiß
310912	QS Pro 900 Leuchteinheit weiß
310913	QS Pro 900 Leuchteinheit blau
310914	QS Pro 900 Leuchteinheit RGB
40292	Dichtmanschette QS Pro 900
40279	Zur Demontierung der Leuchteinheit
599001	Spiralschlauch 1" UV-Lichtbeständig, 20 m



Technische Zeichnungen

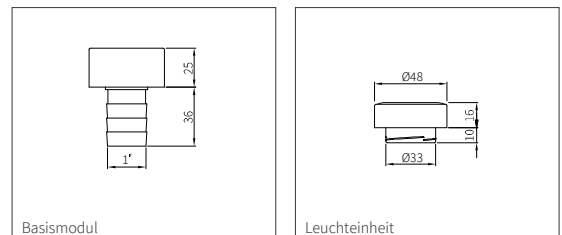

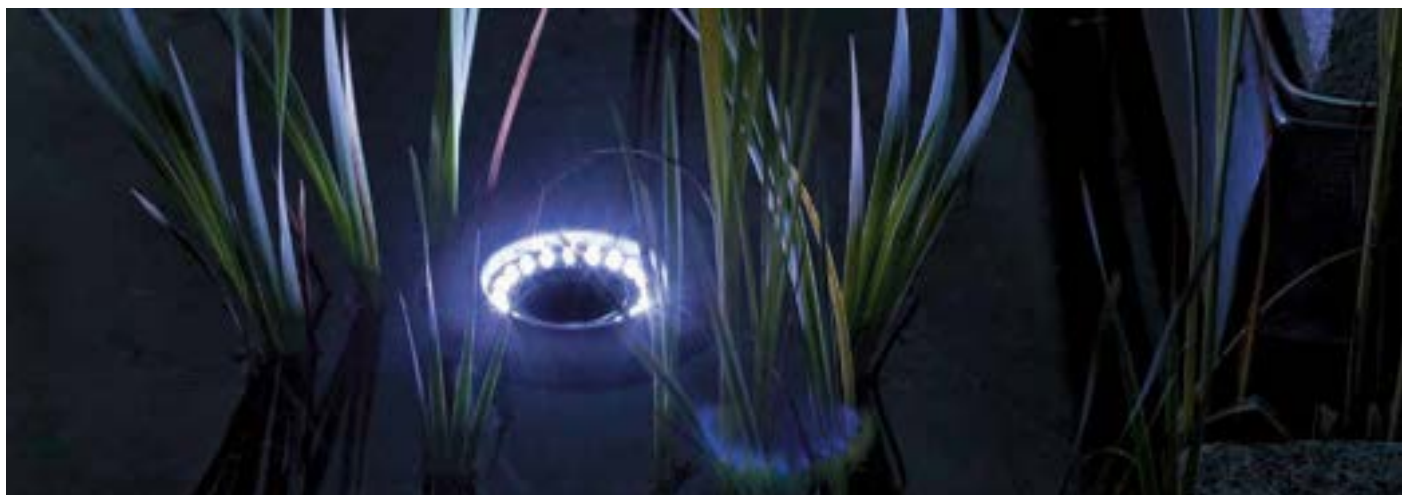

1 QUELLSTAR 2000 12 Volt

Art.-Bezeichnung	Art.-Nr.	Abstrahlwinkel	Farbe	Kelvin	Lumen	EEK	Gesamtverbrauch	LED
Quellstar 2000	40240	180°	■	2900-3300	50-60	A++	2,6 W	2 W

Merkmale

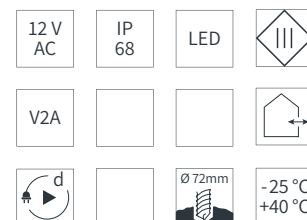

Lieferumfang
 Quellstar 2000 blau
 inkl. 10 m feste Zuleitung

Zubehör optional

Art.-Nr.
 41316

Schwimmring

Technische Zeichnungen

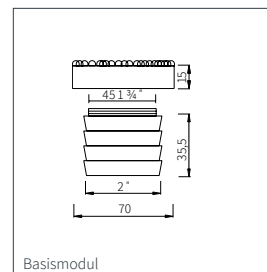

Basismodul

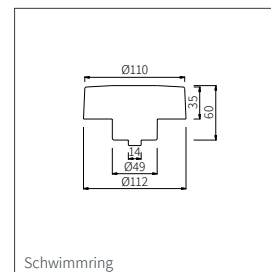

Schwimmring

2



Netzgerät 10 W

Art.-Nr. 40255

- 12 V/AC
- Schutzklasse IP 44

3 QUELLSTAR PRO 2000 24 Volt

NEU! Lieferbar ab ca. FRÜHJAHR 2024

Art.-Bezeichnung	Art.-Nr.	Abstrahlwinkel	Farbe	Kelvin	Lumen	EEK	Gesamtverbrauch	LED
Quellstar Pro 2000	312000	180°	□	2900-3100	40	A++	2,1 W	1,5 W

Merkmale

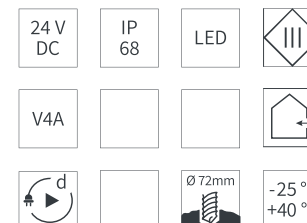

Lieferumfang
 Quellstar Pro 2000 inkl. 5 m feste Zuleitung

Zubehör optional

	Art.-Nr. 41316	Schwimmring
	312001	Schlauchtülle 1" Anschluss unten /zusätzl. Im oberen Bereich ein 2" Gewinde für Fontänenansätze
	599001	Spiralschlauch 1" UV-Lichtbeständig, 20 m Rolle



Technische Zeichnungen

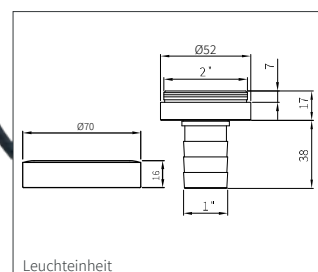

Leuchteinheit

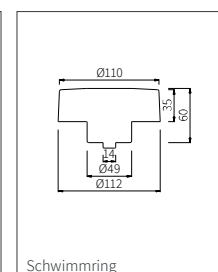

Schwimmring

1



Teich-Skimmer SK-30 Oberflächensauger Art.-Nr. SK 30

Produktdetails:

Netzspannung: 220-40 V/50 Hz
Durchflussmenge: max. 2.500 l/h
Leistung: 45 Watt
Teichoberfläche: ca. 25 m²
Gesamthöhe: ca. 23 cm
Ø Skimmerkopf: ca. 20 cm (ohne Schwimmkörper)
Kabellänge: ca. 10 m

2



Teich-Skimmer SK-40 Oberflächensauger Art.-Nr. SK 40

Produktdetails:

Netzspannung: 220-40 V/50 Hz
Durchflussmenge: max. 3.000 l/h
Leistung: 60 Watt
Teichoberfläche: ca. 40 m²
Gesamthöhe: ca. 24 cm
Ø Skimmerkopf: ca. 23 cm (ohne Schwimmkörper)
Kabellänge: ca. 10 m

3



Abbildung ähnlich

4



Abbildung ähnlich

Zimmerbrunnenpumpe 150

Art.-Nr. 40330

- Adapter 8 und 10 mm
- Netzgerät 10 W
- 150 l/h
- 38 cm Förderhöhe
- IP 68

Zimmerbrunnenpumpe 280

Art.-Nr. 40350

- Adapter 8, 10 und 13 mm
- Netzgerät 10 W
- 280 l/h
- 50 cm Förderhöhe
- IP 68

Zimmerbrunnenpumpe 280 L

Art.-Nr. 40365

- Adapter 8, 10 und 13 mm
- Netzgerät 12 W
- Halogenlampe 10 W
- 280 l/h
- 50 cm Förderhöhe
- IP 68

Zimmerbrunnenpumpe 320 L

Art.-Nr. 40380

- Adapter 8, 10 und 13 mm
- Netzgerät 10 W
- Halogenlampe 10 W
- 320 l/h
- 55 cm Förderhöhe
- IP 68

5



Brunnen- & Nebler-Spezial

Biologisch abbaubar
Für sauberes und
hygienisches Wasser
im Innen- und Außenbereich
Art.-Nr. 59050
Inhalt 0,5 l Konzentrat





ECO
Asynchron

ECO Pumpen „Die intelligente Wahl für den umweltbewussten Verbraucher“.

ECO Pumpen sind für jede Filteraufgabe geeignet und fördern mühelos Schmutzpartikel bis zu 8 mm.

ECO Pumpen sind auch ideal für den Betrieb von Wasserfällen und Wasserläufen. ECO Pumpen haben einen großen internen Saug für Skimmer und Teichrandfilter.

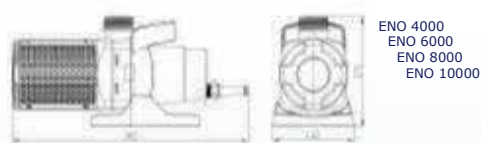
Best. Nr.	Model	L/h.	Watt	H. max.	VE	Volt/Hz	EAN/Barcode
AT 001036	ECO 3600	3.600	45	2,0 m	2	230V / 50Hz	5704979001048
AT 001048	ECO 4800	4.800	54	2,1 m	2	230V / 50Hz	5704979001055
AT 001072	ECO 7200	7.150	72	2,5 m	2	230V / 50Hz	5704979001079
AT 001110	ECO 11000	10.850	135	3,4 m	2	230V / 50Hz	5704979001116
AT 001140	ECO 14000	14.200	175	4,1 m	2	230V / 50Hz	5704979001147
AT 001180	ECO 18000	17.900	210	5,5 m	2	230V / 50Hz	5704979001185
AT 001220	ECO 22000	22.000	330	5,7 m	2	230V / 50Hz	5704979001222
AT 001250	ECO 25000	24.300	375	6,3 m	2	230V / 50Hz	5704979001253

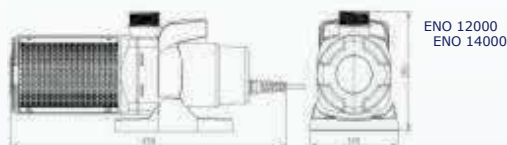

ENO 4000
ENO 6000
ENO 8000
ENO 10000

Edelstahl

ENO 12000
ENO 14000

ENO

Eine extra kräftige Pumpe, die speziell für den Betrieb von Filteranlagen, Bachläufen, Düsen, Wasserwänden, Figuren und Rolling Balls geeignet ist.

ENO Pumpen können auch trocken montiert werden, da sie ein großes, äußeres Gewinde an sowohl Einlauf- als Auslaufseite haben.

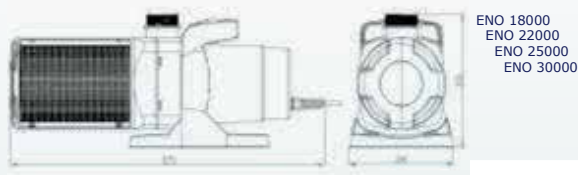

ENO 18000
ENO 22000
ENO 25000
ENO 30000

Asynchron

Best. Nr.	Model	L/h.	Watt	H. max	Auslauf	Einlauf	VE	Volt/Hz	EAN/Barcode
AS 020400	ENO 4000	3.800	55	2,0 m	1½"	1½"	4	230V / 50Hz	5704979000300
AS 020600	ENO 6000	5.600	65	2,2 m	1½"	1½"	4	230V / 50Hz	5704979000331
AS 020800	ENO 8000	7.500	110	3,2 m	1½"	1½"	4	230V / 50Hz	5704979000362
AS 021000	ENO 10000	9.500	140	4,0 m	1½"	1½"	4	230V / 50Hz	5704979000393
AS 021200	ENO 12000	12.000	165	4,5 m	1½"	2"	2	230V / 50Hz	5704979000423
AS 021400	ENO 14000	14.000	245	5,2 m	1½"	2"	2	230V / 50Hz	5704979000454
AS 021800	ENO 18000	18.000	350	6,0 m	2"	2"	2	230V / 50Hz	5704979000485
AS 022200	ENO 22000	22.000	420	7,0 m	2"	2"	2	230V / 50Hz	5704979000515
AS 022600	ENO 26000	26.000	500	7,5 m	2"	2"	2	230V / 50Hz	5704979000546
AS 023000	ENO 30000	30.000	650	8,0 m	2"	2"	2	230V / 50Hz	5704979000577

AC ECO

Neue Steuerbox 100% wasserdicht und mit mehr Stufen
Neuer Vorfilter - größer und stärker
Neue stärkere GummifüÙe



AC ECO sind mit besonders leistungsstarken 6-Spulen Motoren ausgestattet, die für eine hohe Kapazität zu einem geringen Energieverbrauch sorgen.

Alle AC ECO Modelle sind mit einer externen Steuerbox/Drehzahlregler ausgestattet, welches es ermöglicht, den Durchfluss zu drosseln und dadurch auch den Stromverbrauch zu reduzieren.

Durch einfaches Drücken der FEED-Taste stoppt die Pumpe für 5 Minuten, sodass Ihre Fische das Futter auffressen können und es nicht in die Pumpe oder einen eventuellen Skimmer gesaugt wird, um schließlich im Filter zu landen! Nach 5 Minuten startet die Pumpe dann wieder in der gewählten Einstellung und sichert so eine optimale Gesundheit Ihrer Fische.

Die Pumpen fördern problemlos Schmutzpartikel bis zu 8 mm Korngröße durch das Rotorsystem. Der Wasserdurchfluss und die Fördermenge werden davon nicht beeinflusst. Die Pumpen können im Gartenteich überwintern. Sie müssen dazu jedoch mindestens 80 cm tief unter dem Wasserniveau platziert sein und mindestens einmal im Monat für 5 Minuten betrieben werden.

Die Pumpen können trocken montiert werden. Jedoch muss der Einlauf immer 20 cm unter dem Wasserspiegel sein. Montieren Sie zum Schutz der Pumpe einen Vorfilter. Auf die Pumpen erhalten Sie 2 Jahre Garantie, diese kann um 5 Jahre auf insgesamt 7 Jahre erweitert werden, sofern die Garantievorschriften eingehalten werden.

Flow und Power auf dem neuen AC ECO – mit mehr Schritten und weniger Energieverbrauch.

AC ECO 6000	
Flow in L/H	Power in watt
1100	14
1800	20
2500	26
3200	32
3900	38
4600	44
5300	50
6000	56

AC ECO 20000	
Flow in L/H	Power in watt
4300	30
6000	44
7800	58
9500	73
11300	88
13000	102
14800	117
16500	132
18300	146
20000	158

AC ECO 30000	
Flow in L/H	Power in watt
5000	55
8000	80
10000	105
13000	130
15000	155
18000	180
21000	205
24000	230
27000	255
30000	280

AC ECO 12000	
Flow in L/H	Power in watt
1600	18
3050	29
4500	40
6000	51
7500	62
9000	72
10500	82
12000	92

AC ECO 40000	
Flow in L/H	Power in watt
9000	70
12000	100
15000	130
18500	165
22000	195
26000	230
29500	260
33000	295
36500	325
40000	360



FIL-Reset

FIL-Reset
Druckfilter werden mit kräftigem Einbau UVC geliefert.

FIL-Reset
hat einen eingebauten Schlamm- und Durchfluss Indikator und ein extra Absperrventil.

FIL Reset
ist einfach zu warten, leicht von außen zu reinigen und der Schlamm des Filters kann z.B. in ein Blumenbeet geleitet werden.

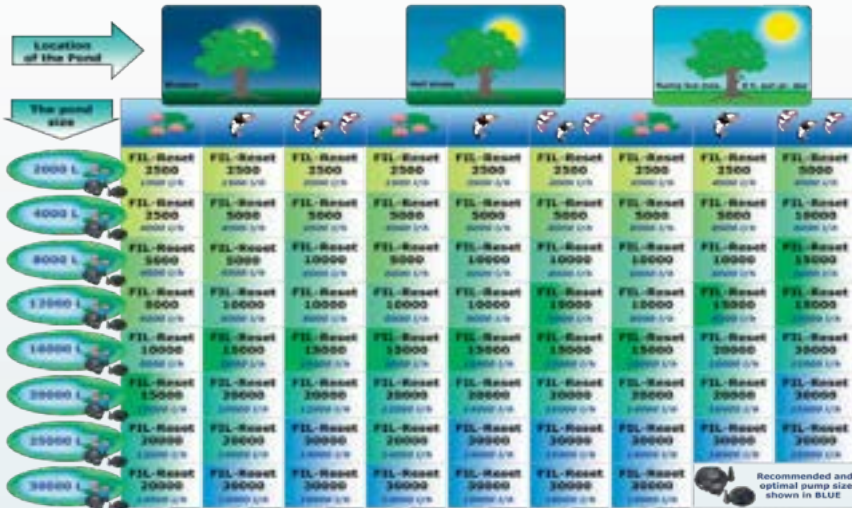

Mit Bepflanzung und ohne Fische oder wenigen Fischen d.h. 1 cm Fisch per 25 L. Teichwasser



Mit kleinem Fischbestand d.h. 1 cm Fisch per 10 L. Teichwasser



Mit normalem Fischbestand d.h. 1 cm Fisch per 5 L. Teichwasser

Best. Nr.	Model	L/h.	Ein-/Auslauf	UVC	VE	Inhalt	EAN/Barcode
DM 000500	FIL-Reset 5000	3600 - 7200	3/4 - 1,5"	11 W	2	25 L	5704979100185
DM 001000	FIL-Reset 10000	4000 - 8000	3/4 - 1,5"	18 W	2	30 L	5704979100208
DM 001500	FIL-Reset 15000	7200 - 11000	3/4 - 1,5"	24 W	2	45 L	5704979100222
DM 002000	FIL-Reset 20000	8000 - 16000	1 1/4-2"	36 W	1	50 L	5704979100246
DM 003000	FIL-Reset 30000	10000 - 18000	1 1/4-2"	55 W	1	75 L	5704979100260



UVC Light



Best. Nr.	Model	Länge	UV Output	Fassung	Haltbarkeit	EAN/Barcode
FN 220105	UVC-PL 5 Watt	85 mm	12 µW/cm2	G23	8.000 Stunden	5704979210006
FN 220107	UVC-PL 7 Watt	115 mm	20 µW/cm2	G23	8.000 Stunden	5704979210037
FN 220109	UVC-PL 9 Watt	145 mm	23 µW/cm2	G23	8.000 Stunden	5704979210068
FN 220111	UVC-PL 11 Watt	214 mm	33 µW/cm2	G23	8.000 Stunden	5704979210099
FN 220113	UVC-PL 13 Watt	164 mm	31 µW/cm2	G23	8.000 Stunden	5704979210129
FN 220118	UVC-PL 18 Watt	217 mm	60 µW/cm2	2G11	8.000 Stunden	5704979210150
FN 220124	UVC-PL 24 Watt	317 mm	90 µW/cm2	2G11	8.000 Stunden	5704979210181
FN 220136	UVC-PL 36 Watt	410 mm	120 µW/cm2	2G11	8.000 Stunden	5704979210211
FN 220155	UVC-PL 55 Watt	530 mm	170 µW/cm2	2G11	8.000 Stunden	5704979210242



A

Pos.	Best. Nr.	Schlauchtülle PP	Größe
A	PO 003000	1/4" Außengewinde	6 mm Stutzen
A	PO 003010	1/4" Außengewinde	8 mm Stutzen
A	PO 003020	1/4" Außengewinde	9 mm Stutzen
A	PO 003030	1/2" Außengewinde	9 mm Stutzen
A	PO 003040	1/2" Außengewinde	13 mm Stutzen
A	PO 003050	1/2" Außengewinde	19 mm Stutzen
A	PO 003060	3/4" Außengewinde	13 mm Stutzen
A	PO 003070	3/4" Außengewinde	19 mm Stutzen
A	PO 003080	3/4" Außengewinde	25 mm Stutzen
A	PO 003090	1" Außengewinde	13 mm Stutzen
A	PO 003100	1" Außengewinde	19 mm Stutzen
A	PO 003110	1" Außengewinde	25 mm Stutzen
A	PO 003120	1" Außengewinde	32 mm Stutzen
A	PO 003130	1 1/4" Außengewinde	25 mm Stutzen
A	PO 003140	1 1/4" Außengewinde	32 mm Stutzen
A	PO 003141	1 1/4" Außengewinde	40 mm Stutzen
A	PO 003142	1 1/2" Außengewinde	40 mm Stutzen
A	PO 003144	1 1/2" Außengewinde	50 mm Stutzen
A	PO 003146	2" Außengewinde	50 mm Stutzen



D

Pos.	Best. Nr.	Behälterdurchführung PP, schwarz
D	PK 037075	3/4" Außengewinde
D	PK 037100	1" Außengewinde
D	PK 037125	1-1/4" Außengewinde
D	PK 037150	1-1/2" Außengewinde
D	PK 037175	2" Außengewinde
D	PK 037200	3/4" Innengewinde x 1-1/4" Außengewinde
D	PK 037225	1" Innengewinde x 1-1/4" Außengewinde



F

Pos.	Best. Nr.	Winkelstück	Größe
F	PP 001600	90°	6 x 6 mm
F	PP 001620	90°	10 x 10 mm
F	PP 001630	90°	13 x 13 mm
F	PP 001640	90°	16 x 16 mm
F	PP 001650	90°	19 x 19 mm
F	PP 001660	90°	25 x 25 mm
F	PP 001680	90°	32 x 32 mm
F	PK 031150	90°	38 x 38 mm



B

Pos.	Best. Nr.	Verteiler	Größe
B	PO 003800	3-Wege gerade 3/4" Außengewinde x 3 x 9 mm Stutzen	



C

Pos.	Best. Nr.	Schlauchtülle universal	Größe
C	PO 004100	3/4" Außengewinde	25-20-13 mm Stutzen
C	PO 004120	1" Außengewinde	25-20-13 mm Stutzen
C	PO 004200	1 1/4" Außengewinde	40-32-25 mm Stutzen



E

Pos	Best. Nr.	Schlauchtülle	Größe
E	PP 001180	Außengewinde	1/2" x 10 mm
E	PP 001190	Außengewinde	1/2" x 13 mm
E	PP 001200	Außengewinde	1/2" x 16 mm
E	PP 001210	Außengewinde	1/2" x 19 mm
E	PP 001220	Außengewinde	3/4" x 10 mm
E	PP 001230	Außengewinde	3/4" x 13 mm
E	PP 001240	Außengewinde	3/4" x 19 mm
E	PP 001250	Außengewinde	3/4" x 25 mm
E	PP 001260	Außengewinde	1" x 13 mm
E	PP 001270	Außengewinde	1" x 19 mm
E	PP 001280	Außengewinde	1" x 25 mm
E	PP 001290	Außengewinde	1" x 32 mm



G

Pos.	Best. Nr.	Schlauchverbinder	Größe
G	PP 001800	Gerade	6 x 6 mm
G	PP 001820	Gerade	10 x 10 mm
G	PP 001830	Gerade	13 x 13 mm
G	PP 001840	Gerade	16 x 16 mm
G	PP 001850	Gerade	19 x 19 mm
G	PP 001860	Gerade	25 x 25 mm
G	PP 001880	Gerade	32 x 32 mm



Waldschatr Vogel
farbige Mütze
Art.-Nr.: GR/1010
Maße: L18 x B 20 x H
36cm, ca. 8 Kg



Waldschatr Pilz farbige Mütze
Maße: L 16 x B 19 x H 36cm, ca. 8 Kg
Art.-Nr.: GR/1011



Waldschatr Groß farbige Mütze
Maße: L 25 x B 28 x H 49cm, ca. 22Kg
Art.-Nr.: GR/1013



Waldkind Eichhörn farbige Mütze
Maße: L 27 x B 23 x H 39cm, ca. 13Kg
Art.-Nr.: GR/255



Waldkind Igel farbige Mütze
Maße: L 24 x B 25 x H 38cm, ca. 12Kg
Art.-Nr.: GR/256



Vogeltränke
"relax Frosch"
Maße: L 25 x B 25 x H 8cm, ca. 1,5 Kg
Art.-Nr.: G/531



RELAX Frosch liegend/hängend
Maße: L 12 x B 22 x H 30cm, ca. 3,5 Kg
Art.-Nr.: G/530



Eichhörnchen klein
Maße: L 11 x B 18 x H 18cm, ca. 2,5Kg
Art.-Nr.: 1130



Löwen-KÖNIG Goldkrone
Maße: L 18 x B 13 x H 36cm, ca. 6 kg
Art.-Nr.: BI/619



LÖWE rechts
Maße: L 14 x B 8,5 x H 20cm, ca. 2 kg
Art.-Nr.: G/612



LÖWE links
Maße: L 14 x B 8,5 x H 20cm, ca. 2 kg
Art.-Nr.: G/613



Wildschwein
Maße: L 23 x B 55 x H 32cm, ca. 25 kg
Art.-Nr.: G/941



Labrador
Maße: L 28 x B 18 x H 38cm, ca. 15 kg
Art.-Nr.: G/397



Eule/Kautz
Maße: L 16 x B 19 x H 42cm, ca. 11 kg
Art.-Nr.: G/70



Dackel groß auf Platte
Maße: L 21 x B 48 x H 34cm, ca. 15 kg
Art.-Nr.: G/396



Buddha klein
Maße: L 8 x B 14 x H 21cm, ca. 1 kg
Art.-Nr.: G/232



Dickbauchbuddha
Maße: L xx X B xx X H xxcm, ca. 5 kg
Art.-Nr.: G/160



Buddha stehend, "art anthrazit" Art.-Nr.: A/226
 Buddha stehend, "GrauGRün" Art.-Nr.: G/226
 Buddha stehend, "art rost" Art.-Nr.: R/226
 Maße: L 11 x B 11 x H 67cm, ca. 8 kg



Buddha knieend
 Maße: L 15 x B 14 x H 43cm, ca. 9 kg
 Art.-Nr.: G/176



Buddha Wandbild zum Hängen
 Maße: B 20 x H 29cm, ca. 1 kg
 Art.-Nr.: G/172



Wandkranz "Papagei"
 Maße: L 40 x B 40 x H 6cm, ca. 8 kg
 Art.Nr.: G/986



G/048
VT. 3 Vögel am Blatt
25x42x19h, 8kg

V1
4260414597244



G/045
VT. Schale/Herz (feste Vögel)
28x27x19h, 8kg

V1
4260414596360



G/035
VT. Blatt, & 2 Vögel (fest)
30x26x09h, 6kg

V1
4260414596230



G/030
VT. Blatt mit 4 Vögel (fest)
31x18x11h, 4kg

V1
4260414595240



G/047
Insektentränke & losem Schmetterling
17x25x14h, 7kg

V1

4260414596377



G/044,
VT. Schale/Nest (fester Vogel)
37x37x22h. 9kg

V1

426041596353



G/021 Muschelvogeltränke & 2Vögel (lose) 50x50x20h, 32kg 4260414590016	V3	G/021+Sockel Muschelvogeltränke mit loseem Sockel 50x50x53h, 32kg 4260414590030	V3	G/021Sockel, 30x30x33h,29kg 4260414590023	V3
--	----	---	----	--	----



G/024 V2
VT. Zwei Hände & 2Vögel (lose)
30x30x20h, 9kg 4260414590085



G/026 V2
VT. Muschel klein & Vogel (lose)
33x33x12h, 9kg 4260414590108



G/040 V1
VT. Kleeblatt & fester Vogel
30x30x00h, 5kg 4260414595257



G/529 V1
VT. „Die 3 Frösche“
29x26x34h, 7kg 4260414597237



G/950 Huhn brütend "klein" V1
15x11x15h,2kg 4260414597084



G/952 Huhn brütend "mittel" V1
25x16x20h, 5kg 4260414597107

G/954 Huhn auf Sonnenblume V2
34x19x35h, 11kg 4260414597121



G/951 Huhn stehend klein V1
21x13x26h, 3kg 4260414597091



G/953 Huhn stehend mittel V2
24x16x34h, 10kg 4260414597114



G/955 Hahn „Der Chef“ V2
31x17x41h, 10kg 4260414597138



G/958 Huhn „pickend“ groß V3
40x24x45h, 20kg 4260414597145



G/356
Adler, schaut zurück, 70
28x45x70h, 44kg

V3

4260414597350



G/357
Adler, schaut zurück 107,
37x50x107h, 95kg

V4

4260414591990



G/355 Adler „schaut zurück“ 50 V2
35x18x50h, kg 4260414591969



G/349 Stolzer Adler V3
19x18x54h16kg 4260414595486



G/350 Adler V3
28x34x49h, 24kg 4260414591952



G/358 Adler, Flügel offen XXL, 114Flügelspann x77x110höhe, 130kg, 4260414592003

V4



G/348
Adler, „gespannte Flügel“
35x55x60h, 25kg

V3

4260414591969



G/351
Adler, „Flügel offen X“
60x40x80h, 35kg

V3













4260414596179



G/71 Eule, 40cm 22x20x40h, 12kg	V2	G/71-2 Eule, 29cm 15x14x29h, 8Kg	V1	G/79 Eule „Weißkopf“ 18x12x25h, 4kg	V1
4260414590597		4260414590603		4260414595523	



G/490 Ente „starkes Gefieder“ 20x14x31h, 5kg	V1	G/493 Gans „mit Kind“ 24x19x36h, 10kg	V1	G/492 Doppelente 27x26x32h, 11kg	V1
4260414592478		4260414595974		4260414594397	

							
G/37-1 klein 13x10x8h, 1kg	V1 4260414590313	G/37-2 klein 13x10x8h, 1kg	V1 4260414590351	G/37-3 14x12x10h, 1kg	V1 4260414590368		
G/37-4 groß 17x21x11h, 1kg	V1 4260414590375	G/37-5 groß 17x21x11h, 1kg	V1 4260414590337				
							
G/37-6 duo klein 17x21x11h, 1kg	V1 4260414590320	G/37-7 duo groß 19x19x10h, 2kg	V1 4260414590344				
							
G/87 24x14x18h, 3,5kg	V1 4260414590726	G/85 20x13x16h, 3,5kg	V1 4260414590702	G/86 23x14x18h, 3,5kg	V1 4260414590719		
							
G/84 26x20x23h, 9kg 4260414590696	V1	G/83 19x13x15h, 3kg 4260414590689	V1	G/024h 18x10x12, 1kg 4260414590054	V1	G/024U 18x10x14h 1kg 4260414590061	V1



G/1131
Eichhörnchen am Stamm, 18x36x32h. 10kg 4260414597220

V2



G/89
Willkommen Vögel, 3er, 15x48x26h, 15kg, 4260414596599

V2



G/88
Willkommen Vögel, 2+1, 16x58x25h, 17kg, 4260414596582

V2



G/90 Vögel mit Nest, 15x40x27h, 10kg, 4260414596605

V2



G/412 „Windhund liegend“
83x22x39h, 32kg

V4
4260414596704



G/427 Windhund stehend V3
21x21x80h,30kg/ 4260414594656



G/410 französische Bulldogge V3
45x23x40h,26kg 4260414596896



G/411 „kleine französische Bulldogge“ V1
25x20x32h, 8kg 4260414592263



G/418 „Pointer“ V3
60x30x74h, 60kg 4260414592324



G/422 „Labrador liegend“
50x30x33h, 28kg

V3
4260414592362

G/429 „Bullterrier“
35x42x51h, 30kg

V3
4260414596261



G/428 KÖNIGSHUND, Mops
22x30x25h, 12kg
4260414595400

V2

G/413 „Schäferhund m. Halsband“
20x30x43h, 15kg
4260414592270

V2

G/420 „Basset“
50x22x47h, 30kg
4260414592348

V3



G/399 „Hund mit Noppenball“
16x38x25h, 10kg

V2
4260414597183

G/424 Rauhaardackel
35x22x24h, 10kg

V2
4260414592379

G/408 „Dackel“
34x15x25h, 8kg

V2
42604145952249



G/317 „Katze klein gerollt grobes Fell“ 22x27x11h, 5kg	V1 4260414594786	G/318 „Katze gehockt grobes Fell“ 35x19x17h, 8kg	V1 4260414594793	G/320 „Katze eingerollt grobes Fell“ 28x28x12h, 9 kg	V1 4260414595462
--	---------------------	--	---------------------	--	---------------------



G/321 Katze runder Rücken, grobes Fell 30x20x19h, 8kg	V1 4260414595592	G/322 Katze, aufrecht sitzend 22x16x32h, 7kg	V1 4260414596384
--	---------------------	---	---------------------



G/301 Katze lang liegend 40x22x15h, 9kg	V1 4260414591761	G/302 Katze gerollt liegend 34x27x17h, 11kg	V2 4260414591778
--	---------------------	--	---------------------



G/376 Schildkröte XXL V3 66x52x35h, 90 kg	4260414596070	GR/376 Schildkröte XXL V3 66x52x35h, 90 kg	4260414596346
--	---------------	---	---------------



G/377 SchildkröteXL,44x39x26h29kg	4260414596728 V3	GR/377SchildkröteXL 44x39x26h29kg	4260414597015 V3
-----------------------------------	------------------	-----------------------------------	------------------

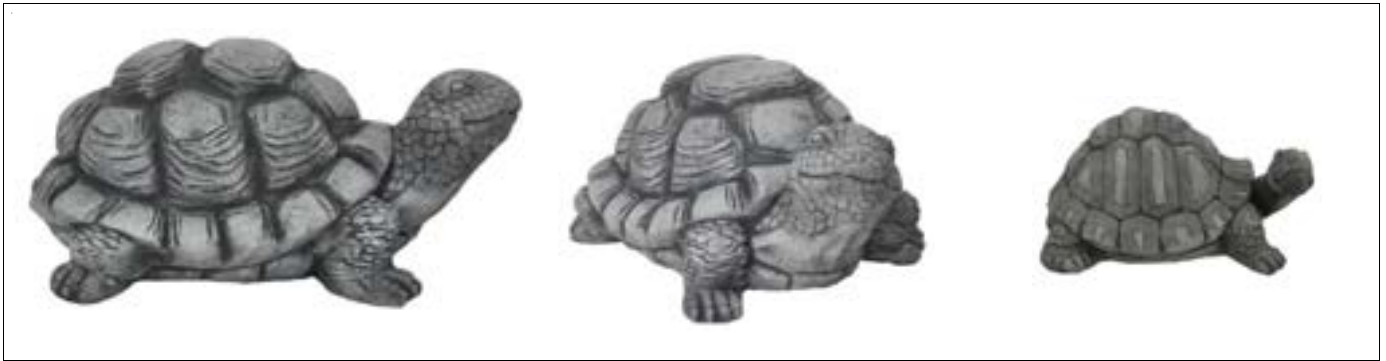

G/374, Schildkröte XL 43x29x18h, 22kg, 4260414592089	V3	G/373, Schildkröte X 29x22x15h,7kg 4260414592072	V1	G/370, Schildkröte S 26x17x14h,,6kg 4260414592058	V1
				G/371, Schildkröte XS, 14x10x7h, 0,5kg 4260414592065	V1

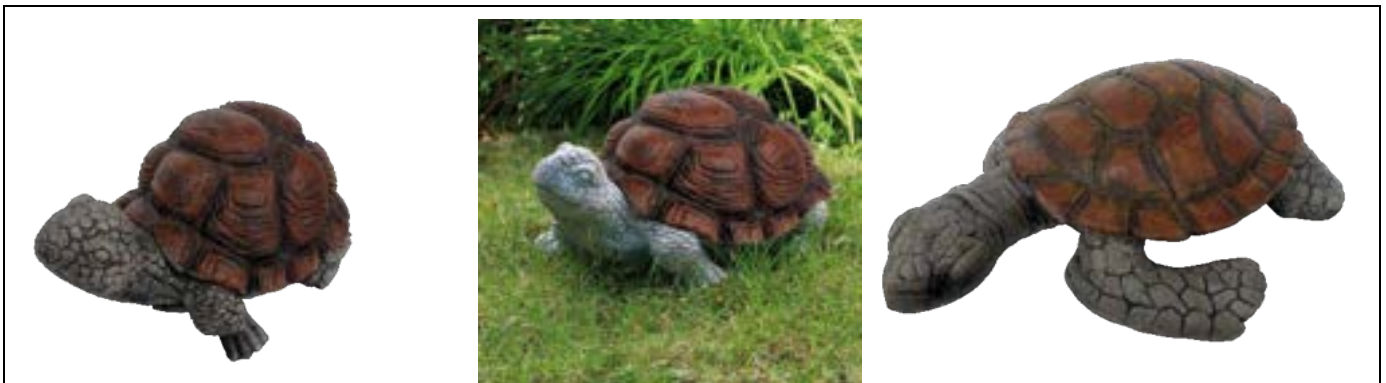

GR/1373 Schildkröte „Kunibert“ 29x22x15hh, 7kg, 4260414596568	V1	GR/1374 Schildkröte“Shely“ 43x29x18h,22kg	V3	4260414596575	GR/379 Wasserschildkröte „Rost Panzer“ 47x41x13h, 20kg	V3	426014596667
---	----	---	----	---------------	--	----	--------------



G/331, Igel liegend XL
40x25x23h, 25kg,

V3
4260414591877

G/332, Igel, stehend XXL
30x30x40h, 34kg

V3
4260414591884



G/360
Taubenpaar, länglich
38x14x21h, 7kg 4260414592027

V2



G/333
Igel stehend M
15x16x21h, 5kg 4260414591891

V1

G/334
Igel, stehend S
11x11x14h, 2kg 426014591907

V1



G/385
Schnecke X
30x18x15h, 6kg,
4260414592119

V1

G/386
Schnecke XL
42x26x21h, 19kg
4260414592126

V2

G/381
Schnecke langer. Hals
38x18x15h, 6,5kg
4260414592102

V1

G/380
Schnecke Kopf hoch
30x17x17h. 8,5kg
4260414592069

V1



G/1665 Wolf gestreckt,
100x27x69h,150kg,

V4
4260414596131



G/1660 Wolf heulend,
100x27x99h,150kg,

V4
4260414596124



G/1667 Wolf mittelgroß
60x30x64h, 45kg

V4
4260414597312



G/624 ESEL stehend 50x26x50h., 25kg

4260414597305

V3



G/620, ESEL, GROß 54x45x43h25kg 4260414593154 V3



G/621, Esel, klein 20x32x27h8Kg 4260414593161 V2



G/433 Pferd liegend, 38x28x28h12kg 4260414592423 V3



G/436 Pferdekopf 36x14x34h11kg 4260414594762 V2



G/642 Elefant kurze Zähne V1
14x27x31h, 6kg 4260414594281



G/647 Lustiger Elefant V1
25x23x30h, 9kg 4260414597169



G/665 Elefant „laufend“ V3
42x25x34h, 19kg 4260414596065



G/664 V1
Elefant, "MIKE" 27x25x29h, 15kg
4260414595752



G/646 V1
Elefant, Indisch klein, 30x16x20h, 10kg,
4260414596766



G/643 V3
Elefant & Mönchs Kind
26x55x44h, 45kg
426041459509

					
G/611	V1	G/610	V1	G/619	V1
Löwe, schaut nach links		Löwe, schaut nach rechts		Löwen-König	
25x14x35h, 9kg		25x14x35h, 9kg		18x13x36h, 6kg	
4260414595967		4260414595950		4260414597282	

					
G/616	V3	G/618	V3	G/617	V3
Löwe groß, gerade		Löwe groß n. links		Löwe groß, n. rechts	
31x22x52h, 33kg		35x22x53h, 37kg		35x22x53h, 37kg	
4260414595622		4260414595943		4260414595936	



G/613L Löwe, laufend groß 110x50x78h, 190kg 4260414597381

V4



G/470
Nashorn 45x18x26h, 15kg

V3

4260414597053



G/475
Nilpferd 24x30x35h, 20kg

V3

4260414597060



G/440
Der schlaue Fuchs 21x25x39h, 12kg

V2

4260414597190



G/699
Hase/Kaninchen groß 18x39x38h, 13kg

V3

4260414597213



G/512	V3	BI/512	V3	BI/509	V2	G/509	V2	G/513	V3	BI/513	V3
Froschkönig auf der Kugel		Froschk.a.Kugel (GoldKrone/kugel)		Froschkönig GoldKrone&Kugel		Froschkönig Krone&Kugel		Froschkönig XL (grau/grün)		Froschkönig XL (Goldkugel/krone)	
24x24x41h, 24kg		24x24x41h, 24kg		25x25x34h, 11kg		Grau/grün		36x36x46h, 27kg		36x36x46h, 27kg	
4260414594298		4260414594304		4260414592591		4260414592584		4260414594311		4260414594328	



G/515	V1	G/518	V3
Willkommen „FROSCHTRIO“		Willkommen „FROSCHDUO“	
11x35x17h, 3kg	4260414594724	42x19x32h, 22kg	4260414595394



G/529	V2	G/506	V2	G/510	V2
„Die 3 Frösche“		Frosch Kantenhocker		Frosch „am Stiefel“ „zur Bepflanzung“	
29x26x34h, 7kg		25x26x31h, 7kg		29x26x34h, 7kg	
4260414597237		4260414592553		4260414597275	



G/516
JogaFrosch, klein
35x20x28höhe, 8kg
4260414594700

V1

G/520
JogaFrosch, Mittel
23x40x36höhe, 14kg
4260414595806

V2



G/517
JogaFrosch, Groß
53x30x50höhe, 30k

V3

4260414594717



G/521
Froschtrio, Hören, Sehen, Sagen
17x24x46h, 12kg
4260414596513

V2



BI/524, Froschkönig
Hand am Kopf
32x26x52höhe, 33 kg
4260414597374

V3

BI/525, Froschkönig
Hände a Knieen
32x26x52höhe, 33 kg
4260414597374

V3

G/363 V3
Skalar,
Wasserspeier
53x22x60h, 31kg
4260414596711



G/368 Koi Klein V1
26x9x10h, 1kg
4260414592034

G/367 Koi Mittel V1
32x15x11,5 h, 4kg
4260414595875

G/366
Fisch, Koi, groß,
64x24x25h, 16kg

V3

4260414595882



G/365
Fisch, lang liegend, 38x38x17h, 9kg

V2
4260414596216

G/364
Fisch, WP, Wasserspeier, 34x17x22h, 6kg, 4260414596209

V1



KLEIN **V3**

G/1550
23x36x53h, 26kg
4260414595813

R/1550
23x36x53h, 26kg
4260414595912 art-rost

A/1550
23x36x53h, 26kg
4260414597404 art-anthrazit

GROß **V4**

G/1553
40x60x87h, 120kg
4260414595820

R/1553
40x60x87h, 120kg
4260414595929 art-rost

A/1553
40x60x87h, 120kg
4260414597411 art-anthrazit



G

R

A



GR/1007 Zwerg Groß, farbige Mütze	V2
20x25x61h, 17 kg	4260414596957
G/1007 Zwerg Gr. Einfarbig	V2
20x25x61h, 17 kg	4260414596889
GR/1005 Zwerg FARBIGE Mütze rechts	V1
14x16x32h, 5 kg	4260414596414
G/1005 Zwerg einfarbig	4260414596391
GR/1006 Zwerg FARBIGE Mütze links	V1
14x16x32h, 5 kg	4260414596421
G/1006 Zwerg links, einfarbig	4260414596407



G/1013 V3
 Waldschrat-Zwerg-Groß 25x28x49h, 22kg
 4260414594236



G/1009, Zwerge, „WILKOMMEN“

43x13x29h, 12kg

4260414594540

V2



G/1030	V1	G/1031	V1	G/1032	V1	G/1033	V1
Zwerg mit Vogel, sitzend		Zwerg, mit Schildkröte sitz.		Zwerg, mit Pfeife, stehend		Zwerg, mit Schnecke, stehend	
34x20x34h, 8 kg		33-18-38h. 9Kg		18x19x45h,9kg		15x15x40h, 5kg	
4260414595677		4260414595684		4260414595691		4260414595707	



G/1000	V3	G/1002	V2	G/1001	V3
Zwerg „LAMPI“		Zwerg, „Fauler Sack“ Sack zur		Zwerg „BUBI“	
28x24x56h, 24kg (incl Lampe)		Bepflanzung. 27x33x26h, 14kg		30x20x56h, 24kg	
4260414594182		4260414595479		4260414594199	

							
G/110	V3	G/1301	V3	G/111 re	V1	G/1300	V1
Engel „Jugend XL“		Engel „Jugend L“		Engel Jugend S		Engel „Jugend XS“	
29x55x39h, 37kg	4260414590924	28x45x37h, 25kg	4260414594618	22x25x25h, 7kg	4260414590931	24x15x19h, 4kg	4260414594601

					
G/108	V3	G/109	V3	G/114	V2
Engel „Junge“		Engel „Mädchen“		Engel „Jugend auf Kugel“	
24x30x35h, 22kg	4260414590900	24x30x35h, 22kg	4260414590917	21x29x35h, 8kg	4260414590062



G/1310 V1
 Engelbüste "ADAM"
 14x20x16h, 3kg 4260414595653



G/1311 V1
 Engelbüste "ABRIEL"
 12x23x14h, 3kg 4260414595660



G/33 V1
 Engelbüste. rechte Hand
 32x16x20h, 5,5kg 4260414590269



G/34 V1
 Engelbüste „Beide Hände“
 28x14x18h. 4,5kg 4260414590276



G/123 V2
 Engelbüste auf Kissen
 32x20x25h, 16kg 4260414591020



G/102 V1
 Engelbüste „Auf Kissen gebettet“
 15x26x19h, 5kg 4260414597077



G/133
NIKE griechische Siegesgöttin
43x62x99h, 73kg,



V4 R/133 (ART-ROST) V4
NIKE griechische Siegesgöttin
43x62x99h, 73kg, 4260414597008



R/1140 (ART-ROST)
33x33x58h, 24kg

V3
4260414596988



R/1150 (ART-ROST)
41x41x67h, 43kg

V3
4260414596995

G/1140 Amphore schlicht
33x33x58h, 24kg

V3
4260414596544

G/1150 Amphore schlicht
41x41x67h, 43kg,

V3
4260414596551



G/1112 französische Lilie
30x16x48h, 5kg

V2
4260414594755

R/1112 französische Lilie
„ART ROST“, 30x16x48h, 5kg

V2
4260414597022



G/887 Birne mit Gesicht
33x33x56h, 60kg

4260414596872 V3

G/1111 VT. Schale/Blatt
45x45x17h, 15kg







4260414594335 V3



G/888 V3
Altes Gesicht, 1 Auge,
incl. Eisenstange-gedreht, 1mtr 4260414596681

G/889 V3
Altes Gesicht, 2 Augen
incl. Eisenstange-gedreht, 1mtr. 4260414596698

(V3 aufgrund der Stange)

				
<p>G/1420 „Schmetterlingstreiff“ 18x39x32h, 23kg</p>	<p>V3 4260414596094</p> <p>G/1418 „Muschelkugel“ 28x28x23h, 20kg</p> <p>V3 4260414596100</p>			
				
<p>G/1412 Rosenkugel 23x23x21h, 15kg</p>			<p>V2 4260414594250</p>	
				
<p>G/1414 Blütenkugel 24x24x21h, 15kg</p>			<p>V2 4260414594267</p>	
	<p>G/1227 Zapfen, 18x18x37h. 18kg</p>	<p>V3 4260414595899</p> <p>V2 4260414597299</p> <p>G/1225 Zapfen „Ornament“ 23x23x49h, 25kg</p> <p>V3 4260414595837</p>		



G/1250 V1
HERZ, „S“
30x14x30h, 9kg Bepflanzung 4260414595264



G/1251 V3
HERZ, „X“
56x16x50h, 27kg Bepflanzung 4260414595288



G/1255 V3
HERZ in HERZ
18x47x55h, 18kg 4260414596438



G/1260 V3
DoppelHerz, grobe Struktur
13x45x43h, 14kg 4260414595301



G/1270 V3
PflanzHerz, grobe Struktur, Bepflanzung
17x45x40h, 15kg 4260414595325



G/1241 V3
Flamme
40x20x65h, 33kg 4260414595349



G/60, Schmetterling, kl. 13x20x2,5h, 1kg, 4260414596032,	V1	G/61, Schmetterling, groß 25x40x3h, 2kg, 4260414596049,	V1	G/9 Herz mit Rose 26x24x9h, 6kg 4260414596292	V1	G/12 Herz/Ornament gr. 16x17x9h, 2kg 4260414595646	V1	G/11 Herz/Ornament klein 13x13x6,5h, 1kg 4260414595639	V1
---	----	--	----	--	----	---	----	---	----



G/903 Kreuz „ROSE“ 22x13x5h, 0,5kg	V1	4260414595721	G/905 Kreuz „Engel“ 22x15x8h, 1kg	V1	4260414595745	G/904 Kreuz „Blume“ 22x13x5h, 0,5kg	V1	4260414595738
--	----	---------------	---	----	---------------	---	----	---------------





<p>B/998, Wanddeko, „BLÜTE“ (art bronze) D36x5h, 7kg</p> <p style="text-align: right;">V1 4260414596018</p>	<p>B/999 Wanddeko, „Orient“ (art bronze) D46x5h, 13kg</p> <p style="text-align: right;">V2 4260414596025</p>
---	--



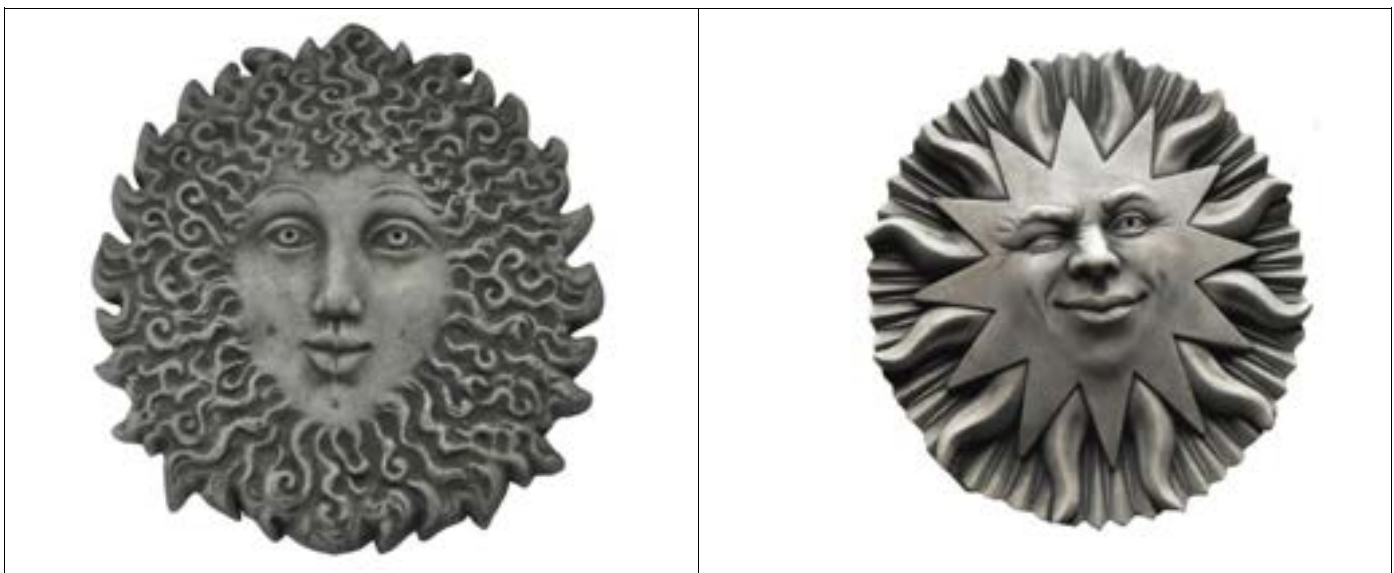

<p>B/42 (art bronze) D40cm, 6kg Sonne/Mond groß 4260414590412</p> <p style="text-align: right;">V1</p>	<p>G/42 D40cm, 6kg 4260414590405</p> <p style="text-align: right;">V1</p>	<p>B/43 (art bronze) D28cm, 3kg Sonne/Mond klein 4260414590436</p> <p style="text-align: right;">V1</p>	<p>G/43 D28cm, 2kg 4260414590429</p> <p style="text-align: right;">V1</p>
--	---	---	---



<p>G/99, „Super Sonne“ D43cm, 7kg</p> <p style="text-align: right;">V2 4260414590801</p>	<p>G/39 „Sonne, Auge zu“ D38cm, 4kg</p> <p style="text-align: right;">V1 4260414590382</p>
--	--

							
KNOLLENNASE V1 23x25x15h, 4kg incl. Hände, incl. Halter		CLOWN V1 23x25x15h, 4kg incl. Hände, incl. Halter		GLATZE V1 23x25x15h, 4kg incl. Hände, incl. Halter		BAUER V1 23x25x15h, 4kg incl. Hände, incl. Halter	
G/500	4260414592492	G/501	4260414592508	G/502	4260414592515	G/503	4260414592522
				G/508, Löwenkopf groß, 50x35x 18kg 4260414592577 v3			
HEXENKOPF V1 23x25x15h, 4kg incl. Hände, incl. Halter		GARGOL V1 23x25x19h, 8kg incl. Hände, incl. Halter					
G/504	4260414592539	G/505	4260414592546				
		B/505	4260414594144				
							
				G/506 FROSCH apstrakt-Kantenhocker V2 25x26x31h, 7kg 4260414592553			
							
H/215 V3 ½ Holzfass, ca. 80 x 40h. gebraucht, Whiskey oder Wein		4260414595172 „Auf Anfrage“		G/5000 V1 Hände Ersatz-Set			

		
<p>G/895 V2 24x22x35h. 10kg 4260414596735</p>	<p>G/896 V1 16x16x22h. 3kg 4260414596742 Damenkopf klein zur Bepflanzung</p>	<p>G/893 V2 Kopf m. Rosenschal, zur Bepflanzung 26x26x34h, 17kg 4260414594595</p>

	
<p>G/711, Herta „Auf dem Badetuch“ V3 60x26x42h, 25kg 4260414593406</p>	<p>G/710 Herta „Die Dame“ V3 60x26x42h, 25kg 4260414593390</p>
	<p>G/717 Herta „Die Balerina“ V3 35x30x60h, 22kg 426041459667</p>



G/283
„Jonas“
43x29x47h, 25kg

V3

4260414594366



G/284
„Madline“
40x30x45h, 25kg

V3

4260414594373



G/256
„Waldkind mit Igel“
24x25x38h, 12kg

V2

4260414597268



G/255
„Waldkind mit Eichhörnchen“
23x27x39h, 13kg

V2

4260414597251



G/261 V1
„Lisa“ 25x20x36h. 8Kg
4260414591563

G/262 V1
„Franz“ 25x20x36h, 8kg
4260414591570



G/245 V1
„Sophie“ 15x22x33h, 7kg
4260414591464

G/244 V1
„Jan“ 16x22x35h, 7kg
4260414591457

Holzbank klein“ V2
41x17x23h, 2kg

H/244-45 V2
4260414591471



G/242 V3
„Hans“ 35x20x47h, 15kg
4260414591426

G/243 V3
„Marie“ 35x20x47h, 15kg
4260414591433

„Holzbank groß“ V3
50x25x31h. 4Kg (sitz 13h.)

H242-43 V3
4260414591440



G/290 V3
Kinder mit Vogelhaus, 3 teilig
54x35x135h, 94kg,
4260414596117



G/291 V4
Knopf-Kinder, Junge
23x23x99h, 25kg,
4260414596155

G/292 V4
Knopf-Kinder, Mädchen
23x23x99h, 25kg,
4260414596162



G/247 „Luise“ 30x27x42h, 20kg	V3 4260414591501	G/248 „Paul“ 29x35x43h, 22kg	V3 4260414591518	G/275 „Charlotte“ 29x33x44h, 26kg	V3 4260414591693
-------------------------------------	---------------------	------------------------------------	---------------------	---	---------------------



G/1212 Laurin 22x27x52h, 10kg 4260414594434	V2	G/1213 Alva 25x27x50h, 10kg 4260414594441	V2	G/251 Julian&Lea 20x20x51h. 15kg^ 4260414591549	V2	G/285 Der Kuss 33x20x50h, 21kg 4260414594380	V3
---	----	---	----	---	----	--	----



G/249 „Anna“ 50x30x34h, 28kg	V3 4260414591525	G/274 „Daniel“ 50x30x31h, 27kg	V3 426041459168
---------------------------------	---------------------	-----------------------------------	--------------------



G/184 V4
 Buddha, **102h**,
 mit Riss
 49x64x102h, 180kg
 4260414596483

G/183 V3
 Buddha, **85h**,
 ohne Riss
 30x40x85h, 110kg
 4260414591235

G/182 V3
 Buddha, **66h**,
 mit Riss
 43x35x66h, 40kg
 4260414591228

G/181 V3
 Buddha, **50h**
 mit Riss
 33x26x50h, 26kg
 4260414591211

G/180 V2
 Buddha, **39h**
 ohne Riss
 26x20x39h, 13kg
 4260414591204

G/231 V1
 Buddha, **29h**
 mit Riss
 19x15x29h, 5kg
 4260414595424

G/230 V1
 Buddha, **24h**
 mit Riss
 15x11x24h, 3kg
 4260414595417



G/169
Buddha „Khmer“ 130
60x70x130h, 350kg

V4

4260414596490



G/202
Buddha/Mönch, stehend groß
36x36x100h, 125kg

V4

4260414596902



2 GRÖßEN

G/215 V3
Buddha/Lotus/Schale **GROß**
45x45x80h, 85 kg
4260414594472





G/216 V3
Buddha/Lotus/Schale **KLEIN**
27x37x65h, 38 kg
4260414597398



G/193
Buddha, „Thai“
50x35x74h, 55kg

V3

4260414591297

					
<p>G/170 Buddha Mangala 20x25x41h, 13kg, 4260414596629</p>	<p>V2 A/170 (ART-ANTHRAZIT) Buddha Mangala 20x25x41h, 13kg, 4260414596636</p>	<p>V2 R/170 (ART-ROST) Buddha Mangala 20x25x41h, 13kg, 4260414597428</p>			
					
<p>G/177 Buddha mit Koi 35x25x35h, 22kg</p>	<p>V3 4260414591198</p>	<p>G/203 Mönch auf Kissen 23x33x35h, 17kg</p>	<p>V3 4260414595769</p>		
					
<p>G/205 Mönch, klein 17x16x19h, 4kg</p>	<p>V1 4260414591372</p>	<p>G/209 Mönch 19x21x31h, 10kg</p>	<p>V2 4260414594779</p>	<p>G/220 Buddha, Büste 20x12x29h, 5kg</p>	<p>V1 4260414595431</p>

		
<p>G/1201 V3 Moai, mittel 28x28x63h, 40kg 4260414596063</p>	<p>G/1200 V3 Moai, groß, 25x27x76h, 60kg 4260414594342</p>	<p>G/1209 V4 Moai, XL, 40x52x100h, 170kg 4260414596810</p>
		
<p>G/1206 V2 Moai, klein 22x24x40h, 15kg 4260414594670</p>	<p>G/1710 V3 Yukimi Laterne, 80, 2teilig 55x55x80h, 70kg 4260414596797</p>	<p>G/1711 V4 Kasuga Laterne 128, 2teilig 50x50x128h, 135kg 4260414596803</p>



G/1700
Ganesha kl
43x30x60h, 70kg

V3

4260414596247



G/1702
Ganesha, gr.
30X30x69h,80kg

V3

4260414596254



G/1703
Ganesha, groß stehend
x42x98h, 74kg

V4

4260414596865



G/1704
Ganesha, klein mit Buch
33x40x57h, 60kg

V3

4260414596940



G/669 V3
Torwächter, groß mit Flügeln
37x47x60h, 52kg 4260414596148



G/669 V3 Torwächter, groß m.Flügel 37x47x60h, 52kg 4260414596148	G/763 V3 SOCKEL BU71 30x30x71h, 75kg 4260414596780
---	---



R/669 (ART-ROST) V3
Torwächter, groß mit Flügeln
37x47x60h, 52kg 4260414596322

A/669 (ART-ANTHRAZIT) V3
Torwächter, groß mit Flügeln
37x47x60h, 52kg 4260414596339



G/662
Gargol, eine Hand am Bein
22x29x29h, 13kg

V2

4260414595981

G/663
Gargol, Hände unterm Kopf
22x29x29h, 13kg,

V2

4260414595998



G/606
Gargol mit Schwert
25x24x32h, 13kg

V2

4260414595905

G/661
Tor-Mauerwächter
28x28x27h. 10Kg

V3

4260414593260



G/670
Mauerwächter 2Hände
24x18x19h, 8kg
4260414593307

V1

G/671
Mauerwächter 1Hand
26x18x19h, 8kg
4260414593314

V1

G/675
Mauerw. Horn“re
17x24x19h, 6kg
4260414594687

V1

G/676
Mauerw. Horn“ li
17x24x19h, 6kg
4260414594694

V1



G/601re

V3 KettenHund, sitzend, schaut n. Rechts 26x42x47h, 30kg
4260414594465



G/600
KettenHund, liegend
45x35x40h, 32kg

4260414593062

V3



G/601 li

V3 KettenHund, sitzend schaut n. links ORIGINALE 26x42x47h, 30kg
4260414593079

**2 GRÖßEN**

G/602 TorMauerWächter,
Hand am KOPF
32x32x43h, 21kg
4260414593086 V3



G/608 V3
Drache „Qulux“
36x33x46h, 32kg
4260414596919

**2 GRÖßEN**

G/603 TorMauerWächter
Hand am KNIE 32x32x42h,
21kg 4260414593093 V3

G/604 Hand am KOPF KLEIN
20x22x28h,6kg 4260414597329 V2

G/605 Hand am KNIE KLEIN
20x22x28h,6kg 4260414597336 V2



G/763 Sockel, BU71
30x30x71h, 75kg

V3
4260414596780

G/762 Sockel, HOMI
30x30x38h 37kg

V3
4260414596773



G/730 h31cm
24x24x31h, 28kg 4260414593437

V3
G/732 h23cm
24rx23h,18kg

V2
4260414593451

G/1230 h40
25x25x40h39kg 4260414595363

V3

		
<p>G/564 V1 „Stinkefinger“ 18x18x25h, 7kg 4260414592829</p>	<p>G/563 V1 „Beide Hände“ 26x16x23h, 7kg 4260414592812</p>	<p>G/575 V1 „Finger im Ohr M“ 16x20x28h, 9kg 4260414592928</p>
		
<p>G/577 V1 „Hose“ 24x21x24h, 8kg 4260414592942</p>	<p>G/578 V2 „OK“ 22x24x36h, 17kg 4260414594489</p>	<p>G/568 V2 „Finger Nase X“ 26x20x32h, 13kg 4260414592867</p>
		
<p>G/560 V1 „Blumen“ 14x15x19h, 3kg 4260414592782</p>	<p>G/561 V1 „RUM“ 15x15x20h, 3kg 4260414592799</p>	<p>G/562 V1 „Striptease“ 23x11x20h, 3kg 4260414592805</p>

		
<p>G/569 V2 „Stinkefinger...XL“ 20x23x38h, 20kg 4260414592874</p>	<p>G/566 V2 „Keule“ 25x30x30h, 14kg 4260414592843</p>	<p>G/567 V2 „Ohr XL“ 26x25x26h, 14kg 4260414592850</p>
		
<p>G/559 V1 „Nase S“ 16x13x21h, 4kg 4260414592775</p>	<p>G/570 V1 „Ohr S“ 15x14x18h, 4kg 4260414592881</p>	<p>G/558 V1 „Finger Teufelchen“ 18x18x25h, 7kg 4260414592768</p>
		
<p>G/540 V1 Steingesicht, Spitzer Kopf 18x19x14h, 7kg 4260414592720</p>	<p>G/541 V1 Steingesicht, Auge zu 20x18x12h, 7kg 4260414592737</p>	<p>G/542 V1 Steingesicht, Lachend 20x18x12h, 7kg 4260414592744</p>



1

Haussperling, Edelrost

Art.-Nr. 55001

Maße: H 14 x B 14 cm



2

Heckenbraunelle, Edelrost

Art.-Nr. 55002

Maße: H 10 x B 20 cm



3

Nachtigall, Edelrost

Art.-Nr. 55003

Maße: H 21 x B 15 cm



4

**Amsel klein, Edelrost
mit Standsockel**

Art.-Nr. 55004

Maße: H 10 x B 25 x T 9 cm



5

**Taube, Edelrost
mit Standsockel**

Art.-Nr. 55005

Maße: H 15 x B 29 x T 9 cm



6

Rotkehlchen, Edelrost

Art.-Nr. 55006

Maße: H 25 x B 16 cm



7

**Schmetterling
mit Erdspieß, Edelrost**

Art.-Nr. 55007

Maße: H 96 x B 16 T 11 cm



8

**Eule klein mit Erdspieß,
Edelrost**

Art.-Nr. 55008

Maße: H 102 x B 14 cm



9

**Eule groß mit Erdspieß,
Edelrost**

Art.-Nr. 55009

Maße: H 110 x B 18 cm



10

**Adler mit Erdspieß,
Edelrost**

Art.-Nr. 55010

Maße: H 122 x B 18 cm



11

Uhu Paar, Edelrost

Art.-Nr. 55011

Maße: H 30 x B 33 x T 10 cm



12

Katze, Edelrost

Art.-Nr. 55012

Maße: H 34 x B 27 x T 11 cm



13

**Schmetterlinge
am Stab,
Edelrost**

Art.-Nr. 55013

Maße: H 80 x B 30 x T 12 cm



14

**Froschkönig,
Edelrost**

Art.-Nr. 55014

Maße: H 28 x B 18 x T 9 cm



1

Herz mit Hirschkopf auf Sockel, Edelrost

Art.-Nr. 55015
Maße: H 22 x B 25 x T 8 cm



2

Doppel-Herz, Edelrost

Art.-Nr. 55016
Maße: H 26 x B 38 x T 10 cm



3

Krone klein, Edelrost

Art.-Nr. 55017
Maße: H 18 x B 15 x T 15 cm

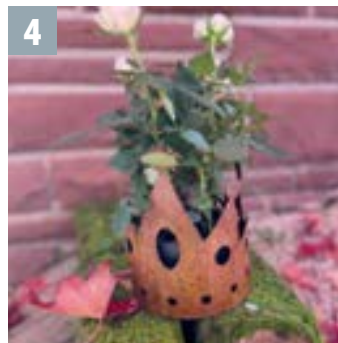

4

Krone groß, Edelrost

Art.-Nr. 55018
Maße: H 27 x B 22 x T 22 cm



5

Eule groß mit Erdspieß, Edelrost

Art.-Nr. 55019
Maße: H 120 x B 24 cm



6

Herz Hund mit Erdspieß, Edelrost

Art.-Nr. 55020
Maße: H 104 x B 30 cm



7

Herz Katze mit Erdspieß, Edelrost

Art.-Nr. 55021
Maße: H 104 x B 30 cm



8

Herz Duo mit Erdspieß, Edelrost

Art.-Nr. 55022
Maße: H 110 x B 30 cm



9

Herz Hirsch mit Erdspieß, Edelrost

Art.-Nr. 55023
Maße: H 100 x B 25 cm



10

Schild Willkommen Engel mit Erdspieß, Edelrost

Art.-Nr. 55024
Maße: H 98 x B 30 cm



11

Schild Willkommen Kreis, Edelrost

Art.-Nr. 55025
Maße: H 25 B 25 cm



12

Schild Hereinspaziert Hirsch, Edelrost

Art.-Nr. 55026
Maße: H 30 x B 30 cm



13

Willkommenschild mit Standfuß, Edelrost

Art.-Nr. 55027
Maße: H 80 x B 30 x T 20 cm



14

Hausperling & Heckenbraunelle auf Ast mit Stab, Edelrost

Art.-Nr. 55028
Maße: H 18 x B 32 x T 4 cm



2024



art - decor - keramik

www.art-decor-keramik.de

Inh. Armin Bornheimer • Breslauer Str. 5 • 46342 Velen-Ramsdorf • Tel.: +49 (0) 28 63 / 73 75

Fax: +49 (0) 28 63 / 76 15 57 • Mobil: +49 (0) 171 / 6 59 24 29 • Mail: art-decor-keramik@t-online.de