



JUNIOR

CELL™

INSTRUCTIONS

ENGLISH

ENGLISH

INTRO:

Congratulations on your purchase of the Junior CELL Knee Protection System by Asterisk. Please read thoroughly. Please follow the instructions and recommendations below to insure proper function and working order.

INSPECTION:

It is important to inspect the general condition prior to each use. If any signs of wear and tear are present, or if any areas of concern are noticed, discontinue use and call Asterisk at 951-268-6790.

Symmetri-Glide Hinge

Check the hinges for proper motion, loose screws, rivets or links. Check the extension limiter mechanism.

A.N.I. Frame

Check the frame for cracks and structural continuity.

D.A.U. Cuff

Check that the Dual Adjustment Cuff pieces are attached securely to the A.N.I. Frames as well as checking for loose screws or rivets

Anti-Rotation Tether

Check for tears in the straps. Check the smash rivet to make sure it is still secure.

CARE



HAND WASH



NO BLEACH



AIR DRY

The following recommendations are general guidelines to help maintain proper working order and prevention of premature wear and tear to the Junior CELL Braces. The frequency of maintenance depends on how often and for which activity the braces are used. We strongly recommend sending them in at least every 12 to 18 months for check up/service. The A.N.I. Frame, and frame padding should be hand-washed using mild detergent and allowed to air dry. Because the brace is completely water-tolerable, it can be washed without disassembling it.

WARRANTY

IMPORTANT! To be eligible for this warranty, you must retain your original receipt. This warranty is intended for the original purchaser and is non-transferable.

Warranty servicing is valid only in country of purchase. Service charges will apply if serviced outside the country of sales origin. Warranty void on all third party purchases.

Asterisk will repair or replace (at its discretion) any Junior CELL Knee Protection System, if it is determined by Asterisk to be defective in materials or workmanship according to the following:

Frames and Hinges: Covered one year from date of purchase

D.A.U. Cuffs, Straps, Padding, Patella Cups: Covered for six months from date of purchase.

To obtain repair or warranty service, contact your local Asterisk distributor.

The warranty set forth above shall not apply if the device has been subjected to unusual or abusive treatment, misuse, accident, or negligence by the purchaser. Also, any consequential and incidental damages are not covered under this warranty. There are no other warranties extended or implied other than what is written here.

ITEMS INCLUDED

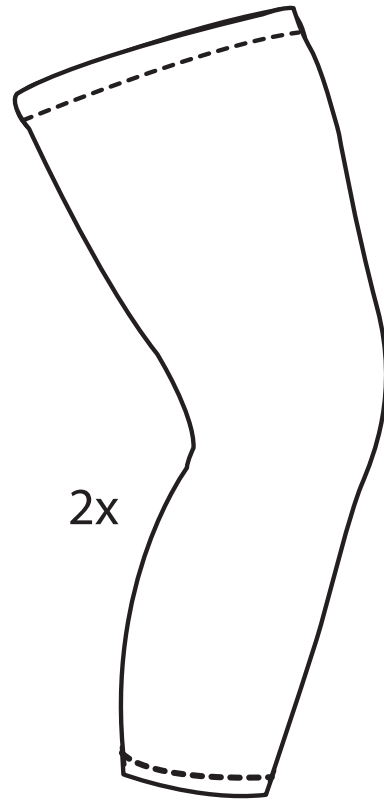
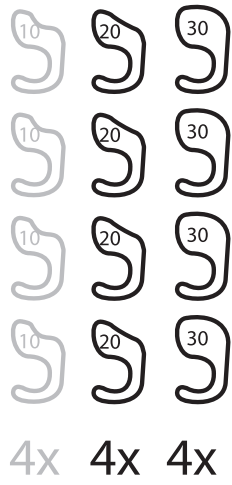

UPON REQUEST

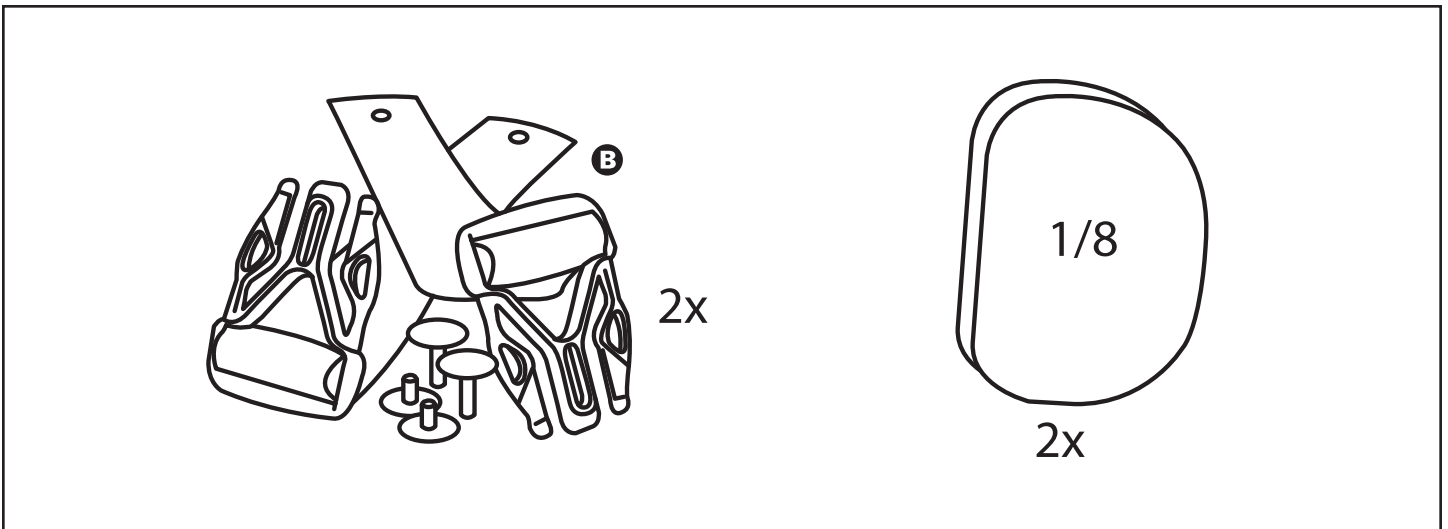

WEARING AND ADJUSTING THE JUNIOR CELL

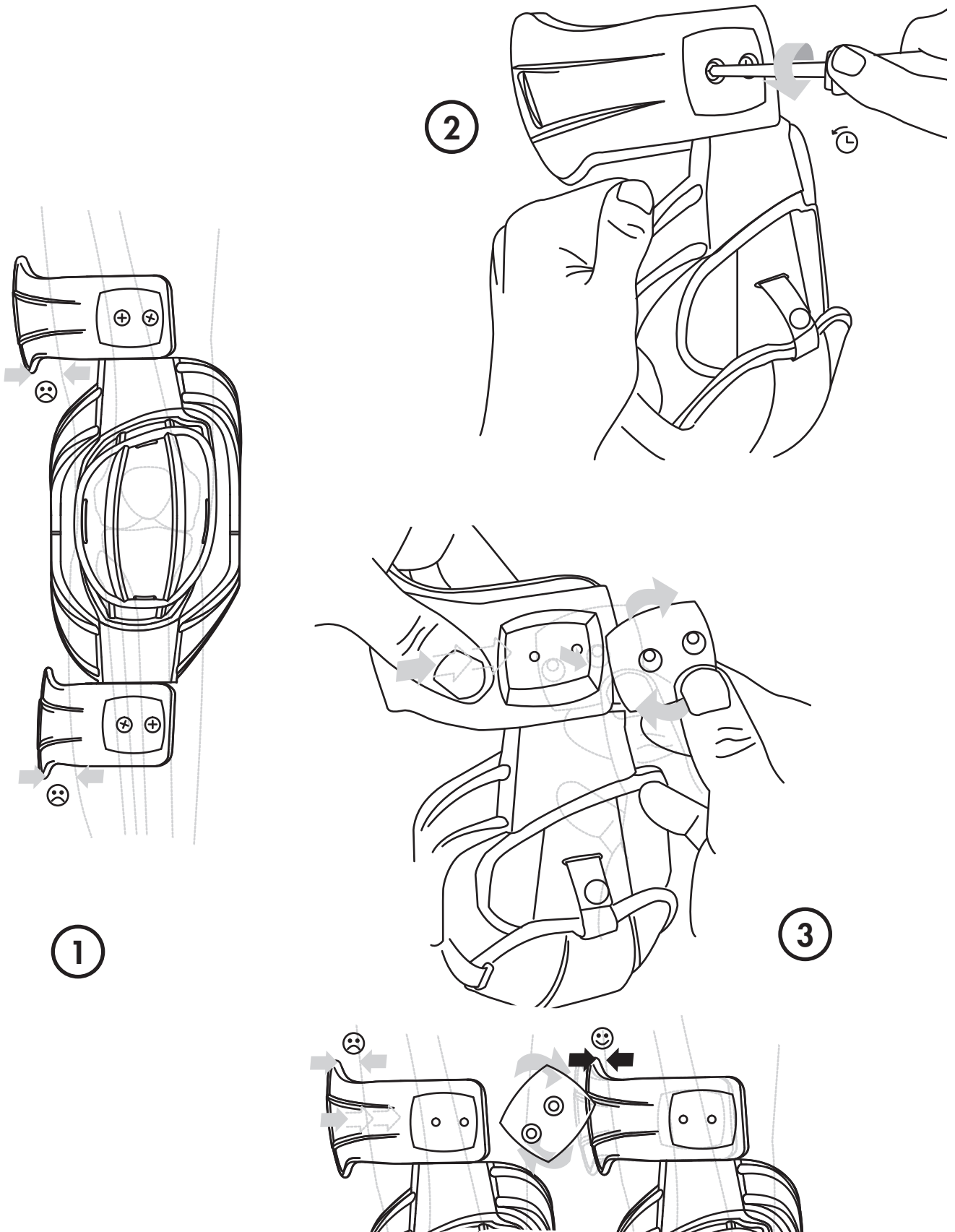

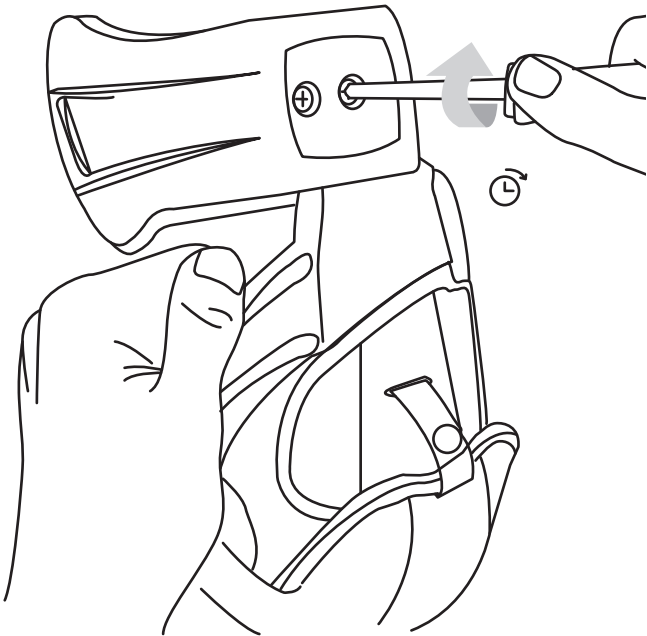

4

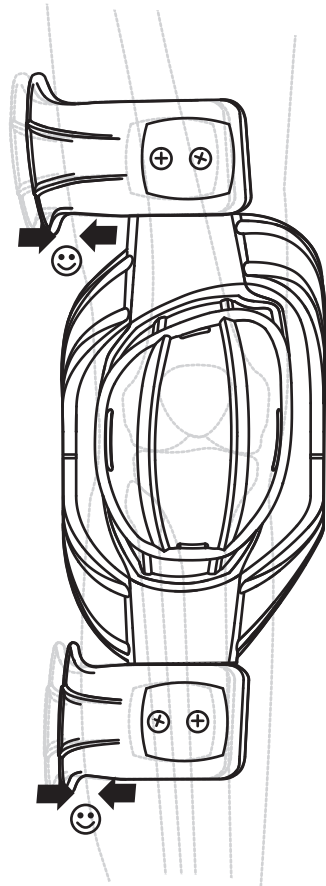

5

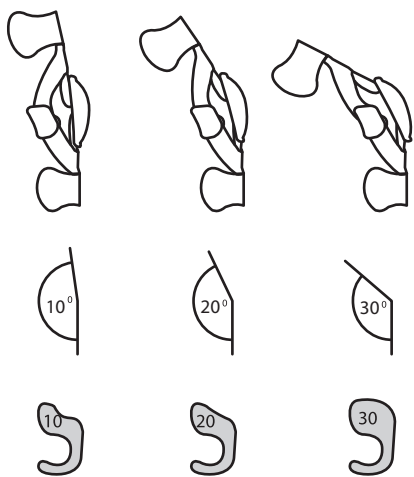
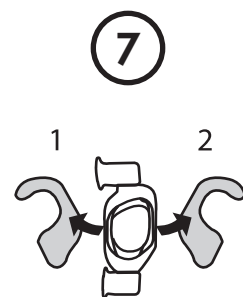
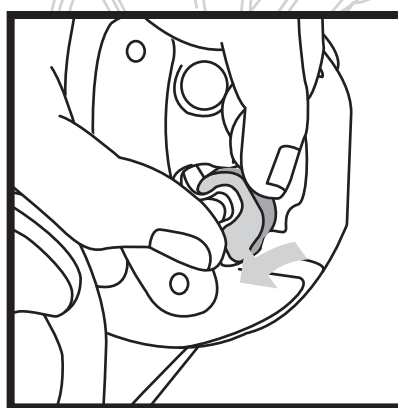
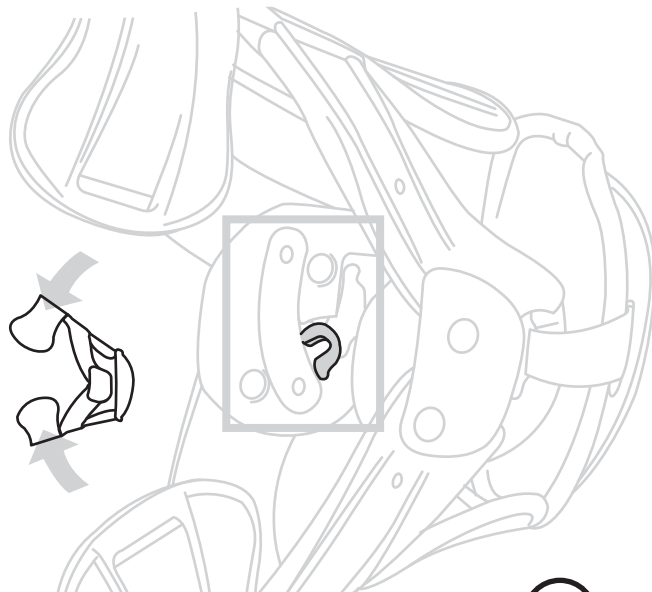
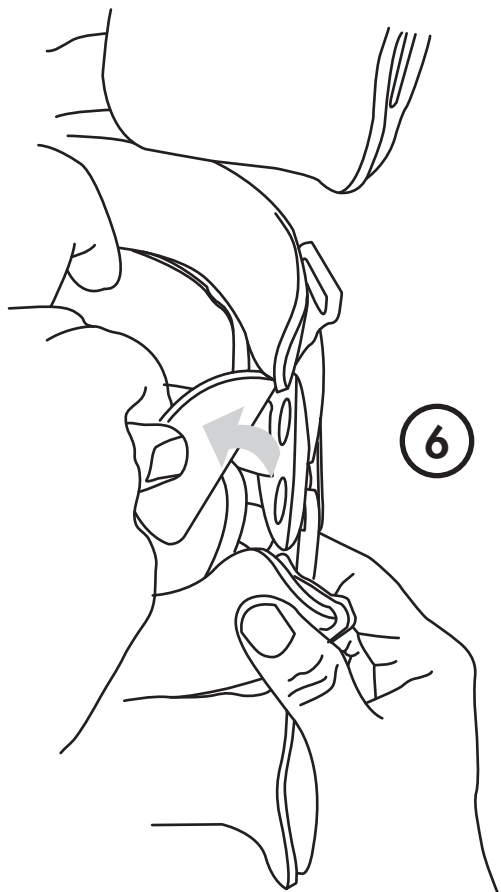

8

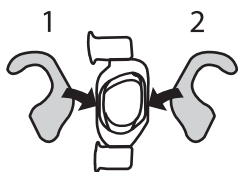
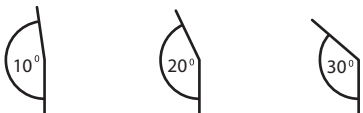

or

UPON REQUEST

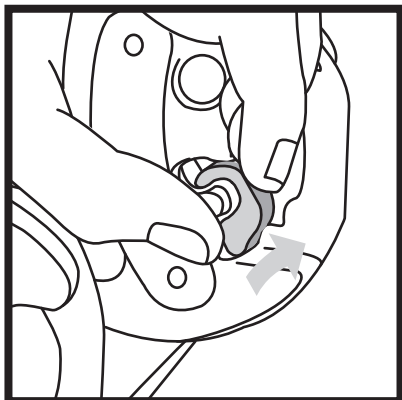
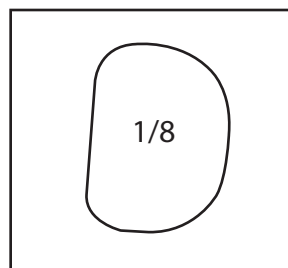

9

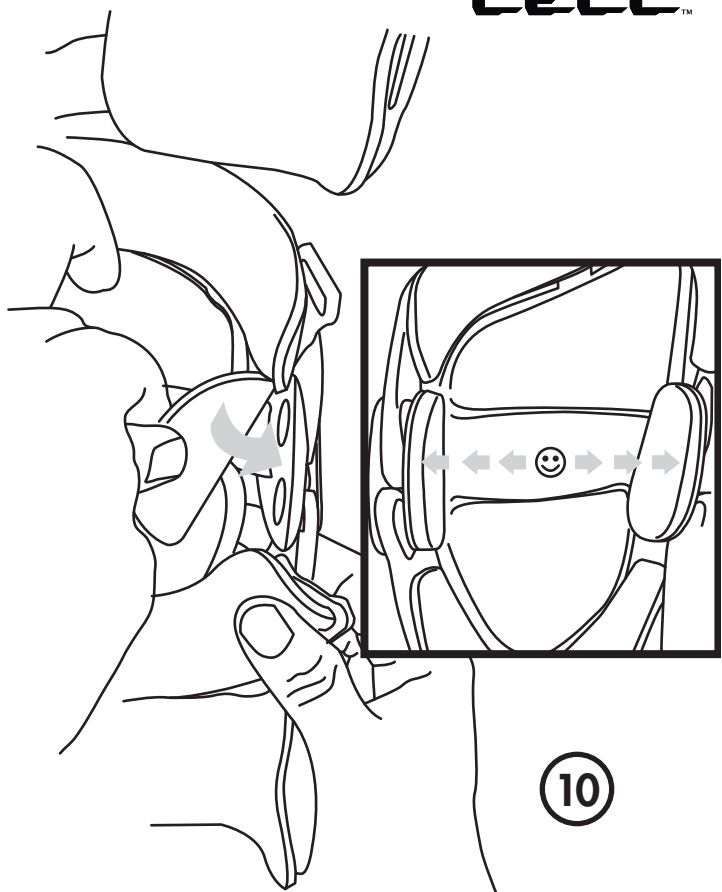

10

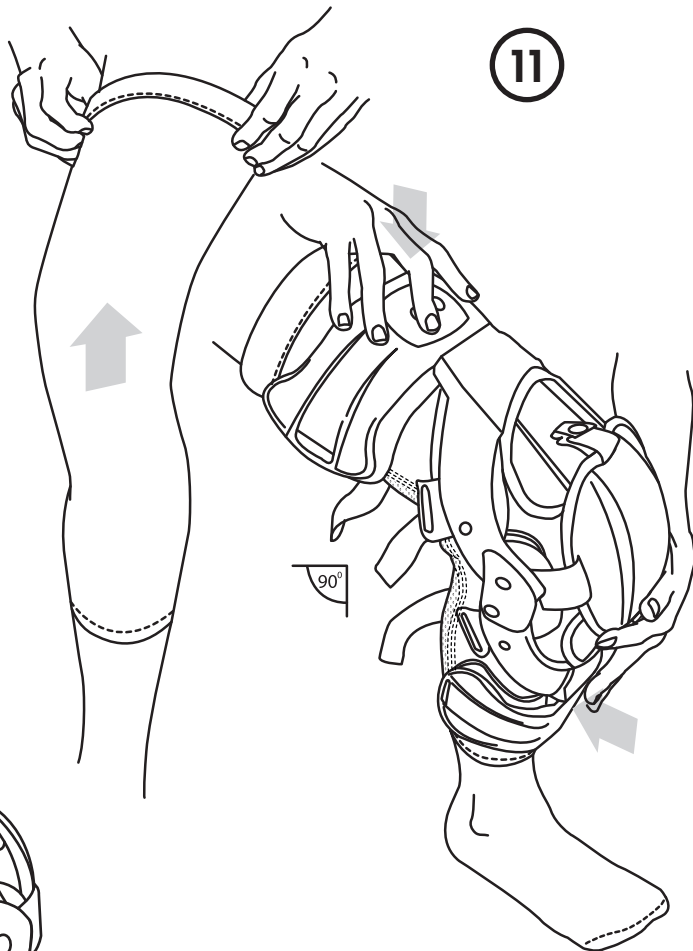

11

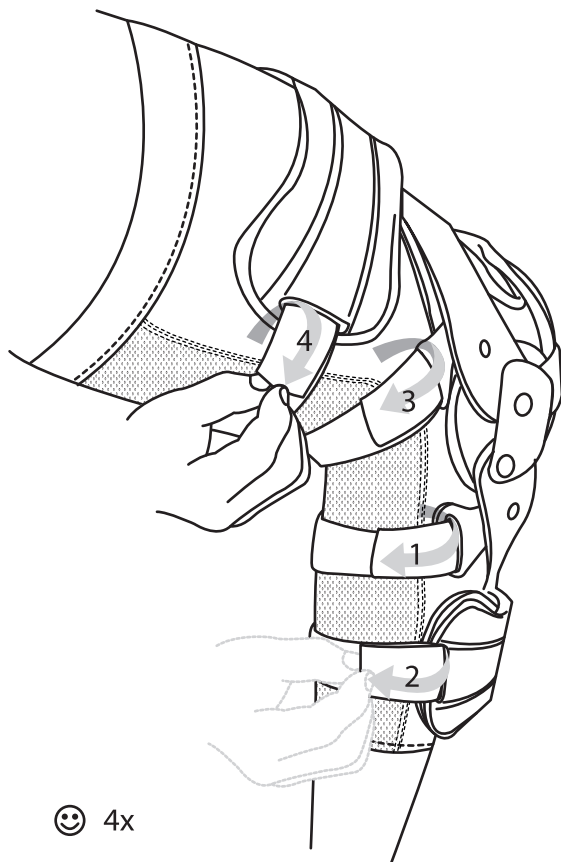

12

☺ 4x

All Illustrations, photographs and specifications in this publication are based on the latest product information available at the time of printing. Asterisk reserves the right to make changes at any time, without prior notice, in prices, colors, materials, specifications and products.

At www.asterisk.com, you'll find virtual product demonstrations, dealer locator, shopping and more. Call 951-268-6790 for more personal information or email us at customerservice@asterisk.com

PROUDLY 
MADE IN **USA**

1478 Davril Circle • Corona, California 92880

AUGUST 2017