

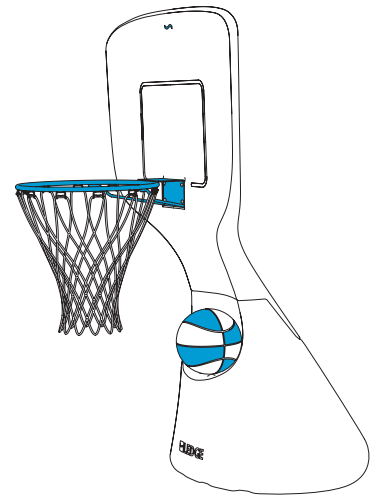

# ASSEMBLY GUIDE FOR HOOPSTR



## IMPORTANT NOTE

**CAREFULLY READ ALL INSTRUCTIONS BEFORE STARTING. ENSURE THERE IS A WATER HOSE NEARBY FOR FILLING OF PRODUCT. CRITICAL STEPS MIGHT BE MISSED RESULTING IN UNSUCCESSFUL ASSEMBLY OR DAMAGE TO THE PRODUCT.**

**2 PERSON ASSEMBLY RECOMMENDED.**

## CONTENTS

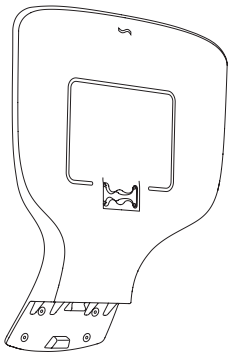

x1 Backboard

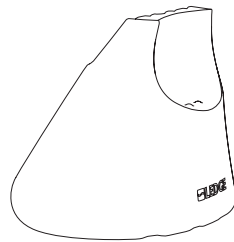

x1 Base

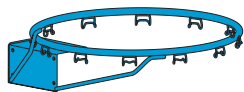

x1 Rim

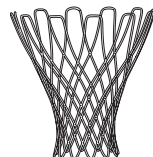

x1 Net



x1 Ball



x5 Screw A\*



x5 Screw B\*



x10 Flat Washer\*



x10 Lock Washer\*



x5 Acorn Nut\*



x1 Allen Wrench

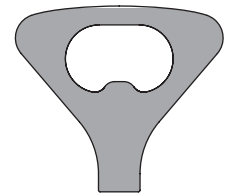

x1 Plug Key

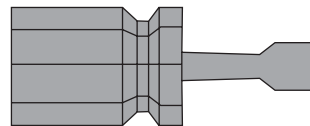

x1 Nut Driver



x1 Ball Pump

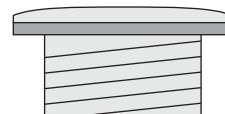

x1 Fill Plug\*\*



x1 Drain Plug\*\*

\* Extra Hardware Included

\*\* Installed in Base

**STEP 1:** Join the backboard to the base.

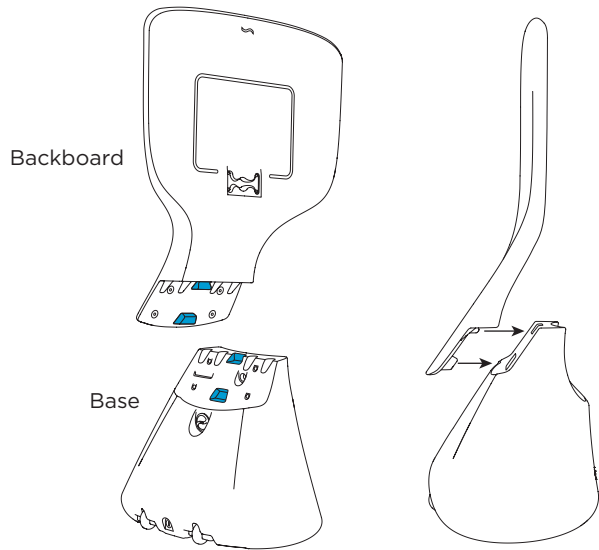

**STEP 2:** Ensure the seam doesn't have gaps. If there are gaps, hit the area between the 4 screw holes with the palm of your hand to properly join the two parts. The backboard should hold itself upright.

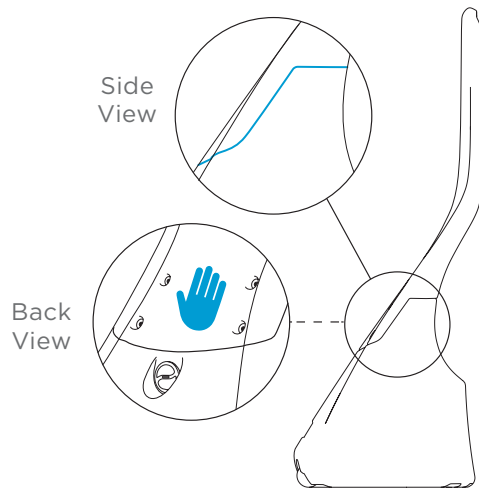

**STEP 3:** Set up 4 screws (A) with a lock washer and a flat washer.

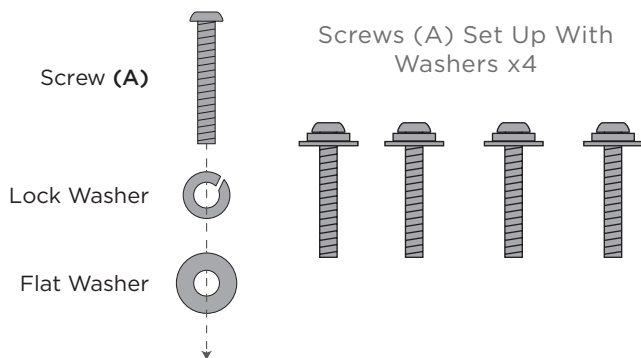

**STEP 4:** Hand tighten the 4 screws with washers, in the following order. Do not fully tighten until all 4 screws are started. Tighten to secure backboard to base.

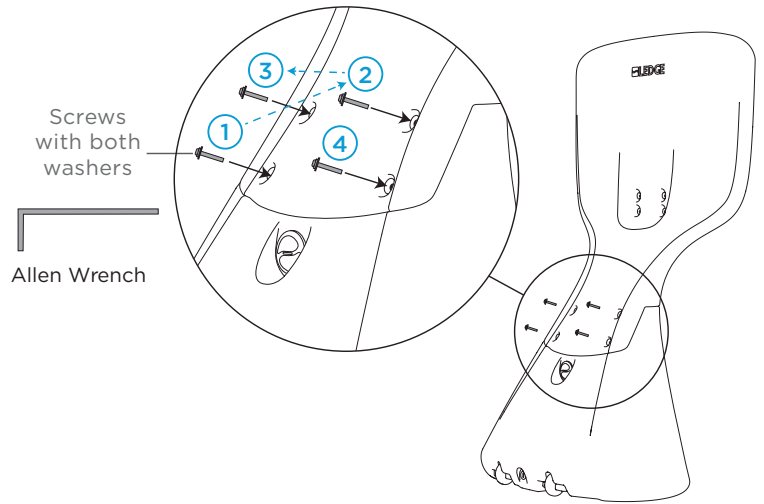

**STEP 5:** Insert one screw (B) into one of the top holes of the rim.

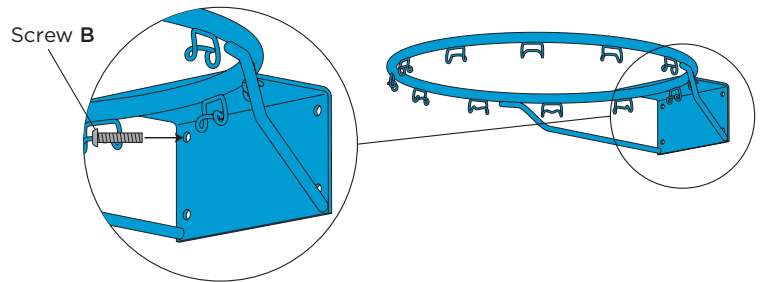

**STEP 6:** Position the rim with the first screw in the front of the backboard as shown. Have flat washers, lock washers, and acorn nuts readily available.

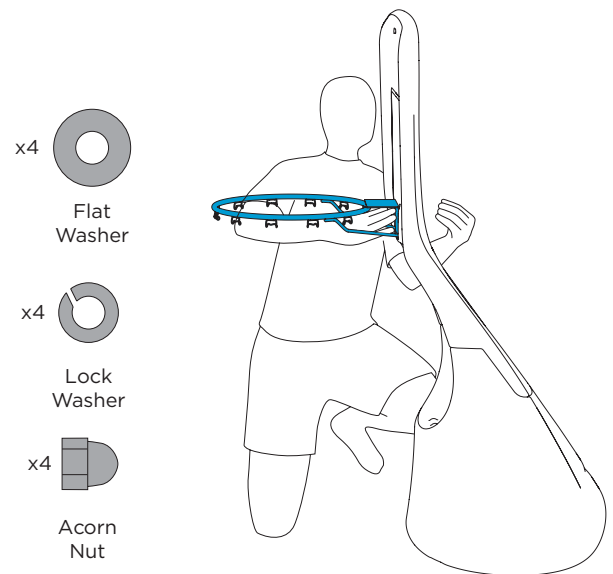

**STEP 7:** While holding the screw and the rim with one hand, insert flat washer, and lock washer from the back of the unit, then hand tighten the acorn nut.

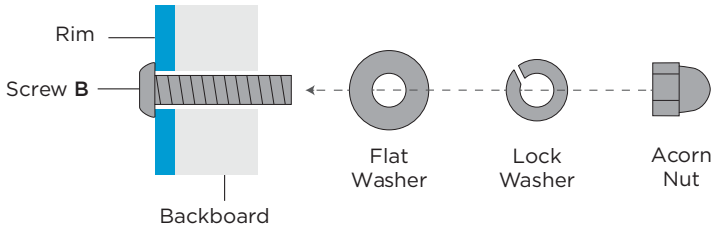

**STEP 8:** Insert 3 screws (B) into remaining rim holes and repeat Step 7. Using the allen wrench to hold the screws in place, tighten the acorn nuts with the nut driver.

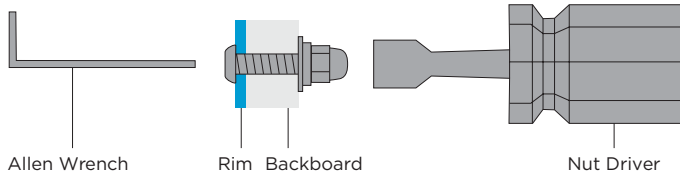
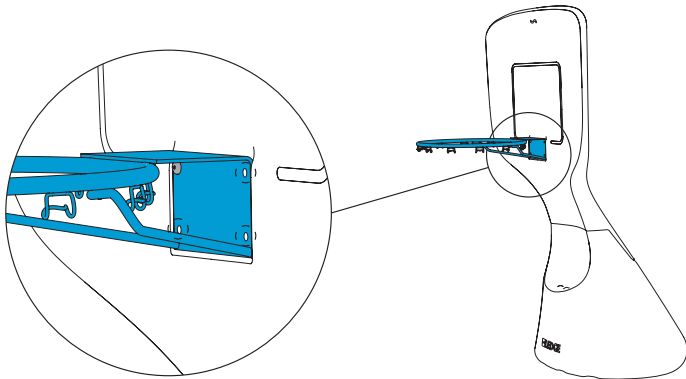

**STEP 9:** Determine the final location for your new Hoopstr. Gently tilt back to engage wheels. Exercise caution when tilting and setting the unit back down.

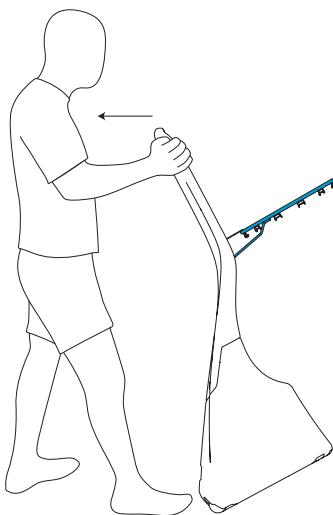

**STEP 10:** Unscrew the fill plug. Use the plug key if necessary.

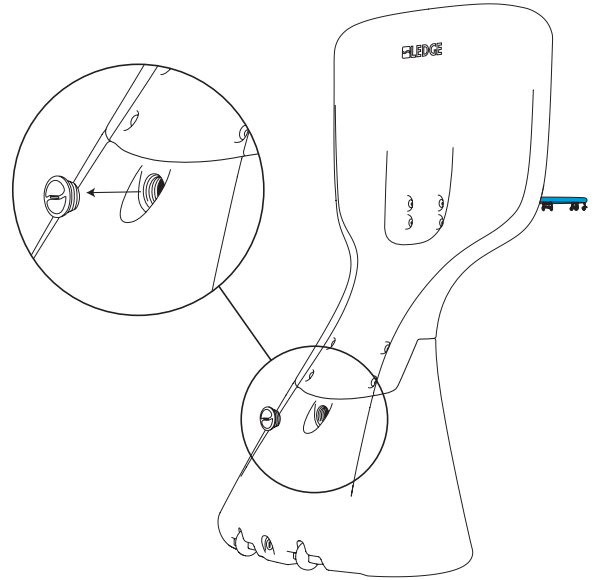

**STEP 11:** Fill the base until it overflows. Then, reinstall the fill plug.

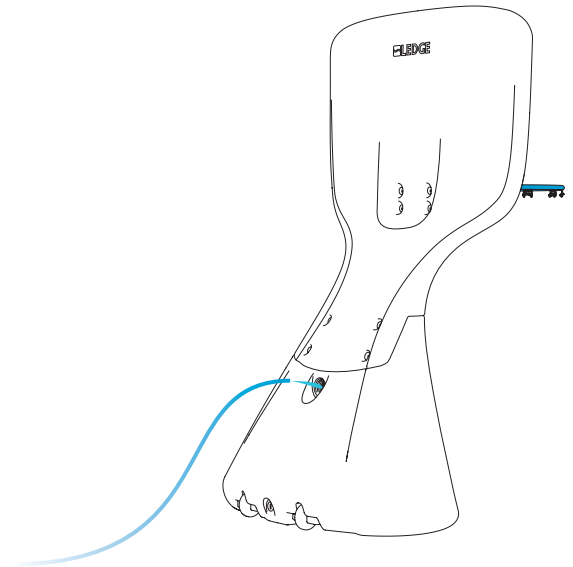

**STEP 12:** Loop the net, starting with the wider end of the net.

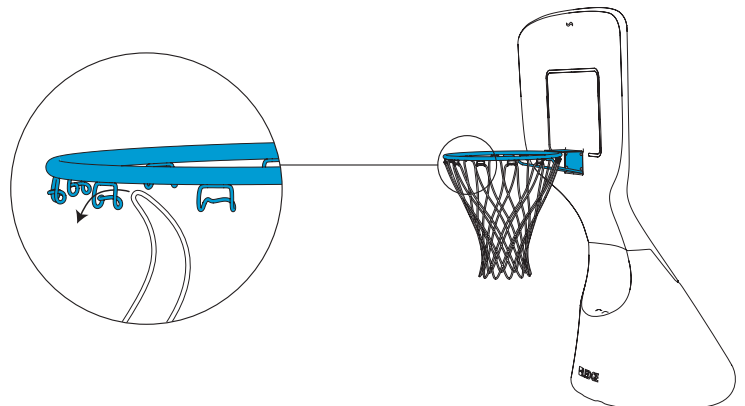

**STEP 13:** Install the pump needle, found in the pump handle. Then, inflate the basketball with the pump.

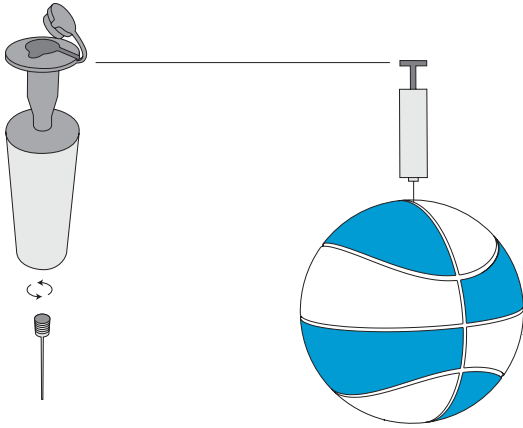

## DRAINING

Unscrew the drain plug using the plug key, which also doubles as a bottle opener.

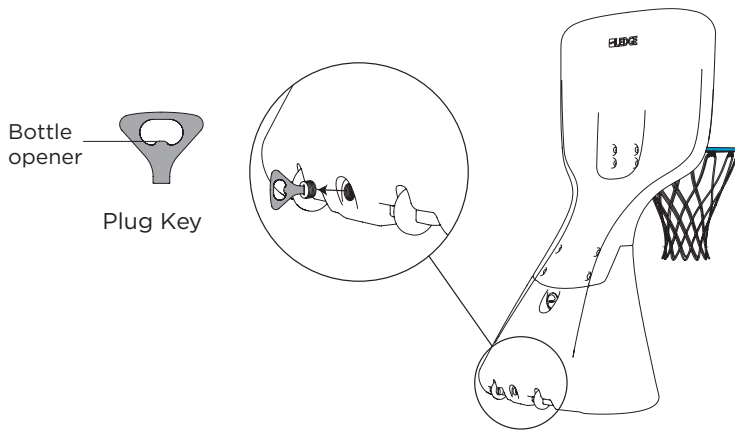

## BALL STORAGE

To maximize ball longevity, take the ball out of the pool and place it in the ball holder for convenient storage.

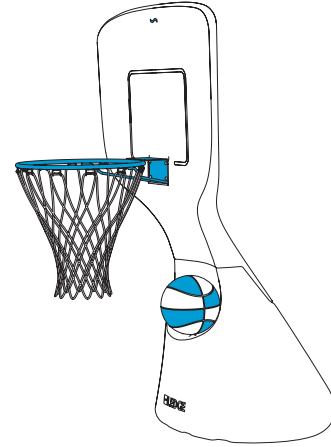

## ROUTINE CLEANING

For routine cleaning, use water and a soft cloth or microfiber towel. For stubborn stains, use mild soap and water with a soft bristle brush.

Should unit require touch up to powder coated rim, please reach out to our customer service team at 888.749.5336.

SHARE YOUR MEANINGFUL MOMENTS WITH US

**#LEDGELIFE**